

**CAROL
BRAND**

Electronic Wire & Cable

FOR SIGNAL TRANSMISSION AND SOUND/SECURITY



Electronic Wire & Cable

This catalog contains in-depth information on the most comprehensive line of copper Electronics products available today for data transmission, sound, security/fire alarm, professional audio and video broadcast.

In a rapidly changing industry with ever-growing demands, General Cable continues to stay ahead of the curve with engineered products that guarantee future performance. Choose from the best cable in its class—Carol® Brand.

Our products are readily available for immediate shipment through our network of authorized stocking distributors and distribution centers.



All information in this catalog is presented solely as a guide to product selection and is believed to be reliable. All printing errors are subject to correction in subsequent releases of this catalog. Although General Cable has taken precautions to ensure the accuracy of the product specifications at the time of publication, the specifications of all products contained herein are subject to change without notice.

GENERAL CABLE, CAROL BRAND, CAROLPRENE, COMMAND SERIES, DEMAND BETTER...EXPECT MORE, FLEXFOIL, LO-CAP, MOISTURE GUARD, ONE COMPANY CONNECTING THE WORLD, PULL-PAC, SMARTWRAP, SPOOL-PAC, SUPERFLEX, WIRE WIZARD and logos are trademarks of General Cable Technologies Corporation.

© 2015, General Cable Technologies Corporation.
Highland Heights, KY 41076
All rights reserved. Printed in U.S.A.

Demand Better... Expect More™ FROM CAROL® BRAND

QUALITY



General Cable is committed to meeting customer requirements through continuous quality improvements. As a significant part of our commitment to quality, General Cable's manufacturing facilities are certified to the ISO 9001:2000 quality standard. Our telecommunications cable manufacturing facility has received TL 9000 quality standards registration as a supplement to the ISO program.

This quality system is based on the ISO 9001 program with added telecommunications-specific performance metrics. We strive to provide value optimization through innovation and quality solutions.

- Our in-house testing capabilities are extensive, with strict adherence to our product specifications as well as industry standards.
- Cables are safety listed and verified.
- Third-party testing labs like ETL and UL are utilized to quantify and confirm our quality and provide final qualification data that sets the foundation for our extended product warranty.
- General Cable products have stood the test of time with proven reliability and performance.

CUSTOMER SERVICE



General Cable is dedicated to customer service and satisfaction. Call our team of professionally trained sales associates at

888-295-5896

with any questions to meet your application needs.

GENERALCABLE.COM

What's New?

WHEN FAILURE IS NOT AN OPTION...CHOOSE EXZEL®

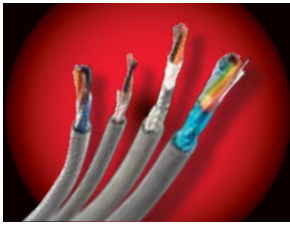

Designed for cruel and unusual punishment, Carol® Brand's EXZEL line is the solution you expect from General Cable. Over 170 years of innovation stand behind the "ruggeddeering" of our high-performing EXZEL line for punishment—it's so tough you can pull, scuff, roll, heat, freeze, bend, throw oil on it—and it still exzels. Not always the case with conventional, round gray PVC electronic cables. We offer a Low-Smoke, Zero-Halogen line, various gauge and conductor sizes, and shielded and unshielded constructions, which have been incorporated into our Electronics Catalog on pages 77-97.

ELECTRONICS PRODUCTS AT YOUR FINGERTIPS



General Cable is pleased to unveil the new Mobile Web Reference Tool for Carol Brand electronic wire and cable. Equipped with a competitor cross-reference and a product directory, the Mobile Web Reference is designed to allow users to quickly and easily find Carol Brand equivalent products and their specs from anywhere, at any time. Never has it been easier to spec Carol cables. By navigating to <http://xref.carol.generalcable.com> on a mobile web browser, a user can click the *Start* button and submit a competing part number to find the Carol Brand equivalent.

LOOKING FOR PLENUM CABLES?



The Carol Electronics Catalog has been revamped, with Plenum Cables now being featured in the Communications & Control Multi-Conductor and Multi-Paired sections. If you're still not sure what you're looking for, please contact our Customer Service associates at 888.295.5896 today!

ARMORED ELECTRONICS PRODUCTS



Carol Brand Electronics products are now offered with an interlock armored option, which provides outstanding mechanical protection and is flexible for easy installation, potentially saving time and money.

Table of Contents

SECTION	PAGES
1 Communication & Control Cable, Multi-Conductor	1-36
Multi-Conductor, Unshielded	2-14
Power-Limited Tray Cable, Unshielded	15
Multi-Conductor, Foil Shield.....	16-21
Multi-Conductor, Foil Shield (CSA).....	22-25
Power-Limited Tray Cable, Foil Shield	26
Multi-Conductor, Spiral Shield	27
Multi-Conductor, Braid Shield	28-31
Multi-Conductor, Foil/Braid Shield	32
Multi-Conductor, Foil & TC Braid Shield	33
Multi-Conductor, Rubber, Unshielded.....	34
Multi-Conductor, Rubber, Braid Shield	35
Multi-Conductor, Carolprene [®] , Braid Shield	36
2 Communication & Control Cable, Multi-Paired	37-61
Multi-Paired, Unshielded	38-40
Multi-Paired, Foil Shield	41-47
Multi-Paired, Foil Shield (CSA).....	48-49
Multi-Paired, Foil Shield, Mid-Cap	50
Multi-Paired, Foil Shield, Lo-Cap [®]	51
Multi-Paired, Overall Foil & TC Braid Shield, Lo-Cap	52
Multi-Paired, Individually Shielded (UL)	53
Multi-Paired, Individually Shielded (CSA).....	54
Multi-Paired, Individually Shielded (UL/CSA).....	55
Multi-Paired, Individually Foil Shielded	56-59
Power-Limited Tray Cable, Individually Shielded	60
Power-Limited Tray Cable, Foil Shield	61
3 Computer Cable	62-76
Multi-Conductor, Foil Shield.....	63-64
Multi-Conductor, Foil/Braid Shield	65-66
Multi-Conductor, Foil/Braid Shield, Lo-Cap.....	67
Multi-Paired, Foil Shield	68
Multi-Paired, Foil Shield, Lo-Cap	69
Multi-Paired, Foil/Braid Shield.....	70
Multi-Paired, Foil/Braid Shield, Lo-Cap	71-73
Multi-Paired, Individually Foil Shielded	74
Multi-Paired, Individually Foil Shielded, Lo-Cap	75
Multi-Paired, Individually Foil/Braid Shielded, Lo-Cap	76

Table of Contents

SECTION

PAGES

4 EXZEL® High-Endurance Cables

77-97

Carol® Brand EXZEL® For Complete Peace of Mind..... 78-80

Multi-Conductor, Unshielded	81
Multi-Conductor, Foil Shielded.....	82
Multi-Conductor, Foil/Braid Shielded	83
Multi-Paired, Unshielded	84
Multi-Paired, Foil Shielded	85
Multi-Paired, Foil/Braid Shielded	86
Multi-Conductor, Unshielded, Heavy Duty.....	87
Multi-Conductor, Foil Shielded, Heavy Duty	88
Multi-Conductor, Foil/Braid Shielded, Heavy Duty	89
Multi-Paired, Foil/Braid Shielded, Heavy Duty.....	90
LSZH Multi-Conductor, Unshielded	91
LSZH Multi-Conductor, Foil Shielded	92
LSZH Multi-Conductor, Foil/Braid Shielded.....	93
LSZH Multi-Paired, Unshielded.....	94
LSZH Multi-Paired, Foil Shielded	95
LSZH Multi-Paired, Foil/Braid Shielded	96
Color Code Charts	97

5 Fire Alarm Cables

98-111

Multi-Conductor, Unshielded, Non-Plenum	99
Multi-Conductor, Unshielded, Non-Plenum (CSA).....	100
Multi-Conductor, Shielded, Non-Plenum	101
Multi-Conductor, Shielded, Non-Plenum (CSA).....	102
Multi-Conductor, Unshielded, Plenum	103-104
Multi-Conductor, Shielded, Plenum	105-106
Mid-Capacitance, Unshielded, Non-Plenum	107
Mid-Capacitance, Shielded, Non-Plenum.....	108
Mid-Capacitance, Unshielded, Plenum.....	109
Mid-Capacitance, Shielded, Plenum.....	110
Multi-Paired, Unshielded, Non-Plenum (CSA)	111

Table of Contents

SECTION	PAGES
6 Sound, Alarm & Security Cable	112-125
Composite Access Control Cable, Plenum.....	113
Composite Access Control Cable, Riser.....	114
Multi-Conductor, Unshielded, Riser	115
Multi-Conductor, Shielded, Riser	116
Multi-Conductor, Unshielded, Plenum	117
Multi-Conductor, Shielded, Plenum	118
Telephone Station/Intercom & Speaker/Burglar Alarm	119
Low-Voltage Sprinkler Wire.....	120
Thermostat Wire Type LVT	121
Thermostat Wire Type CL2.....	122
Thermostat Wire, Unjacketed.....	123
Category 6 Cable	124
Category 5e Cable	125
7 Coaxial Cable	126-155
DBRF Coaxial	127-131
RG 6/U Type	132-137
RG 8/U Type	138-139
RG 11/U Type	140-143
RG 58/U Type	144
RG 59/U Type	145-151
RG 62/U Type	152
RG 174/U Type	153
RG 213/U Type	154
Twinaxial Cables.....	155
8 Commercial Audio/Video & Home Entertainment Cable	156-165
GEPCO® Brand Commercial A/V Solutions	157-161
Speaker Wire	162
Special Audio, Communication & Instrumentation	163-164
Microphone Cable, Multi-Conductor, Carolprene®	165

Table of Contents

SECTION

PAGES

9 Hook-Up Wire

166-172

UL 1007, UL 1569, CSA TR-64..... 167
UL 1015, CSA TEW 168
MIL-W-76B 169
UL Types MTW, TFF, AWM & CSA TEW 170
Heavy Wall UL Types MTW, AWM, NEC Type THW and CSA TEW 171
Rubber/PVC/Polyethylene..... 172

10 Technical Information

173-212

Insulation & Jacket Properties..... 174
Decimal Conversion Factors 175
Unit Conversion Factors..... 176
Temperature Conversion Chart 177
Conduit Capacity Chart..... 178
AWG Conductor Chart 179
Glossary..... 180-190
Abbreviations & Acronyms 191-193
Product Finder—Hook-Up Wire 194
Product Finder—Multi-Conductor Cable 195-197
Product Finder—Multi-Paired Cable 198-200
NEC/CEC Substitution Chart 201-202
Agency Symbols..... 203
Put-Ups and Color Codes..... 204
Catalog Number Index 205-212

One Company Connecting The World

POWERFUL PRESENCE · PRODUCTS PERFORMANCE · PEOPLE

General Cable has been a wire and cable innovator for over 170 years, always dedicated to connecting and powering people's lives. We are one of the largest wire and cable manufacturers in the world.

Our company serves customers through a network of manufacturing facilities in our core markets and has worldwide sales representation and distribution. We are dedicated to the production of high-quality aluminum, copper and fiber optic wire and cable and systems solutions for the energy, construction, industrial, specialty and communications sectors. With a vast portfolio of products to meet thousands of diverse application requirements, we continue to invest in research and development in order to maintain and extend our technology leadership by developing new materials, designing new products, and creating new solutions to meet tomorrow's market challenges.

In addition to our strong brand recognition and strengths in technology and manufacturing, General Cable is also competitive in such areas as distribution and logistics, marketing, sales and customer service. This combination enables us to better serve our customers globally and as they expand into new geographic markets.

General Cable offers our customers all the strengths and value of a large company, but our people give us the agility and responsiveness of a small one. We service you globally and locally.



Visit our Website at
www.generalcable.com



Corporate Social Responsibility

CREATING SHARED VALUE

General Cable believes corporate social responsibility (CSR) is about creating shared value. That means keeping a dual focus in our business decisions: what is good for us as a company and what contributes to the greater good of the communities in which we live and work.



SAFETY

Working safer by working together

General Cable has one worldwide safety vision and goal – **ZERO & BEYOND**. We measure safety performance globally, share best practices and implement sound health and safety management systems. Many of our facilities worldwide are OHSAS 18001 (safety management system) certified. All North American facilities have implemented an equivalent health and safety management system. General Cable was a pioneer in obtaining the OHSAS 18001 Certificate for Occupational Health and Safety Management Systems in Europe and North Africa.



SUSTAINABILITY

Responsible practices in daily operations

As a global leader in the wire and cable industry, General Cable recognizes its role and responsibility in promoting sustainability. Our strongest business value is continuous improvement in all areas of our company. Across our many businesses, the quest to introduce new and better products through continuous improvement in environmental designs reflects our commitment to achieving industry-leading standards and responding proactively to global environmental issues. General Cable was the first cable manufacturer to obtain certification for its environmental management system, in accordance with the ISO 14001 and EMAS Standards.



CITIZENSHIP

A commitment to being good citizens

Being responsible citizens in our communities is of the utmost importance to us. Unequivocal honesty, integrity, forthrightness and fair dealing have long been part of General Cable's core values and are expected globally in all of our business relationships with our customers, employees, suppliers, neighbors and competitors. Our company leaders and employees strive to make a difference throughout a host of volunteer activities and financial support, improving the communities in which we live and work.



INNOVATION

Technologies that power and connect the world

General Cable is delivering innovation that matters. We are focusing on R&D expertise and investing in developing wire and cable solutions that meet the challenges confronting our customers and the world. In working together and using all the ingenuity and creativity we have, we will reach the goal of being the preeminent supplier of wire and cabling solutions in the industry, with both green constructions and designs for the ever-growing renewable energy market.



A commitment to achieving industry-leading standards and responding proactively to environmental global issues.

+1.859.572.8000
info@generalcable.com

Visit www.GeneralCableCSR.com
to learn more.



Communication & Control Cable, Multi-Conductor

1

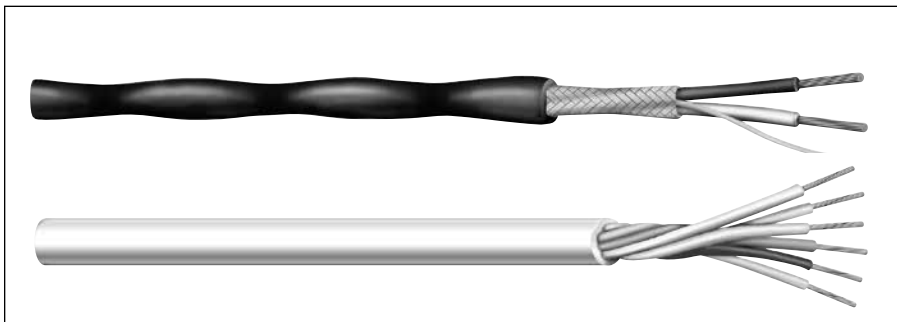

The multi-conductor array of communication and control cable facilitates cable pull-ins and single-site installations.

This cable is typically used for industrial equipment control, electric valve actuation and remote signaling, as well as communications and broadcast applications. These designs are available in a wide variety of insulation and jacketing materials, as well as shield designs to alleviate unwanted circuit noise.

General Cable's Carol® Brand products are manufactured to meet the latest UL, CSA and NEC requirements and approvals.

A Design To Meet Every Application

PVC/PVC designs employ polyvinyl chloride insulations and jackets capable of meeting everyday, general purpose applications.

PE or PP/PVC designs employ high quality polyethylene or polypropylene insulations to assure faithful reproduction of transmitted signals across interconnection circuits.

Foamed PP/PVC designs use high speed, foamed polypropylene insulations for long-distance critical circuits, which would not perform if higher loss insulations were employed.

FEP/FEP designs employ fluoropolymer 200°C-rated materials. They are recommended for use in applications where high temperature, plenum rating, electrical and mechanical safety and chemical resistance are essential.

Rubber/Rubber is typically employed in installations characterized as severely hostile environments, where these designs provide unsurpassed service life.

Rubber/Carolprene® offers the ultimate performance for applications that demand the greatest protection from the environment, including physical abuse. The specially formulated Carolprene® jacket has been proven time and again to withstand all types of abuse, both mechanical and chemical.

Index	Page
Multi-Conductor, Unshielded	2-14
Power-Limited Tray Cable, Unshielded	15
Multi-Conductor, Foil Shield	16-21
Multi-Conductor, Foil Shield (CSA)	22-25
Power-Limited Tray Cable, Foil Shield	26
Multi-Conductor, Spiral Shield	27
Multi-Conductor, Braid Shield	28-31
Multi-Conductor, Foil/Braid Shield	32
Multi-Conductor, Foil & TC Braid Shield	33
Multi-Conductor, Rubber, Unshielded	34
Multi-Conductor, Rubber, Braid Shield	35
Multi-Conductor, Carolprene, Braid Shield	36

Multi-Conductor, Unshielded

UL 2464, NEC/CEC Type CMG UL/CSA**



CATALOG NUMBER	NO. OF COND.	AWG SIZE	COND. STRAND	NOM. INSULATION THICKNESS		NOM. JACKET THICKNESS		NOMINAL O.D.		COLOR CODE	NOM. C-C CAP.* pF/ft
				INCHES	mm	INCHES	mm	INCHES	mm		
C4311A	2	20	Solid	0.010	0.25	0.032	0.81	0.166	4.22	Black/Red	28.0
C2754A	2	19	Solid	0.010	0.25	0.032	0.81	0.176	4.47	Brown/Tan	29.5

*Capacitance between conductors
 **CSA or c(UL)
 Data subject to change.

Product Construction:

Conductor:

- Fully annealed tinned copper per ASTM B33 (C4311A)
- Fully annealed solid bare copper per ASTM B3 (C2754A)

Insulation:

- Premium-grade, color-coded S-R PVC per UL AWM Style 1061

Jacket:

- PVC, gray
- Temperature range: -20°C to +80°C

Applications:

- Public address systems
- Intercoms
- Remote control circuits
- Suggested voltage rating: 300 volts

Compliances:

- NEC Article 800 Type CM (UL: 75°C)
- UL Style 2464 (UL: 80°C, 300 V)
- CSA CMG (CSA: 60°C)
- RoHS Compliant Directive 2011/65/EU
- Designed to meet UL 70,000 BTU Vertical Tray Flame Test
- Passes CSA CMG Flame Test
- CE: Low Voltage Directive (LVD) 2006/95/EC

Packaging:

- Please contact Customer Service for packaging and color options



Multi-Conductor, Unshielded

UL 2464, NEC/CEC Type CMG UL/CSA**

Product Construction:

Conductor:

- 22 thru 18 fully annealed stranded tinned copper per ASTM B33

Insulation:

- Premium-grade, color-coded PVC (18 AWG), S-R PVC (22 AWG)
- Color code: See chart below

Jacket:

- PVC, gray
- Temperature range: -20°C to +80°C

Applications:

- TV antenna rotor control
- Satellite actuator control
- Public address systems
- Suggested voltage rating: 300 volts

Compliances:

- NEC Article 800 Type CM (UL: 75°C)
- UL Style 2464 (UL: 80°C, 300 V)
- CSA CMG (CSA: 60°C)
- RoHS Compliant Directive 2011/65/EU
- Designed to meet UL 70,000 BTU Vertical Tray Flame Test
- Passes CSA CMG Flame Test
- CE: Low Voltage Directive (LVD) 2006/95/EC

Packaging:

- Please contact Customer Service for packaging and color options

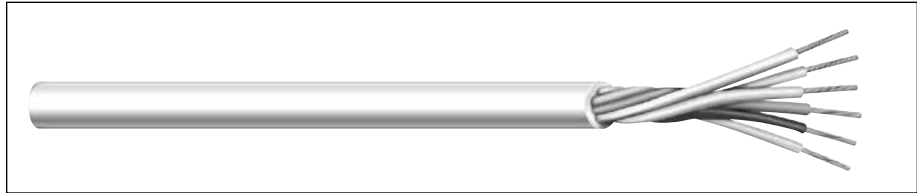

CATALOG NUMBER	NO. OF COND.	AWG SIZE	COND. STRAND	NOM. INSULATION THICKNESS		NOM. JACKET THICKNESS		NOMINAL O.D.		NOM. C-C CAP.* pF/ft
				INCHES	mm	INCHES	mm	INCHES	mm	
C4081A	6	4-22 2-18	7/30 16/30	0.010 0.016	0.25 0.41	0.032	0.81	0.244	6.20	24.5 31.0
C4082A	7	5-22 2-18	7/30 16/30	0.010 0.016	0.25 0.41	0.032	0.81	0.253	6.43	24.5 31.0
C4083A	8	6-22 2-18	7/30 16/30	0.010 0.016	0.25 0.41	0.032	0.81	0.263	6.69	24.5 31.0
C4084A	9	7-22 2-18	7/30 16/30	0.010 0.016	0.25 0.41	0.032	0.81	0.273	6.94	24.5 31.0

*Capacitance between conductors

**CSA or c(UL)

Data subject to change.

Color Code Chart

NO. OF COND.	COLOR
1 18 ga.	Black
2	White
1 22 ga.	Red
2	Green
3	Brown
4	Blue
5	Orange
6	Yellow
7	Purple

Multi-Conductor, Unshielded

UL 2464, UL 2576, NEC/CEC Type CMG UL/CSA**

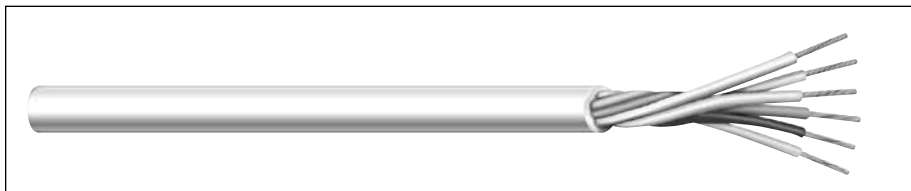

CATALOG NUMBER	NO. OF COND.	AWG SIZE	COND. STRAND	NOM. INSULATION THICKNESS		NOM. JACKET THICKNESS		NOMINAL O.D.		COLOR CODE	NOM. C-C CAP.* pF/ft
				INCHES	mm	INCHES	mm	INCHES	mm		
C2461A	2	24	7/32	0.010	0.25	0.032	0.81	0.152	3.86	Black/Red	23.0
C2462A	3	24	7/32	0.010	0.25	0.032	0.81	0.163	4.14	Black/Red/Green	23.0
C2463A	4	24	7/32	0.010	0.25	0.032	0.81	0.174	4.42	1	23.0
C2464A	5	24	7/32	0.010	0.25	0.032	0.81	0.183	4.75	1	23.0
C2466A	6	24	7/32	0.010	0.25	0.032	0.81	0.200	5.08	1	23.0
C2488A	7	24	7/32	0.010	0.25	0.032	0.81	0.200	5.08	1	23.0
C2465A	8	24	7/32	0.010	0.25	0.032	0.81	0.214	5.44	1	23.0
C2470A	9	24	7/32	0.010	0.25	0.032	0.81	0.227	5.77	1	23.0
C2471A	10	24	7/32	0.010	0.25	0.032	0.81	0.244	6.20	1	23.0
C2467A	12	24	7/32	0.010	0.25	0.032	0.81	0.251	6.38	1	23.0
C2473A	15	24	7/32	0.010	0.25	0.032	0.81	0.275	6.99	2	23.0

*Capacitance between conductors

**CSA or c(UL)

Data subject to change.

Product Construction:

Conductor:

- 24 AWG fully annealed stranded tinned copper per ASTM B33

Insulation:

- Premium-grade, color-coded S-R PVC per UL AWM Style 1061
- Color code: See charts below

Jacket:

- PVC, gray
- Temperature range: -20°C to +80°C

Applications:

- Public address systems
- Intercoms
- Internal telephones
- Remote control circuits
- Suitable for EIA RS-232 applications
- Suggested voltage rating: 300 volts

Compliances:

- NEC Article 800 Type CM (UL: 75°C)
- UL Style 2464 (UL: 80°C, 300 V)
- UL Style 2576 (UL: 80°C, 150 V)
- CSA CMG (CSA: 60°C)
- RoHS Compliant Directive 2011/65/EU
- Designed to meet UL 70,000 BTU Vertical Tray Flame Test
- Passes CSA CMG Flame Test
- CE: Low Voltage Directive (LVD) 2006/95/EC

Packaging:

- Please contact Customer Service for packaging and color options

Color Code Chart 1 - For cables up to and including 12 conductors

NO. OF COND.	COLOR	NO. OF COND.	COLOR
1	Black	7	Orange
2	White	8	Yellow
3	Red	9	Purple
4	Green	10	Gray
5	Brown	11	Pink
6	Blue	12	Tan

Color Code Chart 2 Per ICEA - For cables with 15 conductors

NO. OF COND.	COLOR	NO. OF COND.	COLOR	NO. OF COND.	COLOR
1	Black	6	Blue	11	Blue/Black
2	White	7	White/Black	12	Black/White
3	Red	8	Red/Black	13	Red/White
4	Green	9	Green/Black	14	Green/White
5	Orange	10	Orange/Black	15	Blue/White



Multi-Conductor, Unshielded

UL 2464, UL 2576, NEC/CEC Type CMG UL/CSA**

Product Construction:

Conductor:

- 22 AWG fully annealed, stranded tinned copper per ASTM B33

Insulation:

- Premium-grade, color-coded S-R PVC per UL AWM Style 1061
- Color code: See charts below

Jacket:

- PVC, gray
- Temperature range: -20°C to +80°C

Applications:

- Public address systems
- Intercoms
- Internal telephones
- Remote control circuits
- Suitable for EIA RS-232 applications
- Suggested voltage rating: 300 volts

Compliances:

- NEC Article 800 Type CM (UL: 75°C)
- UL Style 2464 (UL: 80°C, 300 V)
- UL Style 2576 (UL: 80°C, 150 V)
- CSA CMG (CSA 60°C)
- RoHS Compliant Directive 2011/65/EU
- Designed to meet UL 70,000 BTU Vertical Tray Flame Test
- Passes CSA CMG Flame Test
- CE: Low Voltage Directive (LVD) 2006/95/EC

Packaging:

- Please contact Customer Service for packaging and color options

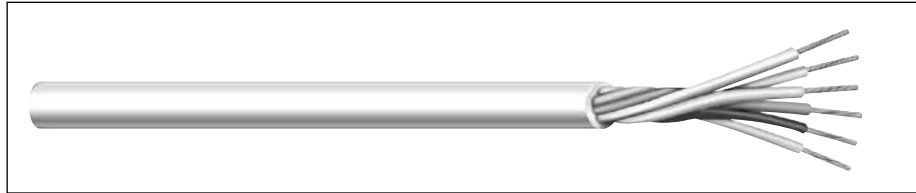

CATALOG NUMBER	NO. OF COND.	AWG SIZE	COND. STRAND	NOM. INSULATION THICKNESS		NOM. JACKET THICKNESS		NOMINAL O.D.		COLOR CODE	NOM. C-C CAP* pF/ft
				INCHES	mm	INCHES	mm	INCHES	mm		
C6348A†	2	22	7/30	0.010	0.25	0.015	0.38	0.130	3.30	Black/Red	24.5
C4062A	3	22	7/30	0.010	0.25	0.032	0.81	0.176	4.47	Black/Red/Green	24.5
C4063A	4	22	7/30	0.010	0.25	0.032	0.81	0.189	4.80	1	24.5
C4064A	5	22	7/30	0.010	0.25	0.032	0.81	0.203	5.16	1	24.5
C4066A	6	22	7/30	0.010	0.25	0.032	0.81	0.218	5.54	1	24.5
C4088A	7	22	7/30	0.010	0.25	0.032	0.81	0.205	5.54	1	24.5
C4065A	8	22	7/30	0.010	0.25	0.032	0.81	0.230	5.94	1	24.5
C4070A	9	22	7/30	0.010	0.25	0.032	0.81	0.249	6.32	1	24.5
C4071A	10	22	7/30	0.010	0.25	0.032	0.81	0.268	6.81	1	24.5
C4067A	12	22	7/30	0.010	0.25	0.032	0.81	0.276	7.01	1	24.5
C4073A	15	22	7/30	0.010	0.25	0.032	0.81	0.303	7.70	2	24.5
C4075A	20	22	7/30	0.010	0.25	0.032	0.81	0.334	8.48	2	24.5
C4076A	25	22	7/30	0.010	0.25	0.032	0.81	0.368	9.35	2	24.5
C4077A	30	22	7/30	0.010	0.25	0.032	0.81	0.389	9.88	2	24.5
C4078A	40	22	7/30	0.010	0.25	0.032	0.81	0.434	11.02	2	24.5
C4079A	50	22	7/30	0.010	0.25	0.032	0.81	0.489	12.42	2	24.5

*Capacitance between conductors

**CSA or c(UL)

†CM-CSA CMG Only

Data subject to change.

Color Code Chart 1 - For cables up to and including 12 conductors

NO. OF COND.	COLOR	NO. OF COND.	COLOR
1	Black	7	Orange
2	White	8	Yellow
3	Red	9	Purple
4	Green	10	Gray
5	Brown	11	Pink
6	Blue	12	Tan

Color Code Chart 2 Per ICEA - For cables of 15 thru 50 conductors

NO. OF COND.	COLOR	NO. OF COND.	COLOR	NO. OF COND.	COLOR	NO. OF COND.	COLOR
1	Black	14	Green/White	27	Blue/Black/White	39	White/Black/Green
2	White	15	Blue/White	28	Black/Red/Green	40	Red/White/Green
3	Red	16	Black/Red	29	White/Red/Green	41	Green/White/Blue
4	Green	17	White/Red	30	Red/Black/Green	42	Orange/Red/Green
5	Orange	18	Orange/Red	31	Green/Black/Orange	43	Blue/Red/Green
6	Blue	19	Blue/Red	32	Orange/Black/Green	44	Black/White/Blue
7	White/Black	20	Red/Green	33	Blue/White/Orange	45	White/Black/Blue
8	Red/Black	21	Orange/Green	34	Black/White/Orange	46	Red/White/Blue
9	Green/Black	22	Black/White/Red	35	White/Red/Orange	47	Green/Orange/Red
10	Orange/Black	23	White/Black/Red	36	Orange/White/Blue	48	Orange/Red/Blue
11	Blue/Black	24	Red/Black/White	37	White/Red/Blue	49	Blue/Red/Orange
12	Black/White	25	Green/Black/White	38	Black/White/Green	50	Black/Orange/Red
13	Red/White	26	Orange/Black/White				



Multi-Conductor, Unshielded

UL 2464, UL 2576, NEC/CEC Type CMG UL/CSA**

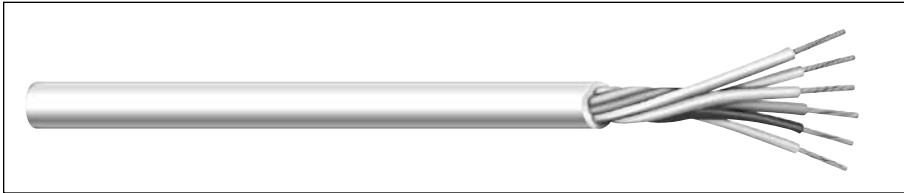

Product Construction:

Conductor:

- 20 or 18 AWG fully annealed stranded, tinned copper per ASTM B33

Insulation:

- Premium-grade, color-coded PVC per UL AWM Style 1007
- Color code: See charts below

Jacket:

- PVC, gray
- Temperature range: -20°C to +80°C

Applications:

- Public address systems
- Intercoms
- Internal telephones
- Remote control circuits
- Suitable for EIA RS-232 applications
- Suggested voltage rating: 300 volts

Compliances:

- NEC Article 800 Type CM (UL: 75°C)
- UL Style 2464 (UL: 80°C, 300 V)
- UL Style 2576 (UL: 80°C, 150 V)
- CSA CMG (CSA: 60°C)
- RoHS Compliant Directive 2011/65/EU
- Designed to meet UL 70,000 BTU Vertical Tray Flame Test
- Passes CSA CMG Flame Test
- CE: Low Voltage Directive (LVD) 2006/95/EC

Packaging:

- Please contact Customer Service for packaging and color options

CATALOG NUMBER	NO. OF COND.	AWG SIZE	COND. STRAND	NOM. INSULATION THICKNESS		NOM. JACKET THICKNESS		NOMINAL O.D.		COLOR CODE	NOM. C-C CAP.* pF/ft
				INCHES	mm	INCHES	mm	INCHES	mm		
C6351A†	2	20	7/28	0.016	0.41	0.025	0.64	0.192	4.88	Black/Red	28.0
C6352A	3	20	7/28	0.016	0.41	0.032	0.81	0.216	5.50	1	28.0
C6353A	4	20	7/28	0.016	0.41	0.032	0.81	0.235	5.97	1	28.0
C6355A	5	20	7/28	0.016	0.41	0.032	0.81	0.254	6.46	1	28.0
C6356A	7	20	7/28	0.016	0.41	0.032	0.81	0.275	6.99	1	28.0
C6357A	9	20	7/28	0.016	0.41	0.032	0.81	0.317	8.05	1	28.0
C6360A	12	20	7/28	0.016	0.41	0.032	0.81	0.354	9.00	2	28.0
C6358A	15	20	7/28	0.016	0.41	0.032	0.81	0.392	9.96	2	28.0
C2830A†	2	18	16/30	0.016	0.41	0.015	0.64	0.190	5.33	Black/Red	30.5
C2831A	3	18	16/30	0.016	0.41	0.032	0.81	0.236	5.99	1	30.5
C2404A	4	18	16/30	0.016	0.41	0.032	0.81	0.258	6.55	1	30.5
C2420A	5	18	16/30	0.016	0.41	0.032	0.81	0.280	7.11	1	30.5
C2421A	7	18	16/30	0.016	0.41	0.032	0.81	0.309	7.85	1	30.5
C2422A	9	18	16/30	0.016	0.41	0.032	0.81	0.358	9.09	1	30.5
C2412A	12	18	16/30	0.016	0.41	0.032	0.81	0.401	10.19	2	30.5
C2423A	15	18	16/30	0.016	0.41	0.032	0.81	0.445	11.30	2	30.5
C2424A	19	18	16/30	0.016	0.41	0.032	0.81	0.469	11.91	2	30.5
C2433A	25	18	16/30	0.016	0.41	0.032	0.81	0.550	13.94	2	30.5

*Capacitance between conductors

**CSA or c(UL)

†CM (UL) c(UL), CSA CMG Only

Data subject to change.

Color Code Chart 1 - For cables up to and including 9 conductors

NO. OF COND.	COLOR	NO. OF COND.	COLOR
1	Black	6	Blue
2	White	7	Orange
3	Red	8	Yellow
4	Green	9	Purple
5	Brown		

Color Code Chart 2 Per ICEA - For cables of 12 thru 25 conductors

NO. OF COND.	COLOR	NO. OF COND.	COLOR	NO. OF COND.	COLOR
1	Black	10	Orange/Black	19	Blue/Red
2	White	11	Blue/Black	20	Red/Green
3	Red	12	Black/White	21	Orange/Green
4	Green	13	Red/White	22	Black/White/Red
5	Orange	14	Green/White	23	White/Black/Red
6	Blue	15	Blue/White	24	Red/Black/White
7	White/Black	16	Black/Red	25	Green/Black/White
8	Red/Black	17	White/Red		
9	Green/Black	18	Orange/Red		



Multi-Conductor, Unshielded

UL 2464, UL 2587, NEC Type CM3, NEC/CEC Type CMG UL/CSA**

Product Construction:

Conductor:

- 16 thru 12 AWG fully annealed stranded tinned copper per ASTM B33

Insulation:

- Premium-grade, color-coded PVC
- Color code: See chart below

Jacket:

- PVC, gray
- Temperature range: -20°C to +90°C

Applications:

- Public address systems
- Intercoms
- Internal telephones
- Remote control circuits
- Suitable for EIA RS-232 applications
- Suggested voltage rating: 300 volts

Compliances:

- NEC Article 725 Type CL3 (UL: 75°C)
- NEC Article 800 Type CM (UL: 75°C)
- UL Style 2464 (UL: 80°C, 300 V)
- UL Style 2587 (UL: 90°C, 600 V)
- CSA CMG (CSA: 60°C)
- RoHS Compliant Directive 2011/65/EU
- Designed to meet UL 70,000 BTU Vertical Tray Flame Test
- Passes CSA CMG Flame Test
- CE: Low Voltage Directive (LVD) 2006/95/EC

Packaging:

- Please contact Customer Service for packaging and color options

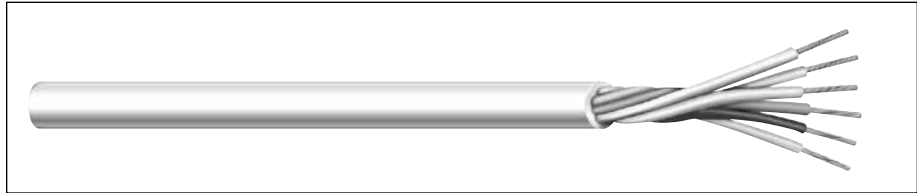

CATALOG NUMBER	NO. OF COND.	AWG SIZE	COND. STRAND	NOM. INSULATION THICKNESS		NOM. JACKET THICKNESS		NOMINAL O.D.		NOM. C-C CAP.* pF/ft
				INCHES	mm	INCHES	mm	INCHES	mm	

NEC TYPE CM, UL STYLE 2464 (80°C, 300 VOLTS)

C2405A	2	16	19/.0117	0.021	0.53	0.032	0.81	0.260	6.81	30.5
C2406A	3	16	19/.0117	0.021	0.53	0.032	0.81	0.283	7.19	30.5
C2425A	4	16	19/.0117	0.021	0.53	0.032	0.81	0.306	7.77	30.5
C2434A	5	16	19/.0117	0.021	0.53	0.032	0.81	0.334	8.48	30.5
C2426A	7	16	19/.0117	0.021	0.53	0.032	0.81	0.363	9.25	30.5
C2443A	8	16	19/.0117	0.021	0.53	0.032	0.81	0.393	10.03	30.5
C2435A	9	16	19/.0117	0.021	0.53	0.032	0.81	0.423	10.80	30.5
C2427A	12	16	19/.0117	0.021	0.53	0.032	0.81	0.476	12.17	30.5
C2428A	15	16	19/.0117	0.021	0.53	0.032	0.81	0.530	13.46	30.5
C2429A	19	16	19/.0117	0.021	0.53	0.032	0.81	0.559	14.33	30.5
C2436A	25	16	19/.0117	0.021	0.53	0.032	0.81	0.657	16.69	30.5

NEC TYPE CL3, UL STYLE 2587 (90°C, 600 VOLTS)

C2409A	2	14	19/.0147	0.032	0.81	0.032	0.81	0.326	8.51	29.0
C2430A	4	14	19/.0147	0.032	0.81	0.032	0.81	0.391	9.93	28.2
C2437A	5	14	19/.0147	0.032	0.81	0.032	0.81	0.428	10.87	28.2
C2431A	7	14	19/.0147	0.032	0.81	0.032	0.81	0.469	11.91	28.2
C2410A	2	12	19/0.0185	0.032	0.81	0.032	0.81	0.366	9.40	31.0
C2440A	4	12	19/0.0185	0.032	0.81	0.032	0.81	0.437	11.02	31.0

*Capacitance between conductors

**CSA or c(UL)

Data subject to change.

Color Code Chart Per ICEA

NO. OF COND.	COLOR	NO. OF COND.	COLOR	NO. OF COND.	COLOR
1	Black	10	Orange/Black	19	Blue/Red
2	White	11	Blue/Black	20	Red/Green
3	Red	12	Black/White	21	Orange/Green
4	Green	13	Red/White	22	Black/White/Red
5	Orange	14	Green/White	23	White/Black/Red
6	Blue	15	Blue/White	24	Red/Black/White
7	White/Black	16	Black/Red	25	Green/Black/White
8	Red/Black	17	White/Red		
9	Green/Black	18	Orange/Red		

Multi-Conductor, Unshielded

NEC Type CMP (UL) c(UL)

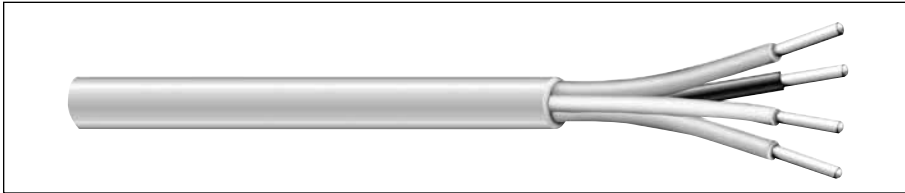

CATALOG NUMBER	NO. OF COND.	AWG SIZE	COND. STRAND	NOM. INSULATION THICKNESS		NOM. JACKET THICKNESS		NOMINAL O.D.		NOM. C-C CAP.* pF/ft
				INCHES	mm	INCHES	mm	INCHES	mm	
C8102	4	18	19/30	0.007	0.18	0.014	0.36	0.178	4.52	21.5

*Capacitance between conductors
Data subject to change.

Color Code Chart

NO. OF COND.	COLOR
1	Black
2	White
3	Red
4	Green

Product Construction:

Conductor:

- 18 AWG fully annealed stranded tinned copper per ASTM B33

Insulation:

- Premium-grade, color-coded FEP
- Color code: See chart below

Jacket:

- Flexguard® PVC, natural
- Temperature range: -20°C to +75°C

Applications:

- Audio systems
- Remote control circuits
- Process control and instrumentation
- Suggested voltage rating: 300 volts

Compliances:

- NEC Article 800 (UL: 75°C, 300 V)
- Designed to meet NFPA 262 and CSA FT6 Steiner Tunnel Fire Tests for Plenum Applications
- CE: Low Voltage Directive (LVD) 2006/95/EC

Packaging:

- Please contact Customer Service for packaging and color options



Designed to Meet
NFPA 262 and CSA FT6
Steiner Tunnel Fire Tests
for Plenum Applications

Underwriters Laboratories Inc.



Multi-Conductor, Unshielded

NEC Type CMP (UL) c(UL) and/or CL2P

Product Construction:

Conductor:

- 22 thru 14 AWG fully annealed stranded tinned or bare copper per ASTM B3, B8 or B33

Insulation:

- Premium-grade, color-coded Flexguard® PVC
- Color code: See chart below

Jacket:

- Fluoropolymer, natural
- Temperature range: -20°C to +75°C
- Sequential footage marked to facilitate installation
- Abrasion-, chemical- and water-resistant
- Includes ripcord

Applications:

- Intercom systems
- Background music
- Audio systems
- Power-limited control circuits
- Suggested voltage rating: 150 volts

Compliances:

- NEC Article 725 (UL: 75°C, 150 V)
- NEC Article 800 (UL: 75°C, 300 V)
- Designed to meet NFPA 262 and CSA FT6 Steiner Tunnel Fire Tests for Plenum Applications
- CE: Low Voltage Directive (LVD) 2006/95/EC

Packaging:

- Please contact Customer Service for packaging and color options

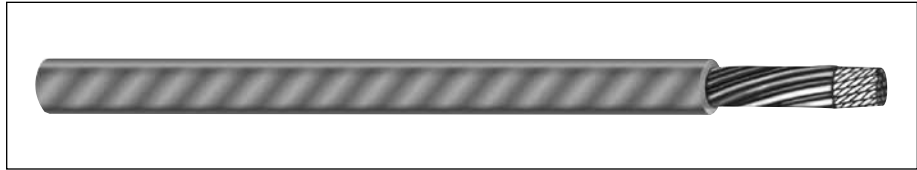

CATALOG NUMBER	NO. OF COND.	AWG SIZE	COND. STRAND	NOM. INSULATION THICKNESS		NOM. JACKET THICKNESS		NOMINAL O.D.		NOM. C-C CAP.* pF/ft
				INCHES	mm	INCHES	mm	INCHES	mm	
C3105†	2	22	7/30 TC	0.006	0.15	0.010	0.25	0.089	2.26	29.0
C3106†	4	22	7/30 TC	0.006	0.15	0.010	0.25	0.121	3.07	29.0
C3102	2	18	7/26 BC	0.008	0.20	0.010	0.25	0.123	3.12	31.0
C3190	3	18	7/26 BC	0.008	0.20	0.010	0.25	0.143	3.63	31.0
C3103	4	18	7/26 BC	0.008	0.20	0.010	0.25	0.163	4.14	31.0
C3134	5	18	7/26 BC	0.008	0.20	0.010	0.25	0.187	4.75	30.8
C3192	6	18	7/26 BC	0.008	0.20	0.010	0.25	0.198	5.03	31.0
C3191	8	18	7/26 BC	0.008	0.20	0.010	0.25	0.223	5.66	31.0
C3178	10	18	7/26 BC	0.008	0.20	0.010	0.25	0.244	6.19	31.0
C3179	12	18	7/26 BC	0.008	0.20	0.010	0.25	0.263	6.68	31.0
C3193	2	16	19/.0117 BC	0.008	0.20	0.010	0.25	0.141	3.58	33.0
C3194	3	16	7/.0192 BC	0.008	0.20	0.010	0.25	0.164	4.17	33.0
C3195	4	16	7/.0192 BC	0.008	0.20	0.010	0.25	0.187	4.75	33.0
C3126†	2	14	19/.0147 BC	0.010	0.25	0.010	0.25	0.168	4.27	35.0
C3135†	2	12	19/.0185 BC	0.010	0.25	0.010	0.25	0.238	6.05	37.0

*Capacitance between conductors

†CL2P only

Data subject to change.

Color Code Chart

NO. OF COND.	COLOR
1	Black
2	White
3	Red
4	Green
5	Brown
6	Blue
7	Orange
8	Yellow
9	Purple
10	Gray
11	Pink
12	Tan

Multi-Conductor, Unshielded

NEC Type CMP (UL) c(UL) and/or CL3P

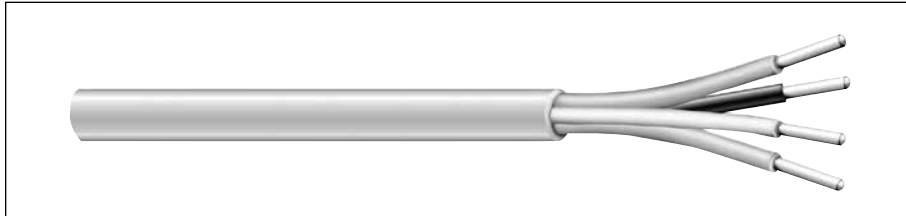

Product Construction:

Conductor:

- 22 thru 12 AWG fully annealed solid, stranded tinned or bare copper per ASTM B3, B8 or B33

Insulation:

- Premium-grade, color-coded Flexguard® PVC
- Color code: See chart below

Jacket:

- Flexguard® PVC, natural
- Temperature range: 0°C to +75°C
- Sequential footage marked to facilitate installation
- Includes ripcord

Applications:

- Intercom systems
- Background music
- Audio systems
- Power-limited control circuits
- Suggested voltage rating: 150 volts

Compliances:

- NEC Article 725 (UL: 75°C, 150 V)
- NEC Article 800 (UL: 75°C, 300 V)
- RoHS Compliant Directive 2011/65/EU
- Designed to meet NFPA 262 and CSA FT6 Steiner Tunnel Fire Tests for Plenum Applications
- CE: Low Voltage Directive (LVD) 2006/95/EC

Packaging:

- Please contact Customer Service for packaging and color options

CATALOG NUMBER	NO. OF COND.	AWG SIZE	COND. STRAND	NOM. INSULATION THICKNESS		NOM. JACKET THICKNESS		NOMINAL O.D.		NOM.* C-C GAP. pF/ft
				INCHES	mm	INCHES	mm	INCHES	mm	

22 AWG CONDUCTORS

C3115	2	22	7/32 TC	0.008	0.20	0.015	0.38	0.122	3.10	30.0
C3116	4	22	7/32 TC	0.008	0.20	0.015	0.38	0.141	3.58	30.0

18 AWG CONDUCTORS

C3110	2	18	Solid BC	0.008	0.20	0.015	0.38	0.142	3.61	37.0
C3114	3	18	Solid BC	0.008	0.20	0.015	0.38	0.151	3.84	37.0
C3111	4	18	Solid BC	0.008	0.20	0.015	0.38	0.166	4.22	37.0
C3117	5	18	Solid BC	0.008	0.20	0.015	0.38	0.182	4.62	37.0
C3118	6	18	Solid BC	0.008	0.20	0.015	0.38	0.199	5.05	37.0
C3119	8	18	Solid BC	0.008	0.20	0.015	0.38	0.216	5.49	37.0
C3112	2	18	7/26 BC	0.008	0.20	0.015	0.38	0.156	3.96	35.0
C3120	3	18	7/26 BC	0.008	0.20	0.015	0.38	0.166	4.22	35.0
C3113	4	18	7/26 BC	0.008	0.20	0.015	0.38	0.182	4.62	35.0
C3125	5	18	7/26 BC	0.008	0.20	0.015	0.38	0.200	5.08	54.6
C3121	6	18	7/26 BC	0.008	0.20	0.015	0.38	0.216	5.49	35.0
C3122	8	18	7/26 BC	0.008	0.20	0.015	0.38	0.239	6.07	35.0
C3123	10	18	7/26 BC	0.008	0.20	0.015	0.38	0.278	7.06	35.0
C3124	12	18	7/26 BC	0.008	0.20	0.015	0.38	0.287	7.29	35.0

16 AWG CONDUCTORS

C3127	2	16	19/.0117 BC	.009	.227	0.015	0.38	0.178	4.52	40.0
-------	---	----	-------------	------	------	-------	------	-------	------	------

14 AWG CONDUCTORS

C3128†	2	14	19/.0147 BC	0.010	0.20	0.015	0.38	0.212	5.38	40.0
--------	---	----	-------------	-------	------	-------	------	-------	------	------

12 AWG CONDUCTORS

C3129†	2	12	19/.0185 BC	0.010	0.20	0.015	0.38	0.254	6.45	43.0
--------	---	----	-------------	-------	------	-------	------	-------	------	------

*Capacitance between conductors

†CL3P only

Data subject to change.

Color Code Chart

NO. OF COND.	COLOR	NO. OF COND.	COLOR
1	Black	7	Orange
2	White	8	Yellow
3	Red	9	Purple
4	Green	10	Gray
5	Brown	11	Pink
6	Blue	12	Tan



Designed to Meet
NFPA 262 and CSA FT6
Steiner Tunnel Fire Tests
for Plenum Applications

Underwriters Laboratories Inc.



Multi-Conductor, Unshielded

AWM Style 2464, CSA Type AWM I/II A/B, NEC/CEC Type CMG (CSA C/US)

Product Construction:

Conductor:

- 20 or 18 AWG fully annealed, stranded tinned copper per ASTM B33

Insulation:

- Premium-grade, color-coded PVC
- Color code: See charts below

Jacket:

- PVC, gray
- Temperature range: -20°C to +105°C

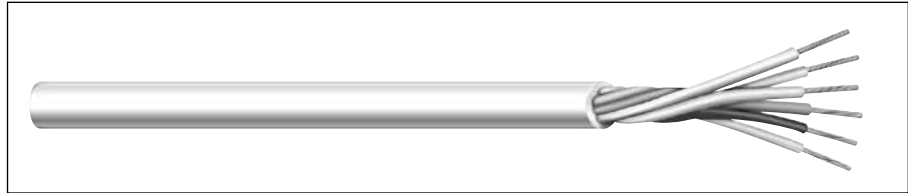

Applications:

- Public address systems
- Intercoms
- Internal telephones
- Remote control circuits
- Suitable for EIA RS-232 applications
- Suggested voltage rating: 300 or 600 volts

Compliances:

- AWM Style 2464 (UL: 80°C, 300 V)
- CSA Type AWM (105°C, 600 V)
- CSA Certified CMG to harmonized standard UL 444 and CSA 22.2 No. 214
- NEC/CEC Type CMG (CSA: 105°C, 300 V)
- RoHS Compliant Directive 2011/65/EU
- Designed to meet CSA 70,000 BTU Vertical Tray Flame Test
- Passes CSA FT4 vertical flame test
- CE: Low Voltage Directive (LVD) 2006/95/EC

Packaging:

- Please contact Customer Service for packaging and color options

CATALOG NUMBER	NO. OF COND.	AWG SIZE	COND. STRAND	NOM. INSULATION THICKNESS		NOM. JACKET THICKNESS		NOMINAL O.D.		COLOR CODE	NOM. C-C CAP.* pF/ft
				INCHES	mm	INCHES	mm	INCHES	mm		
C4117A	2	20	7/28	0.012	0.30	0.032	0.81	0.184	4.67	Black/Red	31.0
C4118A	3	20	7/28	0.012	0.30	0.032	0.81	0.193	4.90	1	31.0
C4119A	4	20	7/28	0.012	0.30	0.032	0.81	0.209	5.31	1	31.0
C4120A	5	20	7/28	0.012	0.30	0.032	0.81	0.226	5.74	1	31.0
C4121A	7	20	7/28	0.012	0.30	0.032	0.81	0.244	6.20	1	31.0
C4122A	9	20	7/28	0.012	0.30	0.032	0.81	0.281	7.14	1	31.0
C4123A	12	20	7/28	0.012	0.30	0.032	0.81	0.313	7.95	2	31.0
C4124A	15	20	7/28	0.012	0.30	0.032	0.81	0.329	8.36	2	31.0
C4125A	2	18	16/30	0.012	0.30	0.032	0.81	0.202	5.13	Black/Red	34.0
C4214A	2	18	16/30	0.012	0.30	0.032	0.81	0.202	5.13	1	34.0
C4126A	3	18	16/30	0.012	0.30	0.032	0.81	0.213	5.41	1	34.0
C4127A	4	18	16/30	0.012	0.30	0.032	0.81	0.231	5.87	1	34.0
C4128A	5	18	16/30	0.012	0.30	0.032	0.81	0.250	6.35	1	34.0
C4206A	6	18	16/30	0.012	0.30	0.032	0.81	0.266	6.76	1	34.0
C4129A	7	18	16/30	0.012	0.30	0.032	0.81	0.271	6.88	1	34.0
C4130A	9	18	16/30	0.012	0.30	0.032	0.81	0.314	7.98	1	34.0
C4131A	12	18	16/30	0.012	0.30	0.032	0.81	0.351	8.92	2	34.0
C4132A	15	18	16/30	0.012	0.30	0.032	0.81	0.388	9.86	2	34.0
C4133A	19	18	16/30	0.012	0.30	0.032	0.81	0.409	10.39	2	34.0
C4134A	25	18	16/30	0.012	0.30	0.032	0.81	0.478	12.14	2	34.0

*Capacitance between conductors
Data subject to change.

Color Code Chart 1 - For cables up to and including 9 conductors

NO. OF COND.	COLOR	NO. OF COND.	COLOR
1	Black	6	Blue
2	White	7	Orange
3	Red	8	Yellow
4	Green	9	Purple
5	Brown		

Color Code Chart 2 Per ICEA - For cables of 12 thru 25 conductors

NO. OF COND.	COLOR	NO. OF COND.	COLOR	NO. OF COND.	COLOR
1	Black	10	Orange/Black	19	Blue/Red
2	White	11	Blue/Black	20	Red/Green
3	Red	12	Black/White	21	Orange/Green
4	Green	13	Red/White	22	Black/White/Red
5	Orange	14	Green/White	23	White/Black/Red
6	Blue	15	Blue/White	24	Red/Black/White
7	White/Black	16	Black/Red	25	Green/Black/White
8	Red/Black	17	White/Red		
9	Green/Black	18	Orange/Red		

Multi-Conductor, Unshielded

AWM Styles 2464, 2587, CSA Type AWM I/II A/B, NEC/CEC Type CMG (CSA C/US), or NEC Type CL2

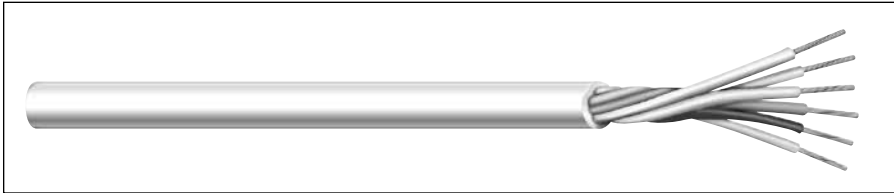

Product Construction:

Conductor:

- 16 thru 12 AWG fully annealed, stranded tinned copper per ASTM B33

Insulation:

- Premium-grade, color-coded PVC
- Color code: See chart below

Jacket:

- PVC, gray
- Temperature range: -20°C to +105°C

Applications:

- Public address systems
- Intercoms
- Internal telephones
- Remote control circuits
- Suitable for EIA RS-232 applications
- Suggested voltage rating: 300 or 600 volts

Compliances:

- AWM Style 2464 (UL: 80°C, 300 V)
- AWM Style 2587 (CSA: 90°C, 600 V)
- CSA Type AWM (105°C, 600 V)
- CSA Certified CMG to harmonized standard UL 444 and CSA 22.2 No. 214
- NEC/CEC Type CMG (CSA: 105°C, 300 V)
- RoHS Compliant Directive 2011/65/EU
- Designed to meet CSA 70,000 BTU Vertical Tray Flame Test
- Passes CSA FT4 Vertical Flame Test
- UL Certified CL2 to Standard UL 13
- Designed to meet UL 70,000 BTU Vertical Tray Flame Test
- CE: Low Voltage Directive (LVD) 2006/95/EC

Packaging:

- Please contact Customer Service for packaging and color options

CATALOG NUMBER	NO. OF COND.	AWG SIZE	COND. STRAND	NOM. INSULATION THICKNESS		NOM. JACKET THICKNESS		NOMINAL O.D.		NOM. C-C CAP.* pF/ft
				INCHES	mm	INCHES	mm	INCHES	mm	

AWM STYLE 2464, CSA TYPE AWM, CSA C/US TYPE CMG

C4135A	2	16	19/.0117	0.021	0.53	0.032	0.81	0.268	6.81	27.0
C4136A	3	16	19/.0117	0.021	0.53	0.032	0.81	0.283	7.19	27.0
C4137A	4	16	19/.0117	0.021	0.53	0.032	0.81	0.306	7.77	27.0
C4138A	5	16	19/.0117	0.021	0.53	0.032	0.81	0.334	8.48	27.0
C4139A	7	16	19/.0117	0.021	0.53	0.032	0.81	0.364	9.25	27.0
C4140A	8	16	19/.0117	0.021	0.53	0.032	0.81	0.395	10.03	27.0
C4141A	9	16	19/.0117	0.021	0.53	0.032	0.81	0.425	10.80	27.0
C4142A	12	16	19/.0117	0.021	0.53	0.032	0.81	0.479	12.17	27.0
C4143A	15	16	19/.0117	0.021	0.53	0.032	0.81	0.530	13.46	27.0
C4144A	19	16	19/.0117	0.021	0.53	0.032	0.81	0.564	14.33	27.0
C4145A	25	16	19/.0117	0.021	0.53	0.032	0.81	0.657	16.69	27.0

AWM STYLE 2587, CSA TYPE AWM (FT4), NEC TYPE CL2**

C4146A	2	14	19/.0147	0.032	0.81	0.032	0.81	0.334	8.48	25.0
C4147A	4	14	19/.0147	0.032	0.81	0.032	0.81	0.391	9.93	25.0
C4148A	5	14	19/.0147	0.032	0.81	0.032	0.81	0.428	10.87	25.0
C4149A	7	14	19/.0147	0.032	0.81	0.032	0.81	0.469	11.91	25.0
C4150A	2	12	19/.0185	0.032	0.81	0.032	0.81	0.370	9.40	29.4
C4151A	4	12	19/.0185	0.032	0.81	0.032	0.81	0.434	11.02	29.4

* Capacitance between conductors
Data subject to change.

Color Code Chart Per ICEA

NO. OF COND.	COLOR	NO. OF COND.	COLOR	NO. OF COND.	COLOR
1	Black	10	Orange/Black	19	Blue/Red
2	White	11	Blue/Black	20	Red/Green
3	Red	12	Black/White	21	Orange/Green
4	Green	13	Red/White	22	Black/White/Red
5	Orange	14	Green/White	23	White/Black/Red
6	Blue	15	Blue/White	24	Red/Black/White
7	White/Black	16	Black/Red	25	Green/Black/White
8	Red/Black	17	White/Red		
9	Green/Black	18	Orange/Red		



Multi-Conductor, Unshielded

AWM Style 2464, CSA Type AWM I/II A/B, NEC/CEC Type CMG (CSA C/US)

Product Construction:

Conductor:

- 22 AWG fully annealed, stranded tinned copper per ASTM B33

Insulation:

- Premium-grade, color-coded PVC
- Color code: See charts below

Jacket:

- PVC, gray
- Temperature range: -20°C to +105°C

Applications:

- Public address systems
- Intercoms
- Internal telephones
- Remote control circuits
- Suitable for EIA RS-232 applications
- Suggested voltage rating: 300 or 600 volts

Compliances:

- AWM Style 2464 (UL: 80°C, 300 V)
- CSA Type AWM (105°C, 600 V)
- CSA Certified CMG to harmonized standard UL 444 and CSA 22.2 No. 214
- NEC/CEC Type CMG (CSA: 105°C, 300 V)
- RoHS Compliant Directive 2011/65/EU
- Designed to meet CSA 70,000 BTU Vertical Tray Flame Test
- Passes CSA FT4 vertical flame test
- CE: Low Voltage Directive (LVD) 2006/95/EC

Packaging:

- Please contact Customer Service for packaging and color options

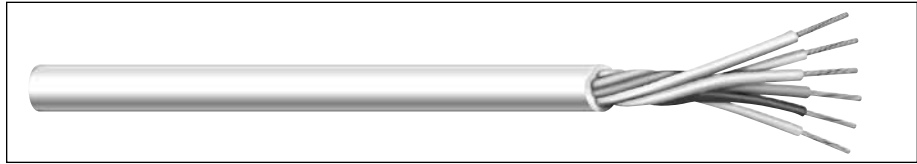

CATALOG NUMBER	NO. OF COND.	AWG SIZE	COND. STRAND	NOM. INSULATION THICKNESS		NOM. JACKET THICKNESS		NOMINAL O.D.		COLOR CODE	NOM. C-C CAP* pF/ft
				INCHES	mm	INCHES	mm	INCHES	mm		
C4100A	2	22	7/30	0.011	0.28	0.032	0.81	0.165	4.19	Black/Red	27.5
C4101A	3	22	7/30	0.011	0.28	0.032	0.81	0.176	4.47	Black/Red/Green	27.5
C4102A	4	22	7/30	0.011	0.28	0.032	0.81	0.189	4.80	1	27.5
C4103A	5	22	7/30	0.011	0.28	0.032	0.81	0.203	5.16	1	27.5
C4104A	6	22	7/30	0.011	0.28	0.032	0.81	0.208	5.28	1	27.5
C4105A	7	22	7/30	0.011	0.28	0.032	0.81	0.218	5.54	1	27.5
C4106A	8	22	7/30	0.011	0.28	0.032	0.81	0.234	5.94	1	27.5
C4107A	9	22	7/30	0.011	0.28	0.032	0.81	0.249	6.32	1	27.5
C4108A	10	22	7/30	0.011	0.28	0.032	0.81	0.268	6.81	1	27.5
C4109A	12	22	7/30	0.011	0.28	0.032	0.81	0.276	7.01	1	27.5
C4110A	15	22	7/30	0.011	0.28	0.032	0.81	0.303	7.70	2	27.5
C4111A	18	22	7/30	0.011	0.28	0.032	0.81	0.318	8.08	2	27.5
C4112A	20	22	7/30	0.011	0.28	0.032	0.81	0.334	8.48	2	27.5
C4113A	25	22	7/30	0.011	0.28	0.032	0.81	0.368	9.35	2	27.5
C4114A	30	22	7/30	0.011	0.28	0.032	0.81	0.389	9.88	2	27.5
C4115A	40	22	7/30	0.011	0.28	0.032	0.81	0.434	11.02	2	27.5
C4116A	50	22	7/30	0.011	0.28	0.032	0.81	0.489	12.42	2	27.5

*Capacitance between conductors
Data subject to change.

Color Code Chart 1- For cables up to and including 12 conductors

NO. OF COND.	COLOR	NO. OF COND.	COLOR
1	Black	7	Orange
2	White	8	Yellow
3	Red	9	Purple
4	Green	10	Gray
5	Brown	11	Pink
6	Blue	12	Tan

Color Code Chart 2 Per ICEA – For cables of 15 thru 50 conductors

NO. OF COND.	COLOR	NO. OF COND.	COLOR	NO. OF COND.	COLOR
1	Black	18	Orange/Red	35	White/Red/Orange
2	White	19	Blue/Red	36	Orange/White/Blue
3	Red	20	Red/Green	37	White/Red/Blue
4	Green	21	Orange/Green	38	Black/White/Green
5	Orange	22	Black/White/Red	39	White/Black/Green
6	Blue	23	White/Black/Red	40	Red/White/Green
7	White/Black	24	Red/Black/White	41	Green/White/Blue
8	Red/Black	25	Green/Black/White	42	Orange/Red/Green
9	Green/Black	26	Orange/Black/White	43	Blue/Red/Green
10	Orange/Black	27	Blue/Black/White	44	Black/White/Blue
11	Blue/Black	28	Black/Red/Green	45	White/Black/Blue
12	Black/White	29	White/Red/Green	46	Red/White/Blue
13	Red/White	30	Red/Black/Green	47	Green/Orange/Red
14	Green/White	31	Green/Black/Orange	48	Orange/Red/Blue
15	Blue/White	32	Orange/Black/Green	49	Blue/Red/Orange
16	Black/Red	33	Blue/White/Orange	50	Black/Orange/Red
17	White/Red	34	Black/White/Orange		

Multi-Conductor, Unshielded

CSA Type AWM I/II A/B, NEC/CEC Type CMG (CSA C/US)

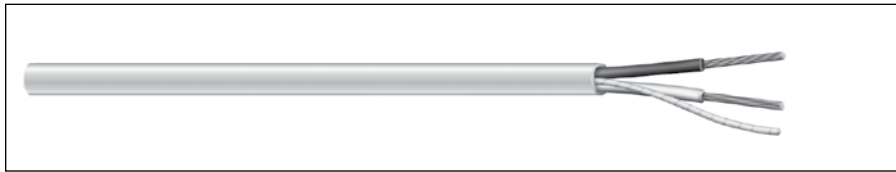

Product Construction:

Conductor:

- 22 thru 14 AWG fully annealed stranded tinned copper per ASTM B33

Insulation:

- Premium-grade, color-coded PVC
- Color code: See charts below

Jacket:

- PVC, gray
- Temperature range: -20°C to +105°C
- Includes ripcord

Applications:

- Public address systems
- Intercoms
- Internal telephones
- Suggested voltage rating: 300 or 600 volts

Compliances:

- CSA Type AWM (105°C, 600 V)
- NEC/CEC Type CMG (CSA: 105°C, 300 V)
- RoHS Compliant Directive 2011/65/EU
- Designed to meet CSA 70,000 BTU Vertical Tray Flame Test
- Passes CSA FT4 Vertical Flame Test
- CE: Low Voltage Directive (LVD) 2006/95/EC

Packaging:

- Please contact Customer Service for packaging and color options

CATALOG NUMBER	NO. OF COND.	AWG SIZE	COND. STRAND	NOM. INS. THICKNESS		NOM. JACKET THICKNESS		NOMINAL O.D.		COLOR CODE	NOM G-C. CAP. pF/ft
				INCHES	mm	INCHES	mm	INCHES	mm		
CSA TYPE AWM, CSA C/US TYPE CMG											
C6700A	2	22	7/30	0.011	0.28	0.016	0.41	0.134	3.40	2	23.5
C6701A	3	22	7/30	0.011	0.28	0.016	0.41	0.142	3.61	2	23.5
C6702A	4	22	7/30	0.011	0.28	0.016	0.41	0.155	3.94	2	23.5
C6704A	6	22	7/30	0.011	0.28	0.016	0.41	0.185	4.70	2	23.5
C6717A	2	20	7/28	0.011	0.28	0.016	0.41	0.148	3.76	2	25.7
C6718A	4	20	7/28	0.011	0.28	0.016	0.41	0.157	3.99	2	25.7
C6725A	2	18	16/30	0.012	0.30	0.016	0.41	0.172	4.37	1	27.3
C6714A	2	18	16/30	0.012	0.30	0.016	0.41	0.172	4.37	2	27.3
C6726A	3	18	16/30	0.012	0.30	0.016	0.41	0.183	4.65	2	27.3
C6727A	4	18	16/30	0.012	0.30	0.016	0.41	0.201	5.11	2	27.3
C6706A	6	18	16/30	0.012	0.30	0.016	0.41	0.242	6.15	2	27.3
C6735A	2	16	19/.0117	0.012	0.30	0.016	0.41	0.192	4.88	2	29.4
C6736A	3	16	19/.0117	0.012	0.30	0.016	0.41	0.204	5.18	2	29.4
C6737A	4	16	19/.0117	0.012	0.30	0.016	0.41	0.226	5.74	2	29.4
CSA TYPE AWM (FT4)											
C6746A	2	14	19/.0147	0.015	0.38	0.016	0.41	0.234	5.94	2	30.8
C6747A	4	14	19/.0147	0.015	0.38	0.016	0.41	0.276	7.01	2	30.8

*A – Capacitance between conductors

*B – Capacitance between one conductor and other conductors connected to shield

Data subject to change.

Color Code Chart 1

NO. OF COND.	COLOR
1	Black
2	Red

Color Code Chart 2

NO. OF COND.	COLOR
1	Black
2	White
3	Red
4	Green
5	Brown
6	Blue
7	Orange
8	Yellow

Power-Limited Tray Cable, Unshielded

NEC Type PLTC, NEC/CEC Type CMG UL/CSA**

Product Construction:

Conductor:

- 22 thru 12 AWG fully annealed stranded tinned copper per ASTM B33

Insulation:

- Premium-grade, color-coded PVC
- Color code: See chart below

Jacket:

- PVC, gray
- Sunlight-resistant
- Temperature range: -20°C to +105°C

Applications:

- Cable tray installations
- Power limited circuits
- Intercom systems
- Business machines
- Cash registers
- Automatic valve control systems
- Irrigation systems
- Suggested voltage rating: 300 volts
- Burglar alarms

Features:

- UL rated for cable tray use

Compliances:

- NEC Article 725 Power-Limited Tray Cable (UL: 105°C, 300 V)
- NEC/CEC Type CMG (UL/CSA: 105°C, 300 V)
- RoHS Compliant Directive 2011/65/EU
- Meets UL 70,000 BTU Vertical Tray Flame Test
- CE: Low Voltage Directive (LVD) 2006/95/EC

Packaging:

- Please contact Customer Service for packaging and color options



CATALOG NUMBER	NO. OF COND.	AWG SIZE	COND. STRAND	NOM. INSULATION THICKNESS		NOM. JACKET THICKNESS		NOMINAL O.D.		NOM. C-C CAP* pF/ft
				INCHES	mm	INCHES	mm	INCHES	mm	
C0431A	2	22	7/30	0.013	0.33	0.037	0.94	0.185	4.70	27.5
C0432A	3	22	7/30	0.013	0.33	0.037	0.94	0.193	4.90	27.5
C0433A	2	20	7/28	0.013	0.33	0.037	0.94	0.198	5.03	30.5
C0434A	3	20	7/28	0.013	0.33	0.037	0.94	0.208	5.28	30.5
C0435A	2	18	16/30	0.013	0.33	0.037	0.94	0.216	5.49	32.5
C0436A	3	18	16/30	0.013	0.33	0.037	0.94	0.227	5.77	32.5
C0444A	4	18	16/30	0.013	0.33	0.037	0.94	0.245	6.22	32.5
C0437A	2	16	19/.0117	0.013	0.33	0.037	0.94	0.238	6.05	37.0
C0438A	3	16	19/.0117	0.013	0.33	0.037	0.94	0.250	6.35	37.0
C0439A*	2	14	19/.0147	0.013	0.33	0.042	1.07	0.278	7.06	40.5
C0440A*	3	14	19/.0147	0.013	0.33	0.042	1.07	0.293	7.44	40.5
C0441A*	2	12	19/.0185	0.013	0.33	0.042	1.07	0.315	8.00	44.0

*NEC Type PLTC Only
 **CSA or c(UL)
 Data subject to change.

Color Code Chart

NO. OF COND.	COLOR
1	Black
2	Red
3	White
4	Green

Multi-Conductor, Foil Shield

NEC Type CL2 and CM (UL) c(UL) CMH

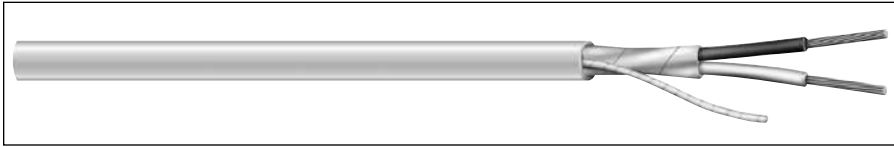

CATALOG NUMBER	NO. OF COND.	AWG SIZE	COND. STRAND	NOM. INSULATION THICKNESS		NOM. JACKET THICKNESS		NOMINAL O.D.		NOM. CAP.*** pF/ft	
				INCHES	mm	INCHES	mm	INCHES	mm	A	B

UL STYLE 2092, CM (UL) C(UL) CMH, 300 V

C2513A	2	24	7/32	0.016	0.41	0.026	0.66	0.167	4.24	18.0	33.0
C2514A	2	22	7/30	0.016	0.41	0.020	0.51	0.167	4.24	20.0	36.0
C2524A	2	20	7/28	0.016	0.41	0.020	0.51	0.183	4.65	22.5	40.5
C2534A	2	18	16/30	0.016	0.41	0.020	0.51	0.201	5.21	25.5	45.5

Polyethylene Insulation, Color Code Chart #1

UL STYLE 2093, CM (UL) c(UL) CMH, 300 V

C2526A	3	22	7/30	0.016	0.41	0.030	0.76	0.196	4.98	18.5	33.5
C2528A	3	20	7/28	0.016	0.41	0.030	0.76	0.210	5.34	21.0	37.5
C2525A	3	20	7/28	0.016	0.41	0.030	0.76	0.213	5.41	21.0	37.0
C2535A	3	18	16/30	0.016	0.41	0.020	0.51	0.213	5.56	23.0	41.0

Polyethylene Insulation, Color Code Chart #1

UL STYLE 2094, CM (UL) c(UL) CMH, 300 V

C2523A	4	22	7/30	0.016	0.41	0.030	0.76	0.213	5.41	18.5	33.5
C2555A	4	20	7/28	0.016	0.41	0.030	0.76	0.234	5.94	20.5	36.5

Polyethylene Insulation, Color Code Chart #1

UL STYLE 2106, CSA, 600 V

C2536A*	2	16	19/.0117	0.031	0.79	0.032	0.81	0.307	7.80	20.0	36.0
C2538A**	2	14	19/.0147	0.031	0.79	0.032	0.81	0.335	8.51	23.0	42.0
C2539A**	2	12	19/.0185	0.032	0.81	0.032	0.81	0.376	9.55	26.0	46.0

* CM (UL) c(UL) CMH

** CL2

Polyethylene Insulation, Color Code Chart #1

UL STYLE 2107, CM (UL) c(UL) CMH, 600 V

C2537A	3	16	19/.0117	0.031	0.79	0.032	0.81	0.325	8.26	19.0	34.0
---------------	---	----	----------	-------	------	-------	------	-------	------	------	------

Polyethylene Insulation, Color Code Chart #1

UL STYLE 2464, CL2/CM (UL) c(UL) CMH, 300 V

C2540A	2	20	7/28	0.013	0.33	0.032	0.81	0.194	4.9	49.7	89.5
---------------	---	----	------	-------	------	-------	------	-------	-----	------	------

PVC Insulation, Color Code Chart #2

CM (UL) c(UL) CMH, 300 V

C2515A	2	22	Solid	0.007	0.18	0.020	0.51	0.124	3.15	30.0	55.0
C2516A	2	22	7/30	0.008	0.20	0.020	0.51	0.137	3.48	28.0	51.0
C2517A	3	22	7/30	0.008	0.20	0.020	0.51	0.144	3.36	25.0	45.0

Polypropylene Insulation, Color Code Chart #2

***A – Capacitance between conductors

***B – Capacitance between one conductor and other conductors connected to shield

Color Code Chart 1

NO. OF COND.	COLOR
1	Black
2	Natural
3	Red
4	Green

Color Code Chart 2

NO. OF COND.	COLOR
1	Black
2	Red
3	Natural

Product Construction:

Conductor:

- 24 thru 12 AWG fully annealed solid or stranded tinned copper per ASTM B33

Insulation:

- Premium-grade, color-coded polyethylene
- Premium-grade, color-coded polypropylene
- Color code: See charts below

Shield:

- 100% Flexfoil® aluminum/polyester, 25% overlap, foil facing out
- Stranded tinned copper drain wire

Jacket:

- PVC, gray
- Temperature range: -20°C to +75°C

Applications:

- Recording studios and sound stages
- Broadcast and sound systems
- Computers
- Industrial equipment control
- Suggested voltage rating: 300 or 600 volts

Compliances:

- UL Style 2092 (UL: 60°C, 300 V)
- UL Style 2093 (UL: 60°C, 300 V)
- UL Style 2094 (UL: 60°C, 300 V)
- UL Style 2106 (UL: 60°C, 600 V)
- UL Style 2107 (UL: 60°C, 600 V)
- UL Style 2464 (UL: 80°C, 300 V)
- NEC Article 725 Type CL2 (UL: 75°C)
- NEC Article 800 Type CM (UL: 75°C)
- RoHS Compliant Directive 2011/65/EU
- Designed to meet UL 70,000 BTU Vertical Tray Flame Test
- CSA CMH (CSA: 60°C)
- Passes CSA CMH Flame Test
- CE: Low Voltage Directive (LVD) 2006/95/EC

Packaging:

- Please contact Customer Service for packaging and color options

Data subject to change.



Multi-Conductor, Foil Shield

UL 2092, NEC Type CM (UL) c(UL) CMH

Product Construction:

Conductor:

- 22 thru 18 AWG fully annealed stranded tinned copper per ASTM B33

Insulation:

- Premium-grade, color-coded polyethylene or polypropylene
- Color code: See charts below

Shield:

- 100% aluminum/polyester foil “bonded” to jacket, foil facing in
- Stranded tinned copper drain wire

Jacket:

- PVC, gray
- Temperature range: -20°C to +75°C

Applications:

- Control circuits
- Data and signal transmission
- Computer interconnections
- Suggested voltage rating: 300 volts

Compliances:

- NEC Article 800 Type CM (UL: 75°C)
- UL Style 2092 (UL: 60°C, 300 V)
- Designed to meet UL 70,000 BTU Vertical Tray Flame Test
- CSA CMH (CSA: 60°C)
- CSA CMG (CSA: 60°C)
- RoHS Compliant Directive 2011/65/EU
- Passes CSA CMH Flame Test
- CE: Low Voltage Directive (LVD) 2006/95/EC

Packaging:

- Please contact Customer Service for packaging and color options



CATALOG NUMBER	NO. OF COND.	AWG SIZE	COND. STRAND	NOM. INSULATION THICKNESS		NOM. JACKET THICKNESS		NOMINAL O.D.		NOM. CAP.* pF/ft	
				INCHES	mm	INCHES	mm	INCHES	mm	A	B

UL STYLE 2092, CM (UL) C(UL) CMH, 300 V

C2518A	2	22	7/30	0.016	0.41	0.026	0.66	0.181	4.60	20.0	36.0
C2519A	2	20	7/28	0.016	0.41	0.028	0.71	0.201	5.11	21.5	38.5
C2521A	2	18	16/30	0.018	0.46	0.028	0.71	0.229	5.82	23.5	43.0

Polyethylene Insulation, Color Code Chart #1

CM (UL) c(UL) CMH, CSA CMG, 300 V

C2520A	2	22	7/30	0.008	0.20	0.020	0.51	0.137	3.48	28.0	50.0
---------------	---	----	------	-------	------	-------	------	-------	------	------	------

Polypropylene Insulation, Color Code Chart #2

*A – Capacitance between conductors

*B – Capacitance between one conductor and other conductors connected to shield

Data subject to change.

Color Code Chart 1

NO. OF COND.	COLOR
1	Black
2	Natural

Color Code Chart 2

NO. OF COND.	COLOR
1	Black
2	Red

Multi-Conductor, Foil Shield

UL 2464, NEC/CEC Type CMG UL/CSA**

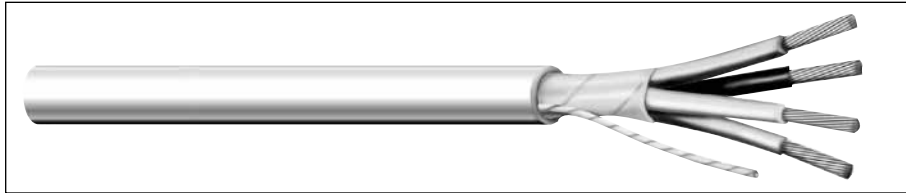

CATALOG NUMBER	NO. OF COND.	AWG SIZE	COND. STRAND	NOM. INSULATION THICKNESS		NOM. JACKET THICKNESS		NOMINAL O.D.		NOM. CAP.*	
				INCHES	mm	INCHES	mm	INCHES	mm	A	B
C2543A	4	18	19/30	0.010	0.25	0.032	0.81	0.238	6.05	47	84.5

*A – Capacitance between conductors

*B – Capacitance between one conductor and other conductors connected to shield

**CSA or c(UL)

Data subject to change.

Color Code Chart

NO. OF COND.	COLOR
1	Black
2	Red
3	White
4	Green

Product Construction:

Conductor:

- 18 AWG fully annealed stranded tinned copper per ASTM B33

Insulation:

- Premium-grade, color-coded S-R PVC
- Color code: See chart below

Shield:

- 100% Flexfoil® aluminum/polyester, 25% overlap, foil facing out
- Stranded tinned copper drain wire

Jacket:

- PVC, gray
- Temperature range: -20°C to +80°C

Applications:

- Audio, broadcast, instrumentation and sound systems
- Suggested voltage rating: 300 volts

Compliances:

- NEC Article 800 Type CM (UL: 75°C)
- UL Style 2464 (UL: 80°C, 300 V)
- CSA CMG (60°C)
- RoHS Compliant Directive 2011/65/EU
- Designed to meet UL 70,000 BTU Vertical Tray Flame Test
- Passes CSA CMG Flame Test
- CE: Low Voltage Directive (LVD) 2006/95/EC

Packaging:

- Please contact Customer Service for packaging and color options



Multi-Conductor, Foil Shield

NEC Type CMP (UL) c(UL)

Product Construction:

Conductor:

- 18 AWG fully annealed stranded tinned copper per ASTM B33

Insulation:

- Premium-grade, color-coded FEP
- Color code: See chart below

Core Wrap:

- Polyester tape with 25% overlap

Shield:

- 100% Flexfoil® aluminum/polyester foil with 25% overlap
- Stranded tinned copper drain wire

Jacket:

- FEP, red
- Chemical-resistant
- Temperature range: -100°C to +200°C

Applications:

- Computer systems
- Remote control circuits
- Process control and instrumentation
- Suitable for outdoor and direct burial
- Suggested voltage rating: 300 volts

Compliances:

- NEC Article 800 Type CM (UL: 75°C)
- Designed to meet NFPA 262 and CSA FT6 Steiner Tunnel Fire Tests for Plenum Applications
- CE: Low Voltage Directive (LVD) 2006/95/EC

Packaging:

- Please contact Customer Service for packaging and color options



CATALOG NUMBER	NO. OF COND.	AWG SIZE	COND. STRAND	NOM. INSULATION THICKNESS		NOM. JACKET THICKNESS		NOMINAL O.D.		NOM. CAP.* pF/ft	
				INCHES	mm	INCHES	mm	INCHES	mm	A	B
C8106	3	18	19/30	0.007	0.18	0.014	0.36	0.178	4.27	54.0	95.0
C8114	4	18	19/30	0.007	0.18	0.014	0.36	0.185	4.70	30.0	55.0

*A – Capacitance between conductors

*B – Capacitance between one conductor and other conductors connected to shield

Data subject to change.

Color Code Chart

NO. OF COND.	COLOR
1	Black
2	White
3	Red
4	Green

Multi-Conductor, Foil Shield

NEC Type CMP (UL) c(UL) and/or CL2P

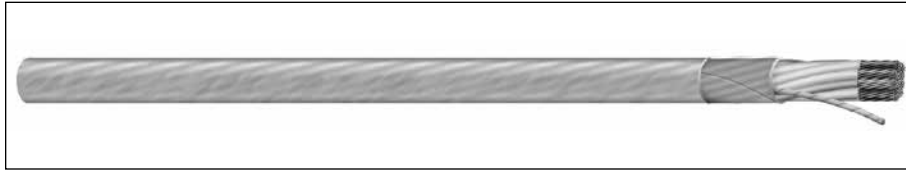

CATALOG NUMBER	NO. OF COND.	AWG SIZE	COND. STRAND	NOM. INSULATION THICKNESS		NOM. JACKET THICKNESS		NOMINAL O.D.		NOM. CAP.**	
				INCHES	mm	INCHES	mm	INCHES	mm	A	B
C3154*	2	22	7/30 TC	0.006	0.15	0.010	0.25	0.103	2.62	51.0	92.0
C3310*	3	22	7/30 TC	0.006	0.15	0.010	0.25	0.116	2.95	45.0	81.0
C3155*	4	22	7/30 TC	0.006	0.15	0.010	0.25	0.130	3.30	45.0	81.0
C3311*	6	22	7/30 TC	0.006	0.15	0.010	0.25	0.152	3.86	40.0	73.0
C3320*	2	20	7/28 TC	0.007	0.18	0.010	0.25	0.120	3.05	53.0	96.0
C3321*	3	20	7/28 TC	0.007	0.18	0.010	0.25	0.136	3.45	46.0	84.0
C3322*	4	20	7/28 TC	0.007	0.18	0.010	0.25	0.153	3.89	46.0	84.0
C3162	2	18	7/26 BC	0.008	0.20	0.010	0.25	0.152	3.86	54.0	98.0
C3164	3	18	7/26 BC	0.008	0.20	0.010	0.25	0.158	4.01	47.0	85.0
C3163	4	18	7/26 BC	0.008	0.20	0.010	0.25	0.178	4.52	47.0	85.0
C3166	6	18	7/26 BC	0.008	0.20	0.010	0.25	0.212	5.38	43.0	76.0
C3180	8	18	7/26 BC	0.008	0.20	0.010	0.25	0.229	5.82	43.0	76.0
C3181	10	18	7/26 BC	0.008	0.20	0.010	0.25	0.273	6.93	43.0	76.0
C3182	12	18	7/26 BC	0.008	0.20	0.012	0.30	0.285	7.24	43.0	76.0
C3169	2	16	19/.0117 BC	0.008	0.20	0.010	0.25	0.181	4.60	62.0	112.0
C3340	3	16	7/.0192 BC	0.008	0.20	0.010	0.25	0.185	4.70	52.0	93.0
C3341	4	16	7/.0192 BC	0.008	0.20	0.010	0.25	0.210	5.16	52.0	93.0

*CL2P only

**A – Capacitance between conductors

**B – Capacitance between one conductor and other conductors connected to shield

Data subject to change.

Color Code Chart

NO. OF COND.	COLOR
1	Black
2	White
3	Red
4	Green
5	Brown
6	Blue
7	Orange
8	Yellow
9	Purple
10	Gray
11	Pink
12	Tan

Product Construction:

Conductor:

- 22 thru 16 AWG fully annealed stranded tinned or bare copper per ASTM B3, B8 or B33
- Class B stranding per ASTM B8

Insulation:

- Halar
- Color code: See chart below

Shield:

- 100% Flexfoil® aluminum/polyester foil, with 25% overlap
- Stranded tinned copper drain wire

Jacket:

- PVDF, natural
- Temperature range: -70°C to +150°C
- Sequential footage marked to facilitate installations
- Includes ripcord

Applications:

- Intercom systems
- Background music
- Audio systems
- Power-limited control circuits
- Suggested voltage rating: 150 volts

Compliances:

- NEC Article 725 (UL: 150°C, 150 V)
- NEC Article 800 (UL: 150°C, 300 V)
- Designed to meet NFPA 262 and CSA FT6 Steiner Tunnel Fire Tests for Plenum Applications
- CE: Low Voltage Directive (LVD) 2006/95/EC

Packaging:

- Please contact Customer Service for packaging and color options



Designed to Meet
NFPA 262 and CSA FT6
Steiner Tunnel Fire Tests
for Plenum Applications

Underwriters Laboratories Inc.



Multi-Conductor, Foil Shield

NEC Type CMP (UL) c(UL) and CL3P

Product Construction:

Conductor:

- 22 thru 16 AWG fully annealed stranded tinned or bare copper per ASTM B3, B8 or B33

Insulation:

- Premium-grade, color-coded Flexguard® PVC
- Color code: See chart below

Shield:

- 100% Flexfoil® aluminum/polyester foil with 25% overlap, minimum
- Stranded tinned copper drain wire

Jacket:

- Flexguard® PVC, natural
- Temperature range: 0°C to +75°C
- Sequential footage marked to facilitate installation
- Includes ripcord

Applications:

- Intercom systems
- Background music
- Audio systems
- Power-limited control circuits
- Suggested voltage rating: 150 volts

Compliances:

- NEC Article 725 (UL: 75°C, 150 V)
- NEC Article 800 (UL: 75°C, 300 V)
- RoHS Compliant Directive 2011/65/EU
- Designed to meet NFPA 262 and CSA FT6 Steiner Tunnel Fire Tests for Plenum Applications
- CE: Low Voltage Directive (LVD) 2006/95/EC

Packaging:

- Please contact Customer Service for packaging and color options

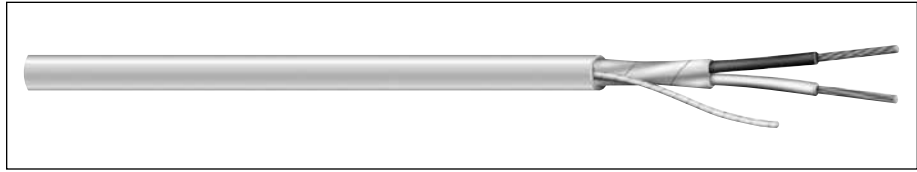

CATALOG NUMBER	NO. OF COND.	AWG SIZE	COND. STRAND	NOM. INSULATION THICKNESS		NOM. JACKET THICKNESS		NOMINAL O.D.		NOM. CAP.*	
				INCHES	mm	INCHES	mm	INCHES	mm	A	B
C3158	2	22	7/30 TC	0.008	0.20	0.015	0.38	0.127	3.23	51.0	91.0
C3159	4	22	7/30 TC	0.008	0.20	0.015	0.38	0.146	3.71	45.0	81.0
C3060	2	18	Solid BC	0.008	0.20	0.015	0.38	0.148	3.76	67.0	120.0
C3061	4	18	Solid BC	0.008	0.20	0.015	0.38	0.171	4.34	58.0	104.0
C3062	2	18	7/26 BC	0.008	0.20	0.015	0.38	0.164	4.17	61.0	110.0
C3064	3	18	7/26 BC	0.008	0.20	0.015	0.38	0.169	4.29	53.0	96.0
C3063	4	18	7/26 BC	0.008	0.20	0.015	0.38	0.185	4.70	53.0	96.0
C3065	6	18	7/26 BC	0.010	0.25	0.015	0.38	0.230	5.84	48.0	86.0
C3183	10	18	7/26 BC	0.010	0.25	0.015	0.38	0.295	7.49	47.0	84.0
C3184	12	18	7/26 BC	0.010	0.25	0.015	0.38	0.308	7.82	52.5	94.6
C3068	2	16	19/.0117 BC	0.009	0.23	0.015	0.38	0.187	4.75	75.0	134.0

*A – Capacitance between conductors
 *B – Capacitance between one conductor and other conductors connected to shield
 Data subject to change.

Color Code Chart

NO. OF COND.	COLOR
1	Black
2	White
3	Red
4	Green
5	Brown
6	Blue
7	Orange
8	Yellow
9	Purple
10	Gray
11	Pink
12	Tan

Multi-Conductor, Foil Shield

Various AWM Styles, CSA Type AWM I/II A/B, NEC/CEC Type CMG (CSA C/US), NEC Type CL2

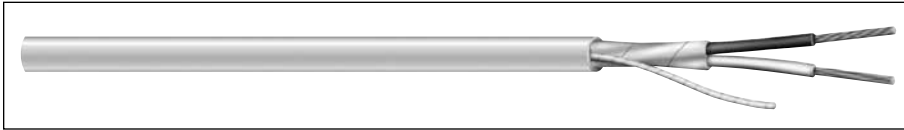

CATALOG NUMBER	NO. OF COND.	AWG SIZE	COND. STRAND	NOM. INSULATION THICKNESS		NOM. JACKET THICKNESS		NOMINAL O.D.		NOM. CAP.* pF/ft	
				INCHES	mm	INCHES	mm	INCHES	mm	A	B

AWM STYLE 20251, CSA TYPE AWM, CSA C/US TYPE CMG

C4152A	2	24	7/32	0.016	0.41	0.026	0.66	0.167	4.24	23.0	42.0
C4153A	2	22	7/30	0.016	0.41	0.026	0.66	0.179	4.55	21.0	38.0
C4154A	2	20	7/28	0.016	0.41	0.030	0.76	0.203	5.16	22.0	40.0
C4155A	2	18	16/30	0.018	0.46	0.030	0.76	0.233	5.92	24.0	43.0
C4156A	3	22	7/30	0.016	0.41	0.030	0.76	0.196	4.98	25.0	45.0
C4157A	3	20	7/28	0.016	0.41	0.030	0.76	0.210	5.33	27.0	51.0
C4158A	3	20	7/28	0.016	0.41	0.030	0.76	0.213	5.41	29.0	52.0
C4159A	3	18	16/30	0.018	0.46	0.030	0.76	0.247	6.27	22.0	40.0
C4160A	4	22	7/30	0.016	0.41	0.030	0.76	0.213	5.41	23.0	42.0
C4161A	4	20	7/28	0.016	0.41	0.030	0.76	0.234	5.94	26.0	74.0

Color Code Chart #1

AWM STYLE 2106, CSA TYPE AWM, CSA C/US TYPE CMG

C4162A	2	16	19/.0117	0.032	0.81	0.032	0.81	0.307	7.80	27.0	49.0
C4165A	3	16	19/.0117	0.032	0.81	0.032	0.81	0.326	8.28	26.0	46.0

Color Code Chart #1

NEC TYPE CL2, AWM STYLE 2464, CSA TYPE AWM

C4163A	2	14	41/30	0.020	0.51	0.032	0.81	0.298	7.57	31.0	56.0
--------	---	----	-------	-------	------	-------	------	-------	------	------	------

Color Code Chart #3

NEC TYPE CL2, AWM STYLE 2106, CSA TYPE AWM

C4164A	2	12	19/.0185	0.032	0.81	0.040	1.02	0.390	9.90	35.0	63.0
--------	---	----	----------	-------	------	-------	------	-------	------	------	------

Color Code Chart #1

AWM STYLE 20251, CSA TYPE AWM, CSA C/US TYPE CMG

C4167A	2	22	Solid	0.007	0.18	0.020	0.51	0.124	3.15	40.0	76.0
C4168A	2	22	7/30	0.008	0.20	0.020	0.51	0.137	3.48	34.0	67.0
C4169A	3	22	7/30	0.008	0.20	0.020	0.51	0.144	3.66	32.0	60.0

Polyethylene Insulation, Color Code Chart #2

*A - Capacitance between conductors

*B - Capacitance between one conductor and other conductors connected to shield

Data subject to change.

Color Code Chart 1

NO. OF COND.	COLOR
1	Black
2	Natural
3	Red
4	Green

Color Code Chart 2

NO. OF COND.	COLOR
1	Black
2	Red
3	Clear

Color Code Chart 3

NO. OF COND.	COLOR
1	Black
2	White

Product Construction:

Conductor:

- 24 thru 12 AWG fully annealed solid or stranded tinned copper per ASTM B33

Insulation:

- Premium-grade, color-coded polypropylene
- Color code: See charts below

Shield:

- 100% Flexfoil® aluminum/polyester, 25% overlap, foil facing out
- Stranded tinned copper drain wire

Jacket:

- PVC, gray
- Temperature range: -20°C to +80°C

Applications:

- Recording studios and sound stages
- Broadcast and sound systems
- Computers
- Industrial equipment control
- Suggested voltage rating: 300 or 600 volts

Compliances:

- AWM Style 20251 (UL: 60°C, 150 V, 300 V peak)
- CSA Type AWM (80°C, 600 V)
- CSA Certified CMG to harmonized standard UL 444 and CSA 22.2 No. 214
- NEC Type CL2/CEC Type CMG (CSA: 80°C, 300 V)
- RoHS Compliant Directive 2011/65/EU
- Designed to meet CSA 70,000 BTU Vertical Tray Flame Test
- Passes CSA FT4 Vertical Flame Test
- CE: Low Voltage Directive (LVD) 2006/95/EC

Packaging:

- Please contact Customer Service for packaging and color options



Multi-Conductor, Foil Shield

AWM Styles 2464, CSA Type AWM I/II A/B, NEC/CEC Type CMG (CSA C/US), or NEC Type CL2

Product Construction:

Conductor:

- 22 thru 12 AWG fully annealed stranded tinned copper per ASTM B33

Insulation:

- Premium-grade, color-coded PVC
- Color code: See charts below

Shield:

- 100% Flexfoil® aluminum/polyester, 25% overlap, foil facing out
- Stranded tinned copper drain wire

Jacket:

- PVC, gray
- Temperature range: -20°C to +105°C

Applications:

- Recording studios and sound stages
- Broadcast and sound systems
- Industrial equipment control
- Suitable for EIA RS-232 applications
- Suggested voltage rating: 300 or 600 volts

Compliances:

- AWM Style 2464 (UL: 80°C, 300 V)
- CSA Type AWM (105°C, 600 V)
- CSA Certified CMG to harmonized standard UL 444 and CSA 22.2 No. 214
- NEC/CEC Type CMG (CSA: 105°C, 300 V)
- RoHS Compliant Directive 2011/65/EU
- Designed to meet CSA 70,000 BTU Vertical Tray Flame Test
- Passes CSA FT4 Vertical Flame Test
- UL Certified CL2 to Standard UL 13
- CE: Low Voltage Directive (LVD) 2006/95/EC

Packaging:

- Please contact Customer Service for packaging and color options

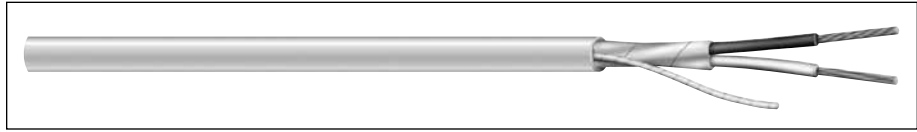

CATALOG NUMBER	NO. OF COND.	AWG SIZE	COND. STRAND	NOM. INSULATION THICKNESS		NOM. JACKET THICKNESS		NOMINAL O.D.		COLOR CODE	NOM. CAP.* pF/ft	
				INCHES	mm	INCHES	mm	INCHES	mm		A	B

AWM STYLE 2464, CSA TYPE AWM, CSA C/US TYPE CMG

C4192A	2	22	7/30	0.011	0.28	0.032	0.81	0.171	4.34	1	47.0	85.0
C4210A	2	22	7/30	0.011	0.28	0.032	0.81	0.171	4.34	2	47.0	85.0
C4193A	3	22	7/30	0.011	0.28	0.032	0.81	0.179	4.55	2	43.0	76.0
C4194A	4	22	7/30	0.011	0.28	0.032	0.81	0.192	4.88	2	43.0	76.0
C4207A	6	22	7/30	0.011	0.28	0.032	0.81	0.218	5.54	2	43.0	76.0
C4208A	8	22	7/30	0.011	0.28	0.032	0.81	0.238	6.05	2	43.0	76.0
C4166A	2	20	7/28	0.012	0.30	0.032	0.81	0.189	4.80	1	46.0	83.0
C4211A	2	20	7/28	0.012	0.30	0.032	0.81	0.189	4.80	2	46.0	83.0
C4195A	3	20	7/28	0.012	0.30	0.032	0.81	0.200	5.08	2	42.0	75.0
C4196A	4	20	7/28	0.012	0.30	0.032	0.81	0.216	5.49	2	42.0	75.0
C4197A	2	18	16/30	0.012	0.30	0.032	0.81	0.205	5.20	1	51.0	92.0
C4212A	2	18	16/30	0.012	0.30	0.032	0.81	0.205	5.20	2	51.0	92.0
C4198A	3	18	16/30	0.012	0.30	0.032	0.81	0.214	5.44	2	46.0	83.0
C4204A	4	18	16/30	0.012	0.30	0.032	0.81	0.236	5.99	2	46.0	83.0
C4205A	6	18	16/30	0.012	0.30	0.032	0.81	0.271	6.88	2	46.0	83.0
C4199A	2	16	19/.0117	0.012	0.30	0.032	0.81	0.229	5.82	1	62.0	112.0
C4213A	2	16	19/.0117	0.012	0.30	0.032	0.81	0.229	5.82	2	62.0	112.0
C4200A	3	16	19/.0117	0.012	0.30	0.032	0.81	0.241	6.12	2	58.0	104.0

AWM STYLE 2464, CSA TYPE AWM (FT4), NEC TYPE CL2*

C4201A	2	14	19/.0147	0.015	0.38	0.032	0.81	0.271	6.88	1	60.0	107.0
C4215A	2	14	19/.0147	0.015	0.38	0.032	0.81	0.271	6.88	2	60.0	107.0
C4202A	2	12	19/.0185	0.015	0.38	0.032	0.81	0.307	7.80	1	64.0	116.0

*A – Capacitance between conductors

*B – Capacitance between one conductor and other conductors connected to shield
Data subject to change.

Color Code Chart 1

NO. OF COND.	COLOR
1	Black
2	Red

Color Code Chart 2

NO. OF COND.	COLOR
1	Black
2	White
3	Red
4	Green
5	Brown
6	Blue
7	Orange
8	Yellow

Multi-Conductor, Foil Shield

AWM Style 2464, CSA Type AWM I/II A/B, NEC/CEC Type CMG (CSA C/US)



CATALOG NUMBER	NO. OF COND.	AWG SIZE	COND. STRAND	NOMINAL INSULATION THICKNESS		NOMINAL JACKET THICKNESS		NOMINAL O.D.		NOMINAL DCR Ω/kft @20°C		NOMINAL CAP.* pF/ft	
				INCHES	mm	INCHES	mm	INCHES	mm	COND.	SHLD.	A	B

AWM STYLE 2464, CSA TYPE AWM, CSA C/US TYPE CMG

C4216A	2	24	7/32	0.010	0.25	0.032	0.81	0.157	3.99	26.0	18.0	40.0	72.0
C4217A	3	24	7/32	0.010	0.25	0.032	0.81	0.164	4.17	26.0	18.0	36.0	66.0
C4218A	4	24	7/32	0.010	0.25	0.032	0.81	0.175	4.45	26.0	18.0	36.0	66.0
C4219A	5	24	7/32	0.010	0.25	0.032	0.81	0.188	4.78	26.0	16.0	36.0	66.0
C4220A	6	24	7/32	0.010	0.25	0.032	0.81	0.201	5.11	26.0	16.0	34.0	61.0
C4221A	7	24	7/32	0.010	0.25	0.032	0.81	0.201	5.11	26.0	16.0	34.0	61.0
C4222A	8	24	7/32	0.010	0.25	0.032	0.81	0.215	5.46	26.0	16.0	34.0	61.0
C4223A	9	24	7/32	0.010	0.25	0.032	0.81	0.228	5.79	26.0	16.0	34.0	61.0
C4224A	10	24	7/32	0.010	0.25	0.032	0.81	0.245	6.22	26.0	14.0	34.0	61.0

Color Code Chart #1

C4225A	15	24	7/32	0.010	0.25	0.032	0.81	0.276	7.01	26.0	14.0	34.0	61.0
C4226A	20	24	7/32	0.010	0.25	0.032	0.81	0.303	7.70	26.0	14.0	34.0	61.0
C4227A	25	24	7/32	0.010	0.25	0.032	0.81	0.333	8.46	26.0	12.0	34.0	61.0
C4228A	30	24	7/32	0.010	0.25	0.032	0.81	0.351	8.92	26.0	12.0	34.0	61.0
C4229A	40	24	7/32	0.010	0.25	0.032	0.81	0.391	9.93	26.0	12.0	34.0	61.0
C4230A	50	24	7/32	0.010	0.25	0.032	0.81	0.439	11.15	26.0	10.0	34.0	61.0

Color Code Chart #2

*A – Capacitance between conductors

*B – Capacitance between one conductor and other conductors connected to shield

Data subject to change.

Color Code Chart 1 – For cables up to and including 10 conductors

NO. OF COND.	COLOR	NO. OF COND.	COLOR
1	Black	6	Blue
2	White	7	Orange
3	Red	8	Yellow
4	Green	9	Purple
5	Brown	10	Gray

Color Code Chart 2 Per ICEA – For cables of 15 to 50 conductors

NO. OF COND.	COLOR	NO. OF COND.	COLOR	NO. OF COND.	COLOR
1	Black	18	Orange/Red	35	White/Red/Orange
2	White	19	Blue/Red	36	Orange/White/Blue
3	Red	20	Red/Green	37	White/Red/Blue
4	Green	21	Orange/Green	38	Black/White/Green
5	Orange	22	Black/White/Red	39	White/Black/Green
6	Blue	23	White/Black/Red	40	Red/White/Green
7	White/Black	24	Red/Black/White	41	Green/White/Blue
8	Red/Black	25	Green/Black/White	42	Orange/Red/Green
9	Green/Black	26	Orange/Black/White	43	Blue/Red/Green
10	Orange/Black	27	Blue/Black/White	44	Black/White/Blue
11	Blue/Black	28	Black/Red/Green	45	White/Black/Blue
12	Black/White	29	White/Red/Green	46	Red/White/Blue
13	Red/White	30	Red/Black/Green	47	Green/Orange/Red
14	Green/White	31	Green/Black/Orange	48	Orange/Red/Blue
15	Blue/White	32	Orange/Black/Green	49	Blue/Red/Orange
16	Black/Red	33	Blue/White/Orange	50	Black/Orange/Red
17	White/Red	34	Black/White/Orange		

Product Construction:

Conductor:

- 24 AWG fully annealed stranded tinned copper per ASTM B33

Insulation:

- Premium-grade, color-coded PVC
- Color code: See charts below

Shield:

- 100% Flexfoil® aluminum/polyester with 25% overlap, foil facing out
- Stranded tinned copper drain wire

Jacket:

- PVC, gray
- Temperature range: -20°C to +105°C

Applications:

- Computer interconnections
- Data transmission
- Control circuits
- Industrial equipment control
- Suitable for EIA RS-232 applications
- Suggested voltage rating: 300 or 600 volts

Compliances:

- AWM Style 2464 (UL: 80°C, 300 V)
- CSA Type AWM (105°C, 600 V)
- CSA Certified CMG to harmonized standard UL 444 and CSA 22.2 No. 214
- NEC/CEC Type CMG (CSA: 105°C, 300 V)
- RoHS Compliant Directive 2011/65/EU
- Designed to meet CSA 70,000 BTU Vertical Tray Flame Test
- Passes CSA FT4 Vertical Flame Test
- CE: Low Voltage Directive (LVD) 2006/95/EC

Packaging:

- Please contact Customer Service for packaging and color options



Multi-Conductor, Foil Shield

CSA Type AWM I/II A/B, NEC/CEC Type CMG (CSA C/US)

Product Construction:

Conductor:

- 22 thru 14 AWG fully annealed stranded tinned copper per ASTM B33

Insulation:

- Premium-grade, color-coded PVC
- Color code: See charts below

Shield:

- 100% Flexfoil® aluminum/polyester foil with 25% overlap, minimum
- Stranded tinned copper drain wire

Jacket:

- PVC, gray
- Temperature range: -20°C to +105°C
- Includes ripcord

Applications:

- Recording studios and sound stages
- Broadcast and sound systems
- Suggested voltage rating: 300 or 600 volts

Compliances:

- CSA Type AWM (105°C, 600 V)
- NEC/CEC Type CMG (CSA: 105°C, 300 V)
- RoHS Compliant Directive 2011/65/EU
- Designed to meet CSA 70,000 BTU Vertical Tray Flame Test
- Passes CSA FT4 Vertical Flame Test
- CE: Low Voltage Directive (LVD) 2006/95/EC

Packaging:

- Please contact Customer Service for packaging and color options

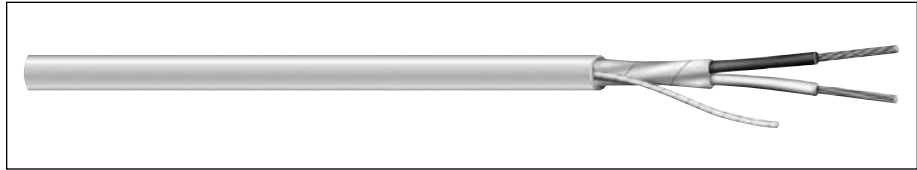

CATALOG NUMBER	NO. OF COND.	AWG SIZE	COND. STRAND	NOM. INS. THICKNESS		NOM. JACKET THICKNESS		NOMINAL O.D.		COLOR CODE	NOM. CAP.*	
				INCHES	mm	INCHES	mm	INCHES	mm		A	B

CSA TYPE AWM, CSA C/US TYPE CMG

C6892A	2	22	7/30	0.011	0.28	0.016	0.41	0.139	3.53	1	37.7	67.8
C6810A	2	22	7/30	0.011	0.28	0.016	0.41	0.139	3.53	2	37.7	67.8
C6893A	3	22	7/30	0.011	0.28	0.016	0.41	0.147	3.73	2	34.3	61.7
C6894A	4	22	7/30	0.011	0.28	0.016	0.41	0.160	4.06	2	34.3	61.7
C6807A	6	22	7/30	0.011	0.28	0.016	0.41	0.190	4.83	2	31.7	57.0
C6866A	2	20	7/28	0.011	0.28	0.016	0.41	0.153	3.89	1	42.2	76.0
C6811A	2	20	7/28	0.011	0.28	0.016	0.41	0.153	3.89	2	38.0	68.4
C6896A	4	20	7/28	0.011	0.28	0.016	0.41	0.177	4.50	2	34.8	62.7
C6897A	2	18	16/30	0.012	0.30	0.016	0.41	0.175	4.45	1	45.4	81.6
C6812A	2	18	16/30	0.012	0.30	0.016	0.41	0.175	4.45	2	45.4	81.6
C6898A	3	18	16/30	0.012	0.30	0.016	0.41	0.185	4.70	2	40.5	72.9
C6804A	4	18	16/30	0.012	0.30	0.016	0.41	0.204	5.18	2	40.5	72.9
C6805A	6	18	16/30	0.012	0.30	0.016	0.41	0.244	6.20	2	36.9	68.4
C6899A	2	16	19/.0117	0.012	0.30	0.016	0.41	0.197	5.00	1	53.6	96.4
C6813A	2	16	19/.0117	0.012	0.30	0.016	0.41	0.197	5.00	2	53.6	96.4
C6800A	3	16	19/.0117	0.012	0.30	0.016	0.41	0.209	5.31	2	47.0	84.6
C6837A	4	16	19/.0117	0.012	0.30	0.016	0.41	0.231	5.87	2	47.0	84.6

CSA TYPE AWM (FT4)

C6801A	2	14	19/.0147	0.015	0.38	0.016	0.41	0.239	6.07	1	54.0	97.2
C6815A	2	14	19/.0147	0.015	0.38	0.016	0.41	0.239	6.07	2	54.0	97.2

*A – Capacitance between conductors

*B – Capacitance between one conductor and other conductors connected to shield

Data subject to change.

Color Code Chart 1

NO. OF COND.	COLOR
1	Black
2	Red

Color Code Chart 2

NO. OF COND.	COLOR
1	Black
2	White
3	Red
4	Green
5	Brown
6	Blue
7	Orange
8	Yellow

Power-Limited Tray Cable, Foil Shield

NEC Type PTLTC, NEC/CEC Type CMG UL/CSA**

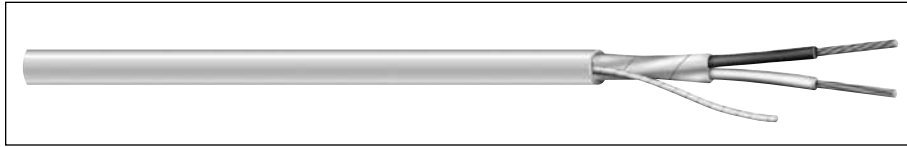

CATALOG NUMBER	NO. OF COND.	AWG SIZE	COND. STRAND	NOM. INSULATION THICKNESS		NOM. JACKET THICKNESS		NOMINAL O.D.		NOM. CAP.* pF/ft	
				INCHES	mm	INCHES	mm	INCHES	mm	A	B
C0450A	2	22	7/30	0.013	0.33	0.037	0.94	0.191	4.85	43.0	77.5
C0451A	3	22	7/30	0.013	0.33	0.037	0.94	0.199	5.05	39.5	71.0
C0452A	2	20	7/28	0.013	0.33	0.037	0.94	0.207	5.26	48.5	87.0
C0453A	3	20	7/28	0.013	0.33	0.037	0.94	0.217	5.51	44.0	79.0
C0454A	2	18	16/30	0.013	0.33	0.037	0.94	0.221	5.61	54.5	98.0
C0455A	3	18	16/30	0.013	0.33	0.037	0.94	0.232	5.89	49.0	88.0
C0456A	2	16	19/.0117	0.013	0.33	0.037	0.94	0.243	6.17	64.0	115.5
C0457A	3	16	19/.0117	0.013	0.33	0.037	0.94	0.255	6.48	56.5	102.0
C0458A**	2	14	19/.0147	0.013	0.33	0.042	1.07	0.288	7.32	72.5	131.0
C0459A**	3	14	19/.0147	0.013	0.33	0.042	1.07	0.298	7.57	63.0	113.5
C0460A**	2	12	19/.0185	0.013	0.33	0.042	1.07	0.315	8.00	80.5	145.0

*NEC Type PLTC Only

**CSA or c(UL)

Data subject to change.

Color Code Chart

NO. OF COND.	COLOR
1	Black
2	Red
3	White

Product Construction:

Conductor:

- 22 thru 12 AWG fully annealed stranded tinned copper per ASTM B33

Insulation:

- Premium-grade, color-coded PVC
- Color code: See chart below

Shield:

- 100% Flexfoil® aluminum/polyester, 25% overlap foil facing out
- Stranded tinned copper drain wire

Jacket:

- PVC, gray
- Sunlight-resistant
- Temperature range: -20°C to +105°C

Applications:

- Cable tray installations
- Power limited circuits
- Intercom systems
- Business machines
- Cash registers
- Industrial control systems
- Petrochemical refineries
- Suggested voltage rating: 300 volts
- Burglar alarms
- UL tray cable rated

Compliances:

- NEC Article 725 Power-Limited Tray Cable (UL: 105°C, 300 V)
- NEC/CEC Type CMG (UL/CSA: 105°C, 300 V)
- RoHS Compliant Directive 2011/65/EU
- Meets UL 70,000 BTU Vertical Tray Flame Test
- CE: Low Voltage Directive (LVD) 2006/95/EC

Packaging:

- Please contact Customer Service for packaging and color options



Designed to Meet
UL Vertical Tray
Flame Test

Underwriters Laboratories Inc.



Multi-Conductor, Spiral Shield

UL 2095, NEC Type CL2, NEC/CEC Type CMG UL/CSA**

Product Construction:

Conductor:

- 22 thru 16 AWG fully annealed stranded tinned copper per ASTM B33

Insulation:

- Premium-grade, color-coded PVC
- Color code: See charts below

Shield:

- 85% spiral tinned copper

Jacket:

- PVC, gray
- Temperature range: -20°C to +80°C

Applications:

- Electronic circuits where RF shielding is required
- Radio transmitters
- Sound systems
- Recording studios
- Suggested voltage rating: 300 volts

Compliances:

- NEC Article 800 Type CM (UL: 75°C)
- UL Style 2095 (UL: 80°C, 300 V)
- CSA CMG (CSA: 60°C)
- RoHS Compliant Directive 2011/65/EU
- Designed to meet UL 70,000 BTU Vertical Tray Flame Test
- Passes CSA CMG Flame Test
- NEC Article 725 Type CL2 (UL: 75°C)
- CE: Low Voltage Directive (LVD) 2006/95/EC

Packaging:

- Please contact Customer Service for packaging and color options

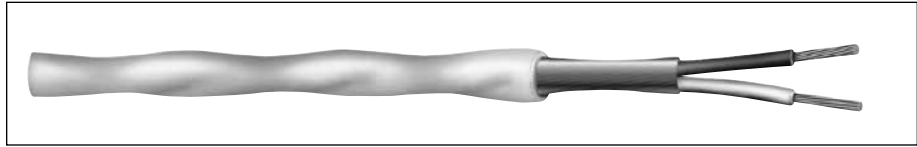

CATALOG NUMBER	NO. OF COND.	AWG SIZE	COND. STRAND	NOM. INSULATION THICKNESS		NOM. JACKET THICKNESS		NOMINAL O.D.		NOM. CAP.* pF/ft	
				INCHES	mm	INCHES	mm	INCHES	mm	A	B

UL STYLE 2095, CM (UL) c(UL), CSA CMG, 300 V

C2882A	2	22	7/30	0.015	0.38	0.032	0.81	0.197	5.00	40.0	72.0
C2888A	2	20	7/28	0.016	0.41	0.032	0.81	0.215	5.46	44.0	80.2

Color Code Chart #1

CL2/CM (UL) c(UL), CSA CMG, 300 V

C1335A	3	22	7/30	0.015	0.38	0.032	0.81	0.206	5.23	37.0	67.0
C1337A	4	22	7/30	0.015	0.38	0.032	0.81	0.222	5.64	37.0	67.0
C1341A	6	22	7/30	0.015	0.38	0.032	0.81	0.257	6.53	34.5	62.0
C2768A	3	18	7/26	0.020	0.51	0.032	0.81	0.266	6.76	41.0	74.0

Color Code Chart #1

CM (UL) c(UL), CSA CMG, 300 V

C2892A	2	18	16/30	0.016	0.41	0.032	0.81	0.252	6.40	49.5	89.0
C2895A	2	16	19/.0117	0.016	0.41	0.032	0.81	0.265	6.73	58.0	104.0

Color Code Chart #2

*A – Capacitance between conductors

*B – Capacitance between one conductor and other conductors connected to shield

**CSA or c(UL)

Data subject to change.

Color Code Chart 1

NO. OF COND.	COLOR
1	Black
2	Red
3	White
4	Green
5	Yellow
6	Blue

Color Code Chart 2

CATALOG NUMBER	CONDUCTOR	COLOR
C2892A	1	White
	2	Red
C2895A	1	White
	2	Black

Multi-Conductor, Braid Shield

NEC Type CL2 and CM(UL) c(UL)

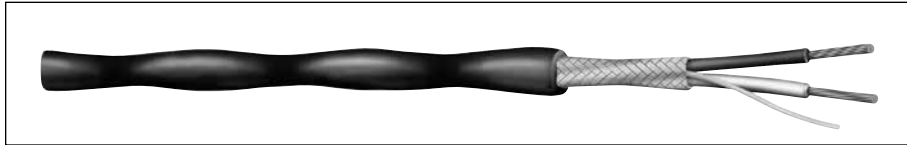

CATALOG NUMBER	NO. OF COND.	AWG SIZE	COND. STRAND	NOM. INSULATION THICKNESS		NOM. JACKET THICKNESS		NOMINAL O.D.		NOM. CAP.* pF/ft	
				INCHES	mm	INCHES	mm	INCHES	mm	A	B
C2676A	2	22	Solid	0.015	0.38	0.032	0.81	0.209	5.31	38.6	69.4
C2677A	2	22	7/30	0.015	0.38	0.032	0.81	0.211	5.36	39.3	70.7

A – Capacitance between conductors

*B – Capacitance between one conductor and other conductors connected to shield

Data subject to change.

Color Code Chart

NO. OF COND.	COLOR
1	Black
2	Red

Product Construction:

Conductor:

- 22 AWG fully annealed solid or stranded tinned copper per ASTM B33

Insulation:

- Premium-grade, color-coded PVC
- Color code: See chart below

Shield:

- 88% tinned copper braid
- Stranded or solid tinned copper drain wire

Jacket:

- PVC, black
- Temperature range: -20°C to +75°C

Applications:

- Electronic circuits where RF shielding is required
- Radio transmitters
- Sound systems
- Recording studios
- Good flexibility
- Excellent shielding for noise reduction
- Suggested voltage rating: 300 volts

Compliances:

- NEC Article 800 Type CM (UL: 75°C)
- RoHS Compliant Directive 2011/65/EU
- Designed to meet UL 70,000 BTU Vertical Tray Flame Test
- NEC Article 725 Type CL2 (UL: 75°C)
- CE: Low Voltage Directive (LVD) 2006/95/EC

Packaging:

- Please contact Customer Service for packaging and color options



Designed to Meet
UL Vertical Tray
Flame Test

Underwriters Laboratories Inc.



Multi-Conductor, Braid Shield

UL 2092, 2093, 2094, NEC Type CM (UL) c(UL) CMH

Product Construction:

Conductor:

- 20 AWG fully annealed stranded tinned copper per ASTM B33

Insulation:

- Premium-grade, color-coded polyethylene
- Color code: See chart below

Shield:

- 80% tinned copper braid
- Mylar wrap under braid

Jacket:

- PVC, gray
- Temperature range: -20°C to +75°C

Applications:

- Electronic circuits where RF shielding is required
- Video interconnect
- Broadcast and studio
- Sound systems
- Suggested voltage rating: 300 volts

Compliances:

- NEC Article 800 Type CM/CMH (UL: 75°C)
- AWM style 2092 (UL: 60°C, 300 V)
- AWM style 2093 (UL: 60°C, 300 V)
- AWM style 2094 (UL: 60°C, 300 V)
- RoHS Compliant Directive 2011/65/EU
- Designed to meet UL VW-1 Vertical Wire Flame Test
- CE: Low Voltage Directive (LVD) 2006/95/EC

Packaging:

- Please contact Customer Service for packaging and color options

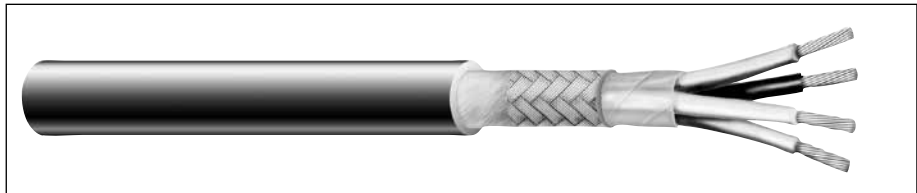

CATALOG NUMBER	NO. OF COND.	AWG SIZE	COND. STRAND	NOM. INSULATION THICKNESS		NOM. JACKET THICKNESS		NOMINAL O.D.		NOM. CAP.* pF/ft	
				INCHES	mm	INCHES	mm	INCHES	mm	A	B

AWM STYLE 2092, CM (UL) c(UL) CMH, 300 V

C1642A	2	20	26/34	0.016	0.38	0.029	0.74	0.226	5.74	24.0	43.0
---------------	---	----	-------	-------	------	-------	------	-------	------	------	------

AWM STYLE 2093, CM (UL) c(UL) CMH, 300 V

C1643A	3	20	26/34	0.016	0.38	0.029	0.74	0.236	5.99	22.0	40.0
---------------	---	----	-------	-------	------	-------	------	-------	------	------	------

AWM STYLE 2094, CM (UL) c(UL) CMH 300 V

C1644A	4	20	26/34	0.016	0.38	0.029	0.74	0.255	6.48	22.0	39.0
C1645A	5	20	26/34	0.016	0.38	0.029	0.74	0.274	6.96	22.0	39.0
C1646A	6	20	26/34	0.016	0.38	0.029	0.74	0.290	7.37	20.0	36.0

*A – Capacitance between conductors

*B – Capacitance between one conductor and other conductors connected to shield

Data subject to change.

Color Code Chart

NO. OF COND.	COLOR
1	Black
2	White
3	Red
4	Green
5	Yellow
6	Blue

Multi-Conductor, Braid Shield

UL 2095, NEC/CEC Type CMG UL/CSA**

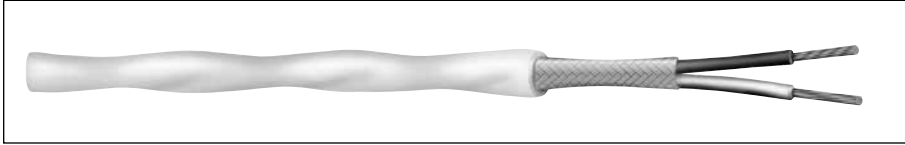

CATALOG NUMBER	NO. OF COND.	AWG SIZE	COND. STRAND	NOM. INSULATION THICKNESS		NOM. JACKET THICKNESS		NOMINAL O.D.		NOM. CAP.* pF/ft	
				INCHES	mm	INCHES	mm	INCHES	mm	A	B
C2679A	2	22	7/30	0.016	0.41	0.032	0.81	0.212	5.38	40.0	72.0
C2678A	3	22	7/30	0.016	0.41	0.032	0.81	0.221	5.61	37.0	67.0
C2680A	4	22	7/30	0.016	0.41	0.032	0.81	0.237	6.02	37.0	67.0
C2681A	2	20	7/28	0.016	0.41	0.032	0.81	0.230	5.84	44.0	80.0
C1332A	3	20	7/28	0.016	0.41	0.032	0.81	0.240	6.10	40.0	72.0
C2683A	4	20	7/28	0.016	0.41	0.032	0.81	0.259	6.58	40.0	73.0
C2686A	2	18	16/30	0.016	0.41	0.032	0.81	0.252	6.40	49.0	89.0
C2687A	3	18	16/30	0.016	0.41	0.032	0.81	0.264	6.71	45.0	80.5
C2688A	4	18	16/30	0.016	0.41	0.032	0.81	0.286	7.26	45.0	80.5
C2689A	2	16	19/29	0.020	0.51	0.032	0.81	0.280	7.11	51.0	91.0

*A – Capacitance between conductors

*B – Capacitance between one conductor and other conductors connected to shield

**CSA or c(UL)

Data subject to change.

Color Code Chart

NO. OF COND.	COLOR
1	Black
2	Red
3	White
4	Green

Product Construction:

Conductor:

- 22 thru 16 AWG fully annealed stranded tinned copper per ASTM B33

Insulation:

- Premium-grade, color-coded PVC
- Color code: See chart below

Shield:

- 75% tinned copper braid

Jacket:

- PVC, gray
- Temperature range: -20°C to +80°C

Applications:

- Electronic circuits where RF shielding is required
- Radio transmitters
- Sound systems
- Recording studios
- Provides good flexibility
- Excellent shielding for noise reduction
- Suggested voltage rating: 300 volts

Compliances:

- NEC Article 800 Type CM (UL: 75°C)
- UL Style 2095 (UL: 80°C, 300 V)
- RoHS Compliant Directive 2011/65/EU
- Designed to meet UL 70,000 BTU Vertical Tray Flame Test
- CSA CMG (CSA: 60°C)
- Passes CSA CMG Flame Test
- CE: Low Voltage Directive (LVD) 2006/95/EC

Packaging:

- Please contact Customer Service for packaging and color options



Multi-Conductor, Braid Shield

MIL-W-16878 Type B

Product Construction:

Conductor:

- 28 AWG fully annealed stranded tinned copper per ASTM B33

Insulation:

- Premium-grade, color-coded PVC per MIL-W-16878 Type B
- Color code: See chart below

Shield:

- 90% tinned copper braid

Jacket:

- PVC, gray
- Temperature range: -20°C to +90°C

Applications:

- Electronic circuits where RF shielding is required
- Remote control for studio equipment
- Sound systems
- Provides good flexibility
- Excellent shielding for noise reduction
- Suggested voltage rating: 600 volts
- Non QPL

Compliances:

- RoHS Compliant Directive 2011/65/EU
- CE: Low Voltage Directive (LVD) 2006/95/EC

Packaging:

- Please contact Customer Service for packaging and color options

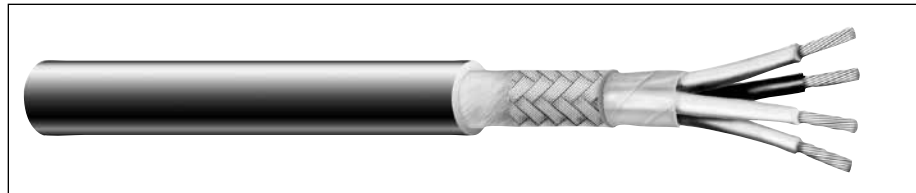

CATALOG NUMBER	NO. OF COND.	AWG SIZE	COND. STRAND	NOM. INSULATION THICKNESS		NOM. JACKET THICKNESS		NOMINAL O.D.		NOM. CAP.* pF/ft	
				INCHES	mm	INCHES	mm	INCHES	mm	A	B
C6500A	2	28	7/36	0.010	0.28	0.016	0.41	0.130	3.30	34.0	61.0
C6501A	3	28	7/36	0.010	0.28	0.016	0.41	0.135	3.30	32.5	58.5
C6502A	4	28	7/36	0.010	0.28	0.016	0.41	0.145	3.68	32.5	58.5
C6503A	6	28	7/36	0.010	0.28	0.019	0.48	0.172	4.37	30.5	55.0
C6504A	8	28	7/36	0.010	0.28	0.021	0.53	0.187	4.75	30.5	55.0
C6505A	10	28	7/36	0.010	0.28	0.021	0.53	0.212	5.38	30.5	55.0
C6506A	12	28	7/36	0.010	0.28	0.021	0.53	0.217	5.51	30.5	55.0
C6507A	15	28	7/36	0.010	0.28	0.021	0.53	0.237	6.01	30.5	55.0
C6508A	20	28	7/36	0.010	0.28	0.021	0.53	0.259	6.58	30.5	55.0

*A – Capacitance between conductors

*B – Capacitance between one conductor and other conductors connected to shield

Data subject to change.

Color Code Chart

NO. OF COND.	COLOR	NO. OF COND.	COLOR	NO. OF COND.	COLOR
1	Black	8	Red/Black	15	Blue/White
2	White	9	Green/Black	16	Black/Red
3	Red	10	Orange/Black	17	White/Red
4	Green	11	Blue/Black	18	Orange/Red
5	Orange	12	Black/White	19	Blue/Red
6	Blue	13	Red/White	20	Red/Green
7	White/Black	14	Green/White		

Multi-Conductor, Foil/Braid Shield

UL 2094, NEC Type CL2

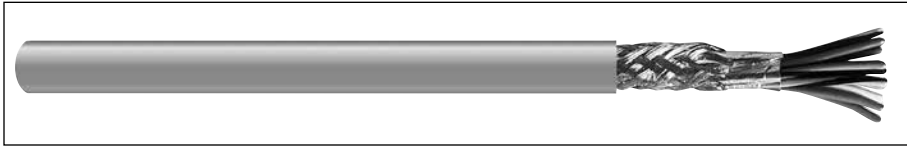

CATALOG NUMBER	NO. OF COND.	AWG SIZE	COND. STRAND	NOM. INSULATION THICKNESS		NOM. JACKET THICKNESS		NOMINAL O.D.		NOM. CAP.* pF/ft	
				INCHES	mm	INCHES	mm	INCHES	mm	A	B
C1648A	8	20	26/34	0.016	0.38	0.029	0.74	0.316	8.03	20.0	36.0

*A – Capacitance between conductors

*B – Capacitance between one conductor and other conductors connected to shield

Data subject to change.

Color Code Chart

NO. OF COND.	COLOR	NO. OF COND.	COLOR
1	Black	5	Yellow
2	White	6	Blue
3	Red	7	Brown
4	Green	8	Orange

Product Construction:

Conductor:

- 20 AWG fully annealed stranded tinned copper per ASTM B33

Insulation:

- Premium-grade, color-coded polyethylene
- Color code: See chart below

Shield:

- 100% Flexfoil® aluminum/polyester, 25% overlap, foil facing out
- 80% tinned copper braid

Jacket:

- PVC, gray
- Temperature range: -20°C to +75°C

Applications:

- Electronic circuits where RF shielding is required
- Video interconnect
- Broadcast and studio
- Sound systems
- Suggested voltage rating: 300 volts

Compliances:

- NEC Article 725 Type CL2 (UL: 75°C)
- UL Style 2094 (UL: 60°C, 300 V)
- RoHS Compliant Directive 2011/65/EU
- Designed to meet UL 70,000 BTU Vertical Tray Flame Test
- CE: Low Voltage Directive (LVD) 2006/95/EC

Packaging:

- Please contact Customer Service for packaging and color options



Designed to Meet
UL Vertical Tray
Flame Test

Underwriters Laboratories Inc.



Multi-Conductor, Foil & TC Braid Shield

NEC Type CMP (UL) c(UL)

Product Construction:

Conductor:

- Fully annealed stranded tinned copper per ASTM B33

Insulation:

- Premium-grade, color-coded FEP
- Color code: See chart below

Core Wrap:

- Polyester tape with 25% overlap

Shield:

- 100% Flexfoil® aluminum/polyester foil with 25% overlap
- 90% tinned copper braid

Jacket:

- FEP, red
- Temperature range: -100°C to +200°C

Applications:

- Computer systems
- Remote control circuits
- Process control and instrumentation
- Audio controls
- Suggested voltage rating: 300 volts

Compliances:

- NEC Article 800
- Designed to meet NFPA 262 and CSA FT6 Steiner Tunnel Fire Tests for Plenum Applications
- CE: Low Voltage Directive (LVD) 2006/95/EC

Packaging:

- Please contact Customer Service for packaging and color options



CATALOG NUMBER	NO. OF COND.	AWG SIZE	COND. STRAND	NOM. INSULATION THICKNESS		NOM. JACKET THICKNESS		NOMINAL O.D.		NOM. CAP.* pF/ft	
				INCHES	mm	INCHES	mm	INCHES	mm	A	B

16 AWG CONDUCTORS

C8108	6	16	19/29	0.007	0.18	0.014	0.36	0.270	6.86	33.0	61.0
C8119	3	16	19/29	0.007	0.18	0.014	0.36	0.209	5.31	35.0	63.0
C8111	2	16	19/29	0.007	0.18	0.014	0.36	0.198	5.03	35.0	63.0

18 AWG CONDUCTORS

C8120	6	18	19/30	0.007	0.18	0.014	0.36	0.242	6.15	33.0	61.0
C8110	4	18	19/30	0.007	0.18	0.014	0.36	0.206	5.23	35.0	63.0
C8107	3	18	19/30	0.007	0.18	0.014	0.36	0.190	4.83	35.0	63.0

24 AWG CONDUCTORS

C8115	3	24	7/32	0.006	0.15	0.014	0.36	0.133	3.38	25.0	45.0
--------------	---	----	------	-------	------	-------	------	-------	------	------	------

*A – Capacitance between conductors

*B – Capacitance between one conductor and other conductors connected to shield

Data subject to change.

Color Code Chart

NO. OF COND.	COLOR
1	Black
2	White
3	Red
4	Green
5	Orange
6	Blue

Multi-Conductor, Rubber, Unshielded

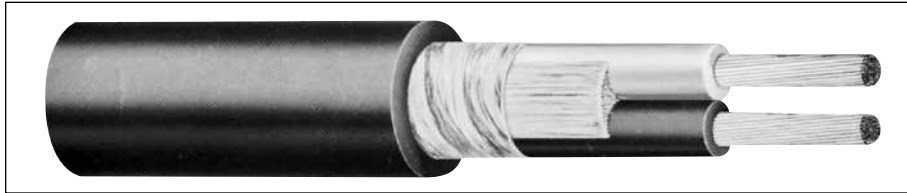

CATALOG NUMBER	NO. OF COND.	AWG SIZE	COND. STRAND	NOM. INSULATION THICKNESS		NOM. JACKET THICKNESS		NOMINAL O.D.	
				INCHES	mm	INCHES	mm	INCHES	mm
C3602	2	20	26/34	0.020	0.51	0.035	0.89	0.016	0.406
C3603	3	20	26/34	0.020	0.51	0.035	0.89	0.016	0.406
C3604	4	20	26/34	0.020	0.51	0.035	0.89	0.016	0.406
C3605	5	20	26/34	0.020	0.51	0.035	0.89	0.016	0.406
C3606	6	20	26/34	0.020	0.51	0.035	0.89	0.016	0.406
C3607	7	20	26/34	0.020	0.51	0.035	0.89	0.016	0.406
C3608	8	20	26/34	0.020	0.51	0.035	0.89	0.016	0.406
C3610	10	20	26/34	0.020	0.51	0.035	0.89	0.016	0.406

Data subject to change.

Color Code Chart

NO. OF COND.	COLOR
1	Black
2	White
3	Red
4	Green
5	Orange
6	Blue
7	Yellow
8	Brown
9	White/Black
10	Red/Black

Product Construction:

Conductor:

- 20 AWG fully annealed stranded tinned copper per ASTM B33

Insulation:

- Premium-grade, color-coded rubber
- Color code: See chart below

Jacket:

- Rubber, black
- Temperature range: -20°C to +60°C

Applications:

- Energy management systems
- Control circuits
- Fire alarm control
- Broadcast and studio requirements
- Suggested voltage rating: 350 volts

Features:

- Excellent impact resistance
- High level of abrasion resistance
- High flexibility
- Excellent mechanical strength
- Excellent moisture resistance

Compliances:

- RoHS Compliant Directive 2011/65/EU

Packaging:

- Please contact Customer Service for packaging and color options

Multi-Conductor, Rubber, Braid Shield

Product Construction:

Conductor:

- 20 AWG fully annealed stranded tinned copper per ASTM B33

Insulation:

- Premium-grade, color-coded rubber
- Color code: See chart below

Shield:

- 80% tinned copper braid

Jacket:

- Rubber, black
- Temperature range: -20°C to +60°C

Applications:

- Control circuits
- Broadcast and studio applications
- Audio interconnects
- Suggested voltage rating: 300 volts

Features:

- Impact- and abrasion-resistant
- Stranded conductors for superior flexibility

Compliances:

- RoHS Compliant Directive 2011/65/EU

Packaging:

- Please contact Customer Service for packaging and color options

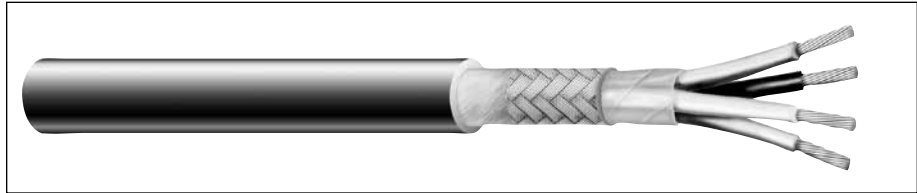

CATALOG NUMBER	NO. OF COND.	AWG SIZE	COND. STRAND	NOM. INSULATION THICKNESS		NOM. JACKET THICKNESS		NOMINAL O.D.	
				INCHES	mm	INCHES	mm	INCHES	mm
C1302	2	20	26/34	0.020	0.51	0.035	0.89	0.270	6.86
C1304	3	20	26/34	0.020	0.51	0.035	0.89	0.285	7.24
C1305	4	20	26/34	0.020	0.51	0.035	0.89	0.300	7.62
C1308	5	20	26/34	0.020	0.51	0.035	0.89	0.330	8.38
C1310	6	20	26/34	0.020	0.51	0.035	0.89	0.340	8.64
C1312	7	20	26/34	0.020	0.51	0.035	0.89	0.355	9.02
C1313	8	20	26/34	0.020	0.51	0.035	0.89	0.385	9.78

Data subject to change.

Color Code Chart

NO. OF COND.	COLOR	NO. OF COND.	COLOR
1	Black	5	Orange
2	White	6	Blue
3	Red	7	Yellow
4	Green	8	Brown

Multi-Conductor, Carolprene® , Braid Shield

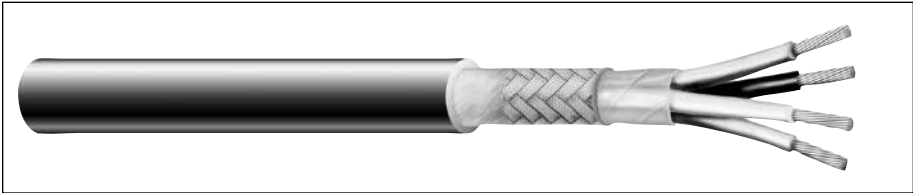

CATALOG NUMBER	NO. OF COND.	AWG SIZE	COND. STRAND	NOM. INSULATION THICKNESS		NOM. JACKET THICKNESS		NOMINAL O.D.	
				INCHES	mm	INCHES	mm	INCHES	mm
C1202	2	18	41/34	0.020	0.51	0.035	0.89	0.295	7.49
C1203	3	18	41/34	0.020	0.51	0.035	0.89	0.305	7.75
C1204	4	18	41/34	0.020	0.51	0.035	0.89	0.330	8.38
C1206	6	18	41/34	0.020	0.51	0.035	0.89	0.370	9.39
C1602	2	16	65/34	0.025	0.64	0.035	0.89	0.335	8.51
C1603	3	16	65/34	0.025	0.64	0.035	0.89	0.355	9.02
C1604	4	16	65/34	0.025	0.64	0.035	0.89	0.385	9.78

Data subject to change.

Color Code Chart

NO. OF COND.	COLOR
1	Black
2	White
3	Red
4	Green
5	Blue
6	Brown

Product Construction:

Conductor:

- 18 thru 14 AWG fully annealed stranded tinned copper per ASTM B33

Insulation:

- Premium-grade, color-coded rubber
- Color code: See chart below

Shield:

- 80% tinned copper braid

Jacket:

- Carolprene®, black
- Temperature range: -20°C to +60°C

Applications:

- Control circuits
- Broadcast and studio applications
- Audio interconnects
- Suggested voltage rating: 300 volts

Features:

- Impact- and abrasion-resistant
- Stranded conductors for superior flexibility
- Designed to meet UL VW-1 Vertical Wire Flame Test

Compliance:

- RoHS Compliant Directive 2011/65/EU

Packaging:

- Please contact Customer Service for packaging and color options

Communication & Control Cable, Multi-Paired

2

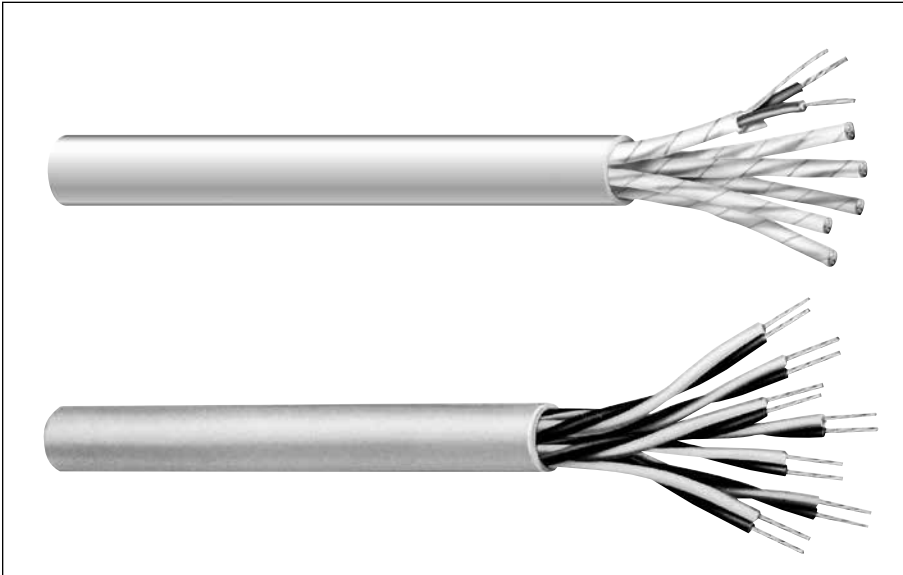

In many electronic applications, two wires are required to complete circuits; these are often referred to as “balanced arrays” or “twisted pair” constructions.

Paired cable designs find frequent application in circuits requiring circuit-to-circuit isolation from noise, minimization of capacitance imbalances and a reduction of EMI interference currents.

Circuit separation is further enhanced in those designs employing individual circuit shields in concert with an overall shield. These shielding systems are available from General Cable in myriad combinations to suit the unique needs of the circuit designer.

As with the multi-conductor designs, a wide array of insulating and jacketing materials are available to meet specific electronic applications.

General Cable’s Carol® Brand communication cable products are manufactured to meet the latest UL, CSA and NEC requirements and approvals.

Index	Page
Multi-Paired, Unshielded	38-40
Multi-Paired, Foil Shield	41-47
Multi-Paired, Foil Shield (CSA)	48-49
Multi-Paired, Foil Shield, Mid-Cap	50
Multi-Paired, Foil Shield, Lo-Cap®	51
Multi-Paired, Overall Foil & TC Braid Shield, Lo-Cap	52
Multi-Paired, Individually Shielded (UL)	53
Multi-Paired, Individually Shielded (CSA)	54
Multi-Paired, Individually Shielded (UL/CSA)	55
Multi-Paired, Individually Foil Shielded	56-59
Power-Limited Tray Cable, Individually Shielded	60
Power-Limited Tray Cable, Foil Shield	61

Multi-Paired, Unshielded

UL 2464, NEC/CEC Type CMG UL/CSA**



Product Construction:

Conductor:

- 22 AWG fully annealed solid or stranded tinned copper per ASTM B33
- Twisted pairs

Insulation:

- Premium-grade, color-coded S-R PVC
- Color code: See chart below

Jacket:

- PVC, gray
- Temperature range: -20°C to +80°C

Applications:

- Computers
- Industrial equipment
- Data transmission
- Control circuits
- Suitable for EIA RS-232 applications
- Suggested voltage rating: 300 volts

Compliances:

- NEC Article 800 Type CM (UL: 75°C)
- UL Style 2464 (UL: 80°C, 300 V)
- CSA CMG (CSA: 60°C)
- RoHS Compliant Directive 2011/65/EU
- Designed to meet UL 70,000 BTU Vertical Tray Flame Test
- Passes CSA CMG Flame Test

Packaging:

- Please contact Customer Service for packaging and color options

CATALOG NUMBER	NO. OF PAIRS	AWG SIZE	COND. STRAND	NOM. INSULATION THICKNESS		NOM. JACKET THICKNESS		NOMINAL O.D.		NOM. C-C CAP.* pF/ft
				INCHES	mm	INCHES	mm	INCHES	mm	
C4008A	1	22	Solid	0.010	0.25	0.032	0.81	0.156	3.94	24.5
C4010A	2	22	Solid	0.010	0.25	0.032	0.81	0.218	5.54	24.5
C4014A	3	22	Solid	0.010	0.25	0.032	0.81	0.229	5.82	24.5
C4015A	4	22	Solid	0.010	0.25	0.032	0.81	0.249	6.32	24.5
C4017A	6	22	Solid	0.010	0.30	0.032	0.81	0.288	7.44	24.5
C6010A	2	22	7/30	0.010	0.25	0.032	0.81	0.228	5.79	24.5
C6014A	3	22	7/30	0.010	0.25	0.032	0.81	0.240	6.10	24.5
C6015A	4	22	7/30	0.010	0.25	0.032	0.81	0.262	6.65	24.5
C6017A	6	22	7/30	0.010	0.25	0.032	0.81	0.300	7.62	24.5
C6019A	9	22	7/30	0.010	0.25	0.032	0.81	0.366	9.30	24.5
C6023A	12	22	7/30	0.010	0.25	0.032	0.81	0.410	10.40	24.5
C6026A	15	22	7/30	0.010	0.25	0.032	0.81	0.456	11.58	24.5

* Capacitance between conductors

**CSA or c(UL)

Data subject to change.

Color Code Chart

NO. OF PAIRS	COLOR	NO. OF PAIRS	COLOR
1	Black paired with Red	9	Red paired with Green
2	Black paired with White	10	Red paired with Blue
3	Black paired with Green	11	Red paired with Yellow
4	Black paired with Blue	12	Red paired with Brown
5	Black paired with Yellow	13	Red paired with Orange
6	Black paired with Brown	14	Green paired with White
7	Black paired with Orange	15	Green paired with Blue
8	Red paired with White		



Multi-Paired, Unshielded

UL 2464, NEC/CEC Type CMG UL/CSA**

Product Construction:

Conductor:

- 18 AWG fully annealed stranded tinned copper per ASTM B33
- Twisted pairs

Insulation:

- Premium-grade, color-coded S-R PVC
- Color code: See chart below

Jacket:

- PVC, gray
- Temperature range: -20°C to +80°C

Applications:

- Computers
- Industrial equipment
- Data transmission
- Control circuits
- Suitable for EIA RS-232 applications
- Suggested voltage rating: 300 volts

Compliances:

- NEC Article 800 Type CM (UL: 75°C)
- UL Style 2464 (UL: 80°C, 300 V)
- CSA CMG (CSA: 60°C)
- RoHS Compliant Directive 2011/65/EU
- Designed to meet UL 70,000 BTU Vertical Tray Flame Test
- Passes CSA CMG Flame Test

Packaging:

- Please contact Customer Service for packaging and color options

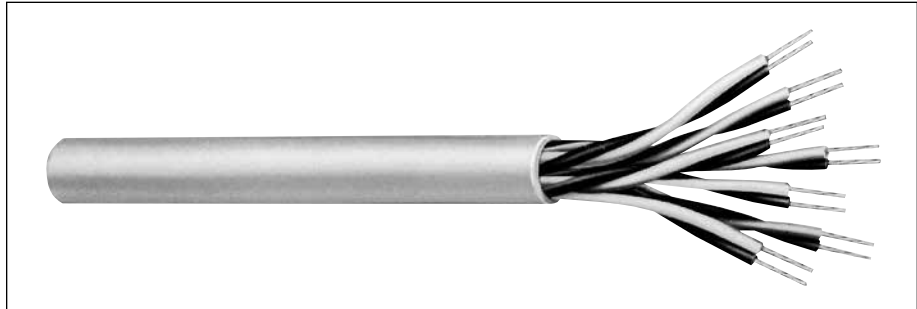

CATALOG NUMBER	NO. OF PAIRS	AWG SIZE	COND. STRAND	NOM. INSULATION THICKNESS		NOM. JACKET THICKNESS		NOMINAL O.D.		NOM. C-C CAP.* pF/ft
				INCHES	mm	INCHES	mm	INCHES	mm	
C6101A	1	18	16/30	0.013	0.33	0.032	0.81	0.206	5.23	26.3
C6118A	2	18	16/30	0.013	0.33	0.032	0.81	0.320	8.13	26.3
C6103A	3	18	16/30	0.013	0.33	0.032	0.81	0.338	8.59	26.3
C6119A	4	18	16/30	0.013	0.33	0.032	0.81	0.372	9.45	26.3
C6120A	5	18	16/30	0.013	0.33	0.032	0.81	0.408	10.36	26.3
C6106A	6	18	16/30	0.013	0.33	0.032	0.81	0.445	11.30	26.3
C6121A	8	18	16/30	0.013	0.33	0.032	0.81	0.484	12.29	26.3
C6109A	9	18	16/30	0.013	0.33	0.032	0.81	0.522	13.26	26.3
C6111A	15	18	16/30	0.013	0.33	0.032	0.81	0.659	16.74	26.3

*Capacitance between conductors

**CSA or c(UL)

Data subject to change.

Color Code Chart

NO. OF PAIRS	COLOR	NO. OF PAIRS	COLOR
1	Black paired with Red	9	Red paired with Green
2	Black paired with White	10	Red paired with Blue
3	Black paired with Green	11	Red paired with Yellow
4	Black paired with Blue	12	Red paired with Brown
5	Black paired with Yellow	13	Red paired with Orange
6	Black paired with Brown	14	Green paired with White
7	Black paired with Orange	15	Green paired with Blue
8	Red paired with White		

Multi-Paired, Unshielded

NEC Type CMP (UL) c(UL)



CATALOG NUMBER	NO. OF PAIRS	AWG SIZE	COND. STRAND	NOM. INSULATION THICKNESS		NOM. JACKET THICKNESS		NOMINAL O.D.		NOM. C-C CAP.* pF/ft
				INCHES	mm	INCHES	mm	INCHES	mm	
C8116	1	18	19/30	0.007	0.18	0.009	0.23	0.142	3.61	20.0
C8122	1	18	19/30	0.007	0.18	0.015	0.38	0.154	3.91	20.0

*Capacitance between conductors
Data subject to change.

Color Code Chart

NO. OF PAIRS	COLOR
1	Black and Red

Product Construction:

Conductor:

- 18 AWG fully annealed stranded tinned copper per ASTM B33
- Twisted pairs

Insulation:

- Premium-grade, color-coded FEP
- Color code: See chart below

Jacket:

C8116

- FEP, red
- Temperature range: -40°C to +200°C

C8122

- Flexguard® PVC, natural
- Temperature range: -20°C to +75°C

Applications:

- Audio systems
- Remote control circuits
- Process control and instrumentation
- Suggested voltage rating: 300 volts

Compliances:

- NEC Article 800
- Designed to meet NFPA 262 and CSA FT6 Steiner Tunnel Fire Tests for Plenum Applications

Packaging:

- Please contact Customer Service for packaging and color options



Designed to Meet
NFPA 262 and CSA FT6
Steiner Tunnel Fire Tests
for Plenum Applications

Underwriters Laboratories Inc.



Multi-Paired, Foil Shield

NEC/CEC Type CMG UL/CSA**

Product Construction:

Conductor:

- 22 AWG fully annealed solid or stranded tinned copper per ASTM B33
- Twisted pairs

Insulation:

- Premium-grade, color-coded S-R PVC
- Color code: See chart below

Shield:

- 100% Flexfoil® aluminum/polyester, 25% overlap, foil facing out
- Stranded tinned copper drain wire

Jacket:

- PVC, gray
- Temperature range: -20°C to +75°C

Applications:

- Audio systems
- Communication circuits
- Instrumentation and control use
- Suggested voltage rating: 300 volts

Compliances:

- NEC Article 800 Type CM (UL: 75°C, 300 V)
- CSA CMG (CSA: 60°C)
- RoHS Compliant Directive 2011/65/EU
- Designed to meet UL 70,000 BTU Vertical Tray Flame Test
- Passes CSA CMG Flame Test

Packaging:

- Please contact Customer Service for packaging and color options

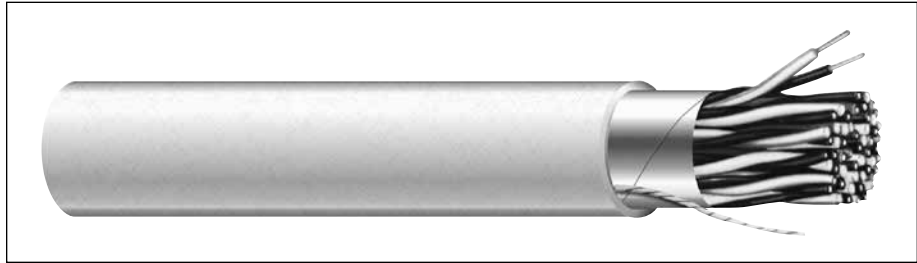

CATALOG NUMBER	NO. OF PAIRS	AWG SIZE	COND. STRAND	NOM. INSULATION THICKNESS		NOM. JACKET THICKNESS		NOMINAL O.D.		NOMINAL CAP.*	
				INCHES	mm	INCHES	mm	INCHES	mm	A	B
C7104A †	1	22	7/0096	0.013	0.33	0.035	0.89	0.185	4.70	35.0	62.0
C1670A	2	22	Solid	0.010	0.25	0.032	0.81	0.218	5.54	32.0	57.0
C1676A	4	22	Solid	0.010	0.25	0.032	0.81	0.249	6.32	28.0	50.0
C1671A	6	22	Solid	0.010	0.25	0.032	0.81	0.292	7.42	25.0	45.0
C1672A	9	22	Solid	0.010	0.25	0.032	0.81	0.338	8.59	25.0	45.0
C1673A	15	22	Solid	0.010	0.25	0.032	0.81	0.419	10.64	25.0	45.0

*A – Capacitance between conductors
 *B – Capacitance between one conductor and other conductors connected to shield
 † Also UL Style 2464 (UL: 80°C, 300 V)
 **CSA or c(UL)
 Data subject to change.

Color Code Chart

NO. OF PAIRS	COLOR	NO. OF PAIRS	COLOR
1	Black paired with Red	9	Red paired with Green
2	Black paired with White	10	Red paired with Blue
3	Black paired with Green	11	Red paired with Yellow
4	Black paired with Blue	12	Red paired with Brown
5	Black paired with Yellow	13	Red paired with Orange
6	Black paired with Brown	14	Green paired with White
7	Black paired with Orange	15	Green paired with Blue
8	Red paired with White		

Multi-Paired, Foil Shield

UL 2095, NEC Type CM (UL) c(UL)

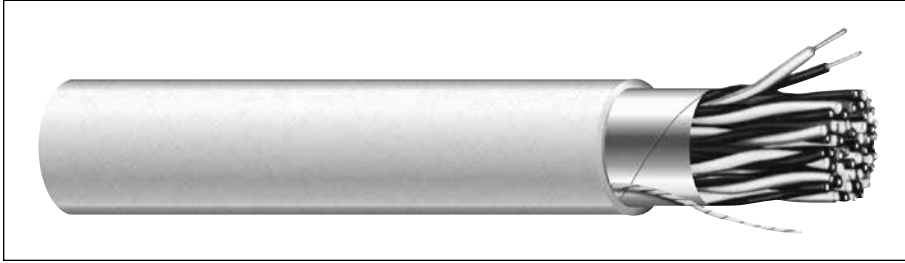

CATALOG NUMBER	NO. OF PAIRS	AWG SIZE	COND. STRAND	NOM. INSULATION THICKNESS		NOM. JACKET THICKNESS		NOMINAL O.D.		NOMINAL CAP.*	
				INCHES	mm	INCHES	mm	INCHES	mm	A	B
C6451A	51	22	Solid	0.010	0.25	0.050	1.27	0.715	18.16	25.0	45.0

*A – Capacitance between conductors

*B – Capacitance between one conductor and other conductors connected to shield

Data subject to change.

Color Code Chart

NO. OF PAIRS	COLOR	NO. OF PAIRS	COLOR	NO. OF PAIRS	COLOR
1	Blue paired with White	18	Brown/White striped paired with White	35	Green/White striped paired with Red
2	Orange paired with White				
3	Green paired with White	19	Brown/Gray striped paired with White	36	Green/Brown striped paired with Red
4	Brown paired with White				
5	Gray paired with White	20	Gray/White striped paired with White	37	Green/Gray striped paired with Red
6	Blue/White striped paired with White				
7	Blue/Orange striped paired with White	21	Blue paired with Red	38	Brown/White striped paired with Red
		22	Orange paired with Red		
8	Blue/Green striped paired with White	23	Green paired with Red	39	Brown/Gray striped paired with Red
		24	Brown paired with Red		
9	Blue/Brown striped paired with White	25	Gray paired with Red	40	Gray/White striped paired with Red
		26	Blue/White striped paired with Red		
10	Blue/Gray striped paired with White	27	Blue/Orange striped paired with Red	41	Blue paired with Black
				42	Orange paired with Black
11	Orange/White striped paired with White	28	Blue/Green striped paired with Red	43	Green paired with Black
				44	Brown paired with Black
12	Orange/Green striped paired with White	29	Blue/Brown striped paired with Red	45	Gray paired with Black
				46	Blue/White striped paired with Black
13	Orange/Brown striped paired with White	30	Blue/Gray striped paired with Red	47	Blue/Orange striped paired with Black
				48	Blue/Green striped paired with Black
14	Orange/Gray striped paired with White	31	Orange/White striped paired with Red	49	Blue/Brown striped paired with Black
				50	Blue/Gray striped paired with Black
15	Green/White striped paired with White	32	Orange/Green striped paired with Red	51	Orange/White striped paired with Black
16	Green/Brown striped paired with White	33	Orange/Brown striped paired with Red		
17	Green/Gray striped paired with White	34	Orange/Gray striped paired with Red		

Product Construction:

Conductor:

- 22 AWG fully annealed solid tinned copper per ASTM B33
- Twisted pairs

Insulation:

- Premium-grade, color-coded S-R PVC
- Color code: See chart below

Shield:

- 100% Flexfoil® aluminum/polyester, 25% overlap, foil facing out
- Stranded tinned copper drain wire

Jacket:

- PVC, gray
- Temperature range: -20°C to +80°C

Applications:

- Intercom systems
- Sound systems
- Electronic instrumentation control systems
- Suggested voltage rating: 300 volts

Compliances:

- NEC Article 800 Type CM (UL: 75°C, 300 V)
- UL Style 2095 (UL: 80°C, 300 V)
- RoHS Compliant Directive 2011/65/EU
- Designed to meet UL 70,000 BTU Vertical Tray Flame Test

Packaging:

- Please contact Customer Service for packaging and color options



Designed to Meet
UL Vertical Tray
Flame Test

Underwriters Laboratories Inc.



Multi-Paired, Foil Shield

NEC Type CMP (UL) c(UL)

Product Construction:

Conductor:

- 22 and 24 AWG fully annealed stranded tinned copper per ASTM B33
- Twisted pairs

Insulation:

- Premium-grade, color-coded fluoropolymer
- Color code: See chart below

Shield:

- 100% Flexfoil® aluminum/polyester foil with 25% overlap, minimum
- Stranded tinned copper drain wire

Jacket:

- Fluoropolymer, natural
- Water-resistant
- Temperature range: -40°C to +150°C
- Sequential footage marked to facilitate installation
- Includes ripcord

Applications:

- EIA RS-232 circuits
- Remote control circuits
- Process control and instrumentation
- Power-limited control circuits
- Suggested voltage rating: 300 volts

Compliances:

- NEC Article 800 (UL: 150°C, 300 V)
- Designed to meet NFPA 262 and CSA FT6 Steiner Tunnel Fire Tests for Plenum Applications

Packaging:

- Please contact Customer Service for packaging and color options

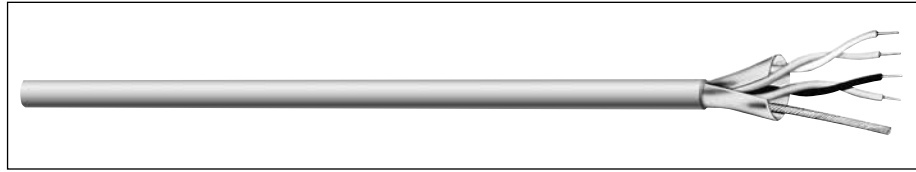

CATALOG NUMBER	NO. OF PAIRS	AWG SIZE	COND. STRAND	NOM. INSULATION THICKNESS		NOM. JACKET THICKNESS		NOMINAL O.D.		NOM. CAP.*	
				INCHES	mm	INCHES	mm	INCHES	mm	A	B
C3204	1	22	7/30	0.006	0.15	0.010	0.25	0.117	2.97	31.0	55.8
C3205	2	22	7/30	0.006	0.15	0.010	0.25	0.151	3.84	25.0	45.0
C3206	3	22	7/30	0.006	0.15	0.010	0.25	0.177	4.50	25.0	36.0
C3207	4	22	7/30	0.006	0.15	0.010	0.25	0.200	5.08	20.0	45.0
C3208	6	22	7/30	0.006	0.15	0.010	0.25	0.237	6.02	18.0	32.4
C3150	2	24	7/32	0.006	0.15	0.010	0.25	0.130	3.30	22.0	39.6
C3153	3	24	7/32	0.006	0.15	0.010	0.25	0.152	3.86	18.0	32.4
C3151	4	24	7/32	0.006	0.15	0.010	0.25	0.170	4.32	17.0	30.6
C3165	6	24	7/32	0.006	0.15	0.010	0.25	0.200	5.08	17.0	30.6
C3152	12.5	24	7/32	0.006	0.15	0.012	0.30	0.290	7.04	17.0	30.6

*A – Capacitance between conductors

*B – Capacitance between one conductor and other conductors connected to shield

Data subject to change.

Color Code Chart

NO. OF PAIRS	COLOR
1	Black & Yellow
2	Red & Purple
3	Dark Blue & Brown
4	Orange & Dark Green
5	Pink & Gray
6	Tan & White
7	Light Blue & Light Green
8	Red/White & White/Red
9	Orange/White & White/Orange
10	Yellow/White & White/Yellow
11	Gray/White & White/Gray
12	Blue/White & White/Blue
1C	Dark Green/Yellow

Multi-Paired, Foil Shield

NEC Type CMP (UL) c(UL)

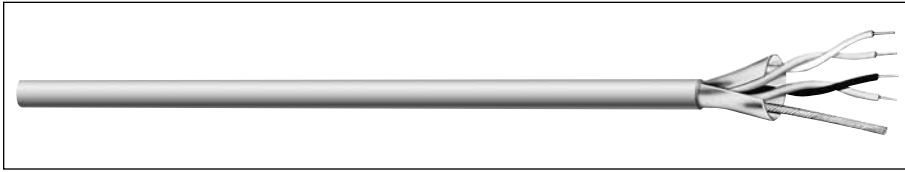

CATALOG NUMBER	NO. OF PAIRS	AWG SIZE	COND. STRAND	NOM. INSULATION THICKNESS		NOM. JACKET THICKNESS		NOMINAL O.D.		NOM. CAP.*	
				INCHES	mm	INCHES	mm	INCHES	mm	A	B
C8101**	1	18	19/30	0.007	0.18	0.016	0.41	0.165	4.19	51.0	95.0
C8104	1	18	19/30	0.007	0.18	0.016	0.41	0.165	4.19	51.0	95.0
C8103	1	22	7/30	0.006	0.15	0.014	0.36	0.120	3.05	35.0	65.0
C8109**	1	22	7/30	0.006	0.15	0.016	0.41	0.122	3.10	35.0	65.0

*A – Capacitance between conductors

*B – Capacitance between one conductor and other conductors connected to shield

** FEP jacket

Data subject to change.

Color Code Chart

NO. OF PAIRS	COLOR
1	Black and Red

Product Construction:

Conductor:

- 22 and 18 AWG fully annealed stranded tinned copper per ASTM B33
- Twisted pairs

Insulation:

- Premium-grade, color-coded FEP
- Color code: See chart below

Separator:

- Polyester tape with 25% overlap

Shield:

- 100% Flexfoil® aluminum/polyester foil with 25% overlap, minimum
- Stranded tinned copper drain wire

Jacket:

C8101, C8109

- FEP, red
- Temperature range: -100°C to +200°C

C8104, C8103

- PVDF, red
- Temperature range: -40°C to +150°C

Applications:

- Computer systems
- Remote control circuits
- Process control and instrumentation
- Suggested voltage rating: 300 volts

Compliances:

- NEC Article 800
- Designed to meet NFPA 262 and CSA FT6 Steiner Tunnel Fire Tests for Plenum Applications

Packaging:

- Please contact Customer Service for packaging and color options
- 1000' (305 m) reels



Designed to Meet
NFPA 262 and CSA FT6
Steiner Tunnel Fire Tests
for Plenum Applications

Underwriters Laboratories Inc.



Multi-Paired, Foil Shield

NEC Type CMP (UL) c(UL)

Product Construction:

Conductor:

- 24 AWG fully annealed stranded tinned copper per ASTM B33
- Twisted pairs

Insulation:

- Premium-grade, color-coded foam FEP
- Color code: See chart below

Core Wrap:

- Polyester tape with 25% overlap

Shield:

- 100% Flexfoil® aluminum/polyester foil with 25% overlap, minimum
- Stranded tinned copper drain wire

Jacket:

- PVDF, gray
- Temperature range: -40°C to +150°C

Applications:

- Computer systems
- Remote control circuits
- Process control and instrumentation
- Suitable for RS232, RS422, RS485
- Suggested voltage rating: 300 volts

Compliances:

- NEC Article 800
- Designed to meet NFPA 262 and CSA FT6 Steiner Tunnel Fire Tests for Plenum Applications

Packaging:

- Please contact Customer Service for packaging and color options

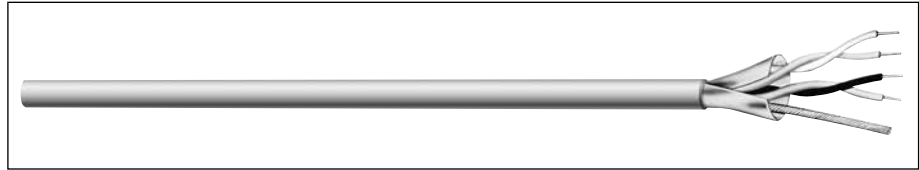

CATALOG NUMBER	NO. OF PAIRS	AWG SIZE	COND. STRAND	NOM. INSULATION THICKNESS		NOM. JACKET THICKNESS		NOMINAL O.D.		NOM. CAP.* pF/ft	
				INCHES	mm	INCHES	mm	INCHES	mm	A	B
C8118	2	24	7/32	0.014	0.15	0.015	0.38	0.203	5.16	12.0	22.0

*A – Capacitance between conductors

*B – Capacitance between one conductor and other conductors connected to shield
Data subject to change.

Color Code Chart

NO. OF PAIRS	COLOR
1	White/Blue paired with Blue/White
2	White/Orange paired with Orange/White

Multi-Paired, Foil Shield

NEC Type CMP (UL) c(UL)



CATALOG NUMBER	NO. OF PAIRS	AWG SIZE	COND. STRAND	NOM. INSULATION THICKNESS		NOM. JACKET THICKNESS		NOMINAL O.D.		NOM. CAP.*	
				INCHES	mm	INCHES	mm	INCHES	mm	A	B
C8127	1	24	7/32	0.006	0.15	0.014	0.36	0.108	2.69	30.0	60.0
C8113	3	24	7/32	0.006	0.15	0.014	0.36	0.161	4.09	25.0	45.0
C8126	1	22	7/30	0.006	0.15	0.014	0.36	0.120	3.05	35.0	65.0
C8123	1	18	19/30	0.007	0.18	0.014	0.36	0.160	4.06	51.0	90.0

*A – Capacitance between conductors

*B – Capacitance between one conductor and other conductors connected to shield

C8124**	1	22	7/30	0.007	0.18	0.017	0.43	0.128	3.25	32.0	62.0
----------------	---	----	------	-------	------	-------	------	-------	------	------	------

*A – Capacitance between conductors

*B – Capacitance between one conductor and other conductors connected to shield

**This item does not have a separator and has a shield fusible to the jacket to facilitate removal along with the jacket while stripping.

Data subject to change.

Color Code Chart

NO. OF PAIRS	COLOR
1	Black and Red

C8113 NO. OF PAIRS	COLOR
1	Black paired with White
2	Black paired with Red
3	Black paired with Green

Product Construction:

Conductor:

- 24, 22 and 18 AWG fully annealed stranded tinned copper per ASTM B33
- Twisted pairs

Insulation:

- Premium-grade, color-coded FEP
- Color code: See chart below

Core Wrap:

- Polyester tape with 25% overlap

Shield:

- 100% Flexfoil® aluminum/polyester foil with 25% overlap, minimum
- Stranded tinned copper drain wire

Jacket:

- Flexguard® PVC, natural
- Temperature range: -20°C to +75°C

Applications:

- Computer systems
- Remote control circuits
- Process control and instrumentation
- Suggested voltage rating: 300 volts

Compliances:

- NEC Article 800
- Designed to meet NFPA 262 and CSA FT6 Steiner Tunnel Fire Tests for Plenum Applications

Packaging:

- Please contact Customer Service for packaging and color options

Multi-Paired, Foil Shield

NEC Type CMP (UL) c(UL) and/or CL2P

Product Construction:

Conductor:

- 22 and 18 AWG fully annealed stranded tinned copper per ASTM B33 or stranded bare copper per ASTM B3
- Twisted pairs

Insulation:

- Premium-grade, color-coded Halar
- Color code: See chart below

Shield:

- 100% Flexfoil® aluminum/polyester foil with 25% overlap, minimum
- Stranded tinned copper drain wire

Jacket:

- PVDF, natural
- Temperature range: -10°C to +150°C
- Sequential footage marked to facilitate installation
- Includes ripcord

Applications:

- EIA RS-232 circuits
- Remote control circuits
- Process control and instrumentation
- Power-limited control circuits
- Suggested voltage rating: 150 volts

Compliances:

- NEC Article 800 (UL: 150°C, 300 V)
- NEC Article 725 (UL: 150°C, 150 V)
- Designed to meet NFPA 262 and CSA FT6 Steiner Tunnel Fire Tests for Plenum Applications

Features:

- Abrasion-, chemical- and water-resistant jacket

Packaging:

- Please contact Customer Service for packaging and color options

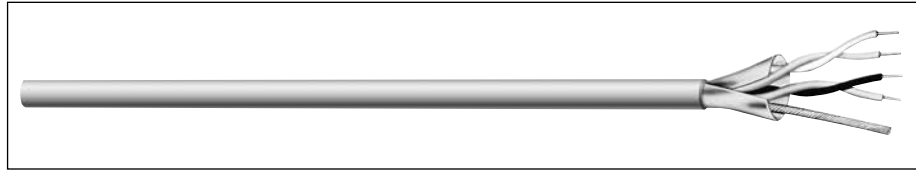

CATALOG NUMBER	NO. OF PAIRS	AWG SIZE	COND. STRAND	NOM. INSULATION THICKNESS		NOM. JACKET THICKNESS		NOMINAL O.D.		NOM. CAP.*	
				INCHES	mm	INCHES	mm	INCHES	mm	A	B

22 AWG, CL2P, c(UL) 150 VOLTS

C3352	2	22	7/30 TC	0.007	0.180	0.010	0.25	0.157	3.99	37.0	66.0
C3353	3	22	7/30 TC	0.007	0.180	0.010	0.25	0.194	4.42	30.0	53.0
C3354	4	22	7/30 TC	0.007	0.180	0.010	0.25	0.207	4.75	30.0	53.0
C3356	6	22	7/30 TC	0.007	0.180	0.010	0.25	0.246	5.74	27.0	48.0

18 AWG, CL2P/CMP, c(UL) 150 VOLTS

C3362	2	18	7/26 BC	0.008	0.020	0.010	0.25	0.205	5.21	44.0	79.0
C3364	4	18	7/26 BC	0.008	0.020	0.010	0.25	0.277	7.04	33.0	59.0

*A – Capacitance between conductors
 *B – Capacitance between one conductor and other conductors connected to shield
 Data subject to change.

Color Code Chart

NO. OF PAIRS	COLOR
1	Black & Yellow
2	Red & Purple
3	Dark Blue & Brown
4	Orange & Dark Green
5	Pink & Gray
6	Tan & White

Multi-Paired, Foil Shield

AWM Style 2464, CSA Type AWM I/II A/B, NEC/CEC Type CMG (CSA C/US)

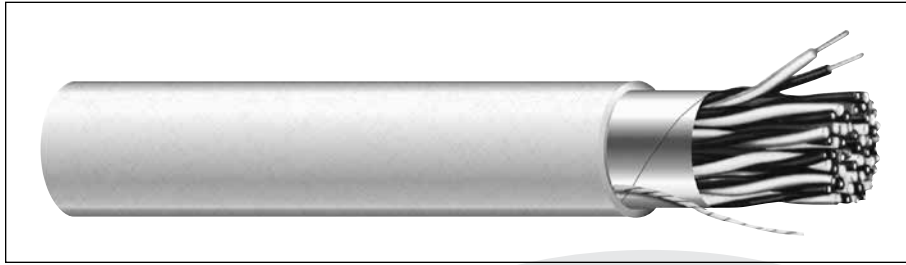

Product Construction:

Conductor:

- 24 AWG fully annealed stranded tinned copper per ASTM B33
- Twisted pairs

Insulation:

- Premium-grade, color-coded PVC
- Color code: See chart below

Shield:

- 100% Flexfoil® aluminum/polyester, 25% overlap, foil facing out
- Stranded tinned copper drain wire

Jacket:

- PVC, gray
- Temperature range: -20°C to +105°C

Applications:

- Computers
- Industrial equipment
- Data transmission
- Control circuits
- Suitable for EIA RS-232 applications
- Suggested voltage rating: 300 or 600 volts

Features:

- Excellent electrical properties
- Superior shielding effectiveness
- 25% shield overlap provides excellent shielding efficiency
- Assists system designers in meeting FCC Docket 20780 demands
- Good flexibility

Compliances:

- AWM Style 2464 (UL: 80°C, 300 V)
- CSA Type AWM (105°C, 600 V)
- CSA Certified CMG to harmonized standard UL 444 and CSA 22.2 No. 214
- NEC/CEC Type CMG (CSA: 105°C, 300 V)
- RoHS Compliant Directive 2011/65/EU
- Designed to meet CSA 70,000 BTU Vertical Tray Flame Test
- Passes CSA FT4 Vertical Flame Test

Packaging:

- Please contact Customer Service for packaging and color options

CATALOG NUMBER	NO. OF PAIRS	AWG SIZE	COND. STRAND	NOM. INSULATION THICKNESS		NOM. JACKET THICKNESS		NOMINAL O.D.		NOMINAL DCR		COLOR CODE	NOM. CAP.*	
				INCHES	mm	INCHES	mm	INCHES	mm	COND.	SHLD.		A	B
C4170A	1	24	7/32	0.011	0.28	0.032	0.81	0.160	4.06	26.0	18.0	1	36.4	65.5
C4209A	1	24	7/32	0.011	0.28	0.032	0.81	0.160	4.06	26.0	18.0	Wht/Blk	36.4	65.5
C4191A	1	24	7/32	0.011	0.28	0.030	0.76	0.160	4.06	26.0	16.5	Blk/Red	43.0	78.0
C4171A	2	24	7/32	0.011	0.28	0.032	0.81	0.214	5.44	26.0	18.0	1	31.9	57.3
C4172A	3	24	7/32	0.011	0.28	0.032	0.81	0.225	5.72	26.0	16.5	1	28.6	51.4
C4173A	4	24	7/32	0.011	0.28	0.032	0.81	0.245	6.22	26.0	16.5	1	28.6	51.4
C4174A	5	24	7/32	0.011	0.28	0.032	0.81	0.275	6.99	26.0	16.5	1	28.6	51.4
C4175A	6	24	7/32	0.011	0.28	0.032	0.81	0.300	7.62	26.0	15.2	1	26.3	47.5
C4176A	7	24	7/32	0.011	0.28	0.032	0.81	0.300	7.62	26.0	15.2	1	26.3	47.5
C4177A	8	24	7/32	0.011	0.28	0.032	0.81	0.320	8.13	26.0	15.0	1	26.3	47.5
C4178A	9	24	7/32	0.011	0.28	0.032	0.81	0.345	8.76	26.0	15.0	1	26.3	47.5
C4179A	10	24	7/32	0.011	0.28	0.032	0.81	0.375	9.53	26.0	14.0	1	26.3	47.5
C4180A	15	24	7/32	0.011	0.28	0.032	0.81	0.428	10.87	26.0	13.8	1	26.3	47.5
C4181A	19	24	7/32	0.011	0.28	0.032	0.81	0.450	11.43	26.0	13.5	1	26.3	47.5
C4182A	25	24	7/32	0.011	0.28	0.032	0.81	0.530	13.46	26.0	12.7	1	26.3	47.5

*A - Capacitance between conductors

*B - Capacitance between one conductor and other conductors connected to shield

Data subject to change.

Color Code Chart 1

NO. OF PAIRS	COLOR	NO. OF PAIRS	COLOR
1	Black with Red	14	Green with White
2	Black with White	15	Green with Blue
3	Black with Green	16	Green with Yellow
4	Black with Blue	17	Green with Brown
5	Black with Yellow	18	Green with Orange
6	Black with Brown	19	White with Blue
7	Black with Orange	20	White with Yellow
8	Red with White	21	White with Brown
9	Red with Green	22	White with Orange
10	Red with Blue	23	Blue with Yellow
11	Red with Yellow	24	Blue with Brown
12	Red with Brown	25	Blue with Orange
13	Red with Orange		



Multi-Paired, Foil Shield

AWM Style 2464, CSA Type AWM I/II A/B, NEC/CEC Type CMG (CSA C/US)

Product Construction:

Conductor:

- 22 AWG fully annealed stranded tinned copper per ASTM B33
- Twisted pairs

Insulation:

- Premium-grade, color-coded PVC
- Color code: See chart below

Shield:

- 100% Flexfoil® aluminum/polyester, 25% overlap, foil facing out
- Stranded tinned copper drain wire

Jacket:

- PVC, gray
- Temperature range: -20°C to +105°C

Applications:

- Computers
- Industrial equipment
- Data transmission
- Control circuits
- Suitable for EIA RS-232 applications
- Suggested voltage ratings: 300 or 600 volts

Features:

- Excellent electrical properties
- Superior shielding effectiveness
- 25% shield overlap provides excellent shielding efficiency
- Assists system designers in meeting FCC Docket 20780 demands
- Good flexibility

Compliances:

- AWM Style 2464 (UL: 80°C, 300 V)
- CSA Type AWM (105°C, 600 V)
- CSA Certified CMG to harmonized standard UL 444 and CSA 22.2 No. 214
- NEC/CEC Type CMG (CSA: 105°C, 300 V)
- RoHS Compliant Directive 2011/65/EU
- Designed to meet CSA 70,000 BTU Vertical Tray Flame Test
- Passes CSA FT4 Vertical Flame Test

Packaging:

- Please contact Customer Service for packaging and color options

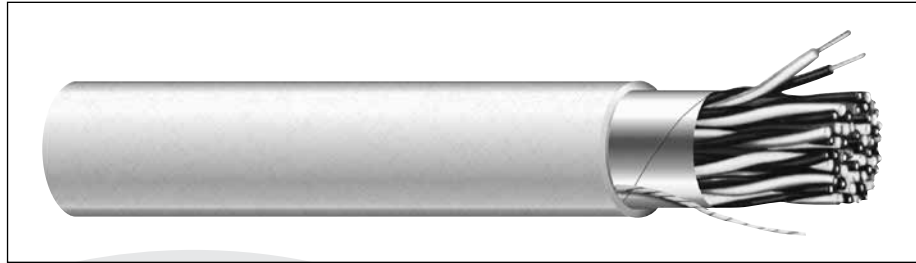

CATALOG NUMBER	NO. OF PAIRS	AWG SIZE	COND. STRAND	NOMINAL INSULATION THICKNESS		NOMINAL JACKET THICKNESS		NOMINAL O.D.		NOMINAL DCR Ω/kft		NOMINAL CAP.* pF/ft	
				INCHES	mm	INCHES	mm	INCHES	mm	COND.	SHLD.	A	B
C4183A	1	22	7/30	0.011	0.28	0.032	0.81	0.169	4.29	15.0	18.0	44.8	80.7
C4184A	2	22	7/30	0.011	0.28	0.032	0.81	0.234	5.94	15.0	16.5	35.9	64.6
C4185A	3	22	7/30	0.011	0.28	0.032	0.81	0.246	6.25	15.0	16.5	30.9	55.7
C4186A	4	22	7/30	0.011	0.28	0.032	0.81	0.269	6.83	15.0	16.5	30.9	55.7
C4187A	5	22	7/30	0.011	0.28	0.032	0.81	0.294	7.47	15.0	16.5	30.9	55.7
C4188A	6	22	7/30	0.011	0.28	0.032	0.81	0.320	8.13	15.0	16.5	28.4	51.0
C4189A	9	22	7/30	0.011	0.28	0.032	0.81	0.367	9.32	15.0	16.5	28.4	51.0
C4190A	15	22	7/30	0.011	0.28	0.032	0.81	0.457	11.61	15.0	16.5	28.4	51.0

*A – Capacitance between conductors

*B – Capacitance between one conductor and other conductors connected to shield
Data subject to change.

Color Code Chart 1

NO. OF PAIRS	COLOR	NO. OF PAIRS	COLOR
1	Black with Red	9	Red with Green
2	Black with White	10	Red with Blue
3	Black with Green	11	Red with Yellow
4	Black with Blue	12	Red with Brown
5	Black with Yellow	13	Red with Orange
6	Black with Brown	14	Green with White
7	Black with Orange	15	Green with Blue
8	Red with White		

Multi-Paired, Foil Shield, Mid-Cap

NEC Type CMP (UL) c(UL)

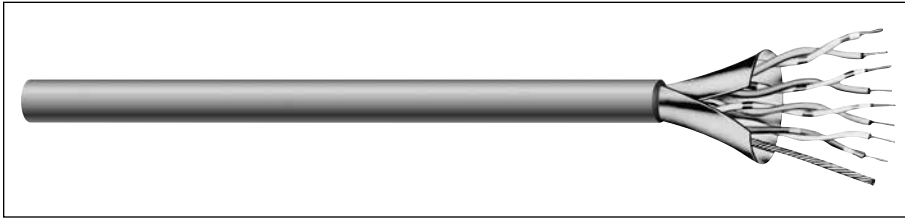

CATALOG NUMBER	NO. OF PAIRS	AWG SIZE	COND. STRAND	NOM. INSULATION THICKNESS		NOM. JACKET THICKNESS		NOMINAL O.D.		NOM. CAP.*	
				INCHES	mm	INCHES	mm	INCHES	mm	A	B
C3214	2	24	7/32	0.010	0.25	0.010	0.25	0.150	3.81	17.0	30.0
C3215	3	24	7/32	0.010	0.25	0.010	0.25	0.177	4.50	15.0	27.0
C3216	4	24	7/32	0.010	0.25	0.010	0.25	0.201	5.11	15.0	27.0
C3217	4.5	24	7/32	0.010	0.25	0.010	0.25	0.214	5.18	15.0	27.0
C3218	6	24	7/32	0.010	0.25	0.010	0.25	0.239	6.07	14.0	25.0

*A – Capacitance between conductors

*B – Capacitance between one conductor and other conductors connected to shield

Data subject to change.

Color Code Chart

NO. OF PAIRS	COLOR
1	Black paired with Yellow
2	Red paired with Purple
3	Dark Blue paired with Brown
4	Orange paired with Dark Green
5	Pink paired with Gray
6	Tan paired with White
1C	Green with Yellow Stripe

Product Construction:

Conductor:

- 24 AWG fully annealed stranded tinned copper per ASTM B33
- Twisted pairs

Insulation:

- Premium-grade, color-coded fluoropolymer
- Color code: See chart below

Shield:

- 100% Flexfoil® aluminum/polyester foil with 25% overlap, minimum
- Stranded tinned copper drain wire

Jacket:

- Fluoropolymer, natural
- Temperature range: -40°C to +150°C
- Sequential footage marked to facilitate installation
- Includes ripcord

Applications:

- EIA RS-232 and RS-422 circuits
- Remote control circuits
- Process control and instrumentation
- Power-limited control circuits
- Suggested voltage rating: 300 volts

Compliances:

- NEC Article 800 (UL: 150°C, 300 V)
- Designed to meet NFPA 262 and CSA FT6 Steiner Tunnel Fire Tests for Plenum Applications

Features:

- Abrasion-, chemical- and water-resistant jacket

Packaging:

- Please contact Customer Service for packaging and color options



Designed to Meet
NFPA 262 and CSA FT6
Steiner Tunnel Fire Tests
for Plenum Applications

Underwriters Laboratories Inc.



Multi-Paired, Foil Shield, Lo-Cap®

NEC Type CMP (UL) c(UL)

Product Construction:

Conductor:

- 24 AWG fully annealed stranded tinned copper per ASTM B33
- Twisted pairs

Insulation:

- Premium-grade, color-coded fluoropolymer
- Color code: See chart below

Shield:

- 100% Flexfoil® aluminum/polyester foil with 25% overlap, minimum
- Stranded tinned copper drain wire

Jacket:

- Fluoropolymer, natural
- Abrasion-, chemical- and water-resistant
- Temperature range: -40°C to +150°C
- Sequential footage marked to facilitate installation
- Includes ripcord

Applications:

- EIA RS-232 and RS-422 circuits
- Remote control circuits
- Process control and instrumentation
- Low capacitance requirements
- Suggested voltage rating: 300 volts

Compliances:

- NEC Article 800 (UL: 150°C, 300 V)
- Designed to meet NFPA 262 and CSA FT6 Steiner Tunnel Fire Tests for Plenum Applications

Packaging:

- Please contact Customer Service for packaging and color options

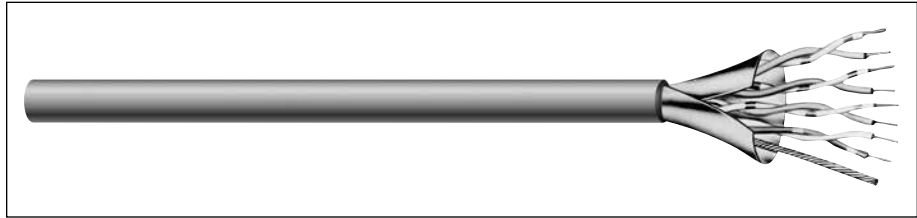

CATALOG NUMBER	NO. OF PAIRS	AWG SIZE	COND. STRAND	NOM. JACKET THICKNESS		NOMINAL O.D.		NOM. CAP.* pF/ft		IMPED. Ω NOM
				INCHES	mm	INCHES	mm	A	B	
C3028	2	24	7/32	0.010	0.25	0.159	4.04	15.0	27.00	94.0
C3029	3	24	7/32	0.010	0.25	0.183	4.65	14.0	25.00	107.0
C3030	4	24	7/32	0.010	0.25	0.246	6.25	14.0	25.00	107.0
C3031	6	24	7/32	0.012	0.30	0.285	7.24	13.0	23.00	115.0

*A – Capacitance between conductors

*B – Capacitance between one conductor and other conductors connected to shield
Data subject to change.

Color Code Chart

NO. OF PAIRS	COLOR
1	Black paired with Yellow
2	Red paired with Purple
3	Dark Blue paired with Brown
4	Orange paired with Dark Green
5	Pink paired with Gray
6	Tan paired with White

Multi-Paired, Overall Foil & TC Braid Shield, Lo-Cap®

NEC Type CMP (UL) c(UL)

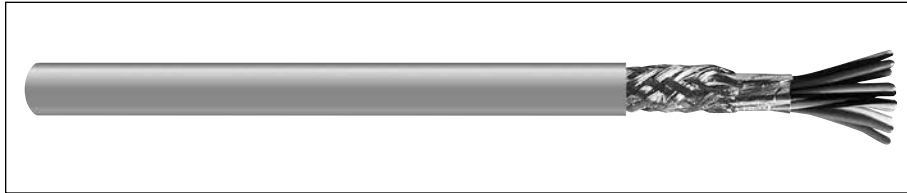

CATALOG NUMBER	NO. OF PAIRS	AWG SIZE	COND. STRAND	NOM. INSULATION THICKNESS		NOM. JACKET THICKNESS		NOMINAL O.D.		NOM. CAP.* pF/ft	
				INCHES	mm	INCHES	mm	INCHES	mm	A	B
C8117	1	24	7/32	0.026	0.66	0.014	0.36	0.208	5.28	12.0	22.0
C8129	2	24	7/32	0.019	0.48	0.017	0.43	0.280	6.93	12.0	22.0

*A – Capacitance between conductors

*B – Capacitance between one conductor and other conductors connected to shield

Data subject to change.

Color Code Chart

C8117 NO. OF PAIRS	COLOR
1	White/Blue paired with Blue/White

C8129 NO. OF PAIRS	COLOR
1	White/Blue paired with Blue/White
2	White/Orange paired with Orange/White

Product Construction:

Conductor:

- 24 AWG fully annealed stranded tinned copper per ASTM B33
- Twisted pairs

Insulation:

- Premium-grade, color-coded foam FEP
- Color code: See chart below

Shield:

- 100% Flexfoil® aluminum/polyester foil with 25% overlap, minimum
- 90% tinned copper braid

Jacket:

C8117

- FEP, red
- Temperature range: -100°C to +200°C

C8129

- Flexguard® PVC, natural
- Temperature range: -20°C to +75°C

Applications:

- Computer systems
- Remote control circuits
- Process control and instrumentation
- Suggested voltage rating: 300 volts

Compliances:

- NEC Article 800
- Designed to meet NFPA 262 and CSA FT6 Steiner Tunnel Fire Tests for Plenum Applications

Packaging:

- Please contact Customer Service for packaging and color options



Designed to Meet
NFPA 262 and CSA FT6
Steiner Tunnel Fire Tests
for Plenum Applications

Underwriters Laboratories Inc.



Multi-Paired, Individually Shielded

UL 2717, UL 2835, NEC Type CM (UL) c(UL) CMH or CMG

Product Construction:

Conductor:

- 22 AWG fully annealed stranded tinned copper per ASTM B33
- Twisted pairs

Insulation:

- Premium-grade, color-coded polypropylene
- Color code: See chart below

Shield:

- Individually shielded pairs
- 100% Flexfoil® aluminum/polyester, 25% overlap, foil facing out
- Stranded tinned copper drain wire

Jacket:

- PVC, gray
- Temperature range: -20°C to +80°C

Applications:

- Where total isolation of signal is required
- Computers
- Control circuits
- Industrial equipment
- Suggested voltage rating: 300 volts

Compliances:

- NEC Article 800 Type CM (UL: 75°C, 300 V)
- UL Style 2717 (UL: 80°C)
- UL Style 2835 (UL: 60°C, 30 V)
- UL Style 2464 (UL: 80°C, 300 V)
- CSA CMH (CSA: 60°C)
- CSA CMG (CSA: 60°C)
- RoHS Compliant Directive 2011/65/EU
- Designed to meet CSA 70,000 BTU Vertical Tray Flame Test
- Passes CSA CMH or CMG Flame Test

Packaging:

- Please contact Customer Service for packaging and color options

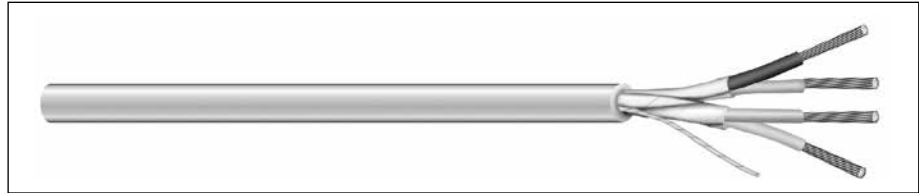

CATALOG NUMBER	NO. OF PAIRS	AWG SIZE	COND. STRAND	NOM. INSULATION THICKNESS		NOM. JACKET THICKNESS		NOMINAL O.D.		NOMINAL CAP.*	
				INCHES	mm	INCHES	mm	INCHES	mm	A	B
POLYPROPYLENE INSULATION – NEC TYPE CM(UL) c(UL) CMH											
C1352A	2	22	7/30	0.007	0.18	0.020	0.51	0.160	4.06	30.0	45.0
POLYPROPYLENE INSULATION – UL STYLE 2717, UL STYLE 2835, CM(UL) c(UL) CMH											
C1353A**	2	22	7/30	0.010	0.25	0.028	0.71	0.208	5.028	25.0	53.5
SR-PVC INSULATION – UL STYLE 2464, CM(UL) c(UL) CMG											
C7106A	2	20	7/28	0.010	0.25	0.041	1.04	0.305	7.75	46.0	82.0

*A – Capacitance between conductors
 *B – Capacitance between one conductor and other conductors connected to shield
 **Individually shielded with overall shield
 Data subject to change.

Color Code Chart

NO. OF PAIRS	COLOR
1	Black/Red
2	Green/White

Multi-Paired, Individually Shielded

CSA Type AWM I/II A/B, NEC/CEC Type CMG (CSA C/US)

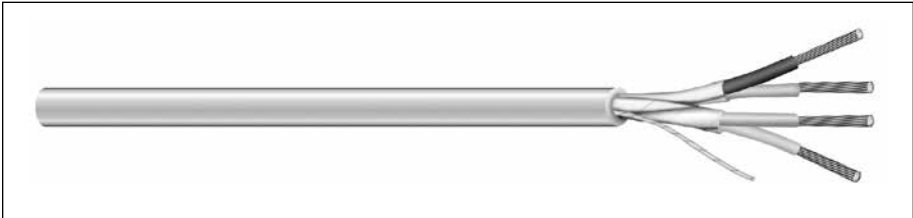

Product Construction:

Conductor:

- 22 AWG fully annealed stranded tinned copper per ASTM B33
- Twisted pairs

Insulation:

- Premium-grade, color-coded PVC
- Color code: See chart below

Shield:

- Individually shielded pairs
- 100% Flexfoil® aluminum/polyester, 25% overlap, foil facing out
- Stranded tinned copper drain wire

Jacket:

- PVC, gray
- Temperature range: -20°C to +105°C

Applications:

- Where total isolation of signal is required
- Computers
- Control circuits
- Industrial equipment
- Suggested voltage rating: 300 or 600 volts

Compliances:

- CSA Type AWM (105°C, 600 V)
- CSA Certified CMG to harmonized standard UL 444 and CSA (22.2 No. 2)
- NEC/CEC Type CMG (CSA: 105°C, 300 V)
- RoHS Compliant Directive 2011/65/EU
- Designed to meet CSA 70,000 BTU Vertical Tray Flame Test
- Passes CSA FT4 Vertical Flame Test

Packaging:

- Please contact Customer Service for packaging and color options

CATALOG NUMBER	NO. OF PAIRS	AWG SIZE	COND. STRAND	NOMINAL INSULATION THICKNESS		NOMINAL JACKET THICKNESS		NOMINAL O.D.		NOMINAL DCR Ω/kft		NOMINAL CAP* pF/ft	
				INCHES	mm	INCHES	mm	INCHES	mm	COND.	SHLD.	A	B
C4203A	2	22	7/30	0.011	0.28	0.020	0.51	0.175	4.45	16.6	7.2	67.0	121.0

*A – Capacitance between conductors

*B – Capacitance between one conductor and other conductors connected to shield
Data subject to change.

Color Code Chart

NO. OF PAIRS	COLOR
1	Black with Red
2	Green with White



Multi-Paired, Individually Shielded

UL 2464, UL 2576, NEC/CEC Type CMR, CMG UL/CSA†

Product Construction:

Conductor:

- 22 AWG fully annealed stranded tinned copper per ASTM B33
- Twisted pairs

Insulation:

- Premium-grade, color-coded S-R PVC per UL AWM Style 1061
- Color code: See chart below

Shield:

- Individually shielded pairs
- 100% Flexfoil® aluminum/polyester, 25% overlap, foil facing in
- Stranded tinned copper drain wire

Jacket:

- PVC, beige
- Temperature range: -20°C to +80°C

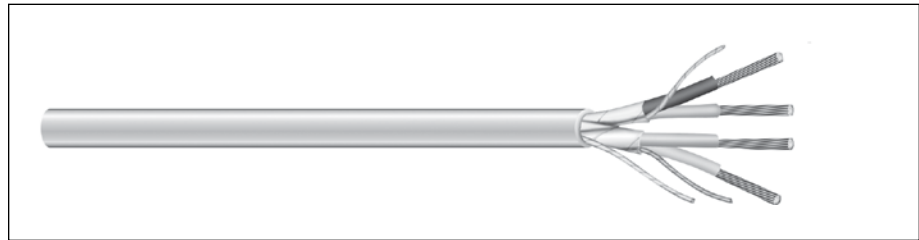

CATALOG NUMBER	NO. OF PAIRS	AWG SIZE	COND. STRAND	NOM. INSULATION THICKNESS		NOM. JACKET THICKNESS		NOMINAL O.D.		NOMINAL CAP.*	
				INCHES	mm	INCHES	mm	INCHES	mm	A	B
C1350A	2	22	7/30	0.010	0.25	0.035	0.889	0.175 x 0.280	4.45 x 7.11	40	71.5

*A – Capacitance between conductors

*B – Capacitance between one conductor and other conductors connected to shield

†CSA or c(UL)

Data subject to change.

Applications:

- Computer interconnections
- Data transmission
- Control circuits
- Industrial equipment control
- Suggested voltage rating: 300 volts

Compliances:

- NEC Article 800 Type CMR (UL: 75°C)
- UL Style 2464 (UL: 80°C, 300 V)
- UL Style 2576
- CSA CMG (CSA: 60°C)
- RoHS Compliant Directive 2011/65/EU
- Designed to meet UL 70,000 BTU Vertical Tray Flame Test
- Passes CSA CMG Flame Test

Packaging:

- Please contact Customer Service for packaging and color options

Color Code Chart

NO. OF PAIRS	COLOR
1	Black/White
2	Black/Yellow

Multi-Paired, Individually Foil Shielded

NEC Type CMP (UL) c(UL)

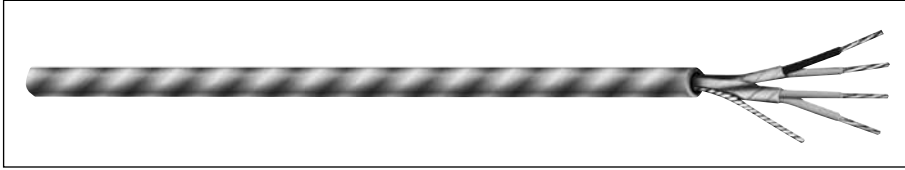

CATALOG NUMBER	NO. OF PAIRS	AWG SIZE	COND. STRAND	NOM. INSULATION THICKNESS		NOM. JACKET THICKNESS		NOMINAL O.D.		NOM. CAP.**	
				INCHES	mm	INCHES	mm	INCHES	mm	A	B
C3156*	2	22	7/30	0.006	0.15	0.010	0.25	0.147	3.73	35.0	63.0
C3157†	3	22	7/30	0.006	0.15	0.010	0.25	0.184	4.67	35.0	63.0

* Cabled on common axis to reduce diameter, foil out, common drain wire
 ** A – Capacitance between conductors
 ** B – Capacitance between one conductor and other conductors connected to shield
 † 3 individually shielded pairs with separate drain wires
 Data subject to change.

Color Code Chart

C3156 NO. OF PAIRS	COLOR
1	Black paired with Red
2	White paired with Green

C3157 NO. OF PAIRS	COLOR
1	Black paired with Red
2	Black paired with White
3	Black paired with Green

Product Construction:

Conductor:

- 22 AWG fully annealed stranded tinned copper per ASTM B33
- Twisted pairs

Insulation:

- Premium-grade, color-coded FEP
- Color code: See chart below

Shield:

- 100% Flexfoil® aluminum/polyester foil, each with 25% overlap, minimum
- Stranded tinned copper drain wire

Jacket:

- PVDF, red
- Abrasion-, chemical- and water-resistant
- Temperature range: -40°C to +150°C
- Sequential footage marked to facilitate installation
- Includes ripcord

Applications:

- Point of sale systems
- Remote control circuits
- Process control and instrumentation
- Power-limited control circuits
- Suggested voltage rating: 300 volts

Compliances:

- NEC Article 800 (UL: 150°C, 300 V)
- Designed to meet NFPA 262 and CSA FT6 Steiner Tunnel Fire Tests for Plenum Applications

Packaging:

- Please contact Customer Service for packaging and color options



Designed to Meet
 NFPA 262 and CSA FT6
 Steiner Tunnel Fire Tests
 for Plenum Applications

Underwriters Laboratories Inc.



Multi-Paired, Individually Foil Shielded

NEC Type CMP (UL) c(UL)

Product Construction:

Conductor:

- 24 thru 22 AWG fully annealed stranded tinned copper per ASTM B33
- Twisted pairs

Insulation:

- Premium-grade, color-coded FEP or foamed FEP
- Color code: See chart below

Pair Shield:

- 100% Flexfoil® aluminum/polyester foil, with 25% overlap, minimum
- Individually shielded pairs with stranded tinned copper drain wire

Jacket:

- Flexguard® PVC, natural
- Temperature range: -20°C to +75°C

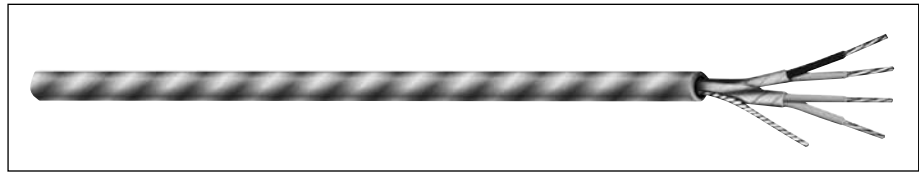

CATALOG NUMBER	NO. OF PAIRS	AWG SIZE	COND. STRAND	NOM. INSULATION THICKNESS		NOM. JACKET THICKNESS		NOMINAL O.D.		NOM. CAP.*	
				INCHES	mm	INCHES	mm	INCHES	mm	A	B
C8134	2	24	7/32	0.019	0.48	0.015	0.38	0.255	7.48	35.0	76.0
C8105	2	22	7/30	0.006	0.15	0.014	0.36	0.186	4.72	43.0	75.0
C8131	3	22	7/30	0.010	0.25	0.018	0.46	0.237	6.02	35.0	76.0
C8133	6	22	7/30	0.010	0.25	0.018	0.45	0.314	7.98	35.0	76.0

*A – Capacitance between conductors

*B – Capacitance between one conductor and other conductors connected to shield
Data subject to change.

Applications:

- Computer systems
- Remote control circuits
- Process control and instrumentation
- Suggested voltage rating: 300 volts

Compliances:

- NEC Article 800
- Designed to meet NFPA 262 and CSA FT6 Steiner Tunnel Fire Tests for Plenum Applications

Packaging:

- Please contact Customer Service for packaging and color options

Color Code Chart

C8105 NO. OF PAIRS	COLOR
1	Black paired with Red
2	White paired with Green

C8131 NO. OF PAIRS	COLOR
1	Black paired with Red
2	Black paired with White
3	Black paired with Green

C8133 NO. OF PAIRS	COLOR
1	Black paired with Red
2	Black paired with White
3	Black paired with Green
4	Black paired with Blue
5	Black paired with Yellow
6	Black paired with Brown

C8134 NO. OF PAIRS	COLOR
1	White/Blue paired with Blue/White
2	White/Orange paired with Orange/White

Multi-Paired, Individually Foil Shielded

NEC Type CMP (UL) c(UL)

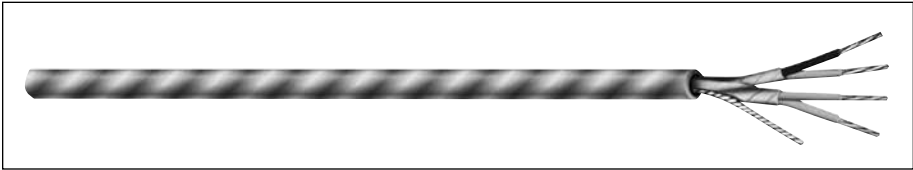

CATALOG NUMBER	NO. OF PAIRS	AWG SIZE	COND. STRAND	NOM. INSULATION THICKNESS		NOM. JACKET THICKNESS		NOMINAL O.D.		NOM. CAP.*	
				INCHES	mm	INCHES	mm	INCHES	mm	A	B
C8112	2	22	7/30	0.006	0.15	0.014	0.36	0.186	4.72	35.0	65.0
C8132	6	22	7/30	0.010	0.25	0.015	0.38	0.309	7.85	30.0	65.0

*A – Capacitance between conductors

*B – Capacitance between one conductor and other conductors connected to shield
Data subject to change.

Color Code Chart

C8112 NO. OF PAIRS	COLOR
1	Black paired with Red
2	White paired with Green

C8132 NO. OF PAIRS	COLOR
1	Black paired with Red
2	Black paired with White
3	Black paired with Green
4	Black paired with Blue
5	Black paired with Yellow
6	Black paired with Brown

Product Construction:

Conductor:

- 22 AWG fully annealed stranded tinned copper per ASTM B33
- Twisted pairs

Insulation:

- Premium-grade, color-coded FEP
- Color code: See chart below

Pair Shield:

- 100% Flexfoil® aluminum/polyester foil, with 25% overlap, minimum
- Individually shielded pairs with stranded tinned copper drain wire

Jacket:

- FEP, red
- Temperature range: -100°C to +200°C

Applications:

- Computer systems
- Remote control circuits
- Process control and instrumentation
- Suggested voltage rating: 300 volts

Compliances:

- NEC Article 800
- Designed to meet NFPA 262 and CSA FT6 Steiner Tunnel Fire Tests for Plenum Applications

Packaging:

- Please contact Customer Service for packaging and color options



Designed to Meet
NFPA 262 and CSA FT6
Steiner Tunnel Fire Tests
for Plenum Applications

Underwriters Laboratories Inc.



Multi-Paired, Individually Foil Shielded

NEC Type CMP (UL) c(UL)

Product Construction:

Conductor:

- 24 AWG fully annealed stranded tinned copper per ASTM B33
- Twisted pairs

Insulation:

- Premium-grade, color-coded foam FEP
- Color code: See chart below

Pair Shield:

- 100% Flexfoil® aluminum/polyester foil with 25% overlap, minimum
- Individually shielded pairs with stranded tinned copper drain wire

Jacket:

- PVDF, gray
- Temperature range: -40°C to +150°C

Applications:

- Computer systems
- Remote control circuits
- Process control and instrumentation
- Suggested voltage rating: 300 volts

Compliances:

- NEC Article 800
- Designed to meet NFPA 262 and CSA FT6 Steiner Tunnel Fire Tests for Plenum Applications

Packaging:

- Please contact Customer Service for packaging and color options

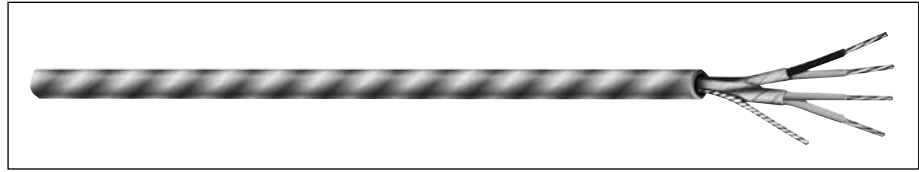

CATALOG NUMBER	NO. OF PAIRS	AWG SIZE	COND. STRAND	NOM. INSULATION THICKNESS		NOM. JACKET THICKNESS		NOMINAL O.D.		NOM. CAP.*	
				INCHES	mm	INCHES	mm	INCHES	mm	A	B
C8128	2	24	7/32	0.019	0.48	0.018	0.46	0.261	6.63	12.5	22.0

*A – Capacitance between conductors

*B – Capacitance between one conductor and other conductors connected to shield

Data subject to change.

Color Code Chart

NO. OF PAIRS	COLOR
1	White/Blue paired with Blue/White
2	White/Orange paired with Orange/White

Power-Limited Tray Cable, Individually Shielded

UL 2464, NEC Type PLTC and NEC/CEC Type CMG UL/CSA†

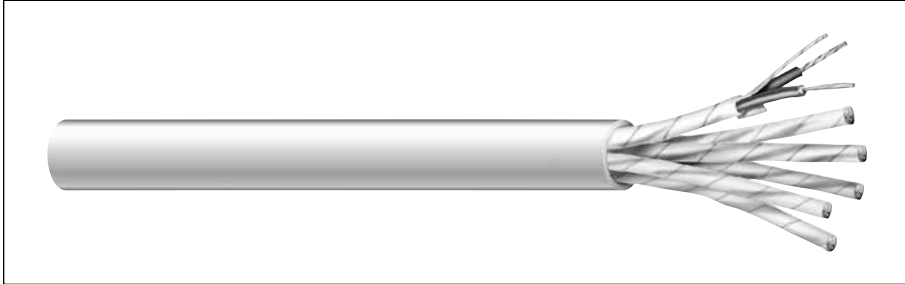

Product Construction:

Conductor:

- 22 or 18 AWG fully annealed stranded tinned copper per ASTM B33
- Twisted pairs

Insulation:

- Premium-grade, color-coded PVC
- Color code: Each pair black and red, numbered at one-inch intervals

Shield:

- Pairs are 100% individually shielded with Flexfoil® aluminum/polyester, foil facing in
- Stranded tinned copper drain wire each pair

Jacket:

- PVC, gray
- Sunlight-resistant
- Temperature range: -20°C to +105°C

Applications:

- Power-limited circuits
- Intercom systems
- Business machines
- Cash registers
- Computer interconnects
- Suitably marked for appropriate tray cable installations
- Burglar alarms
- Suggested voltage rating: 300 volts

Compliances:

- NEC Article 725 Power-Limited Tray Cable (UL: 105°C, 300 V)
- UL Style 2464 (UL: 80°C)
- CSA CMG (CSA: 60°C)
- RoHS Compliant Directive 2011/65/EU
- Designed to meet UL 70,000 BTU Vertical Tray Flame Test
- Passes CSA CMG Flame Test

Packaging:

- Please contact Customer Service for packaging and color options

CATALOG NUMBER	NO. OF PAIRS	AWG SIZE	COND. STRAND	NOM. INSULATION THICKNESS		NOM. JACKET THICKNESS		NOMINAL O.D.		NOMINAL CAP.*	
				INCHES	mm	INCHES	mm	INCHES	mm	A	B
C0570A	2	22	7/30	0.016	0.41	0.042	1.07	0.327	8.31	38.5	69.5
C0571A	3	22	7/30	0.016	0.41	0.042	1.07	0.345	8.76	38.5	69.5
C0572A	4	22	7/30	0.016	0.41	0.042	1.07	0.378	9.60	38.5	69.5
C0573A	6	22	7/30	0.016	0.41	0.053	1.35	0.469	11.91	38.5	69.5
C0574A	9	22	7/30	0.016	0.41	0.053	1.35	0.542	13.77	38.5	69.5
C0575A	11	22	7/30	0.016	0.41	0.053	1.35	0.589	14.96	38.5	69.5
C0584A	2	18	16/30	0.016	0.41	0.042	1.07	0.380	9.65	50.5	91.0
C0585A	3	18	16/30	0.016	0.41	0.053	1.35	0.437	11.10	50.5	91.0
C0586A	4	18	16/30	0.016	0.41	0.053	1.35	0.478	12.14	50.5	91.0
C0587A	6	18	16/30	0.016	0.41	0.053	1.35	0.566	14.38	50.5	91.0
C0588A	9	18	16/30	0.016	0.41	0.063	1.60	0.679	17.25	50.5	91.0
C0589A	11	18	16/30	0.016	0.41	0.063	1.60	0.738	18.75	50.5	91.0
C0590A	15	18	16/30	0.016	0.41	0.063	1.60	0.845	21.46	50.5	91.0

*A – Capacitance between conductors

*B – Capacitance between one conductor and other conductors connected to shield

†CSA or c(UL)

Data subject to change.

Color Code Chart

NO. OF PAIRS	COLOR
1 thru 15	Black Red

Each pair marked and numbered



Power-Limited Tray Cable, Foil Shield

UL 2464, NEC Type PLTC, NEC/CEC Type CM, CMG UL/CSA†

Product Construction:

Conductor:

- 22 or 18 AWG fully annealed stranded tinned copper per ASTM B33
- Twisted pairs

Insulation:

- Premium-grade, color-coded PVC or FMPE
- Color code: See chart below

Shield:

- 100% Flexfoil® aluminum/polyester, 25% overlap, foil facing out
- Stranded tinned copper drain wire
- 65% tinned copper braid (C7112A, C7114A and C7116A only)

Jacket:

- PVC, gray or black
- Sunlight-resistant
- Temperature range: -20°C to +60°C or +105°C

Applications:

- Power-limited circuits
- Intercom systems
- Business machines
- Computer interconnects
- Suitably marked for appropriate tray cable installations
- Petrochemical control systems
- Burglar alarms
- Suggested voltage rating: 300 volts

Compliances:

- NEC Article 725 Power-Limited Tray Cable (UL: 105°C or 60°C, 300 V)
- NEC Article 800 Communications Cable (UL: 105°C or 60°C, 300 V)
- †UL Style 2464 (UL: 80°C, 300 V)
- UL PTLC Listing
- CSA CMG (CSA: 60°C) or CM c(UL)
- RoHS Compliant Directive 2011/65/EU
- Designed to meet UL 70,000 BTU Vertical Tray Flame Test
- Passes CSA CMG Flame Test

Packaging:

- Please contact Customer Service for packaging and color options

† UL Style 2464 only available on PVC insulation constructions

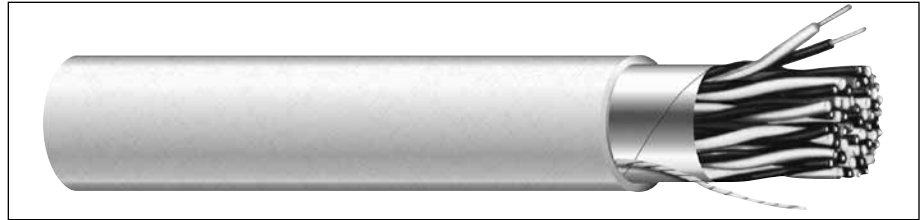

CATALOG NUMBER	NO. OF PAIRS	AWG SIZE	COND. STRAND	NOM. INSULATION THICKNESS		NOM. JACKET THICKNESS		NOMINAL O.D.		NOMINAL CAP.*	
				INCHES	mm	INCHES	mm	INCHES	mm	A	B
PVC INSULATION – UL STYLE 2464, NEC TYPE PLTC/CM, CSA CMG, 105°C											
C0550A	2	22	7/.0096	0.015	0.38	0.042	1.07	0.294	7.47	32.0	57.0
C0551A	3	22	7/.0096	0.015	0.38	0.042	1.07	0.309	7.85	29.0	52.2
C0552A	4	22	7/.0096	0.015	0.38	0.042	1.07	0.337	8.56	29.0	52.2
C0553A	6	22	7/.0096	0.015	0.38	0.042	1.35	0.418	10.62	26.5	47.7
C0554A	9	22	7/.0096	0.015	0.38	0.042	1.35	0.480	12.19	26.5	47.7
C0555A	11	22	7/30	0.015	0.38	0.053	1.35	0.520	13.21	27.0	48.5
C0556A	15	22	7/30	0.015	0.38	0.053	1.35	0.592	15.04	27.0	48.5
C0560A	2	18	16/30	0.016	0.41	0.042	1.07	0.314	7.98	40.0	72.0
C0561A	3	18	16/30	0.016	0.41	0.042	1.07	0.403	10.24	33.5	60.3
C0562A	4	18	16/30	0.016	0.41	0.042	1.07	0.440	11.18	33.5	60.3
C0563A	6	18	16/30	0.016	0.41	0.053	1.35	0.519	13.18	30.5	54.9
C0564A	9	18	16/30	0.016	0.41	0.063	1.60	0.643	16.33	30.5	54.9
C0566A	15	18	16/30	0.016	0.41	0.063	1.60	0.720	18.29	30.5	54.9

*A – Capacitance between conductors
 *B – Capacitance between one conductor and other conductors connected to shield
 †CSA or c(UL)
 Data subject to change.

Color Code Chart

NO. OF PAIRS	COLOR
1 thru 9	Black/Red

Each pair marked and numbered

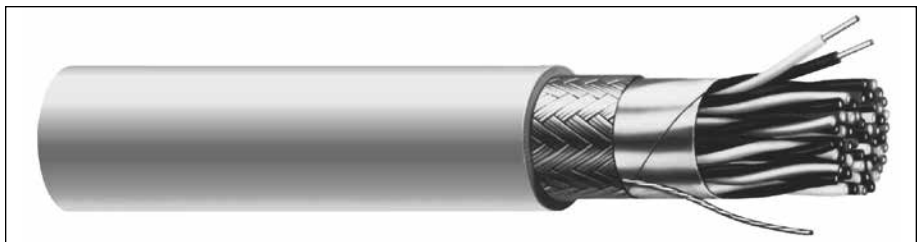

LO-CAP® DATACOM COLOR CODE WITH 65% TINNED COPPER BRAID

CATALOG NUMBER	NO. OF PAIRS	AWG SIZE	COND. STRAND	NOM. INSULATION THICKNESS		NOM. JACKET THICKNESS		NOMINAL O.D.		NOMINAL CAP.*	
				INCHES	mm	INCHES	mm	INCHES	mm	A	B
FOAMED POLYETHYLENE INSULATION – NEC TYPE PLTC/CM, CEC CM c(UL), 60°C											
C7112A	1	22	7/.0096	0.024	0.61	0.037	0.94	0.261	6.63	11.5	20.5
C7114A	2	22	7/.0096	0.017	0.43	0.042	1.07	0.343	8.71	11.0	19.6
C7116A	3	22	7/.0096	0.015	0.38	0.042	1.07	0.344	8.74	11.0	19.6

*A – Capacitance between conductors
 *B – Capacitance between one conductor and other conductors connected to shield
 Data subject to change.

Color Code Chart

NO. OF PAIRS	COLOR
1	White/Blue Stripe and Blue/White Stripe
2	White/Orange Stripe and Orange/White Stripe
3	White/Green Stripe and Green/White Stripe



Computer Cable



General Cable manufactures a comprehensive line of computer cables.

This complete line of paired and unpaired, shielded computer cables—which are UL and CSA listed—are used primarily for the internal or external interconnection of electronic equipment and computers. Applications include data transmission, CAD/CAM, telemetry, data displays, computer print-out, credit verification systems and similar applications.

General Cable also offers a variety of put-ups for computer cables to meet your individual requirements.

Our products are manufactured to meet the latest UL, CSA and NEC requirements and approvals.

Index	Page
Multi-Conductor, Foil Shield	63-64
Multi-Conductor, Foil/Braid Shield	65-66
Multi-Conductor, Foil/Braid Shield, Lo-Cap®	67
Multi-Paired, Foil Shield	68
Multi-Paired, Foil Shield, Lo-Cap	69
Multi-Paired, Foil/Braid Shield	70
Multi-Paired, Foil/Braid Shield, Lo-Cap	71-73
Multi-Paired, Individually Foil Shielded	74
Multi-Paired, Individually Foil Shielded, Lo-Cap	75
Multi-Paired, Individually Foil/Braid Shielded, Lo-Cap	76

Multi-Conductor, Foil Shield

UL 2464, NEC/CEC Type CMR, CMG UL/CSA

Product Construction:

Conductor:

- 24 AWG fully annealed stranded tinned copper per ASTM B33

Insulation:

- Premium-grade, color-coded S-R PVC per UL AWM Style 1061
- Color code: See charts below

Shield:

- 100% Flexfoi® aluminum/polyester with 25% overlap, foil facing out
- Stranded tinned copper drain wire

Jacket:

- PVC, gray
- Temperature range: -20°C to +80°C

Applications:

- Computer interconnections
- Data transmission
- Control circuits
- Industrial equipment control
- Suitable for EIA RS-232 applications
- Suggested voltage rating: 300 volts

Compliances:

- NEC Article 800 Type CMR (UL: 75°C)
- UL Style 2464 (UL: 80°C, 300 V)
- CSA CMG (CSA: 60°C)
- RoHS Compliant Directive 2011/65/EU
- Designed to meet UL 70,000 BTU Vertical Tray Flame Test
- Passes CSA CMG Flame Test
- CE: Low Voltage Directive (LVD) 2006/95/EC

Packaging:

- Please contact Customer Service for packaging and color options

Data subject to change.

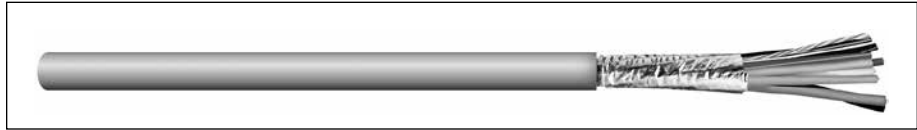

CATALOG NUMBER	NO. OF COND.	AWG SIZE	COND. STRAND	NOMINAL INSULATION THICKNESS		NOMINAL JACKET THICKNESS		NOMINAL O.D.		NOMINAL DCR Ω/kft @20°C		NOMINAL CAP.* pF/ft	
				INCHES	mm	INCHES	mm	INCHES	mm	COND.	SHLD.	A	B
C0740A	2	24	7/32	0.010	0.25	0.032	0.81	0.157	3.99	26.0	7.2	36.0	64.0
C0741A	3	24	7/32	0.010	0.25	0.032	0.81	0.164	4.17	26.0	7.2	33.0	59.0
C0742A	4	24	7/32	0.010	0.25	0.032	0.81	0.175	4.45	26.0	7.2	33.0	59.0
C0753A	5	24	7/32	0.010	0.25	0.032	0.81	0.188	4.78	26.0	7.2	33.0	59.0
C0743A	6	24	7/32	0.010	0.25	0.032	0.81	0.201	5.11	26.0	7.2	30.0	55.0
C0754A	7	24	7/32	0.010	0.25	0.032	0.81	0.201	5.11	26.0	7.2	30.0	55.0
C0744A	8	24	7/32	0.010	0.25	0.032	0.81	0.215	5.46	26.0	7.2	30.0	55.0
C0755A	9	24	7/32	0.010	0.25	0.032	0.81	0.228	5.79	26.0	7.2	30.0	55.0
C0745A	10	24	7/32	0.010	0.25	0.032	0.81	0.245	6.22	26.0	7.2	30.0	55.0

*A – Capacitance between conductors

*B – Capacitance between one conductor and other conductors connected to shield

Color Code Chart 1 - For cables up to and including 10 conductors

NO. OF COND.	COLOR	NO. OF COND.	COLOR
1	Black	6	Light Blue
2	White	7	Orange
3	Red	8	Yellow
4	Light Green	9	Purple
5	Light Brown	10	Gray

CATALOG NUMBER	NO. OF COND.	AWG SIZE	COND. STRAND	NOMINAL INSULATION THICKNESS		NOMINAL JACKET THICKNESS		NOMINAL O.D.		NOMINAL DCR Ω/kft @20°C		NOMINAL CAP.* pF/ft	
				INCHES	mm	INCHES	mm	INCHES	mm	COND.	SHLD.	A	B
C0746A	15	24	7/32	0.010	0.25	0.032	0.81	0.276	7.01	26.0	7.2	30.0	55.0
C0747A	20	24	7/32	0.010	0.25	0.032	0.81	0.303	7.70	26.0	7.2	30.0	55.0
C0748A	25	24	7/32	0.010	0.25	0.032	0.81	0.333	8.46	26.0	7.2	30.0	55.0
C0749A	30	24	7/32	0.010	0.25	0.032	0.81	0.351	8.92	26.0	7.2	30.0	55.0
C0750A	40	24	7/32	0.010	0.25	0.032	0.81	0.391	9.93	26.0	7.2	30.0	55.0
C0751A	50	24	7/32	0.010	0.25	0.032	0.81	0.439	11.15	26.0	7.2	30.0	55.0

*A – Capacitance between conductors

*B – Capacitance between one conductor and other conductors connected to shield

Color Code Chart 2 Per ICEA - For cables of 15 thru 50 conductors

NO. OF COND.	COLOR	NO. OF COND.	COLOR	NO. OF COND.	COLOR	NO. OF COND.	COLOR
1	Black	14	Light Green/White	27	Light Blue/Black/White	39	White/Black/Green
2	White	15	Light Blue/White	28	Black/Red/Green	40	Red/White/Green
3	Red	16	Black/Red	29	White/Red/Green	41	Light Green/White/Blue
4	Light Green	17	White/Red	30	Red/Black/Green	42	Orange/Red/Green
5	Orange	18	Orange/Red	31	Light Green/Black/Orange	43	Light Blue/Red/Green
6	Light Blue	19	Light Blue/Red	32	Orange/Black/Green	44	Black/White/Blue
7	White/Black	20	Red/Green	33	Light Blue/White/Orange	45	White/Black/Blue
8	Red/Black	21	Orange/Green	34	Black/White/Orange	46	Red/White/Blue
9	Light Green/Black	22	Black/White/Red	35	White/Red/Orange	47	Light Green/Orange/Red
10	Orange/Black	23	White/Black/Red	36	Orange/White/Blue	48	Orange/Red/Blue
11	Light Blue/Black	24	Red/Black/White	37	White/Red/Blue	49	Light Blue/Red/Orange
12	Black/White	25	Light Green/Black/White	38	Black/White/Green	50	Black/Orange/Red
13	Red/White	26	Orange/Black/White				



Multi-Conductor, Foil Shield

UL 2464, NEC/CEC Type CM or CMR, CMG UL/CSA

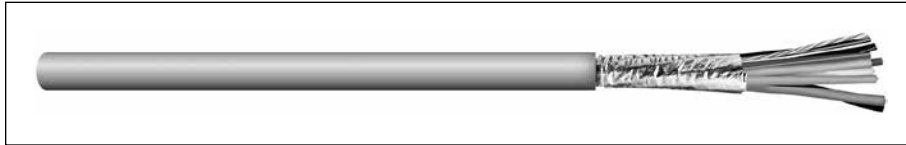

Product Construction:

Conductor:

- 22 or 20 AWG fully annealed stranded tinned copper per ASTM B33

Insulation:

- Premium-grade, color-coded S-R PVC or PVC
- Color code: See chart below

Shield:

- 100% Flexfoil® aluminum/polyester with 25% overlap, minimum, foil facing out
- Stranded tinned copper drain wire

Jacket:

- PVC, gray
- Temperature range: -20°C to +80°C

Applications:

- Computer interconnections
- Data transmission
- Control circuits
- Industrial equipment control
- Suitable for EIA RS-232 applications
- Suggested voltage rating: 300 volts

Compliances:

- NEC Article 800 Type CM - 20 AWG (UL: 75°C)
- NEC Article 800 Type CMR - 20 AWG (UL: 75°C)
- UL Style 2464 (UL: 80°C, 300 V)
- CSA CMG (CSA: 60°C)
- RoHS Compliant Directive 2011/65/EU
- Designed to meet UL 70,000 BTU Vertical Tray Flame Test
- Passes CSA CMG Flame Test
- CE: Low Voltage Directive (LVD) 2006/95/EC

Packaging:

- Please contact Customer Service for packaging and color options

CATALOG NUMBER	NO. OF COND.	AWG SIZE	COND. STRAND	NOMINAL INSULATION THICKNESS		NOMINAL JACKET THICKNESS		NOMINAL O.D.		NOMINAL DCR Ω/kft @20°C		NOMINAL CAP.* pF/ft	
				INCHES	mm	INCHES	mm	INCHES	mm	COND.	SHLD.	A	B

S-R PVC – CMR (UL) c(UL)

C0760A	2	22	7/30	0.010	0.25	0.032	0.81	0.169	4.29	16.5	6.3	36.0	65.0
C0761A	3	22	7/30	0.010	0.25	0.032	0.81	0.177	4.50	16.5	6.3	36.0	65.0
C0762A	4	22	7/30	0.010	0.25	0.032	0.81	0.190	4.83	16.5	6.3	36.0	65.0
C0763A	6	22	7/30	0.010	0.25	0.032	0.81	0.219	5.56	16.5	6.3	34.0	61.0
C0764A	8	22	7/30	0.010	0.25	0.032	0.81	0.235	5.97	16.5	6.3	34.0	61.0
C0765A	10	22	7/30	0.010	0.25	0.032	0.81	0.269	6.83	16.5	6.3	34.0	61.0
C0766A	15	22	7/30	0.010	0.25	0.032	0.81	0.304	7.72	16.5	6.3	34.0	61.0
C0767A	20	22	7/30	0.010	0.25	0.032	0.81	0.335	8.51	16.5	6.3	34.0	61.0
C0768A	25	22	7/30	0.010	0.25	0.032	0.81	0.369	9.37	16.5	6.3	34.0	61.0

PVC – CM (UL) c(UL)

C0780A	2	20	7/28	0.016	0.41	0.032	0.81	0.207	5.26	11.0	6.3	39.0	70.0
C0781A	3	20	7/28	0.016	0.41	0.032	0.81	0.217	5.51	11.0	6.3	39.0	70.0
C0782A	4	20	7/28	0.016	0.41	0.032	0.81	0.236	5.99	11.0	6.3	39.0	70.0
C0783A	6	20	7/28	0.016	0.41	0.032	0.81	0.276	7.01	11.0	6.3	37.0	66.0
C0784A	8	20	7/28	0.016	0.41	0.032	0.81	0.297	7.54	11.0	6.3	37.0	66.0
C0785A	10	20	7/28	0.016	0.41	0.032	0.81	0.345	8.76	11.0	6.3	37.0	66.0
C0786A	15	20	7/28	0.016	0.41	0.032	0.81	0.393	9.98	11.0	6.3	37.0	66.0
C0787A	20	20	7/28	0.016	0.41	0.032	0.81	0.435	11.05	11.0	6.3	37.0	66.0
C0788A	25	20	7/28	0.016	0.41	0.032	0.81	0.483	12.27	11.0	6.3	40.0	72.0

*A – Capacitance between conductors

*B – Capacitance between one conductor and other conductors connected to shield
Data subject to change.

Color Code Chart

NO. OF COND.	COLOR	NO. OF COND.	COLOR	NO. OF COND.	COLOR
1	Black	10	Orange/Black	19	Blue/Red
2	White	11	Blue/Black	20	Red/Green
3	Red	12	Black/White	21	Orange/Green
4	Green	13	Red/White	22	Black/White/Red
5	Orange	14	Green/White	23	White/Black/Red
6	Blue	15	Blue/White	24	Red/Black/White
7	White/Black	16	Black/Red	25	Green/Black/White
8	Red/Black	17	White/Red		
9	Green/Black	18	Orange/Red		



Multi-Conductor, Foil/Braid Shield

UL 2464, NEC Type CL2 or NEC/CEC Type CM, CMG UL/CSA

Product Construction:

Conductor:

- 28 and 24 AWG fully annealed stranded tinned copper per ASTM B33

Insulation:

- Premium-grade, color-coded UL AWM Style 1061
- Color code: See charts below

Shield:

- 100% Flexfoi® aluminum/polyester with 25% overlap, minimum, foil facing out
- Stranded tinned copper drain wire (28 AWG only)
- 65% tinned copper braid

Jacket:

- PVC, gray
- Temperature range: -20°C to +80°C

Applications:

- Computers
- Industrial equipment
- Data transmission
- Control circuits
- Suitable for EIA RS-232 applications
- Suggested voltage rating: 300 volts

Compliances:

- NEC Article 725 Type CL2 - 28 AWG (UL: 75°C)
- NEC Article 800 Type CM - 24 AWG (UL: 75°C)
- UL Style 2464 (UL: 80°C, 300 V)
- CSA CMG (CSA: 60°C)
- RoHS Compliant Directive 2011/65/EU
- Designed to meet UL 70,000 BTU Vertical Tray Flame Test
- Passes CSA CMG Flame Test
- CE: Low Voltage Directive (LVD) 2006/95/EC
- Assists system designers in meeting FCC Docket 20780 demands

Packaging:

- Please contact Customer Service for packaging and color options

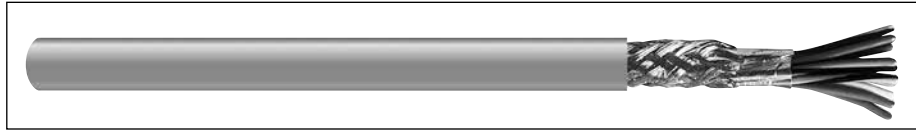

CATALOG NUMBER	NO. OF COND.	AWG SIZE	COND. STRAND	NOMINAL INSULATION THICKNESS		NOMINAL JACKET THICKNESS		NOMINAL O.D.		NOMINAL DCR Ω /kft @20°C		NOMINAL CAP.** pF/ft	
				INCHES	mm	INCHES	mm	INCHES	mm	COND.	SHLD.	A	B

CL2, CMG, UL 2464

C0939A*	3	28	7/36	0.010	0.25	0.032	0.81	0.166	4.22	67.5	5.0	26.0	47.0
C0940A*	4	28	7/36	0.010	0.25	0.032	0.81	0.176	4.47	67.5	5.0	26.0	47.0
C0941A*	5	28	7/36	0.010	0.25	0.032	0.81	0.186	4.72	67.5	5.0	26.0	47.0
C0942A*	6	28	7/36	0.010	0.25	0.032	0.81	0.196	4.98	67.5	5.0	25.0	44.0
C0943A*	7	28	7/36	0.010	0.25	0.032	0.81	0.196	4.98	67.5	5.0	25.0	44.0
C0944A*	8	28	7/36	0.010	0.25	0.032	0.81	0.207	5.26	67.5	5.0	25.0	44.0
C0945A*	9	28	7/36	0.010	0.25	0.032	0.81	0.217	5.51	67.5	5.0	20.0	36.0
C0946A*	10	28	7/36	0.010	0.25	0.032	0.81	0.231	5.87	67.5	5.0	20.0	36.0
C0947A	15	28	7/36	0.010	0.25	0.032	0.81	0.256	6.50	67.5	5.0	20.0	36.0
C0948A	25	28	7/36	0.010	0.25	0.032	0.81	0.301	7.65	67.5	5.0	20.0	36.0

CM, CMG, UL 2464

C0951A	3	24	7/32	0.010	0.25	0.032	0.81	0.186	4.72	25.7	5.3	33.0	59.0
C0952A	4	24	7/32	0.010	0.25	0.032	0.81	0.197	5.00	25.7	5.5	33.0	59.0
C0953A	5	24	7/32	0.010	0.25	0.032	0.81	0.210	5.33	25.7	4.4	33.0	59.0
C0954A	6	24	7/32	0.010	0.25	0.032	0.81	0.223	5.66	25.7	4.6	30.0	55.0
C0955A	7	24	7/32	0.010	0.25	0.032	0.81	0.223	5.66	25.7	4.6	30.0	55.0
C0956A	8	24	7/32	0.010	0.25	0.032	0.81	0.237	6.02	25.7	3.8	30.0	55.0
C0957A	9	24	7/32	0.010	0.25	0.032	0.81	0.250	6.35	25.7	3.9	30.0	55.0
C0958A	10	24	7/32	0.010	0.25	0.032	0.81	0.267	6.78	25.7	4.2	30.0	55.0
C0959A	15	24	7/32	0.010	0.25	0.032	0.81	0.298	7.57	25.7	3.6	30.0	55.0
C0960A	20	24	7/32	0.010	0.25	0.032	0.81	0.325	8.26	25.7	4.5	30.0	55.0
C0961A	25	24	7/32	0.010	0.25	0.032	0.81	0.355	9.02	25.7	3.5	30.0	55.0

*Color Code Chart 1. Remaining items Color Code Chart 2
 **A - Capacitance between conductors
 **B - Capacitance between one conductor and other conductors connected to shield
 Data subject to change.

Color Code Chart 1

NO. OF COND.	COLOR	NO. OF COND.	COLOR
1	Black	6	Light Blue
2	White	7	Orange
3	Red	8	Yellow
4	Light Green	9	Purple
5	Light Brown	10	Gray

Color Code Chart 2 Per ICEA

NO. OF COND.	COLOR	NO. OF COND.	COLOR	NO. OF COND.	COLOR
1	Black	10	Orange/Black	19	Light Blue/Red
2	White	11	Light Blue/Black	20	Red/Green
3	Red	12	Black/White	21	Orange/Green
4	Light Green	13	Red/White	22	Black/White/Red
5	Orange	14	Light Green/White	23	White/Black/Red
6	Light Blue	15	Light Blue/White	24	Red/Black/White
7	White/Black	16	Black/Red	25	Light Green/Black/White
8	Red/Black	17	White/Red		
9	Light Green/Black	18	Orange/Red		



Multi-Conductor, Foil/Braid Shield

UL 2464, NEC/CEC Type CMR, CMG UL/CSA

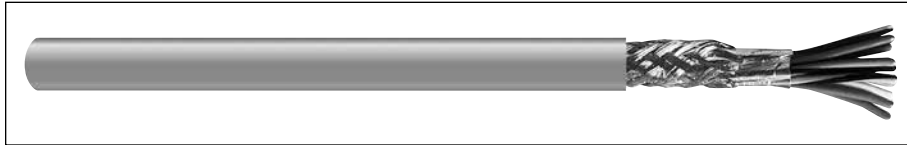

CATALOG NUMBER	NO. OF COND.	AWG SIZE	COND. STRAND	NOMINAL INSULATION THICKNESS		NOMINAL JACKET THICKNESS		NOMINAL O.D.		NOMINAL DCR Ω /kft @20°C		NOMINAL CAP.* pF/ft	
				INCHES	mm	INCHES	mm	INCHES	mm	COND.	SHLD.	A	B
C0971A	3	22	7/30	0.010	0.25	0.032	0.81	0.199	5.05	16.6	5.6	36.0	66.0
C0972A	4	22	7/30	0.010	0.25	0.032	0.81	0.212	5.38	16.6	4.4	36.0	66.0
C0973A	5	22	7/30	0.010	0.25	0.032	0.81	0.226	5.74	16.6	4.7	36.0	66.0
C0974A	6	22	7/30	0.010	0.25	0.032	0.81	0.241	6.12	16.6	3.8	34.0	60.0
C0975A	7	22	7/30	0.010	0.25	0.032	0.81	0.241	6.12	16.6	6.2	34.0	60.0
C0976A	8	22	7/30	0.010	0.25	0.032	0.81	0.257	6.53	16.6	4.0	34.0	60.0
C0977A	9	22	7/30	0.010	0.25	0.032	0.81	0.272	6.91	16.6	3.4	34.0	60.0
C0978A	10	22	7/30	0.010	0.25	0.032	0.81	0.291	7.39	16.6	3.6	34.0	60.0
C0979A	15	22	7/30	0.010	0.25	0.032	0.81	0.326	8.28	16.6	3.6	34.0	60.0
C0980A	20	22	7/30	0.010	0.25	0.032	0.81	0.357	9.07	16.6	3.9	34.0	60.0
C0981A	25	22	7/30	0.010	0.25	0.032	0.81	0.391	9.93	16.6	2.7	34.0	60.0

*A – Capacitance between conductors

*B – Capacitance between one conductor and other conductors connected to shield
Data subject to change.

Color Code Chart Per ICEA

NO. OF COND.	COLOR	NO. OF COND.	COLOR	NO. OF COND.	COLOR
1	Black	10	Orange/Black	19	Light Blue/Red
2	White	11	Light Blue/Black	20	Red/Green
3	Red	12	Black/White	21	Orange/Green
4	Light Green	13	Red/White	22	Black/White/Red
5	Orange	14	Light Green/White	23	White/Black/Red
6	Light Blue	15	Light Blue/White	24	Red/Black/White
7	White/Black	16	Black/Red	25	Light Green/Black/White
8	Red/Black	17	White/Red		
9	Light Green/Black	18	Orange/Red		

Product Construction:

Conductor:

- 22 AWG fully annealed stranded tinned copper per ASTM B33

Insulation:

- Premium-grade, color-coded S-R PVC per UL 1061
- Color code: See chart below

Shield:

- 100% Flexfoil® aluminum/polyester with 25% overlap, minimum, foil facing out
- 65% tinned copper braid

Jacket:

- PVC, gray
- Temperature range: -20°C to +80°C

Applications:

- Computers
- Industrial equipment
- Data transmission
- Control circuits
- Suitable for EIA RS-232 applications
- Suggested voltage rating: 300 volts

Compliances:

- NEC Article 800 Type CMR (UL: 75°C)
- UL Style 2464 (UL: 80°C, 300 V)
- CSA CMG (CSA: 60°C)
- RoHS Compliant Directive 2011/65/EU
- Designed to meet UL 70,000 BTU Vertical Tray Flame Test
- Passes CSA CMG Flame Test
- CE: Low Voltage Directive (LVD) 2006/95/EC
- Assists system designers in meeting FCC Docket 20780 demands

Packaging:

- Please contact Customer Service for packaging and color options

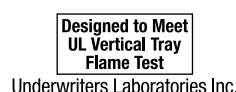

Multi-Conductor, Foil/Braid Shield, Lo-Cap®

UL 2919, NEC Type CL2 or NEC/CEC Type CM, CEC Type CMH UL/CSA

Product Construction:

Conductor:

- 24 AWG fully annealed stranded tinned copper per ASTM B33

Insulation:

- Premium grade foamed Lo-Cap® color coded polypropylene
- Color code: See chart below

Shield:

- 100% Flexfoi® aluminum/polyester with 25% overlap, minimum, foil facing out
- Stranded tinned copper drain wire
- 70% tinned copper braid

Jacket:

- PVC, gray
- Temperature range: -20°C to +80°C

Applications:

- High speed computers
- Industrial equipment
- Control circuits
- Designed for low capacitance applications
- Suitable for EIA RS-232 and RS-423 CAD/CAM applications
- Suggested voltage rating: 30 volts

Compliances:

- NEC Article 800 Type CM (UL: 75°C, 300 V)
- UL Style 2919 (UL: 80°C, 30 V)
- CSA CMH (CSA: 60°C)
- RoHS Compliant Directive 2011/65/EU
- Designed to meet UL 70,000 BTU Vertical Tray Flame Test
- Passes CSA CMH Flame Test
- CE: Low Voltage Directive (LVD) 2006/95/EC
- Assists system designers in meeting FCC Docket 20780 demands

Packaging:

- Please contact Customer Service for packaging and color options

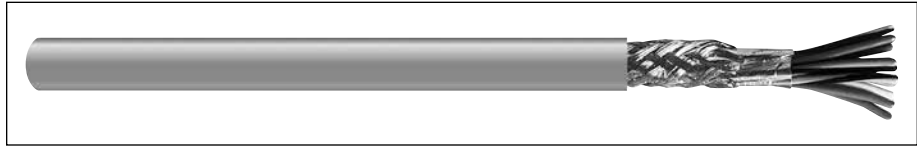

CATALOG NUMBER	NO. OF COND.	NOM. INSULATION THICKNESS		NOM. JACKET THICKNESS		NOMINAL O.D.		NOMINAL DCR Ω/kft		NOMINAL CAP.* pF/ft		
		INCHES	mm	INCHES	mm	INCHES	mm	COND.	SHLD.	A	B	
24 AWG (7/32): CM (UL) c(UL) CMH, AWM Style 2919												
C0680A	3	0.016	0.41	0.032	0.81	0.211	5.36	25.7	3.8	11.9	21.5	
C0681A	4	0.016	0.41	0.032	0.81	0.227	5.77	25.7	3.8	11.9	21.5	
C0682A	5	0.016	0.41	0.032	0.81	0.242	6.15	25.7	3.8	11.9	21.5	
C0683A	6	0.016	0.41	0.032	0.81	0.259	6.58	25.7	3.2	11.2	20.2	
C0684A	7	0.016	0.41	0.032	0.81	0.259	6.58	25.7	3.2	11.2	20.2	
C0685A	8	0.016	0.41	0.032	0.81	0.276	7.01	25.7	3.2	11.2	20.2	
C0686A	9	0.016	0.41	0.032	0.81	0.293	7.44	25.7	3.6	11.2	20.2	
C0687A	10	0.016	0.41	0.032	0.81	0.315	8.00	25.7	3.6	11.2	20.2	
C0688A	15	0.016	0.41	0.032	0.81	0.354	8.99	25.7	3.6	11.2	20.2	

*A – Capacitance between conductors
 *B – Capacitance between one conductor and other conductors connected to shield
 Vp = 78%
 Impedance: ≈100 Ω
 Data subject to change.

Color Code Chart 1 - For cables up to and including 10 conductors

NO. OF COND.	COLOR	NO. OF COND.	COLOR
1	Black	6	Light Blue
2	White	7	Orange
3	Red	8	Yellow
4	Light Green	9	Purple
5	Brown	10	Gray

Color Code Chart 2 Per ICEA - For cables up to 15 conductors

NO. OF COND.	COLOR	NO. OF COND.	COLOR
1	Black	10	Orange/Black
2	White	11	Light Blue/Black
3	Red	12	Black/White
4	Light Green	13	Red/White
5	Orange	14	Light Green/White
6	Light Blue	15	Light Blue/White
7	White/Black		
8	Red/Black		
9	Light Green/Black		

Multi-Paired, Foil Shield

UL 2464, NEC/CEC Type CMR, CMG UL/CSA

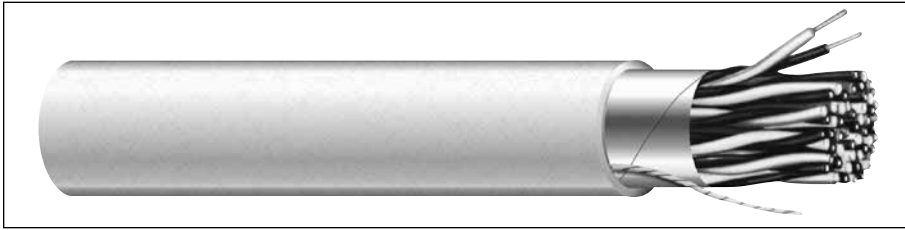

Product Construction:

Conductor:

- 24 AWG fully annealed stranded tinned copper per ASTM B33
- Twisted pairs

Insulation:

- Premium-grade, color-coded S-R PVC per UL 1061
- Color code: See chart below

Shield:

- 100% Flexfoil® aluminum/polyester with 25% overlap, minimum, foil facing out
- Stranded tinned copper drain wire

Jacket:

- PVC, gray
- Temperature range: -20°C to +80°C

Applications:

- Computers
- Industrial equipment
- Data transmission
- Control circuits
- Suitable for EIA RS-232 applications
- Suggested voltage rating: 300 volts

Compliances:

- NEC Article 800 Type CMR (UL: 75°C)
- UL Style 2464 (UL: 80°C, 300 V)
- CSA CMG (CSA, 60°C)
- RoHS Compliant Directive 2011/65/EU
- Designed to meet UL 70,000 BTU Vertical Tray Flame Test
- Passes CSA CMG Flame Test
- CE: Low Voltage Directive (LVD) 2006/95/EC
- Assists system designers in meeting FCC Docket 20780 demands

Packaging:

- Please contact Customer Service for packaging and color options

Data subject to change.

CATALOG NUMBER	NO. OF PAIRS	AWG SIZE	COND. STRAND	NOMINAL INSULATION THICKNESS		NOMINAL JACKET THICKNESS		NOMINAL O.D.		NOMINAL DCR Ω/kft		NOMINAL CAP.* pF/ft	
				INCHES	mm	INCHES	mm	INCHES	mm	COND.	SHLD.	A	B
C0600A	1	24	7/32	0.010	0.25	0.032	0.81	0.157	3.99	25.7	7.2	19.7	21.5
C0601A	2	24	7/32	0.010	0.25	0.032	0.81	0.214	5.44	25.7	7.2	28.7	21.5
C0602A	3	24	7/32	0.010	0.25	0.032	0.81	0.225	5.72	25.7	7.2	25.7	21.5
C0603A	4	24	7/32	0.010	0.25	0.032	0.81	0.245	6.23	25.7	7.2	25.7	20.2
C0604A	5	24	7/32	0.010	0.25	0.032	0.81	0.265	6.73	25.7	7.2	25.7	20.2
C0605A	6	24	7/32	0.010	0.25	0.032	0.81	0.287	7.29	25.7	7.2	23.7	42.7
C0606A	7	24	7/32	0.010	0.25	0.032	0.81	0.287	7.29	25.7	7.2	23.7	42.7
C0607A	8	24	7/32	0.010	0.25	0.032	0.81	0.309	7.85	25.7	7.2	23.7	42.7
C0608A	9	24	7/32	0.010	0.25	0.032	0.81	0.331	8.41	25.7	7.2	23.7	42.7
C0609A	10	24	7/32	0.010	0.25	0.032	0.81	0.359	9.12	25.7	7.2	23.7	42.7
C0610A	15	24	7/32	0.010	0.25	0.032	0.81	0.410	10.41	25.7	7.2	23.7	42.7
C0611A	19	24	7/32	0.010	0.25	0.032	0.81	0.432	10.97	25.7	7.2	23.7	42.7
C0612A	25	24	7/32	0.010	0.25	0.032	0.81	0.505	12.84	25.7	7.2	23.7	42.7
C0720A	1	22	7/30	0.010	0.25	0.032	0.81	0.169	4.29	16.6	6.2	40.4	72.6
C0721A	2	22	7/30	0.010	0.25	0.032	0.81	0.234	5.94	16.6	6.2	32.3	58.1
C0722A	3	22	7/30	0.010	0.25	0.032	0.81	0.246	6.25	16.6	6.2	27.8	50.1
C0723A	4	22	7/30	0.010	0.25	0.032	0.81	0.269	6.83	16.6	6.2	27.8	50.1
C0724A	5	22	7/30	0.010	0.25	0.032	0.81	0.292	7.42	16.6	6.2	27.8	50.1
C0725A	6	22	7/30	0.010	0.25	0.032	0.81	0.317	8.05	16.6	6.2	25.5	45.9
C0726A	9	22	7/30	0.010	0.25	0.032	0.81	0.367	9.32	16.6	6.2	25.5	45.9
C0728A	15	22	7/30	0.010	0.25	0.032	0.81	0.457	11.62	16.6	6.2	25.5	45.9
C0729A	19	22	7/30	0.010	0.25	0.032	0.81	0.482	12.24	16.6	6.2	25.5	45.9
C0730A	27	22	7/30	0.010	0.25	0.032	0.81	0.576	14.36	16.6	6.2	26.0	46.0

*A – Capacitance between conductors

*B – Capacitance between one conductor and other conductors connected to shield

Color Code Chart

NO. OF PAIRS	COLOR	NO. OF PAIRS	COLOR
1	Black with Red	14	Green with White
2	Black with White	15	Green with Blue
3	Black with Green	16	Green with Yellow
4	Black with Blue	17	Green with Brown
5	Black with Yellow	18	Green with Orange
6	Black with Brown	19	White with Blue
7	Black with Orange	20	White with Yellow
8	Red with White	21	White with Brown
9	Red with Green	22	White with Orange
10	Red with Blue	23	Blue with Yellow
11	Red with Yellow	24	Blue with Brown
12	Red with Brown	25	Blue with Orange
13	Red with Orange	26	Brown with Yellow
		27	Brown with Orange



Multi-Paired, Foil Shield, Lo-Cap®

UL 2448, NEC Type CM (UL) c(UL), CMH

Product Construction:

Conductor:

- 24 AWG fully annealed stranded tinned copper per ASTM B33
- Twisted pairs

Insulation:

- Premium-grade, color-coded polyethylene
- Color code: See chart below

Shield:

- 100% Flexfoil® aluminum/polyester with 25% overlap, minimum, foil facing out
- Stranded tinned copper drain wire

Jacket:

- PVC, gray
- Temperature range: -20°C to +75°C

Applications:

- Computers
- Industrial equipment
- Data transmission
- Control circuits
- Suitable for low capacitance applications
- Suggested voltage rating: 30 volts

Compliances:

- NEC Article 800 Type CM (UL: 75°C)
- UL Style 2448 (UL: 60°C, 30 V)
- CSA CMH (CSA: 60°C)
- RoHS Compliant Directive 2011/65/EU
- Designed to meet UL 70,000 BTU Vertical Tray Flame Test
- Passes CSA CMH Flame Test
- CE: Low Voltage Directive (LVD) 2006/95/EC

Packaging:

- Please contact Customer Service for packaging and color options

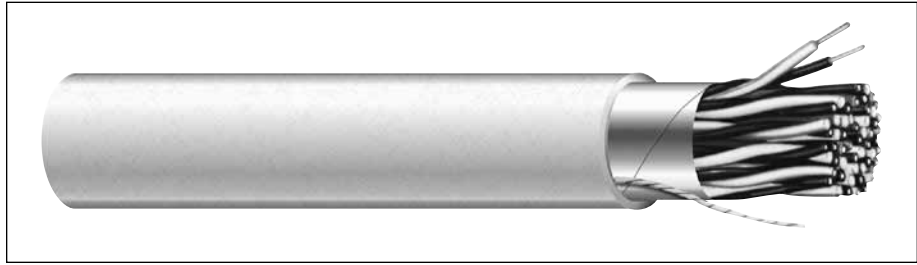

CATALOG NUMBER	NO. OF PAIRS	AWG SIZE	COND. STRAND	NOM. INSULATION THICKNESS		NOM. JACKET THICKNESS		NOMINAL O.D.		NOMINAL DCR Ω/kt		VEL. OF PROP., %	NOM. IMP., Ω	NOMINAL CAP.* pF/ft	
				INCHES	mm	INCHES	mm	INCHES	mm	COND.	SHLD.			A	B
C0890A	2	24	7/32	0.015	0.38	0.032	0.81	0.247	6.27	25.7	7.20	66	100	14.4	26.0
C0901A	3	24	7/32	0.015	0.38	0.032	0.81	0.261	6.63	25.7	7.20	66	100	13.9	25.1
C0893A	4	24	7/32	0.015	0.38	0.032	0.81	0.277	7.04	25.7	7.20	66	100	13.9	25.1
C0894A	5	24	7/32	0.015	0.38	0.032	0.81	0.310	7.87	25.7	7.20	66	100	13.9	25.1
C0899A	6	24	7/32	0.015	0.38	0.032	0.81	0.336	8.53	25.7	7.20	66	100	13.0	23.4
C0896A	9	24	7/32	0.015	0.38	0.032	0.81	0.391	9.93	25.7	7.20	66	100	13.0	23.4
C0897A	12.5	24	7/32	0.015	0.38	0.032	0.97	0.459	11.66	25.7	7.20	66	100	13.0	23.4

*A – Capacitance between conductors

*B – Capacitance between one conductor and other conductors connected to shield
Data subject to change.

Color Code Chart

NO. OF PAIRS	COLOR	NO. OF PAIRS	COLOR
1	Black paired with White	7	White/Blue paired with Blue/White
2	Red paired with Green	8	White/Brown paired with Brown/White
3	Brown paired with Blue	9	White/Orange paired with Orange/White
4	Orange paired with Yellow	10	White/Green paired with Green/White
5	Purple paired with Gray	11	White/Red paired with Red/White
6	Tan paired with Pink	12	White/Black paired with Black/White

Single Conductor: Green With Yellow Stripe

Multi-Paired, Foil/Braid Shield

UL 2464, NEC/CEC Type CMR, CMG UL/CSA

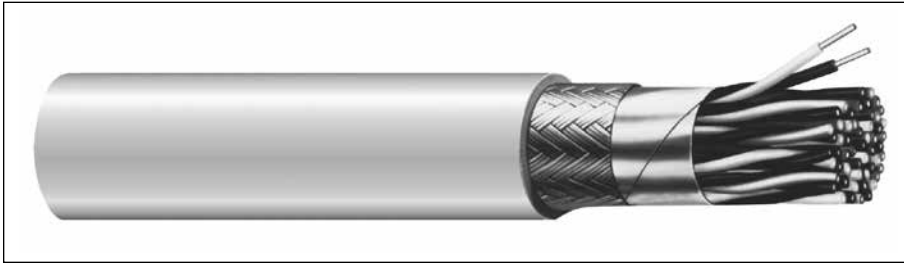

Product Construction:

Conductor:

- 22 and 24 AWG fully annealed stranded tinned copper per ASTM B33
- Twisted pairs

Insulation:

- Premium-grade, color-coded S-R PVC per UL 1061
- Color code: See chart below

Shield:

- 100% Flexfoil® aluminum/polyester with 25% overlap, minimum, foil facing out
- 65% tinned copper braid

Jacket:

- PVC, gray
- Temperature range: -20°C to +80°C

Applications:

- Computers
- Industrial equipment
- Data transmission
- Control circuits
- Suitable for EIA RS-232 applications
- Suggested voltage rating: 300 volts

Compliances:

- NEC Article 800 Type CMR (UL: 75°C)
- UL Style 2464 (UL: 80°C, 300 V)
- CSA CMG (CSA: 60°C)
- RoHS Compliant Directive 2011/65/EU
- Designed to meet UL 70,000 BTU Vertical Tray Flame Test
- Passes CSA CMG Flame Test
- CE: Low Voltage Directive (LVD) 2006/95/EC
- Assists system designers in meeting FCC Docket 20789 demands

Packaging:

- Please contact Customer Service for packaging and color options

Data subject to change.

CATALOG NUMBER	NO. OF PAIRS	AWG SIZE	COND. STRAND	NOMINAL INSULATION THICKNESS		NOMINAL JACKET THICKNESS		NOMINAL O.D.		NOMINAL DCR Ω/kft		NOMINAL CAP* pF/ft	
				INCHES	mm	INCHES	mm	INCHES	mm	COND.	SHLD.	A	B
C0620A	2	24	7/32	0.010	0.25	0.032	0.81	0.235	5.97	25.7	5.4	29.5	53.0
C0621A	3	24	7/32	0.010	0.25	0.032	0.81	0.231	5.87	25.7	5.0	26.4	47.6
C0622A	4	24	7/32	0.010	0.25	0.032	0.81	0.253	6.43	25.7	4.5	26.4	47.6
C0623A	5	24	7/32	0.010	0.25	0.032	0.81	0.278	7.06	25.7	4.6	26.4	47.6
C0624A	6	24	7/32	0.010	0.25	0.032	0.81	0.296	7.52	25.7	2.9	24.4	43.9
C0625A	7	24	7/32	0.010	0.25	0.032	0.81	0.313	7.95	25.7	3.1	24.4	43.9
C0626A	8	24	7/32	0.010	0.25	0.032	0.81	0.336	8.53	25.7	4.1	24.4	43.9
C0628A	10	24	7/32	0.010	0.25	0.032	0.81	0.357	9.07	25.7	2.6	24.4	43.9
C0630A	12.5	24	7/32	0.010	0.25	0.032	0.81	0.386	9.80	25.7	3.6	24.4	43.9
C0650A	2	22	7/30	0.010	0.25	0.032	0.81	0.229	5.82	16.6	3.8	33.2	59.7
C0651A	3	22	7/30	0.010	0.25	0.032	0.81	0.296	7.52	16.6	4.1	28.6	51.5
C0652A	4	22	7/30	0.010	0.25	0.032	0.81	0.320	8.13	16.6	3.5	28.6	51.5
C0653A	5	22	7/30	0.010	0.25	0.032	0.81	0.331	8.41	16.6	3.9	28.6	51.5
C0654A	6	22	7/30	0.010	0.25	0.032	0.81	0.348	8.84	16.6	4.4	26.2	47.2
C0655A	7	22	7/30	0.010	0.25	0.032	0.81	0.348	8.84	16.6	5.0	26.2	47.2
C0656A	8	22	7/30	0.010	0.25	0.032	0.81	0.368	9.35	16.6	3.8	26.2	47.2
C0658A	10	22	7/30	0.010	0.25	0.032	0.81	0.388	9.86	16.6	4.1	26.2	47.2
C0660A	12.5	22	7/30	0.010	0.25	0.032	0.81	0.429	10.90	16.6	4.7	26.2	47.2
C0663A	25	22	7/30	0.010	0.25	0.058	0.81	0.620	15.75	16.6	2.1	26.2	46.0

*A - Capacitance between conductors

*B - Capacitance between one conductor and other conductors connected to shield

Color Code Chart

NO. OF PAIRS	COLOR	NO. OF PAIRS	COLOR
1	Black paired with Red	13	Red paired with Orange
2	Black paired with White	14	White paired with Green
3	Black paired with Green	15	Blue paired with Green
4	Black paired with Blue	16	Yellow paired with Green
5	Black paired with Yellow	17	Brown paired with Green
6	Black paired with Brown	18	Orange paired with Green
7	Black paired with Orange	19	White paired with Blue
8	Red paired with White	20	White paired with Yellow
9	Red paired with Green	21	White paired with Brown
10	Red paired with Blue	22	White paired with Orange
11	Red paired with Yellow	23	Yellow paired with Blue
12	Red paired with Brown	24	Blue paired with Brown
		25	Orange paired with Blue
Single Conductor: Green with Yellow Stripe			

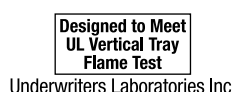

Multi-Paired, Foil/Braid Shield, Lo-Cap®

UL 2919, NEC Type CM (UL) c(UL) CMH

Product Construction:

Conductor:

- 24 AWG fully annealed stranded tinned copper per ASTM B33
- Twisted pairs

Insulation:

- Premium-grade, color-coded polyethylene
- Color code: See charts below

Shield:

- 100% Flexfoil® aluminum/polyester with 25% overlap, minimum, foil facing out
- Stranded tinned copper drain wire
- 90% tinned copper braid

Jacket:

- PVC, gray
- Temperature range: -20°C to +80°C

Applications:

- Computers
- Industrial equipment
- Data transmission
- Control circuits
- Low capacitance requirements
- Suitable for EIA RS-485 applications
- Suggested voltage rating: 30 volts

Compliances:

- NEC Article 800 Type CM/CMH (UL: 75°C, 300 V)
- UL Style 2919 (UL: 80°C, 30 V)
- RoHS Compliant Directive 2011/65/EU
- Designed to meet UL 70,000 BTU Vertical Tray Flame Test
- Passes CSA CMH Flame Test
- CE: Low Voltage Directive (LVD) 2006/95/EC
- Assists system designers in meeting FCC Docket 20789 demands

Packaging:

- Please contact Customer Service for packaging and color options

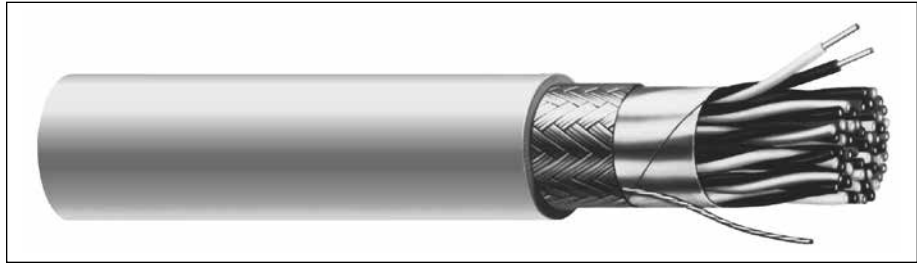

CATALOG NUMBER	NO. OF PAIRS	AWG SIZE	COND. STRAND	NOM. INSULATION THICKNESS		NOM. JACKET THICKNESS		NOMINAL O.D.		NOMINAL DCR Ω/kft		VEL. OF PROP., %	NOM. IMP., Ω	NOMINAL CAP.* pF/ft	
				INCHES	mm	INCHES	mm	INCHES	mm	COND.	SHLD.			A	B
C0841A	1	24	7/32	0.024	0.61	0.032	0.81	0.235	5.97	25.7	2.9	66	120	14.6	26.2
C0842A	2	24	7/32	0.024	0.61	0.032	0.81	0.304	7.72	25.7	2.3	66	120	11.7	21.0
C0843A	3	24	7/32	0.024	0.61	0.032	0.81	0.360	9.14	25.7	2.3	66	120	11.9	21.4
C0844A	4	24	7/32	0.024	0.61	0.032	0.81	0.390	9.91	25.7	2.1	66	120	11.9	21.4

*A – Capacitance between conductors

*B – Capacitance between one conductor and other conductors connected to shield

Data subject to change.

Color Code Chart 1

NO. OF PAIRS	COLOR
1	Black paired with Red
2	Black paired with White
3	Black paired with Green
4	Black paired with Blue

CATALOG NUMBER	NO. OF PAIRS	AWG SIZE	COND. STRAND	NOM. INSULATION THICKNESS		NOM. JACKET THICKNESS		NOMINAL O.D.		NOMINAL DCR Ω/kft		VEL. OF PROP., %	NOM. IMP., Ω	NOMINAL CAP.* pF/ft	
				INCHES	mm	INCHES	mm	INCHES	mm	COND.	SHLD.			A	B
C4841A	1	24	7/32	0.024	0.61	0.032	0.81	0.235	5.97	25.7	2.9	66	120	14.6	26.2
C4842A	2	24	7/32	0.024	0.61	0.032	0.81	0.304	7.72	25.7	2.3	66	120	11.7	21.0
C4843A	3	24	7/32	0.024	0.61	0.032	0.81	0.360	9.14	25.7	2.3	66	120	11.9	21.4
C4844A	4	24	7/32	0.024	0.61	0.032	0.81	0.390	9.91	25.7	2.1	66	120	11.9	21.4

*A – Capacitance between conductors

*B – Capacitance between one conductor and other conductors connected to shield

Data subject to change.

Color Code Chart 2

NO. OF PAIRS	COLOR	NO. OF PAIRS	COLOR
1	White-Blue Stripe Blue-White Stripe	3	White-Green Stripe Green-White Stripe
2	White-Orange Stripe Orange-White Stripe	4	White-Brown Stripe Brown-White Stripe

Multi-Paired, Foil/Braid Shield, Lo-Cap®

UL 2919, NEC Type CM (UL) c(UL) CMH

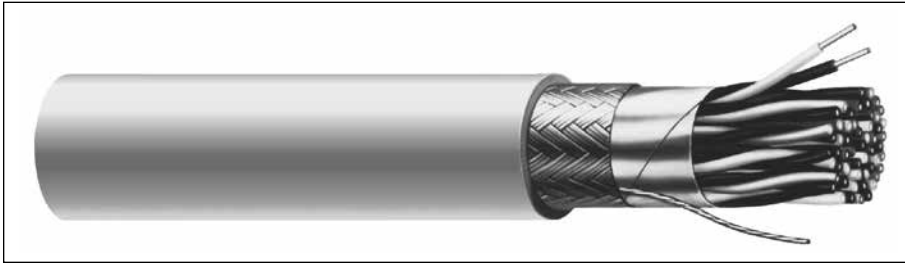

Product Construction:

Conductor:

- 24 AWG fully annealed stranded tinned copper per ASTM B33
- Twisted pairs

Insulation:

- Premium-grade, color-coded polyethylene
- Color code: See chart below

Shield:

- 100% Flexfoil® aluminum/polyester with 25% overlap, minimum, foil facing out
- Stranded tinned copper drain wire
- 90% tinned copper braid

Jacket:

- PVC, gray
- Temperature range: -20°C to +80°C

Applications:

- Computers
- Industrial equipment
- Data transmission
- Control circuits
- Low capacitance requirements
- Suitable for EIA RS-232 applications
- Suitable for EIA RS-422 applications
- Suggested voltage rating: 30 volts

Compliances:

- NEC Article 800 Type CM/CMH (UL: 75°C)
- UL Style 2919 (UL: 80°C, 30 V)
- CSA CMH (CSA: 60°C)
- RoHS Compliant Directive 2011/65/EU
- Designed to meet UL 70,000 BTU Vertical Tray Flame Test
- Passes CSA CMH Flame Test
- CE: Low Voltage Directive (LVD) 2006/95/EC
- Assists system designers in meeting FCC Docket 20789 demands

Packaging:

- Please contact Customer Service for packaging and color options

CATALOG NUMBER	NO. OF PAIRS	AWG SIZE	COND. STRAND	NOM. INSULATION THICKNESS		NOM. JACKET THICKNESS		NOMINAL O.D.		NOMINAL DCR Ω/kft		VEL. OF PROP., %	NOM. IMP., Ω	NOMINAL CAP.* pF/ft	
				INCHES	mm	INCHES	mm	INCHES	mm	COND.	SHLD.			A	B
C0829A	2	24	7/32	0.015	0.38	0.032	0.81	0.257	6.53	25.7	2.7	66	100	14.8	26.7
C0830A	3	24	7/32	0.015	0.38	0.032	0.81	0.289	7.34	25.7	2.6	66	100	14.2	25.5
C0831A	4	24	7/32	0.015	0.38	0.032	0.81	0.313	7.95	25.7	3.2	66	100	14.2	25.5
C0832A	5	24	7/32	0.015	0.38	0.032	0.81	0.338	8.59	25.7	1.9	66	100	14.2	25.5
C0839A	6	24	7/32	0.015	0.38	0.032	0.81	0.364	9.24	25.7	2.4	66	100	13.2	23.8
C0833A	7	24	7/32	0.015	0.38	0.032	0.81	0.364	9.24	25.7	2.0	66	100	13.2	23.8
C0835A	10	24	7/32	0.015	0.38	0.038	0.97	0.462	11.73	25.7	1.7	66	100	13.2	23.8
C0836A	12	24	7/32	0.015	0.38	0.038	0.97	0.479	12.17	25.7	1.8	66	100	13.2	23.8

*A – Capacitance between conductors

*B – Capacitance between one conductor and other conductors connected to shield

Data subject to change.

Color Code Chart

NO. OF COND.	COLOR	NO. OF COND.	COLOR
1	Black paired with Red	7	Black paired with Orange
2	Black paired with White	8	Red paired with White
3	Black paired with Green	9	Red paired with Green
4	Black paired with Blue	10	Red paired with Blue
5	Black paired with Yellow	11	Red paired with Yellow
6	Black paired with Brown	12	Red paired with Brown



Designed to Meet
UL Vertical Tray
Flame Test

Underwriters Laboratories Inc.



Multi-Paired, Foil/Braid Shield, Lo-Cap®

UL 2919, NEC Type CM (UL) c(UL) CMH

Product Construction:

Conductor:

- 24 AWG fully annealed stranded tinned copper per ASTM B33
- Twisted pairs

Insulation:

- Premium-grade, color-coded Lo-Cap® foamed polypropylene
- Color code: See chart below

Shield:

- 100% Flexfoil® aluminum/polyester with 25% overlap, minimum, foil facing out
- Stranded tinned copper drain wire
- 65% tinned copper braid

Jacket:

- PVC, gray
- Temperature range: -20°C to +80°C

Applications:

- High-speed computer interconnects
- CAD/CAM systems
- EIA RS-232 and RS-423 systems
- Control circuits
- Industrial equipment
- Low signal distortion data requirements
- Suggested voltage rating: 30 volts
- Suitable for EIA RS-485 120Ω applications

Compliances:

- NEC Article 800 Type CM/CMH (UL: 75°C, 300 V)
- UL Style 2919 (UL: 80°C, 30 V)
- RoHS Compliant Directive 2011/65/EU
- Designed to meet UL 70,000 BTU Vertical Tray Flame Test
- CE: Low Voltage Directive (LVD) 2006/95/EC
- Assists system designers in meeting FCC Docket 20789 demands

Packaging:

- Please contact Customer Service for packaging and color options

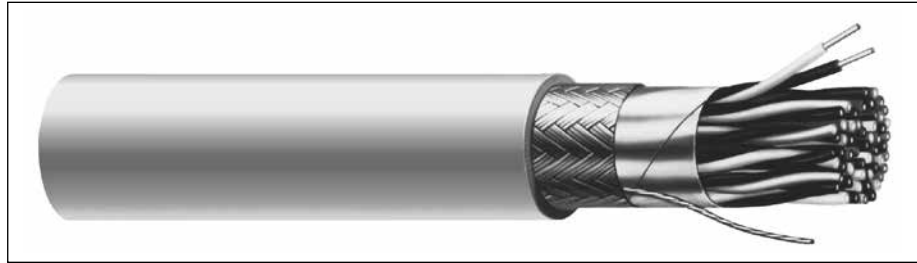

CATALOG NUMBER	NO. OF PAIRS	AWG SIZE	COND. STRAND	NOM. INSULATION THICKNESS		NOM. JACKET THICKNESS		NOMINAL O.D.		NOMINAL DCR Ω/kft		VEL. OF PROP., %	NOM. IMP., Ω	NOMINAL CAP.* pF/ft	
				INCHES	mm	INCHES	mm	INCHES	mm	COND.	SHLD.			A	B
C0515A	2	24	7/32	0.016	0.41	0.032	0.81	0.276	7.01	25.7	3.0	78	132	10.2	18.4
C0516A	3	24	7/32	0.016	0.41	0.032	0.81	0.290	7.37	25.7	3.2	78	132	9.9	17.8
C0517A	4	24	7/32	0.016	0.41	0.032	0.81	0.315	8.00	25.7	3.3	78	132	9.9	17.8
C0518A	5	24	7/32	0.016	0.41	0.032	0.81	0.340	8.64	25.7	4.2	78	132	9.9	17.8
C0519A	6	24	7/32	0.016	0.41	0.032	0.81	0.368	9.35	25.7	3.6	78	141	9.2	16.6
C0520A	7	24	7/32	0.016	0.41	0.032	0.81	0.370	9.40	25.7	3.5	78	141	9.2	16.6
C0521A	8	24	7/32	0.016	0.41	0.032	0.81	0.397	10.08	25.7	2.7	78	141	9.2	16.6
C0522A	10	24	7/32	0.016	0.41	0.038	0.97	0.473	12.01	25.7	2.4	78	141	9.2	16.6
C0523A	12.5	24	7/32	0.016	0.41	0.038	0.97	0.486	12.34	25.7	2.4	78	141	9.2	16.6
C0524A	15	24	7/32	0.016	0.41	0.048	1.22	0.555	14.10	25.7	2.6	78	141	9.2	16.6
C0525A	18	24	7/32	0.016	0.41	0.048	1.22	0.585	14.86	25.7	2.1	78	141	9.2	16.6
C0526A	25	24	7/32	0.016	0.41	0.048	1.22	0.677	17.20	25.7	2.0	78	141	9.2	16.6

*A – Capacitance between conductors

*B – Capacitance between one conductor and other conductors connected to shield
Data subject to change.

Color Code Chart

NO. OF PAIRS	COLOR	NO. OF PAIRS	COLOR	NO. OF PAIRS	COLOR
1	White-Blue Stripe Blue-White Stripe	10	Red-Gray Stripe Gray-Red Stripe	18	Yellow-Green Stripe Green-Yellow Stripe
2	White-Orange Stripe Orange-White Stripe	11	Black-Blue Stripe Blue-Black Stripe	19	Yellow-Brown Stripe Brown-Yellow Stripe
3	White-Green Stripe Green-White Stripe	12	Black-Orange Stripe Orange-Black Stripe	20	Yellow-Gray Stripe Gray-Yellow Stripe
4	White-Brown Stripe Brown-White Stripe	13	Black-Green Stripe Green-Black Stripe	21	Purple-Blue Stripe Blue-Purple Stripe
5	White-Gray Stripe Gray-White Stripe	14	Black-Brown Stripe Brown-Black Stripe	22	Purple-Orange Stripe Orange-Purple Stripe
6	Red-Blue Stripe Blue-Red Stripe	15	Black-Gray Stripe Gray-Black Stripe	23	Purple-Green Stripe Green-Purple Stripe
7	Red-Orange Stripe Orange-Red Stripe	16	Yellow-Blue Stripe Blue-Yellow Stripe	24	Purple-Brown Stripe Brown-Purple Stripe
8	Red-Green Stripe Green-Red Stripe	17	Yellow-Orange Stripe Orange-Yellow Stripe	25	Purple-Gray Stripe Gray-Purple Stripe
9	Red-Brown Stripe Brown-Red Stripe				

Single Conductor: Green with Yellow Stripe



Multi-Paired, Individually Foil Shielded

UL 2919, NEC Type CM, CSA CMH

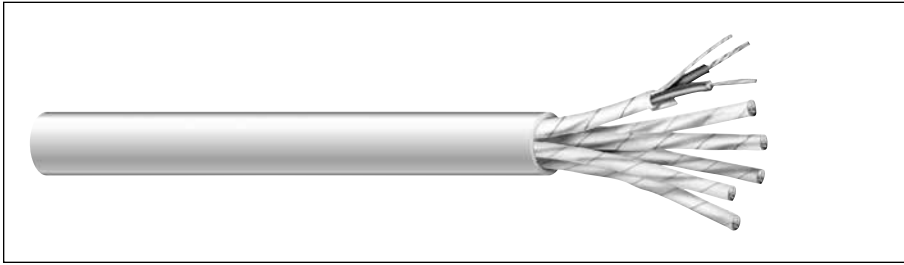

Product Construction:

Conductor:

- 24 thru 18 AWG fully annealed stranded tinned copper per ASTM B33
- Twisted pairs

Insulation:

- Premium-grade, color-coded polyethylene
- Color code: See chart below

Shield:

- Individually shielded pairs
- 100% Flexfoil® aluminum/polyester with 25% overlap, minimum, foil facing in
- Stranded tinned copper drain wire each pair

Jacket:

- PVC, gray
- Temperature range: -20°C to +80°C

Applications:

- Applications for total isolation of signal
- Computers
- Control circuits
- Industrial equipment
- Suggested voltage rating: 30 volts

Compliances:

- NEC Article 800 Type CM (UL: 75°C, 300 V)
- UL Style 2919 (UL: 80°C, 30 V)
- CSA CMH (CSA: 60°C)
- RoHS Compliant Directive 2011/65/EU
- Designed to meet UL 70,000 BTU Vertical Tray Flame Test
- Passes CSA CMH Flame Test
- CE: Low Voltage Directive (LVD) 2006/95/EC

Packaging:

- Please contact Customer Service for packaging and color options

CATALOG NUMBER	NO. OF PAIRS	AWG SIZE	COND. STRAND	NOM. INSULATION THICKNESS		NOM. JACKET THICKNESS		NOMINAL O.D.		NOMINAL DCR Ω/kft		VEL. OF PROP., %	NOM. IMP., Ω	NOMINAL CAP.** pF/ft	
				INCHES	mm	INCHES	mm	INCHES	mm	COND.	SHLD.			A	B
C6065A	3	24	7/32	0.011	0.28	0.032	0.81	0.269	6.83	26.0	18.0	66	71	21.7	39.0
C6066A	6	24	7/32	0.011	0.28	0.032	0.81	0.349	8.86	26.0	18.0	66	71	21.7	39.0
C6067A	9	24	7/32	0.011	0.28	0.032	0.81	0.406	10.31	26.0	18.0	66	71	21.7	39.0
C6040A	3	22	7/30	0.011	0.28	0.032	0.81	0.292	7.42	16.5	11.3	66	63	24.4	43.9
C6041A	6	22	7/30	0.011	0.28	0.032	0.81	0.381	9.68	16.5	11.3	66	63	24.4	43.9
C6042A	9	22	7/30	0.011	0.28	0.032	0.81	0.445	11.30	16.5	11.3	66	63	24.4	43.9
C6043A	11	22	7/30	0.011	0.28	0.032	0.81	0.486	12.34	16.5	11.3	66	63	24.4	43.9
C6059A	12	22	7/30	0.011	0.28	0.048	1.22	0.533	13.54	16.5	11.3	66	63	24.4	43.9
C6044A	15	22	7/30	0.011	0.28	0.048	1.22	0.591	15.01	16.5	11.3	66	63	24.4	43.9
C6060A	17	22	7/30	0.011	0.28	0.048	1.22	0.622	15.80	16.5	11.3	66	63	24.4	43.9
C6045A	19	22	7/30	0.011	0.28	0.048	1.22	0.622	15.80	16.5	11.3	66	63	24.4	43.9
C6046A*	27	22	7/30	0.011	0.28	0.048	1.22	0.696	17.68	16.5	11.3	66	63	24.4	43.9
C6052A	3	20	7/28	0.013	0.33	0.032	0.81	0.339	8.61	10.5	10.2	66	61	25.3	45.6
C6053A	6	20	7/28	0.013	0.33	0.032	0.81	0.446	11.33	10.5	10.2	66	61	25.3	45.6
C6054A	9	20	7/28	0.013	0.33	0.048	1.22	0.555	14.10	10.5	10.2	66	61	25.3	45.6
C6056A	12	20	7/28	0.013	0.33	0.048	1.22	0.623	15.82	10.5	10.2	66	61	25.3	45.6
C6058A	15	20	7/28	0.013	0.33	0.048	1.22	0.692	17.58	10.5	10.2	66	61	25.3	45.6
C6047A	3	18	16/30	0.016	0.41	0.032	0.81	0.395	10.03	7.2	8.3	66	60	25.7	46.2
C6048A	6	18	16/30	0.016	0.41	0.048	1.22	0.556	14.12	7.2	8.3	66	60	25.7	46.2
C6049A	9	18	16/30	0.016	0.41	0.048	1.22	0.649	16.48	7.2	8.3	66	60	25.7	46.2
C6050A	12	18	16/30	0.016	0.41	0.048	1.22	0.731	18.57	7.2	8.3	66	60	25.7	46.2
C6051A	15	18	16/30	0.016	0.41	0.048	1.22	0.776	19.71	7.2	8.3	66	60	25.7	46.2

*UL 2919, CSA CMH Only

**A - Capacitance between conductors

**B - Capacitance between one conductor and other conductors connected to shield

Data subject to change.

Color Code Chart

NO. OF PAIRS	COLOR	NO. OF PAIRS	COLOR	NO. OF PAIRS	COLOR
1	Black paired with Red	10	Red paired with Blue	19	White paired with Blue
2	Black paired with White	11	Red paired with Yellow	20	White paired with Yellow
3	Black paired with Green	12	Red paired with Brown	21	White paired with Brown
4	Black paired with Blue	13	Red paired with Orange	22	White paired with Orange
5	Black paired with Yellow	14	Green paired with White	23	Blue paired with Yellow
6	Black paired with Brown	15	Green paired with Blue	24	Blue paired with Brown
7	Black paired with Orange	16	Green paired with Yellow	25	Blue paired with Orange
8	Red paired with White	17	Green paired with Brown	26	Brown paired with Yellow
9	Red paired with Green	18	Green paired with Orange	27	Brown paired with Orange



Multi-Paired, Individually Foil Shielded, Lo-Cap®

UL 2493, NEC Type CM (UL) c(UL) CMH

Product Construction:

Conductor:

- 24 AWG fully annealed stranded tinned copper per ASTM B33
- Twisted pairs

Insulation:

- Premium-grade, color-coded foamed Lo-Cap® polypropylene
- Color code: See chart below

Shield:

- Individually shielded pairs
- 100% Flexfoil® aluminum/polyester with 25% overlap, minimum, foil facing in
- Stranded tinned copper drain wire each pair

Jacket:

- PVC, gray
- Temperature range: -20°C to +75°C

Applications:

- High-speed computers
- Industrial equipment
- Control circuits
- Suitable for low capacitance applications
- Suitable for EIA RS-422 CAD/CAM applications
- Suggested voltage rating: 300 volts

Compliances:

- NEC Article 800 Type CM/CMH (UL: 75°C, 300 V)
- UL Style 2493 (UL: 60°C)
- RoHS Compliant Directive 2011/65/EU
- Designed to meet UL 70,000 BTU Vertical Tray Flame Test
- CE: Low Voltage Directive (LVD) 2006/95/EC

Packaging:

- Please contact Customer Service for packaging and color options

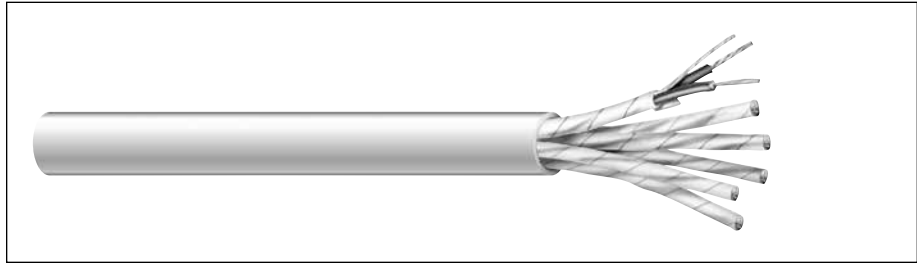

CATALOG NUMBER	NO. OF PAIRS	AWG SIZE	COND. STRAND	NOM. INSULATION THICKNESS		NOM. JACKET THICKNESS		NOMINAL O.D.		NOMINAL DCR Ω/kt		VEL. OF PROP., %	NOM. IMP., Ω	NOMINAL CAP.* pF/ft	
				INCHES	mm	INCHES	mm	INCHES	mm	COND.	SHLD.			A	B
C0910A	2	24	7/32	0.022	0.56	0.047	1.19	0.283	7.19	26.0	18.0	78	100	14.8	26.7
C0911A	3	24	7/32	0.022	0.56	0.048	1.22	0.381	9.68	26.0	18.0	78	100	14.8	26.7
C0912A	4	24	7/32	0.022	0.56	0.048	1.22	0.416	10.57	26.0	18.0	78	100	14.8	26.7
C0913A	6	24	7/32	0.022	0.56	0.048	1.22	0.492	12.50	26.0	18.0	78	100	14.8	26.7
C0914A	9	24	7/32	0.022	0.56	0.063	1.60	0.601	15.27	26.0	18.0	78	100	14.8	26.7
C0915A	11	24	7/32	0.022	0.56	0.063	1.60	0.652	16.56	26.0	18.0	78	100	14.8	26.7
C0916A	12	24	7/32	0.022	0.56	0.063	1.60	0.672	17.08	26.0	18.0	78	100	14.8	26.7
C0917A	15	24	7/32	0.022	0.56	0.063	1.60	0.743	18.87	26.0	18.0	78	100	14.8	26.7

*A – Capacitance between conductors

*B – Capacitance between one conductor and other conductors connected to shield
Data subject to change.

Color Code Chart

NO. OF PAIRS	COLOR	NO. OF PAIRS	COLOR
1	Black paired with Red	9	Red paired with Green
2	Black paired with White	10	Red paired with Blue
3	Black paired with Green	11	Red paired with Yellow
4	Black paired with Blue	12	Red paired with Brown
5	Black paired with Yellow	13	Red paired with Orange
6	Black paired with Brown	14	Green paired with White
7	Black paired with Orange	15	Green paired with Blue
8	Red paired with White		

Multi-Paired, Individually Foil/Braid Shielded, Lo-Cap®

UL 2493, NEC Type CM (UL) c(UL) CMH

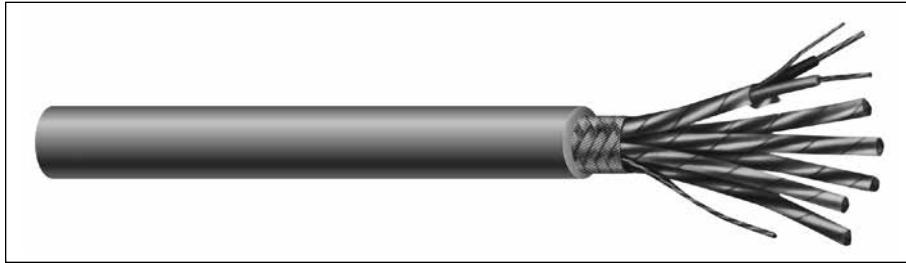

CATALOG NUMBER	NO. OF PAIRS	AWG SIZE	COND. STRAND	NOM. INSULATION THICKNESS		NOM. JACKET THICKNESS		NOMINAL O.D.		NOMINAL DCR**			VEL. OF PROP., %	NOM. IMP., Ω	NOMINAL CAP.*	
				INCHES	mm	INCHES	mm	INCHES	mm	C	D	E			A	B
C0924A	2	24	7/32	0.022	0.56	0.048	1.22	0.392	9.96	26.0	18.0	4.3	78	100	14.8	26.7
C0925A	3	24	7/32	0.022	0.56	0.048	1.22	0.410	10.41	26.0	18.0	4.4	78	100	14.8	26.7
C0926A	4	24	7/32	0.022	0.56	0.048	1.22	0.445	11.30	26.0	18.0	3.2	78	100	14.8	26.7

*A – Capacitance between conductors
 *B – Capacitance between one conductor and other conductors connected to shield
 **C – Conductor resistance
 **D – Individual shield resistance
 **E – Overall shield resistance
 Data subject to change.

Color Code Chart

NO. OF PAIRS	COLOR
1	Black paired with Red
2	Black paired with White
3	Black paired with Green
4	Black paired with Blue

Product Construction:

Conductor:

- 24 AWG fully annealed stranded tinned copper per ASTM B33
- Twisted pairs

Insulation:

- Premium-grade, color-coded foamed Lo-Cap® polypropylene
- Color code: See chart below

Shield:

- Individually shielded pairs
- 100% Flexfoil® aluminum/polyester with 25% overlap, minimum, foil facing in
- Stranded tinned copper drain wire, each pair
- 70% tinned copper braid

Jacket:

- PVC, gray
- Temperature range: -20°C to +75°C

Applications:

- High-speed computers
- Industrial equipment
- Control circuits
- Designed for low capacitance applications
- Suitable for RS-422 CAD/CAM applications
- Suggested voltage rating: 300 volts

Compliances:

- NEC Article 800 Type CM/CMH (UL: 75°C, 300 V)
- UL Style 2493 (UL: 60°C)
- RoHS Compliant Directive 2011/65/EU
- Designed to meet UL 70,000 BTU Vertical Tray Flame Test
- CE: Low Voltage Directive (LVD) 2006/95/EC

Packaging:

- Please contact Customer Service for packaging and color options



Designed to Meet
UL Vertical Tray
Flame Test

Underwriters Laboratories Inc.



EXZEL® High-Endurance Cables

4



As a full electronics solutions provider with a commitment to designing innovative cable constructions, General Cable recognizes the growing demand for a higher performance line of electronic wire and cable to support emerging technology, mission-critical applications and today's environmental concerns. That's why we've introduced a new, tougher addition to the Carol® Brand family – EXZEL High-Endurance Electronic Cables.

General Cable's new EXZEL High-Endurance Electronic Cables are engineered for extreme environments where unparalleled performance is critical and cable failures are not an option. An exceptional choice that offers complete peace of mind, this new cabling line *exzels* in applications where oil, liquids, vapors or other substances can attack the jacketing of conventional "round gray" PVC electronic cables. Along with improved jacketing performance, EXZEL's innovative Dual Foil/Braid Shield technology provides more effective shielding. This dual-foil design with 85% copper-braid coverage significantly reduces electromagnetic and radio frequency interference (EMI/RFI) over traditional single-foil tape designs.

In response to environmental concern surrounding the burning of halogens, General Cable also offers the Low-Smoke, Zero-Halogen (LSZH) line of EXZEL High-Endurance Electronic Cables. To reduce the toxicity and corrosive effects that may impact people and equipment, Carol Brand's EXZEL LSZH construction produces low amounts of smoke and acid gas during a fire, while maintaining the same flame requirements, electrical performance and longevity as traditional cable constructions.

Whether you are involved with a green building installation or simply looking for ways to safeguard people and protect the environment, EXZEL High-Endurance Electronic Cables provide a true "green" alternative. And with EXZEL, U.S. manufacturers now have access to a domestic LSZH cable solution required for use on equipment that may be sold internationally.

Index	Page
Carol Brand EXZEL Guide	78-80
Multi-Conductor, Unshielded	81
Multi-Conductor, Foil Shielded	82
Multi-Conductor, Foil/Braid Shielded	83
Multi-Paired, Unshielded	84
Multi-Paired, Foil Shielded	85
Multi-Paired, Foil/Braid Shielded	86
Multi-Conductor, Unshielded, Heavy Duty	87
Multi-Conductor, Foil Shielded, Heavy Duty	88
Multi-Conductor, Foil/Braid Shielded, Heavy Duty	89
Multi-Paired, Foil/Braid Shielded, Heavy Duty	90
LSZH Multi-Conductor, Unshielded	91
LSZH Multi-Conductor, Foil Shielded	92
LSZH Multi-Conductor, Foil/Braid Shielded	93
LSZH Multi-Paired, Unshielded	94
LSZH Multi-Paired, Foil Shielded	95
LSZH Multi-Paired, Foil/Braid Shielded	96
Color Code Charts	97

Carol[®] Brand EXZEL[®] Complete Peace of Mind

READY TO SERVE

For more than 60 years, General Cable has met the ever-changing needs of major Original Equipment Manufacturers (OEMs) and the most demanding, high-volume bulk requirements of Maintenance Repair Operations (MROs), as well as smaller, niche OEMs around the world. Uniquely qualified to provide superior engineering, products and value-added services, General Cable's customers represent a virtual "who's who" of the industries we serve. All Carol[®] Brand's EXZEL[®] High-Endurance Electronic Cables are ideal for use in the following markets and applications:

Manufacturing

- Device communications
- Control interconnect
- PLC networking
- Industrial machinery

Food and Beverage

- Meat and food processing
- Bottling plants
- Packaging machines

Semiconductor

- Robotic handling systems
- Class I, Division 2
- Automated test equipment
- Wafer processing equipment

Utilities

- Wastewater treatment plants
- Wind turbine control
- Gas delivery communications

Military

- Mobile communications
- Avionics control

Process

- Remote monitoring
- Discrete/analog signaling

Medical Diagnostics

- Digital imaging control
- Biomedical

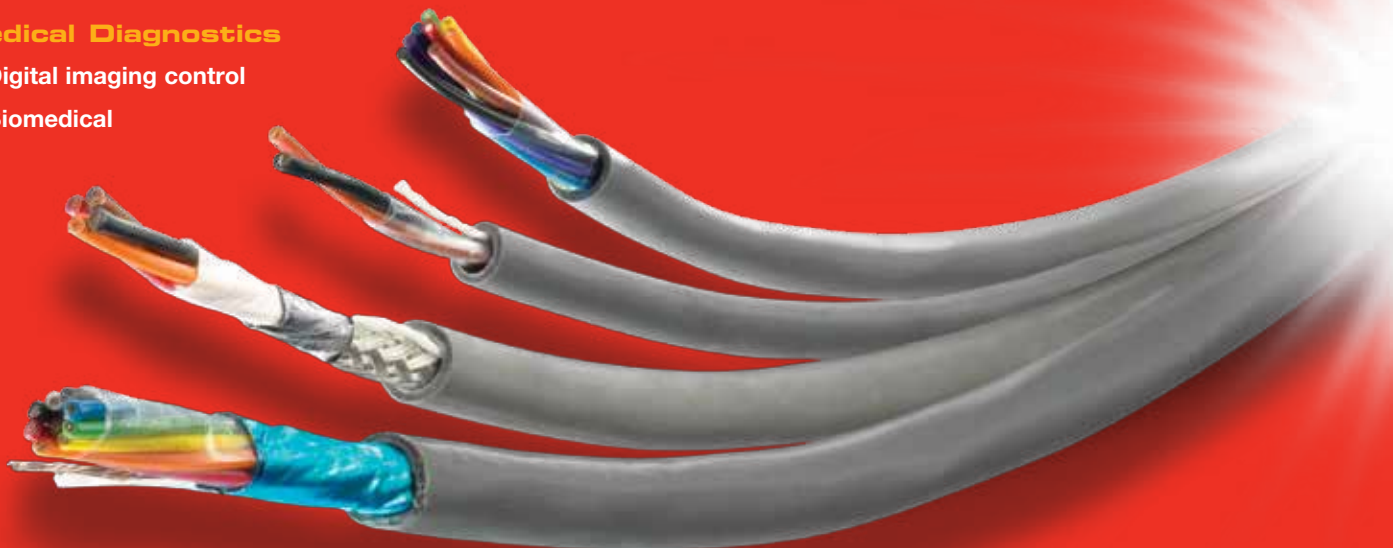

BACKED BY QUALITY

EXZEL[®] High-Endurance Electronic Cables are manufactured with the selection, quality and dependability our customers have come to expect from Carol[®] Brand cables. From special jacket colors, print legends and TRU-Mark[®] sequential footage markings to unique constructions, innovative materials and quality manufacturing, General Cable's expert engineers offer superior service and design assistance. Most of our products carry UL, ETL, RoHS, CSA and other major approvals from around the globe.

Need a specific construction not available in our standard stock? We have you covered. General Cable will customize any standard EXZEL cable construction to meet your unique application requirements, including:

- Jacket colors
- Gauge sizes
- Conductor count and construction
- Insulation and jacket construction
- Shielding options
- Armoring
- Composites

EXZEL's LSZH cables, as well as all of our High-Endurance cables, are manufactured in General Cable's Franklin, Massachusetts and Manchester, New Hampshire facilities — both of which are recognized among North America's Top 10 Best Manufacturing Plants by *INDUSTRYWEEK* Magazine.

When exceptional performance and reliability are critical to your application, put your trust in Carol Brand EXZEL.

Comparison of Traditional Round Gray Electronic Cables to EXZEL High-Endurance Electronic Cables

	Traditional Round Gray Electronic Cables	EXZEL PVC	EXZEL LSZH
Conductor Type	Tinned Copper	Tinned Copper	Tinned Copper
Conductor Strand	7/XX	Flexible	Flexible
Insulation	PVC	PVC	LSZH
Shielding	Limited	Full	Full
Braid Coverage	70	70	85
Jacket	PVC	PVC	LSZH
Footage Markings	No	TRU-Mark	Yes
Temp Rating	80°C	105°C	105°C
Oil Resistance	No	No	OR I*
UV Resistance	No	Yes	Yes
NEC/UL Type CM	Yes (80°C)	Yes (105°C)	Yes
UL AWM	Style 2464	Style 2464	N/A
CSA CMG	Yes (80°C)	Yes (105°C)	No
UL PLTC-ER	No	No	Yes
PLTC	No	No	Yes
UL Flame Rating	UL 1581	UL 1581	UL 1581
CSA Flame Rating	FT4	FT4	FT4

*OR I = UL Oil Resistance I

FEATURES AND BENEFITS OF CAROL® BRAND EXZEL®

- Reduced downtime for lower cost of ownership
- Superior reliability, even in the harshest environments
- Extensive selection to meet application needs
- Optimum lifespan in severe operating conditions
- Highest available shield coverage for maximum EMI/RFI resistance
- Low-Smoke, Zero-Halogen constructions available
- Premium-grade PVC insulation and jacket available for routing in tight spaces
- Resistant to most oils (UL Class 43) and to ambient temperatures up to 105°C

SURFACE TRANSFER IMPEDANCES (STI)

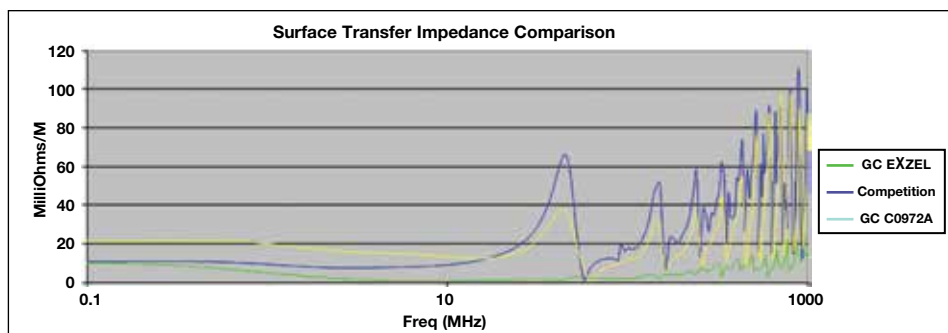

Why General Cable?

Unrivaled service. Unparalleled innovation. Unmatched industry leadership.

At General Cable, we believe quality is what we put in your product. That's why we employ a LeanSigma management philosophy that eliminates waste and non-value-added processes to improve the flow of information and materials. Always searching for new and better ways of doing things, General Cable consistently identifies and eliminates sources of variation while reducing cycle time and inventory, ensuring better capacity and space utilization and improving productivity. We have the right mix of people, equipment and experience to produce custom cables, wire harnesses and cable assemblies of the highest complexity and quality – High-Endurance Electronic products that *exzel!*

- **Certified ISO 9001 manufacturing facilities**
- **Rigorous performance standards**
- **Ongoing R&D for an ever-growing range of materials**
- **Superior materials and proactive prevention**
- **Comprehensive process control and quality audits**
- **Stringent in-house and third-party testing**

General Cable is an environmentally conscious company committed to reducing and, where possible, eliminating hazardous substances. Our facilities have fully implemented an ISO 14001-equivalent environmental management system with strict oversight to ensure that regulatory compliance is met or exceeded. All applicable products are certified or are being upgraded to meet RoHS standards, and we are working to comply with evolving REACH requirements as they pertain to wire and cable products and materials.

THE BOTTOM LINE

General Cable recognizes and values the vital importance of total, exceptional customer satisfaction, and we have the experience and know-how to achieve it. Our people may come to work for us, but on the job, our *Wire Wizards* work for you. Put us to work and see what we can do for you.

EXZEL® Multi-Conductor, Unshielded

UL 2464, NEC Type CM (UL), CSA CMG

Product Construction:

Conductor:

- Fully annealed stranded tinned copper per ASTM B33

Insulation:

- Premium-grade, color-coded PVC
- Color per Chart A for 24 AWG and 22 AWG on page 97
- Color per Chart B for 20 AWG and larger on page 97
- International colors per IEC Color Chart on page 97

Shield:

- Unshielded

Jacket:

- Premium PVC
- Operating temperature range: -30°C to +105°C (Type CM) -30°C to +80°C (AWM)

Applications:

- Advanced signal transmission in controlled environments
- Medical instrumentation and equipment
- Consumer electronic peripherals
- Industrial process control systems
- Suitable for EIA RS-232 applications

Features:

- Oil-resistant per UL Oil Res I and Class 43
- Sunlight-resistant per UL 720-hr. UV test
- Nylon ripcord

Compliances:

- NEC Article 800 Type CM (UL: 105°C)
- UL Style 2464 (UL: 80°C, 300 V, VW-1)
- CSA Type CMG (CSA: 105°C, FT4)
- CE: Low-Voltage Directive (LVD) 2006/95/EC
- RoHS Compliant Directive 2011/65/EU
- Vertical Tray Cable Flame Test per UL 1581 and IEEE 383 (70,000 BTU)

Packaging

- Please contact Customer Service for packaging and color options

Data subject to change.

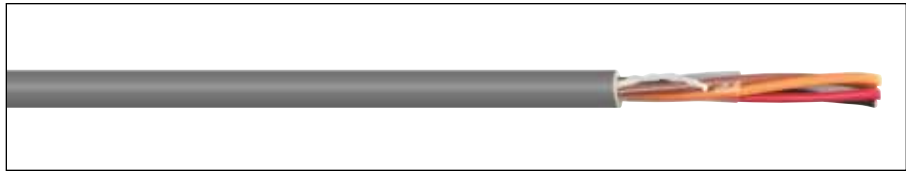

PART NUMBER	COND.	AWG SIZE	COND. STRAND	NOMINAL INSULATION THICKNESS		NOMINAL JACKET THICKNESS		NOMINAL CABLE DIAMETER	
				INCHES	mm	INCHES	mm	INCHES	mm
C9000A	2	24	7/32	0.010	0.25	0.032	0.81	0.155	3.94
C9001A	3	24	7/32	0.010	0.25	0.032	0.81	0.161	4.10
C9002A	4	24	7/32	0.010	0.25	0.032	0.81	0.173	4.40
C9003A	6	24	7/32	0.010	0.25	0.032	0.81	0.198	5.03
C9004A	8	24	7/32	0.010	0.25	0.032	0.81	0.211	5.37
C9005A	10	24	7/32	0.010	0.25	0.032	0.81	0.241	6.12
C9006A	15	24	7/32	0.010	0.25	0.032	0.81	0.271	6.89
C9007A	20	24	7/32	0.010	0.25	0.032	0.81	0.297	7.55
C9008A	25	24	7/32	0.010	0.25	0.032	0.81	0.327	8.31
C9009A	2	22	7/30	0.010	0.25	0.032	0.81	0.167	4.24
C9010A	3	22	7/30	0.010	0.25	0.032	0.81	0.174	4.43
C9011A	4	22	7/30	0.010	0.25	0.032	0.81	0.188	4.76
C9012A	6	22	7/30	0.010	0.25	0.032	0.81	0.216	5.49
C9013A	8	22	7/30	0.010	0.25	0.032	0.81	0.231	5.87
C9014A	10	22	7/30	0.010	0.25	0.032	0.81	0.265	6.73
C9015A	15	22	7/30	0.010	0.25	0.032	0.81	0.299	7.60
C9016A	20	22	7/30	0.010	0.25	0.032	0.81	0.329	8.36
C9017A	25	22	7/30	0.010	0.25	0.032	0.81	0.363	9.22
C9018A	2	20	7/28	0.016	0.41	0.032	0.81	0.205	5.21
C9019A	3	20	7/28	0.016	0.41	0.032	0.81	0.215	5.47
C9020A	4	20	7/28	0.016	0.41	0.032	0.81	0.234	5.93
C9021A	6	20	7/28	0.016	0.41	0.032	0.81	0.273	6.93
C9022A	8	20	7/28	0.016	0.41	0.032	0.81	0.294	7.47
C9023A	10	20	7/28	0.016	0.41	0.032	0.81	0.341	8.66
C9024A	15	20	7/28	0.016	0.41	0.032	0.81	0.389	9.87
C9025A	20	20	7/28	0.016	0.41	0.032	0.81	0.430	10.92
C9026A	25	20	7/28	0.016	0.41	0.032	0.81	0.477	12.12
C9027A*	2	18	16/30	0.016	0.41	0.032	0.81	0.225	5.72
C9028A	2	18	16/30	0.016	0.41	0.032	0.81	0.225	5.72
C9029A*	3	18	16/30	0.016	0.41	0.032	0.81	0.237	6.01
C9030A	3	18	16/30	0.016	0.41	0.032	0.81	0.237	6.01
C9031A	4	18	16/30	0.016	0.41	0.032	0.81	0.258	6.55
C9032A	6	18	16/30	0.016	0.41	0.032	0.81	0.303	7.70
C9033A	8	18	16/30	0.016	0.41	0.032	0.81	0.327	8.31
C9034A	10	18	16/30	0.016	0.41	0.032	0.81	0.381	9.68
C9035A	15	18	16/30	0.016	0.41	0.032	0.81	0.436	11.06
C9036A	20	18	16/30	0.016	0.41	0.032	0.81	0.483	12.27
C9037A	25	18	16/30	0.016	0.41	0.032	0.81	0.537	13.64
C9038A*	2	16	19/.0117	0.016	0.41	0.032	0.81	0.245	6.22
C9039A	2	16	19/.0117	0.016	0.41	0.032	0.81	0.245	6.22
C9040A*	3	16	19/.0117	0.016	0.41	0.032	0.81	0.258	6.56
C9041A	3	16	19/.0117	0.016	0.41	0.032	0.81	0.258	6.56
C9042A	4	16	19/.0117	0.016	0.41	0.032	0.81	0.282	7.16
C9043A	6	16	19/.0117	0.016	0.41	0.032	0.81	0.333	8.46
C9044A	8	16	19/.0117	0.016	0.41	0.032	0.81	0.360	9.15
C9045A	10	16	19/.0117	0.016	0.41	0.032	0.81	0.421	10.69
C9046A	15	16	19/.0117	0.016	0.41	0.032	0.81	0.483	12.26
C9047A	20	16	19/.0117	0.016	0.41	0.053	1.35	0.578	14.69
C9048A	25	16	19/.0117	0.016	0.41	0.053	1.35	0.639	16.23

* IEC Color Code: Brown, Blue, Green/Yellow



EXZEL® Multi-Conductor, Foil Shielded

UL 2464, NEC Type CM (UL), CSA CMG

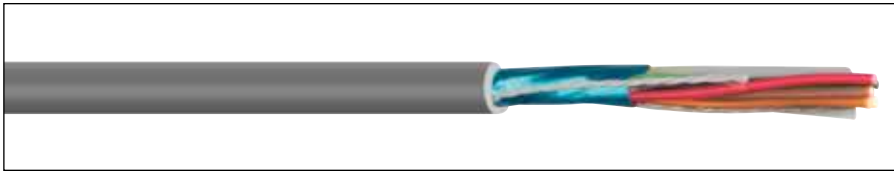

PART NUMBER	COND.	AWG SIZE	COND. STRAND	NOMINAL INSULATION THICKNESS		NOMINAL JACKET THICKNESS		NOMINAL CABLE DIAMETER	
				INCHES	mm	INCHES	mm	INCHES	mm
C9100A	2	24	7/32	0.010	0.25	0.032	0.81	0.157	3.99
C9101A	3	24	7/32	0.010	0.25	0.032	0.81	0.163	4.15
C9102A	4	24	7/32	0.010	0.25	0.032	0.81	0.175	4.45
C9103A	6	24	7/32	0.010	0.25	0.032	0.81	0.200	5.08
C9104A	8	24	7/32	0.010	0.25	0.032	0.81	0.213	5.42
C9105A	10	24	7/32	0.010	0.25	0.032	0.81	0.243	6.17
C9106A	15	24	7/32	0.010	0.25	0.032	0.81	0.273	6.94
C9107A	20	24	7/32	0.010	0.25	0.032	0.81	0.299	7.60
C9108A	25	24	7/32	0.010	0.25	0.032	0.81	0.329	8.36
C9109A	2	22	7/30	0.010	0.25	0.032	0.81	0.169	4.29
C9110A	3	22	7/30	0.010	0.25	0.032	0.81	0.176	4.48
C9111A	4	22	7/30	0.010	0.25	0.032	0.81	0.190	4.82
C9112A	6	22	7/30	0.010	0.25	0.032	0.81	0.218	5.54
C9113A	8	22	7/30	0.010	0.25	0.032	0.81	0.233	5.92
C9114A	10	22	7/30	0.010	0.25	0.032	0.81	0.267	6.78
C9115A	15	22	7/30	0.010	0.25	0.032	0.81	0.301	7.65
C9116A	20	22	7/30	0.010	0.25	0.032	0.81	0.331	8.41
C9117A	25	22	7/30	0.010	0.25	0.032	0.81	0.365	9.27
C9118A	2	20	7/28	0.016	0.41	0.032	0.81	0.207	5.26
C9119A	3	20	7/28	0.016	0.41	0.032	0.81	0.217	5.52
C9120A	4	20	7/28	0.016	0.41	0.032	0.81	0.236	5.98
C9121A	6	20	7/28	0.016	0.41	0.032	0.81	0.275	6.99
C9122A	8	20	7/28	0.016	0.41	0.032	0.81	0.296	7.52
C9123A	10	20	7/28	0.016	0.41	0.032	0.81	0.343	8.71
C9124A	15	20	7/28	0.016	0.41	0.032	0.81	0.391	9.92
C9125A	20	20	7/28	0.016	0.41	0.032	0.81	0.432	10.97
C9126A	25	20	7/28	0.016	0.41	0.032	0.81	0.479	12.17
C9127A	2	18	16/30	0.016	0.41	0.032	0.81	0.227	5.77
C9128A*	2	18	16/30	0.016	0.41	0.032	0.81	0.227	5.77
C9129A	3	18	16/30	0.016	0.41	0.032	0.81	0.239	6.06
C9130A*	3	18	16/30	0.016	0.41	0.032	0.81	0.239	6.06
C9131A	4	18	16/30	0.016	0.41	0.032	0.81	0.260	6.60
C9132A	6	18	16/30	0.016	0.41	0.032	0.81	0.305	7.75
C9133A	8	18	16/30	0.016	0.41	0.032	0.81	0.329	8.36
C9134A	10	18	16/30	0.016	0.41	0.032	0.81	0.383	9.73
C9135A	15	18	16/30	0.016	0.41	0.032	0.81	0.438	11.12
C9136A	20	18	16/30	0.016	0.41	0.032	0.81	0.485	12.32
C9137A	25	18	16/30	0.016	0.41	0.032	0.81	0.539	13.69
C9138A	2	16	19/.0117	0.016	0.41	0.032	0.81	0.247	6.27
C9139A*	2	16	19/.0117	0.016	0.41	0.032	0.81	0.247	6.27
C9140A	3	16	19/.0117	0.016	0.41	0.032	0.81	0.260	6.61
C9141A*	3	16	19/.0117	0.016	0.41	0.032	0.81	0.260	6.61
C9142A	4	16	19/.0117	0.016	0.41	0.032	0.81	0.284	7.21
C9143A	6	16	19/.0117	0.016	0.41	0.032	0.81	0.335	8.51
C9144A	8	16	19/.0117	0.016	0.41	0.032	0.81	0.362	9.20
C9145A	10	16	19/.0117	0.016	0.41	0.032	0.81	0.423	10.74
C9146A	15	16	19/.0117	0.016	0.41	0.032	0.81	0.485	12.31
C9147A	20	16	19/.0117	0.016	0.41	0.053	1.35	0.580	14.74
C9148A	25	16	19/.0117	0.016	0.41	0.053	1.35	0.641	16.28

* IEC Color Code: Brown, Blue, Green/Yellow

Product Construction:

Conductor:

- Fully annealed stranded tinned copper per ASTM B33

Insulation:

- Premium-grade, color-coded PVC
- Color per Chart A for 24 AWG and 22 AWG on page 97
- Color per Chart B for 20 AWG and larger on page 97
- International colors per IEC Color Chart on page 97

Shield:

- 100% Flexfoil® aluminum/polyester, foil facing in
- Stranded tinned copper drain wire

Jacket:

- Premium PVC
- Operating temperature range: -30°C to +105°C (Type CM) -30°C to +80°C (AWM)

Applications:

- Advanced signal transmission in controlled environments
- Medical instrumentation and equipment
- Consumer electronic peripherals
- Industrial process control systems
- Suitable for EIA RS-232 applications

Features:

- Oil-resistant per UL Oil Res I and Class 43
- Sunlight-resistant per UL 720-hr. UV test
- Nylon ripcord

Compliances:

- NEC Article 800 Type CM (UL: 105°C)
- UL Style 2464 (UL: 80°C, 300 V, VW-1)
- CSA Type CMG (CSA: 105°C, FT4)
- CE: Low-Voltage Directive (LVD) 2006/95/EC
- RoHS Compliant Directive 2011/65/EU
- Vertical Tray Cable Flame Test per UL 1581 and IEEE 383 (70,000 BTU)

Packaging

- Please contact Customer Service for packaging and color options

Data subject to change.



EXZEL® Multi-Conductor, Foil/Braid Shielded

UL 2464, NEC Type CM (UL), CSA CMG

Product Construction:

Conductor:

- Fully annealed stranded tinned copper per ASTM B33

Insulation:

- Premium-grade, color-coded PVC
- Color per Chart A for 24 AWG and 22 AWG on page 97
- Color per Chart B for 20 AWG and larger on page 97
- International colors per IEC Color Chart on page 97

Shield:

- Dual foil with overall braided shield
- Aluminum/polyester/aluminum foil with 100% coverage
- Stranded tinned copper drain wire
- Tinned copper braided shield, 70% min coverage

Jacket:

- Premium PVC
- Operating temperature range: -30°C to +105°C (Type CM) -30°C to +80°C (AWM)

Applications:

- Advanced signal transmission in controlled environments
- Medical instrumentation and equipment
- Consumer electronic peripherals
- Industrial process control systems
- Suitable for EIA RS-232 applications

Features:

- Oil-resistant per UL Oil Res I and Class 43
- Sunlight-resistant
- Nylon ripcord

Compliances:

- NEC Article 800 Type CM (UL: 105°C)
- UL Style 2464 (UL: 80°C, 300 V, VW-1)
- CSA Type CMG (CSA: 105°C, FT4)
- CE: Low-Voltage Directive (LVD) 2006/95/EC
- RoHS Compliant Directive 2011/65/EU
- Vertical Tray Cable Flame Test per UL 1581 and IEEE 383 (70,000 BTU)

Packaging

- Please contact Customer Service for packaging and color options

Data subject to change.

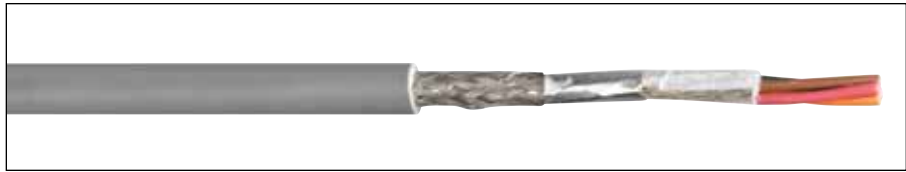

PART NUMBER	COND.	AWG SIZE	COND. STRAND	NOMINAL INSULATION THICKNESS		NOMINAL JACKET THICKNESS		NOMINAL CABLE DIAMETER	
				INCHES	mm	INCHES	mm	INCHES	mm
C9200A	2	24	7/32	0.010	0.25	0.032	0.81	0.184	4.67
C9201A	3	24	7/32	0.010	0.25	0.032	0.81	0.190	4.84
C9202A	4	24	7/32	0.010	0.25	0.032	0.81	0.202	5.13
C9203A	6	24	7/32	0.010	0.25	0.032	0.81	0.227	5.77
C9204A	8	24	7/32	0.010	0.25	0.032	0.81	0.240	6.10
C9205A	10	24	7/32	0.010	0.25	0.032	0.81	0.270	6.86
C9206A	15	24	7/32	0.010	0.25	0.032	0.81	0.300	7.62
C9207A	20	24	7/32	0.010	0.25	0.032	0.81	0.326	8.29
C9208A	25	24	7/32	0.010	0.25	0.032	0.81	0.356	9.04
C9209A	2	22	7/30	0.010	0.25	0.032	0.81	0.196	4.98
C9210A	3	22	7/30	0.010	0.25	0.032	0.81	0.203	5.17
C9211A	4	22	7/30	0.010	0.25	0.032	0.81	0.217	5.50
C9212A	6	22	7/30	0.010	0.25	0.032	0.81	0.245	6.22
C9213A	8	22	7/30	0.010	0.25	0.032	0.81	0.260	6.61
C9214A	10	22	7/30	0.010	0.25	0.032	0.81	0.294	7.47
C9215A	15	22	7/30	0.010	0.25	0.032	0.81	0.328	8.34
C9216A	20	22	7/30	0.010	0.25	0.032	0.81	0.358	9.10
C9217A	25	22	7/30	0.010	0.25	0.032	0.81	0.392	9.96
C9218A	2	20	7/28	0.016	0.41	0.032	0.81	0.234	5.94
C9219A	3	20	7/28	0.016	0.41	0.032	0.81	0.244	6.20
C9220A	4	20	7/28	0.016	0.41	0.032	0.81	0.263	6.67
C9221A	6	20	7/28	0.016	0.41	0.032	0.81	0.302	7.67
C9222A	8	20	7/28	0.016	0.41	0.032	0.81	0.323	8.21
C9223A	10	20	7/28	0.016	0.41	0.032	0.81	0.370	9.40
C9224A	15	20	7/28	0.016	0.41	0.032	0.81	0.418	10.61
C9225A	20	20	7/28	0.016	0.41	0.032	0.81	0.459	11.66
C9226A	25	20	7/28	0.016	0.41	0.032	0.81	0.506	12.85
C9227A*	2	18	16/30	0.016	0.41	0.032	0.81	0.254	6.45
C9228A	2	18	16/30	0.016	0.41	0.032	0.81	0.254	6.45
C9229A*	3	18	16/30	0.016	0.41	0.032	0.81	0.266	6.75
C9230A	3	18	16/30	0.016	0.41	0.032	0.81	0.266	6.75
C9231A	4	18	16/30	0.016	0.41	0.032	0.81	0.287	7.28
C9232A	6	18	16/30	0.016	0.41	0.032	0.81	0.332	8.43
C9233A	8	18	16/30	0.016	0.41	0.032	0.81	0.356	9.05
C9234A	10	18	16/30	0.016	0.41	0.032	0.81	0.410	10.41
C9235A	15	18	16/30	0.016	0.41	0.032	0.81	0.465	11.80
C9236A	20	18	16/30	0.016	0.41	0.032	0.81	0.512	13.01
C9237A	25	18	16/30	0.016	0.41	0.032	0.81	0.566	14.38
C9238A*	2	16	19/.0117	0.016	0.41	0.032	0.81	0.274	6.96
C9239A	2	16	19/.0117	0.016	0.41	0.032	0.81	0.274	6.96
C9240A*	3	16	19/.0117	0.016	0.41	0.032	0.81	0.287	7.29
C9241A	3	16	19/.0117	0.016	0.41	0.032	0.81	0.287	7.29
C9242A	4	16	19/.0117	0.016	0.41	0.032	0.81	0.311	7.90
C9243A	6	16	19/.0117	0.016	0.41	0.032	0.81	0.362	9.19
C9244A	8	16	19/.0117	0.016	0.41	0.032	0.81	0.389	9.89
C9245A	10	16	19/.0117	0.016	0.41	0.032	0.81	0.450	11.43
C9246A	15	16	19/.0117	0.016	0.41	0.032	0.81	0.512	12.99
C9247A	20	16	19/.0117	0.016	0.41	0.053	1.35	0.607	15.42
C9248A	25	16	19/.0117	0.016	0.41	0.053	1.35	0.679	17.25

* IEC Color Code: Brown, Blue, Green/Yellow



EXZEL® Multi-Paired, Unshielded

UL 2464, NEC Type CM (UL), CSA CMG

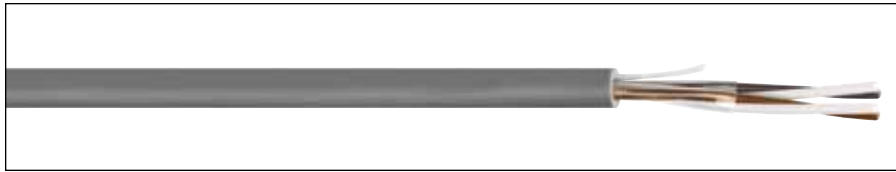

PART NUMBER	PAIRS	AWG SIZE	COND. STRAND	NOMINAL INSULATION THICKNESS		NOMINAL JACKET THICKNESS		NOMINAL CABLE DIAMETER	
				INCHES	mm	INCHES	mm	INCHES	mm
C9300A	1	24	7/32	0.010	0.25	0.032	0.81	0.155	3.94
C9301A	2	24	7/32	0.010	0.25	0.032	0.81	0.211	5.37
C9302A	3	24	7/32	0.010	0.25	0.032	0.81	0.222	5.64
C9303A	4	24	7/32	0.010	0.25	0.032	0.81	0.242	6.13
C9304A	5	24	7/32	0.010	0.25	0.032	0.81	0.262	6.65
C9305A	6	24	7/32	0.010	0.25	0.032	0.81	0.283	7.20
C9306A	9	24	7/32	0.010	0.25	0.032	0.81	0.327	8.31
C9307A	11	24	7/32	0.010	0.25	0.032	0.81	0.355	9.03
C9308A	15	24	7/32	0.010	0.25	0.032	0.81	0.406	10.31
C9309A	1	22	7/30	0.010	0.25	0.032	0.81	0.149	3.79
C9310A	2	22	7/30	0.010	0.25	0.032	0.81	0.231	5.88
C9311A	3	22	7/30	0.010	0.25	0.032	0.81	0.244	6.19
C9312A	4	22	7/30	0.010	0.25	0.032	0.81	0.266	6.75
C9313A	5	22	7/30	0.010	0.25	0.032	0.81	0.289	7.34
C9314A	6	22	7/30	0.010	0.25	0.032	0.81	0.314	7.96
C9315A	15	22	7/30	0.010	0.25	0.032	0.81	0.453	11.51
C9316A	2	20	7/28	0.016	0.41	0.032	0.81	0.295	7.49
C9317A	3	20	7/28	0.016	0.41	0.032	0.81	0.312	7.93
C9318A	6	20	7/28	0.016	0.41	0.032	0.81	0.409	10.39
C9319A	9	20	7/28	0.016	0.41	0.032	0.81	0.479	12.16
C9320A	12	20	7/28	0.016	0.41	0.032	0.81	0.540	13.72
C9321A	2	18	16/30	0.016	0.41	0.032	0.81	0.329	8.35
C9322A	3	18	16/30	0.016	0.41	0.032	0.81	0.348	8.85
C9323A	6	18	16/30	0.016	0.41	0.032	0.81	0.459	11.67
C9324A	9	18	16/30	0.016	0.41	0.032	0.81	0.539	13.70
C9325A	12	18	16/30	0.016	0.41	0.053	1.35	0.652	16.56

Product Construction:

Conductor:

- Fully annealed stranded tinned copper per ASTM B33

Insulation:

- Premium-grade, color-coded PVC
- Color per Chart C for 24 AWG and 22 AWG on page 97
- Color per Chart D for 20 AWG and larger on page 97

Shield:

- Unshielded

Jacket:

- Premium PVC
- Operating temperature range: -30°C to +105°C (Type CM) -30°C to +80°C (AWM)

Applications:

- Advanced signal transmission in controlled environments
- Medical instrumentation and equipment
- Consumer electronic peripherals
- Industrial process control systems
- Suitable for EIA RS-232 applications

Features:

- Oil-resistant per UL Oil Res I and Class 43
- Sunlight-resistant
- Nylon ripcord

Compliances:

- NEC Article 800 Type CM (UL: 105°C)
- UL Style 2464 (UL: 80°C, 300 V, VW-1)
- CSA Type CMG (CSA: 105°C, FT4)
- CE: Low-Voltage Directive (LVD) 2006/95/EC
- RoHS Compliant Directive 2011/65/EU
- Vertical Tray Cable Flame Test per UL 1581 and IEEE 383 (70,000 BTU)

Packaging

- Please contact Customer Service for packaging and color options

Data subject to change.



EXZEL® Multi-Paired, Foil Shielded

UL 2464, NEC Type CM (UL), CSA CMG

Product Construction:**Conductor:**

- Fully annealed stranded tinned copper per ASTM B33

Insulation:

- Premium-grade, color-coded PVC
- Color per Chart C for 24 AWG and 22 AWG on page 97
- Color per Chart D for 20 AWG and larger on page 97

Shield:

- 100% Flexfoil® aluminum/polyester, foil facing in
- Stranded tinned copper drain wire

Jacket:

- Premium PVC
- Operating temperature range:
-30°C to +105°C (Type CM)
-30°C to +80°C (AWM)

Applications:

- Advanced signal transmission in controlled environments
- Medical instrumentation and equipment
- Consumer electronic peripherals
- Industrial process control systems
- Suitable for EIA RS-232 applications

Features:

- Oil-resistant per UL Oil Res I and Class 43
- Sunlight-resistant
- Nylon ripcord

Compliances:

- NEC Article 800 Type CM (UL: 105°C)
- UL Style 2464 (UL: 80°C, 300 V, VW-1)
- CSA Type CMG (CSA: 105°C, FT4)
- CE: Low-Voltage Directive (LVD) 2006/95/EC
- RoHS Compliant Directive 2011/65/EU
- Vertical Tray Cable Flame Test per UL 1581 and IEEE 383 (70,000 BTU)

Packaging

- Please contact Customer Service for packaging and color options

Data subject to change.

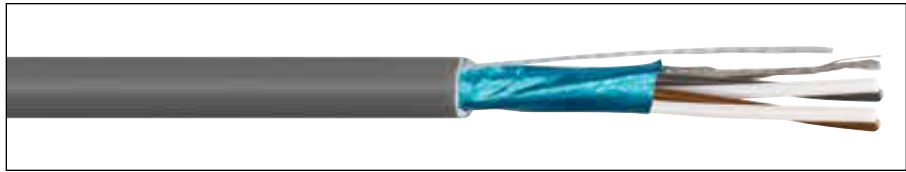

PART NUMBER	PAIRS	AWG SIZE	COND. STRAND	NOMINAL INSULATION THICKNESS		NOMINAL JACKET THICKNESS		NOMINAL CABLE DIAMETER	
				INCHES	mm	INCHES	mm	INCHES	mm
C9400A	1	24	7/32	0.010	0.25	0.032	0.81	0.157	3.99
C9401A	2	24	7/32	0.010	0.25	0.032	0.81	0.215	5.47
C9402A	3	24	7/32	0.010	0.25	0.032	0.81	0.226	5.74
C9403A	4	24	7/32	0.010	0.25	0.032	0.81	0.246	6.24
C9404A	5	24	7/32	0.010	0.25	0.032	0.81	0.266	6.75
C9405A	6	24	7/32	0.010	0.25	0.032	0.81	0.287	7.30
C9406A	9	24	7/32	0.010	0.25	0.032	0.81	0.331	8.42
C9407A	11	24	7/32	0.010	0.25	0.032	0.81	0.359	9.13
C9408A	15	24	7/32	0.010	0.25	0.032	0.81	0.410	10.41
C9410A	1	22	7/30	0.010	0.25	0.032	0.81	0.169	4.29
C9411A	2	22	7/30	0.010	0.25	0.032	0.81	0.235	5.98
C9412A	3	22	7/30	0.010	0.25	0.032	0.81	0.248	6.29
C9413A	4	22	7/30	0.010	0.25	0.032	0.81	0.270	6.85
C9414A	5	22	7/30	0.010	0.25	0.032	0.81	0.293	7.44
C9415A	6	22	7/30	0.010	0.25	0.032	0.81	0.318	8.06
C9416A	9	22	7/30	0.010	0.25	0.032	0.81	0.368	9.34
C9417A	11	22	7/30	0.010	0.25	0.032	0.81	0.400	10.15
C9418A	15	22	7/30	0.010	0.25	0.032	0.81	0.457	11.61
C9420A	2	20	7/28	0.016	0.41	0.032	0.81	0.299	7.60
C9421A	3	20	7/28	0.016	0.41	0.032	0.81	0.316	8.03
C9422A	6	20	7/28	0.016	0.41	0.032	0.81	0.413	10.49
C9423A	9	20	7/28	0.016	0.41	0.032	0.81	0.483	12.26
C9424A	12	20	7/28	0.016	0.41	0.032	0.81	0.544	13.82
C9426A	3	18	16/30	0.016	0.41	0.032	0.81	0.352	8.95
C9427A	6	18	16/30	0.016	0.41	0.032	0.81	0.463	11.77

EXZEL® Multi-Paired, Foil/Braid Shielded

UL 2464, NEC Type CM (UL), CSA CMG



PART NUMBER	PAIRS	AWG SIZE	COND. STRAND	NOMINAL INSULATION THICKNESS		NOMINAL JACKET THICKNESS		NOMINAL CABLE DIAMETER	
				INCHES	mm	INCHES	mm	INCHES	mm
C9500A	1	24	7/32	0.010	0.25	0.032	0.81	0.184	4.67
C9501A	2	24	7/32	0.010	0.25	0.032	0.81	0.242	6.10
C9502A	3	24	7/32	0.010	0.25	0.032	0.81	0.253	6.40
C9503A	4	24	7/32	0.010	0.25	0.032	0.81	0.273	6.88
C9504A	5	24	7/32	0.010	0.25	0.032	0.81	0.293	7.42
C9505A	6	24	7/32	0.010	0.25	0.032	0.81	0.314	7.98
C9506A	9	24	7/32	0.010	0.25	0.032	0.81	0.358	9.14
C9507A	11	24	7/32	0.010	0.25	0.032	0.81	0.386	9.78
C9508A	15	24	7/32	0.010	0.25	0.032	0.81	0.437	10.90
C9510A	1	22	7/30	0.010	0.25	0.032	0.81	0.196	4.98
C9511A	2	22	7/30	0.010	0.25	0.032	0.81	0.262	6.60
C9512A	3	22	7/30	0.010	0.25	0.032	0.81	0.275	6.93
C9513A	4	22	7/30	0.010	0.25	0.032	0.81	0.297	7.49
C9514A	5	22	7/30	0.010	0.25	0.032	0.81	0.320	8.10
C9515A	6	22	7/30	0.010	0.25	0.032	0.81	0.345	8.74
C9516A	9	22	7/30	0.010	0.25	0.032	0.81	0.395	10.06
C9517A	11	22	7/30	0.010	0.25	0.032	0.81	0.427	10.77
C9518A	15	22	7/30	0.010	0.25	0.032	0.81	0.484	12.07
C9520A	2	20	7/28	0.016	0.41	0.032	0.81	0.326	8.28
C9521A	3	20	7/28	0.016	0.41	0.032	0.81	0.343	8.74
C9522A	6	20	7/28	0.016	0.41	0.032	0.81	0.440	11.25
C9523A	9	20	7/28	0.016	0.41	0.032	0.81	0.510	13.08
C9525A	2	18	16/30	0.016	0.41	0.032	0.81	0.360	9.02
C9526A	3	18	16/30	0.016	0.41	0.032	0.81	0.379	9.55
C9527A	6	18	16/30	0.016	0.41	0.032	0.81	0.490	12.40
C9528A	9	18	16/30	0.016	0.41	0.053	1.35	0.612	15.52

Product Construction:

Conductor:

- Fully annealed stranded tinned copper per ASTM B33

Insulation:

- Premium-grade, color-coded PVC
- Color per Chart C for 24 AWG and 22 AWG on page 97
- Color per Chart D for 20 AWG and larger on page 97

Shield:

- Dual foil with overall braided shield
- Aluminum/polyester/aluminum foil with 100% coverage
- Stranded tinned copper drain wire
- Tinned copper braided shield, 70% min coverage

Jacket:

- Premium PVC
- Operating temperature range: -30°C to +105°C (Type CM) -30°C to +80°C (AWM)

Applications:

- Advanced signal transmission in controlled environments
- Medical instrumentation and equipment
- Consumer electronic peripherals
- Industrial process control systems
- Suitable for EIA RS-232 applications

Features:

- Oil-resistant per UL Oil Res I and Class 43
- Sunlight-resistant
- Nylon ripcord

Compliances:

- NEC Article 800 Type CM (UL: 105°C)
- UL Style 2464 (UL: 80°C, 300 V, VW-1)
- CSA Type CMG (CSA: 105°C, FT4)
- CE: Low-Voltage Directive (LVD) 2006/95/EC
- RoHS Compliant Directive 2011/65/EU
- Vertical Tray Cable Flame Test per UL 1581 and IEEE 383 (70,000 BTU)

Packaging

- Please contact Customer Service for packaging and color options

Data subject to change.



EXZEL® Multi-Conductor, Unshielded, Heavy Duty

UL 2343, NEC Type CM (UL), CSA CMG

Product Construction:**Conductor:**

- Fully annealed stranded tinned copper per ASTM B33

Insulation:

- Premium-grade, color-coded PVC
- Color per Chart A on page 97

Shield:

- Unshielded

Jacket:

- Premium PVC
- Operating temperature range: -30°C to +105°C (Type CM) -30°C to +80°C (AWM)

Applications:

- Advanced signal transmission in controlled environments
- Medical instrumentation and equipment
- Consumer electronic peripherals
- Industrial process control systems
- Suitable for EIA RS-232 applications

Features:

- Oil-resistant per UL Oil Res I and Class 43
- Sunlight-resistant
- Nylon ripcord

Compliances:

- NEC Article 800 Type CM (UL: 105°C)
- UL Style 2343 (UL: 80°C, VW-1)
- CSA Type CMG (CSA: 105°C, FT4)
- CE: Low-Voltage Directive (LVD) 2006/95/EC
- RoHS Compliant Directive 2011/65/EU
- Vertical Tray Cable Flame Test per UL 1581 and IEEE 383 (70,000 BTU)

Packaging

- Please contact Customer Service for packaging and color options

Data subject to change.

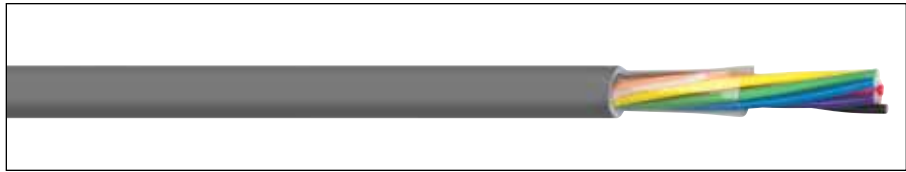

PART NUMBER	COND.	AWG SIZE	COND. STRAND	NOMINAL INSULATION THICKNESS		NOMINAL JACKET THICKNESS		NOMINAL CABLE DIAMETER	
				INCHES	mm	INCHES	mm	INCHES	mm
C9058A	7	24	7/32	0.010	0.25	0.063	1.6	0.260	6.60
C9059A	12	24	7/32	0.010	0.25	0.063	1.6	0.309	7.86
C9060A	15	24	7/32	0.010	0.25	0.063	1.6	0.333	8.46
C9061A	19	24	7/32	0.010	0.25	0.063	1.6	0.346	8.79
C9062A	2	22	7/30	0.010	0.25	0.063	1.6	0.229	5.82
C9063A	7	22	7/30	0.010	0.25	0.063	1.6	0.278	7.06
C9064A	12	22	7/30	0.010	0.25	0.063	1.6	0.334	8.49
C9065A	15	22	7/30	0.010	0.25	0.063	1.6	0.361	9.18
C9066A	19	22	7/30	0.010	0.25	0.063	1.6	0.376	9.55
C9067A	25	22	7/30	0.010	0.25	0.063	1.6	0.425	10.80
C9068A	2	20	7/28	0.010	0.25	0.063	1.6	0.243	6.17
C9069A	5	20	7/28	0.010	0.25	0.063	1.6	0.282	7.17
C9070A	7	20	7/28	0.010	0.25	0.063	1.6	0.299	7.59
C9071A	12	20	7/28	0.010	0.25	0.063	1.6	0.363	9.23
C9072A	15	20	7/28	0.010	0.25	0.063	1.6	0.394	10.01
C9073A	19	20	7/28	0.010	0.25	0.063	1.6	0.411	10.44
C9074A	25	20	7/28	0.010	0.25	0.063	1.6	0.467	11.86

EXZEL® Multi-Conductor, Foil Shielded, Heavy Duty

UL 2343, NEC Type CM (UL), CSA CMG

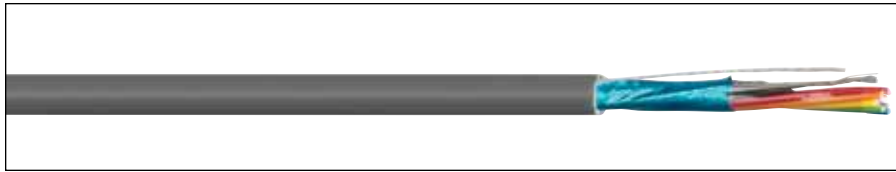

Product Construction:

Conductor:

- Fully annealed stranded tinned copper per ASTM B33

Insulation:

- Premium-grade, color-coded PVC
- Color per Chart A on page 97

Shield:

- 100% Flexfoil® aluminum/polyester, foil facing in
- Stranded tinned copper drain wire

Jacket:

- Premium PVC
- Operating temperature range: -30°C to +105°C (Type CM) -30°C to +80°C (AWM)

Applications:

- Advanced signal transmission in controlled environments
- Medical instrumentation and equipment
- Consumer electronic peripherals
- Industrial process control systems
- Suitable for EIA RS-232 applications

Features:

- Oil-resistant per UL Oil Res I and Class 43
- Sunlight-resistant
- Nylon ripcord

Compliances:

- NEC Article 800 Type CM (UL: 105°C)
- UL Style 2343 (UL: 80°C, VW-1)
- CSA Type CMG (CSA: 105°C, FT4)
- CE: Low-Voltage Directive (LVD) 2006/95/EC
- RoHS Compliant Directive 2011/65/EU
- Vertical Tray Cable Flame Test per UL 1581 and IEEE 383 (70,000 BTU)

Packaging

- Please contact Customer Service for packaging and color options

Data subject to change.

PART NUMBER	COND.	AWG SIZE	COND. STRAND	NOMINAL INSULATION THICKNESS		NOMINAL JACKET THICKNESS		NOMINAL CABLE DIAMETER	
				INCHES	mm	INCHES	mm	INCHES	mm
C9158A	3	24	7/32	0.010	0.25	0.063	1.6	0.225	5.73
C9159A	5	24	7/32	0.010	0.25	0.063	1.6	0.249	6.33
C9160A	7	24	7/32	0.010	0.25	0.063	1.6	0.262	6.65
C9161A	12	24	7/32	0.010	0.25	0.063	1.6	0.311	7.91
C9162A	15	24	7/32	0.010	0.25	0.063	1.6	0.335	8.51
C9163A	19	24	7/32	0.010	0.25	0.063	1.6	0.348	8.84
C9164A	2	22	7/30	0.010	0.25	0.063	1.6	0.231	5.87
C9165A	5	22	7/30	0.010	0.25	0.063	1.6	0.265	6.74
C9166A	7	22	7/30	0.010	0.25	0.063	1.6	0.280	7.11
C9167A	12	22	7/30	0.010	0.25	0.063	1.6	0.336	8.54
C9168A	15	22	7/30	0.010	0.25	0.063	1.6	0.363	9.23
C9169A	19	22	7/30	0.010	0.25	0.063	1.6	0.378	9.60
C9170A	2	20	7/28	0.010	0.25	0.063	1.6	0.245	6.22
C9171A	5	20	7/28	0.010	0.25	0.063	1.6	0.284	7.22
C9172A	7	20	7/28	0.010	0.25	0.063	1.6	0.301	7.65
C9173A	12	20	7/28	0.010	0.25	0.063	1.6	0.365	9.28
C9174A	15	20	7/28	0.010	0.25	0.063	1.6	0.396	10.06
C9175A	19	20	7/28	0.010	0.25	0.063	1.6	0.413	10.49



EXZEL® Multi-Conductor, Foil/Braid Shielded, Heavy Duty

UL 2343, NEC Type CM (UL), CSA CMG

Product Construction:**Conductor:**

- Fully annealed stranded tinned copper per ASTM B33

Insulation:

- Premium-grade, color-coded PVC
- Color per Chart A on page 97

Shield:

- Dual foil with overall braided shield
- Aluminum/polyester/aluminum foil with 100% coverage
- Stranded tinned copper drain wire
- Tinned copper braided shield, 70% min coverage

Jacket:

- Premium PVC
- Operating temperature range:
-30°C to +105°C (Type CM)
-30°C to +80°C (AWM)

Applications:

- Advanced signal transmission in controlled environments
- Medical instrumentation and equipment
- Consumer electronic peripherals
- Industrial process control systems
- Suitable for EIA RS-232 applications

Features:

- Oil-resistant per UL Oil Res I and Class 43
- Sunlight-resistant
- Nylon ripcord

Compliances:

- NEC Article 800 Type CM (UL: 105°C)
- UL Style 2343 (UL: 80°C, VW-1)
- CSA Type CMG (CSA: 105°C, FT4)
- CE: Low-Voltage Directive (LVD) 2006/95/EC
- RoHS Compliant Directive 2011/65/EU
- Vertical Tray Cable Flame Test per UL 1581 and IEEE 383 (70,000 BTU)

Packaging

- Please contact Customer Service for packaging and color options

Data subject to change.

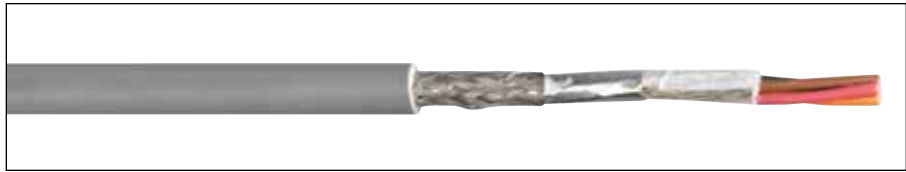

PART NUMBER	COND.	AWG SIZE	COND. STRAND	NOMINAL INSULATION THICKNESS		NOMINAL JACKET THICKNESS		NOMINAL CABLE DIAMETER	
				INCHES	mm	INCHES	mm	INCHES	mm
C9258A	5	24	7/32	0.010	0.25	0.063	1.6	0.276	7.01
C9259A	7	24	7/32	0.010	0.25	0.063	1.6	0.289	7.34
C9260A	12	24	7/32	0.010	0.25	0.063	1.6	0.338	8.60
C9261A	15	24	7/32	0.010	0.25	0.063	1.6	0.362	9.20
C9262A	19	24	7/32	0.010	0.25	0.063	1.6	0.375	9.53
C9263A	5	22	7/30	0.010	0.25	0.063	1.6	0.292	7.42
C9264A	7	22	7/30	0.010	0.25	0.063	1.6	0.307	7.80
C9265A	12	22	7/30	0.010	0.25	0.063	1.6	0.363	9.23
C9266A	15	22	7/30	0.010	0.25	0.063	1.6	0.390	9.91
C9267A	19	22	7/30	0.010	0.25	0.063	1.6	0.405	10.29
C9268A	4	20	7/28	0.010	0.25	0.063	1.6	0.296	7.51
C9269A	5	20	7/28	0.010	0.25	0.063	1.6	0.311	7.90
C9270A	7	20	7/28	0.010	0.25	0.063	1.6	0.328	8.33
C9271A	12	20	7/28	0.010	0.25	0.063	1.6	0.392	9.97
C9272A	15	20	7/28	0.010	0.25	0.063	1.6	0.423	10.75
C9273A	19	20	7/28	0.010	0.25	0.063	1.6	0.440	11.18

EXZEL® Multi-Paired, Foil/Braid Shielded, Heavy Duty

UL 2343, NEC Type CM (UL), CSA CMG

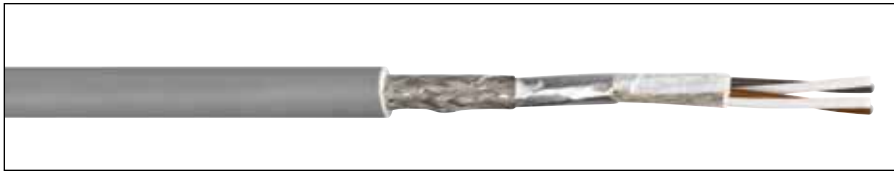

PART NUMBER	PAIRS	AWG SIZE	COND. STRAND	NOMINAL INSULATION THICKNESS		NOMINAL JACKET THICKNESS		NOMINAL CABLE DIAMETER	
				INCHES	mm	INCHES	mm	INCHES	mm
C9538A	5	24	7/32	0.010	0.25	0.063	1.6	0.355	9.01
C9539A	7	24	7/32	0.010	0.25	0.063	1.6	0.376	9.56
C9540A	12	24	7/32	0.010	0.25	0.063	1.6	0.459	11.67
C9541A	15	24	7/32	0.010	0.25	0.063	1.6	0.499	12.67
C9543A	2	22	7/30	0.010	0.25	0.063	1.6	0.324	8.24
C9544A	5	22	7/30	0.010	0.25	0.063	1.6	0.382	9.70
C9545A	7	22	7/30	0.010	0.25	0.063	1.6	0.407	10.33
C9546A	12	22	7/30	0.010	0.25	0.063	1.6	0.501	12.73
C9548A	4	20	7/28	0.010	0.25	0.063	1.6	0.387	9.84
C9549A	5	20	7/28	0.010	0.25	0.063	1.6	0.414	10.50
C9550A	7	20	7/28	0.010	0.25	0.063	1.6	0.442	11.22
C9551A	9	20	7/28	0.010	0.25	0.063	1.6	0.499	12.68
C9552A	15	20	7/28	0.010	0.25	0.063	1.6	0.601	15.28

Product Construction:

Conductor:

- Fully annealed stranded tinned copper per ASTM B33

Insulation:

- Premium-grade, color-coded PVC
- Color per Chart C on page 97

Shield:

- Dual foil with overall braided shield
- Aluminum/polyester/aluminum foil with 100% coverage
- Stranded tinned copper drain wire
- Tinned copper braided shield, 70% min coverage

Jacket:

- Premium PVC
- Operating temperature range: -30°C to +105°C

Applications:

- Advanced signal transmission in controlled environments
- Medical instrumentation and equipment
- Consumer electronic peripherals
- Industrial process control systems
- Suitable for EIA RS-232 applications

Features:

- Oil-resistant per UL Oil Res I and Class 43
- Sunlight-resistant
- Nylon ripcord

Compliances:

- NEC Article 800 Type CM (UL: 105°C)
- UL Style 2343 (UL: 80°C, VW-1)
- CSA Type CMG (CSA: 105°C, FT4)
- CE: Low-Voltage Directive (LVD) 2006/95/EC
- RoHS Compliant Directive 2011/65/EU
- Vertical Tray Cable Flame Test per UL 1581 and IEEE 383 (70,000 BTU)

Packaging

- Please contact Customer Service for packaging and color options

Data subject to change.

EXZEL® LSZH Multi-Conductor, Unshielded

NEC Type CM, CMG, CL2 or PLTC-ER (UL)

Product Construction:

Conductor:

- Fully annealed stranded tinned copper per ASTM B33

Insulation:

- Premium-grade, color-coded LSZH
- Color per Chart A for 24 AWG and 22 AWG on page 97
- Color per Chart B for 20 AWG and larger on page 97
- International colors per IEC Color Chart on page 97

Shield:

- Unshielded

Jacket:

- Premium FR-LSZH (Thermoplastic Polyolefin)
- Operating temperature range: -40°C to +105°C

Applications:

- Advanced signal transmission in controlled environments
- Medical instrumentation and equipment
- Consumer electronic peripherals
- Industrial process control systems
- Suitable for EIA RS-232 applications

Features:

- Oil-resistant (OIL RES I)
- Sunlight-resistant (SUN RES)
- Nylon ripcord
- UV-resistant

Compliances:

- NEC Article 725 Type PLTC-ER (22 AWG and larger, UL: 105°C, 300 V)
- (-ER): approved for Exposed Run as defined per NEC Article 725
- NEC Article 725 Type CL2 (UL: 105°C, 150 V)
- NEC Article 800 Type CM/CMG (UL: 105°C, 300 V)
- CE Compliant to IEC Directive 93/68/EEC
- RoHS Compliant Directive 2011/65/EU

Compliances: Flame & Smoke

- Vertical Tray Cable Flame Test per UL 1581 and IEEE 383 (70,000 BTU)
- CSA FT4/IEEE 1202 flame test per UL 1685
- IEC 60332-1, 3, Cat A: Flammability
- IEC 61034-1, 2 and Mil-DTL-24643B and NES 711: Smoke Index Emission
- IEC 60754-1, 2 and Mil-DTL-24643B: Halogen Content and Acid Gas Generation

Packaging

- Please contact Customer Service for packaging and color options

Data subject to change.

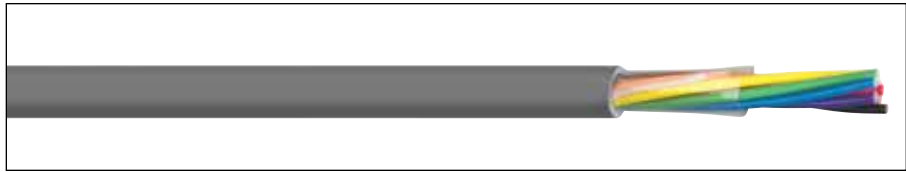

PART NUMBER	COND.	AWG SIZE	COND. STRAND	NOMINAL INSULATION THICKNESS		NOMINAL JACKET THICKNESS		NOMINAL CABLE DIAMETER	
				INCHES	mm	INCHES	mm	INCHES	mm
C9000ZH	2	24	7/32	0.010	0.25	0.032	0.81	0.160	4.06
C9001ZH	3	24	7/32	0.010	0.25	0.032	0.81	0.167	4.23
C9002ZH	4	24	7/32	0.010	0.25	0.032	0.81	0.178	4.53
C9003ZH	6	24	7/32	0.010	0.25	0.032	0.81	0.204	5.18
C9004ZH	8	24	7/32	0.010	0.25	0.032	0.81	0.218	5.53
C9005ZH	10	24	7/32	0.010	0.25	0.032	0.81	0.248	6.30
C9006ZH	15	24	7/32	0.010	0.25	0.037	0.94	0.289	7.34
C9007ZH	20	24	7/32	0.010	0.25	0.037	0.94	0.316	8.02
C9008ZH	25	24	7/32	0.010	0.25	0.037	0.94	0.346	8.79
C9009ZH	2	22	7/30	0.013	0.33	0.037	0.94	0.182	4.62
C9010ZH	3	22	7/30	0.013	0.33	0.037	0.94	0.190	4.81
C9011ZH	4	22	7/30	0.013	0.33	0.037	0.94	0.203	5.16
C9012ZH	6	22	7/30	0.013	0.33	0.037	0.94	0.232	5.89
C9013ZH	8	22	7/30	0.013	0.33	0.037	0.94	0.248	6.29
C9014ZH	10	22	7/30	0.013	0.33	0.042	1.07	0.292	7.42
C9015ZH	15	22	7/30	0.013	0.33	0.042	1.07	0.327	8.31
C9016ZH	20	22	7/30	0.013	0.33	0.042	1.07	0.358	9.08
C9017ZH	25	22	7/30	0.013	0.33	0.052	1.32	0.412	10.46
C9018ZH	2	20	7/28	0.016	0.41	0.037	0.94	0.222	5.64
C9019ZH	3	20	7/28	0.016	0.41	0.037	0.94	0.233	5.91
C9020ZH	4	20	7/28	0.016	0.41	0.037	0.94	0.251	6.39
C9021ZH	6	20	7/28	0.016	0.41	0.042	1.07	0.302	7.67
C9022ZH	8	20	7/28	0.016	0.41	0.042	1.07	0.324	8.22
C9023ZH	10	20	7/28	0.016	0.41	0.042	1.07	0.372	9.45
C9024ZH	15	20	7/28	0.016	0.41	0.052	1.32	0.441	11.20
C9025ZH	20	20	7/28	0.016	0.41	0.052	1.32	0.484	12.29
C9026ZH	25	20	7/28	0.016	0.41	0.052	1.32	0.532	13.51
C9027ZH*	2	18	16/30	0.016	0.41	0.037	0.94	0.238	6.05
C9028ZH	2	18	16/30	0.016	0.41	0.037	0.94	0.238	6.05
C9029ZH*	3	18	16/30	0.016	0.41	0.037	0.94	0.250	6.34
C9030ZH	3	18	16/30	0.016	0.41	0.037	0.94	0.250	6.34
C9031ZH	4	18	16/30	0.016	0.41	0.037	0.94	0.271	6.88
C9032ZH	6	18	16/30	0.016	0.41	0.042	1.07	0.326	8.28
C9033ZH	8	18	16/30	0.016	0.41	0.042	1.07	0.350	8.89
C9034ZH	10	18	16/30	0.016	0.41	0.052	1.32	0.424	10.77
C9035ZH	15	18	16/30	0.016	0.41	0.052	1.32	0.479	12.16
C9036ZH	20	18	16/30	0.016	0.41	0.052	1.32	0.526	13.36
C9037ZH	25	18	16/30	0.016	0.41	0.052	1.32	0.580	14.73
C9038ZH*	2	16	19/.0117	0.016	0.41	0.037	0.94	0.262	6.65
C9039ZH	2	16	19/.0117	0.016	0.41	0.037	0.94	0.262	6.65
C9040ZH*	3	16	19/.0117	0.016	0.41	0.037	0.94	0.276	7.00
C9041ZH	3	16	19/.0117	0.016	0.41	0.037	0.94	0.276	7.00
C9042ZH	4	16	19/.0117	0.016	0.41	0.042	1.07	0.310	7.87
C9043ZH	6	16	19/.0117	0.016	0.41	0.042	1.07	0.362	9.19
C9044ZH	8	16	19/.0117	0.016	0.41	0.052	1.32	0.410	10.41
C9045ZH	10	16	19/.0117	0.016	0.41	0.052	1.32	0.472	11.99
C9046ZH	15	16	19/.0117	0.016	0.41	0.052	1.32	0.535	13.59
C9047ZH	20	16	19/.0117	0.016	0.41	0.052	1.32	0.590	14.98
C9048ZH	25	16	19/.0117	0.016	0.41	0.062	1.57	0.672	17.07

* IEC Color Code: Brown, Blue, Green/Yellow.

EXZEL® LSZH Multi-Conductor, Foil Shielded

NEC Type CM, CMG, CL2 or PLTC-ER (UL)

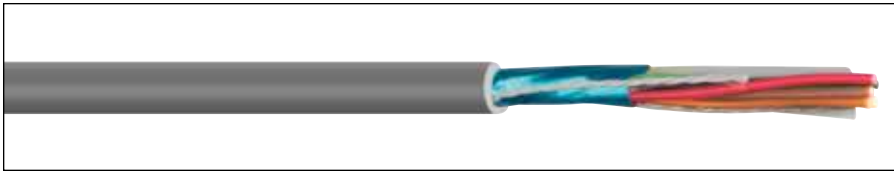

PART NUMBER	COND.	AWG SIZE	COND. STRAND	NOMINAL INSULATION THICKNESS		NOMINAL JACKET THICKNESS		NOMINAL CABLE DIAMETER	
				INCHES	mm	INCHES	mm	INCHES	mm
C9100ZH	2	24	7/32	0.010	0.25	0.032	0.81	0.165	4.19
C9101ZH	3	24	7/32	0.010	0.25	0.032	0.81	0.172	4.36
C9102ZH	4	24	7/32	0.010	0.25	0.032	0.81	0.183	4.66
C9103ZH	6	24	7/32	0.010	0.25	0.032	0.81	0.209	5.31
C9104ZH	8	24	7/32	0.010	0.25	0.032	0.81	0.223	5.66
C9105ZH	10	24	7/32	0.010	0.25	0.032	0.81	0.253	6.43
C9106ZH	15	24	7/32	0.010	0.25	0.037	0.94	0.294	7.46
C9107ZH	20	24	7/32	0.010	0.25	0.037	0.94	0.321	8.14
C9108ZH	25	24	7/32	0.010	0.25	0.037	0.94	0.351	8.92
C9109ZH	2	22	7/30	0.013	0.33	0.037	0.94	0.187	4.75
C9110ZH	3	22	7/30	0.013	0.33	0.037	0.94	0.195	4.94
C9111ZH	4	22	7/30	0.013	0.33	0.037	0.94	0.208	5.28
C9112ZH	6	22	7/30	0.013	0.33	0.037	0.94	0.237	6.02
C9113ZH	8	22	7/30	0.013	0.33	0.037	0.94	0.253	6.41
C9114ZH	10	22	7/30	0.013	0.33	0.042	1.07	0.297	7.54
C9115ZH	15	22	7/30	0.013	0.33	0.042	1.07	0.332	8.43
C9116ZH	20	22	7/30	0.013	0.33	0.042	1.07	0.363	9.21
C9117ZH	25	22	7/30	0.013	0.33	0.052	1.32	0.417	10.59
C9118ZH	2	20	7/28	0.016	0.41	0.037	0.94	0.227	5.77
C9119ZH	3	20	7/28	0.016	0.41	0.037	0.94	0.238	6.03
C9120ZH	4	20	7/28	0.016	0.41	0.037	0.94	0.256	6.51
C9121ZH	6	20	7/28	0.016	0.41	0.042	1.07	0.307	7.80
C9122ZH	8	20	7/28	0.016	0.41	0.042	1.07	0.329	8.35
C9123ZH	10	20	7/28	0.016	0.41	0.042	1.07	0.377	9.58
C9124ZH	15	20	7/28	0.016	0.41	0.052	1.32	0.446	11.33
C9125ZH	20	20	7/28	0.016	0.41	0.052	1.32	0.489	12.41
C9126ZH	25	20	7/28	0.016	0.41	0.052	1.32	0.537	13.64
C9127ZH	2	18	16/30	0.016	0.41	0.037	0.94	0.243	6.17
C9128ZH*	2	18	16/30	0.016	0.41	0.037	0.94	0.243	6.17
C9129ZH	3	18	16/30	0.016	0.41	0.037	0.94	0.255	6.47
C9130ZH*	3	18	16/30	0.016	0.41	0.037	0.94	0.255	6.47
C9131ZH	4	18	16/30	0.016	0.41	0.037	0.94	0.276	7.00
C9132ZH	6	18	16/30	0.016	0.41	0.042	1.07	0.331	8.41
C9133ZH	8	18	16/30	0.016	0.41	0.042	1.07	0.355	9.02
C9134ZH	10	18	16/30	0.016	0.41	0.052	1.32	0.429	10.90
C9135ZH	15	18	16/30	0.016	0.41	0.052	1.32	0.484	12.28
C9136ZH	20	18	16/30	0.016	0.41	0.052	1.32	0.531	13.49
C9137ZH	25	18	16/30	0.016	0.41	0.052	1.32	0.585	14.86
C9138ZH	2	16	19/.0117	0.016	0.41	0.037	0.94	0.267	6.78
C9139ZH*	2	16	19/.0117	0.016	0.41	0.037	0.94	0.267	6.78
C9140ZH	3	16	19/.0117	0.016	0.41	0.037	0.94	0.281	7.12
C9141ZH*	3	16	19/.0117	0.016	0.41	0.037	0.94	0.281	7.12
C9142ZH	4	16	19/.0117	0.016	0.41	0.042	1.07	0.315	8.00
C9143ZH	6	16	19/.0117	0.016	0.41	0.042	1.07	0.367	9.32
C9144ZH	8	16	19/.0117	0.016	0.41	0.052	1.32	0.415	10.54
C9145ZH	10	16	19/.0117	0.016	0.41	0.052	1.32	0.477	12.12
C9146ZH	15	16	19/.0117	0.016	0.41	0.052	1.32	0.540	13.72
C9147ZH	20	16	19/.0117	0.016	0.41	0.052	1.32	0.595	15.11
C9148ZH	25	16	19/.0117	0.016	0.41	0.062	1.57	0.677	17.20

* IEC Color Code: Brown, Blue, Green/Yellow.

Product Construction:

Conductor:

- Fully annealed stranded tinned copper per ASTM B33

Insulation:

- Premium-grade, color-coded LSZH (Thermoplastic Polyolefin)
- Color per Chart A for 24 AWG and 22 AWG on page 97
- Color per Chart B for 20 AWG and larger on page 97
- International colors per IEC Color Chart on page 97

Shield:

- 100% Flexfoil®, aluminum/polyester/aluminum, foil facing in
- Stranded tinned copper drain wire

Jacket:

- Premium FR-LSZH (Thermoplastic Polyolefin)
- Operating temperature range: -40°C to +105°C

Applications:

- Advanced signal transmission in controlled environments
- Medical instrumentation and equipment
- Consumer electronic peripherals
- Industrial process control systems
- Suitable for EIA RS-232 applications

Features:

- Oil-resistant (OIL RES I)
- Sunlight-resistant (SUN RES)
- Nylon ripcord
- UV-resistant

Compliances:

- NEC Article 725 Type PLTC-ER (22 AWG and larger, UL: 105°C, 300 V)
- (-ER): approved for Exposed Run as defined per NEC Article 725
- NEC Article 725 Type CL2 (UL: 105°C, 150 V)
- NEC Article 800 Type CM/CMG (UL: 105°C, 300 V)
- CE Compliant to IEC Directive 93/68/EEC
- RoHS Compliant Directive 2011/65/EU

Compliances: Flame & Smoke

- Vertical Tray Cable Flame Test per UL 1581 and IEEE 383 (70,000 BTU)
- CSA FT4/IEEE 1202 flame test per UL 1685
- IEC 60332-1, 3, Cat A: Flammability
- IEC 61034-1, 2 and Mil-DTL-24643B and NES 711: Smoke Index Emission
- IEC 60754-1, 2 and Mil-DTL-24643B: Halogen Content and Acid Gas Generation

Packaging

- Please contact Customer Service for packaging and color options

Data subject to change.



EXZEL® LSZH Multi-Conductor, Foil/Braid Shielded

NEC Type CM, CMG, CL2 or PLTC-ER (UL)

Product Construction:

Conductor:

- Full annealed stranded tinned copper per ASTM B33

Insulation:

- Premium-grade, color-coded LSZH (Thermoplastic Polyolefin)
- Color per Chart A for 24 AWG and 22 AWG on page 97
- Color per Chart B for 20 AWG and larger on page 97
- International colors per IEC Color Chart on page 97

Shield:

- Dual foil with overall braided shield
- Aluminum/polyester/aluminum foil with 100% coverage
- Stranded tinned copper drain wire
- Tinned copper braided shield, 85% min. coverage

Jacket:

- Premium FR-LSZH (Thermoplastic Polyolefin)
- Operating temperature range: -40°C to +105°C

Applications:

- Advanced signal transmission in controlled environments
- Medical instrumentation and equipment
- Consumer electronic peripherals
- Industrial process control systems
- Suitable for EIA RS-232 applications

Features:

- Oil-resistant (OIL RES I)
- Sunlight-resistant (SUN RES)
- Nylon ripcord
- UV-resistant

Compliances:

- NEC Article 725 Type PLTC-ER (22 AWG and larger, UL: 105°C, 300 V)
- (-ER): approved for Exposed Run as defined per NEC Article 725
- NEC Article 725 Type CL2 (UL: 105°C, 150 V)
- NEC Article 800 Type CM/CMG (UL: 105°C, 300 V)
- CE Compliant to IEC Directive 93/68/EEC
- RoHS Compliant Directive 2011/65/EU

Compliances: Flame & Smoke

- Vertical Tray Cable Flame Test per UL 1581 and IEEE 383 (70,000 BTU)
- CSA FT4/IEEE 1202 flame test per UL 1685
- IEC 60332-1, 3, Cat A: Flammability
- IEC 61034-1, 2 and Mil-DTL-24643B and NES 711: Smoke Index Emission
- IEC 60754-1, 2 and Mil-DTL-24643B: Halogen Content and Acid Gas Generation

Packaging

- Please contact Customer Service for packaging and color options

Data subject to change.

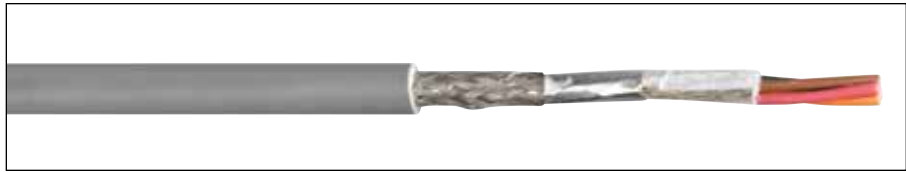

PART NUMBER	COND.	AWG SIZE	COND. STRAND	NOMINAL INSULATION THICKNESS		NOMINAL JACKET THICKNESS		NOMINAL CABLE DIAMETER	
				INCHES	mm	INCHES	mm	INCHES	mm
C9200ZH	2	24	7/32	0.010	0.25	0.032	0.81	0.187	4.75
C9201ZH	3	24	7/32	0.010	0.25	0.032	0.81	0.194	4.92
C9202ZH	4	24	7/32	0.010	0.25	0.032	0.81	0.205	5.22
C9203ZH	6	24	7/32	0.010	0.25	0.032	0.81	0.231	5.87
C9204ZH	8	24	7/32	0.010	0.25	0.032	0.81	0.245	6.21
C9205ZH	10	24	7/32	0.010	0.25	0.037	0.94	0.285	7.24
C9206ZH	15	24	7/32	0.010	0.25	0.037	0.94	0.316	8.02
C9207ZH	20	24	7/32	0.010	0.25	0.037	0.94	0.343	8.70
C9208ZH	25	24	7/32	0.010	0.25	0.037	0.94	0.373	9.47
C9209ZH	2	22	7/30	0.013	0.33	0.037	0.94	0.209	5.31
C9210ZH	3	22	7/30	0.013	0.33	0.037	0.94	0.217	5.50
C9211ZH	4	22	7/30	0.013	0.33	0.037	0.94	0.230	5.84
C9212ZH	6	22	7/30	0.013	0.33	0.037	0.94	0.259	6.58
C9213ZH	8	22	7/30	0.013	0.33	0.037	0.94	0.275	6.97
C9214ZH	10	22	7/30	0.013	0.33	0.042	1.07	0.319	8.10
C9215ZH	15	22	7/30	0.013	0.33	0.042	1.07	0.354	8.99
C9216ZH	20	22	7/30	0.013	0.33	0.042	1.07	0.385	9.77
C9217ZH	25	22	7/30	0.013	0.33	0.052	1.32	0.444	11.28
C9218ZH	2	20	7/28	0.016	0.41	0.037	0.94	0.249	6.32
C9219ZH	3	20	7/28	0.016	0.41	0.037	0.94	0.260	6.59
C9220ZH	4	20	7/28	0.016	0.41	0.037	0.94	0.278	7.07
C9221ZH	6	20	7/28	0.016	0.41	0.042	1.07	0.329	8.36
C9222ZH	8	20	7/28	0.016	0.41	0.042	1.07	0.351	8.91
C9223ZH	10	20	7/28	0.016	0.41	0.052	1.32	0.419	10.64
C9224ZH	15	20	7/28	0.016	0.41	0.052	1.32	0.473	12.01
C9225ZH	20	20	7/28	0.016	0.41	0.052	1.32	0.516	13.10
C9226ZH	25	20	7/28	0.016	0.41	0.052	1.32	0.564	14.33
C9227ZH*	2	18	16/30	0.016	0.41	0.037	0.94	0.265	6.73
C9228ZH	2	18	16/30	0.016	0.41	0.037	0.94	0.265	6.73
C9229ZH*	3	18	16/30	0.016	0.41	0.037	0.94	0.277	7.03
C9230ZH	3	18	16/30	0.016	0.41	0.037	0.94	0.277	7.03
C9231ZH	4	18	16/30	0.016	0.41	0.042	1.07	0.308	7.82
C9232ZH	6	18	16/30	0.016	0.41	0.042	1.07	0.353	8.97
C9233ZH	8	18	16/30	0.016	0.41	0.042	1.07	0.377	9.58
C9234ZH	10	18	16/30	0.016	0.41	0.052	1.32	0.456	11.58
C9235ZH	15	18	16/30	0.016	0.41	0.052	1.32	0.511	12.97
C9236ZH	20	18	16/30	0.016	0.41	0.052	1.32	0.558	14.18
C9237ZH	25	18	16/30	0.016	0.41	0.062	1.57	0.632	16.05
C9238ZH*	2	16	19/.0117	0.016	0.41	0.042	1.07	0.299	7.59
C9239ZH	2	16	19/.0117	0.016	0.41	0.042	1.07	0.299	7.59
C9240ZH*	3	16	19/.0117	0.016	0.41	0.042	1.07	0.313	7.94
C9241ZH	3	16	19/.0117	0.016	0.41	0.042	1.07	0.313	7.94
C9242ZH	4	16	19/.0117	0.016	0.41	0.042	1.07	0.337	8.55
C9243ZH	6	16	19/.0117	0.016	0.41	0.052	1.32	0.409	10.39
C9244ZH	8	16	19/.0117	0.016	0.41	0.052	1.32	0.437	11.10
C9245ZH	10	16	19/.0117	0.016	0.41	0.052	1.32	0.504	12.80
C9246ZH	15	16	19/.0117	0.016	0.41	0.052	1.32	0.567	14.40
C9247ZH	20	16	19/.0117	0.016	0.41	0.062	1.57	0.642	16.30
C9248ZH	25	16	19/.0117	0.016	0.41	0.062	1.57	0.704	17.88

* IEC Color Code: Brown, Blue, Green/Yellow

EXZEL® LSZH Multi-Paired, Unshielded

NEC Type CM, CMG, CL2 or PLTC-ER (UL)

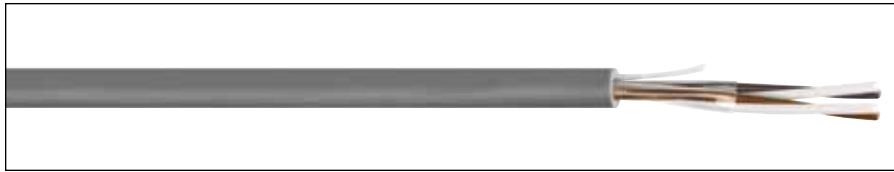

PART NUMBER	PAIRS	AWG SIZE	COND. STRAND	NOMINAL INSULATION THICKNESS		NOMINAL JACKET THICKNESS		NOMINAL CABLE DIAMETER	
				INCHES	mm	INCHES	mm	INCHES	mm
C9300ZH	1	24	7/32	0.010	0.25	0.032	0.81	0.160	4.06
C9301ZH	2	24	7/32	0.010	0.25	0.032	0.81	0.220	5.58
C9302ZH	3	24	7/32	0.010	0.25	0.032	0.81	0.231	5.87
C9303ZH	4	24	7/32	0.010	0.25	0.032	0.81	0.251	6.37
C9304ZH	5	24	7/32	0.010	0.25	0.037	0.94	0.282	7.15
C9305ZH	6	24	7/32	0.010	0.25	0.037	0.94	0.304	7.72
C9306ZH	9	24	7/32	0.010	0.25	0.037	0.94	0.350	8.88
C9307ZH	11	24	7/32	0.010	0.25	0.037	0.94	0.378	9.59
C9308ZH	15	24	7/32	0.010	0.25	0.047	1.19	0.449	11.42
C9309ZH	1	22	7/30	0.013	0.33	0.037	0.94	0.182	4.62
C9310ZH	2	22	7/30	0.013	0.33	0.037	0.94	0.250	6.35
C9311ZH	3	22	7/30	0.013	0.33	0.037	0.94	0.263	6.67
C9312ZH	4	22	7/30	0.013	0.33	0.042	1.07	0.295	7.50
C9313ZH	5	22	7/30	0.013	0.33	0.042	1.07	0.319	8.10
C9314ZH	6	22	7/30	0.013	0.33	0.042	1.07	0.344	8.74
C9326ZH	9	22	7/30	0.013	0.33	0.052	1.32	0.416	10.57
C9327ZH	12	22	7/30	0.013	0.33	0.052	1.32	0.461	11.70
C9315ZH	15	22	7/30	0.013	0.33	0.052	1.32	0.507	12.87
C9328ZH	1	20	7/28	0.016	0.41	0.037	0.94	0.222	5.64
C9316ZH	2	20	7/28	0.016	0.41	0.042	1.07	0.327	8.31
C9317ZH	3	20	7/28	0.016	0.41	0.042	1.07	0.345	8.76
C9329ZH	4	20	7/28	0.016	0.41	0.042	1.07	0.377	9.57
C9330ZH	5	20	7/28	0.016	0.41	0.052	1.32	0.430	10.91
C9318ZH	6	20	7/28	0.016	0.41	0.052	1.32	0.465	11.81
C9319ZH	9	20	7/28	0.016	0.41	0.052	1.32	0.538	13.66
C9320ZH	12	20	7/28	0.016	0.41	0.052	1.32	0.600	15.24
C9331ZH	15	20	7/28	0.016	0.41	0.062	1.57	0.685	17.39
C9332ZH	1	18	16/30	0.016	0.41	0.037	0.94	0.238	6.05
C9321ZH	2	18	16/30	0.016	0.41	0.042	1.07	0.354	8.99
C9322ZH	3	18	16/30	0.016	0.41	0.042	1.07	0.374	9.49
C9333ZH	4	18	16/30	0.016	0.41	0.052	1.32	0.429	10.90
C9334ZH	5	18	16/30	0.016	0.41	0.052	1.32	0.466	11.83
C9323ZH	6	18	16/30	0.016	0.41	0.052	1.32	0.505	12.83
C9324ZH	9	18	16/30	0.016	0.41	0.052	1.32	0.586	14.89
C9325ZH	12	18	16/30	0.016	0.41	0.062	1.57	0.656	16.67
C9335ZH	15	18	16/30	0.016	0.41	0.062	1.57	0.748	19.00

Product Construction:

Conductor:

- Fully annealed stranded tinned copper per ASTM B33

Insulation:

- Premium-grade, color-coded LSZH (Thermoplastic Polyolefin)
- Color per Chart C for 24 AWG and 22 AWG on page 97
- Color per Chart D for 20 AWG and larger on page 97

Shield:

- Unshielded

Jacket:

- Premium FR-LSZH (Thermoplastic Polyolefin)
- Operating temperature range: -40°C to +105°C

Applications:

- Advanced signal transmission in controlled environments
- Medical instrumentation and equipment
- Consumer electronic peripherals
- Industrial process control systems
- Suitable for EIA RS-232 applications

Features:

- Oil-resistant (OIL RES I)
- Sunlight-resistant (SUN RES)
- Nylon ripcord
- UV-resistant

Compliances:

- NEC Article 725 Type PLTC-ER (22 AWG and larger, UL: 105°C, 300 V)
- (-ER): approved for Exposed Run as defined per NEC Article 725
- NEC Article 725 Type CL2 (UL: 105°C, 150 V)
- NEC Article 800 Type CM/CMG (UL: 105°C, 300 V)
- CE Compliant to IEC Directive 93/68/EEC
- RoHS Compliant Directive 2011/65/EU

Compliances: Flame & Smoke

- Vertical Tray Cable Flame Test per UL 1581 and IEEE 383 (70,000 BTU)
- CSA FT4/IEEE 1202 flame test per UL 1685
- IEC 60332-1, 3, Cat A: Flammability
- IEC 61034-1, 2 and Mil-DTL-24643B and NES 711: Smoke Index Emission
- IEC 60754-1, 2 and Mil-DTL-24643B: Halogen Content and Acid Gas Generation

Packaging

- Please contact Customer Service for packaging and color options

Data subject to change.



EXZEL® LSZH Multi-Paired, Foil Shielded

NEC Type CM, CMG, CL2 or PLTC-ER (UL)

Product Construction:

Conductor:

- Fully annealed stranded tinned copper per ASTM B33

Insulation:

- Premium-grade, color-coded LSZH (Thermoplastic Polyolefin)
- Color per Chart C for 24 AWG and 22 AWG on page 97
- Color per Chart D for 20 AWG and larger on page 97

Shield:

- 100% Flexfoil®, aluminum/polyester/aluminum, foil facing in
- Stranded tinned copper drain wire

Jacket:

- Premium FR-LSZH (Thermoplastic Polyolefin)
- Operating temperature range: -40°C to +105°C

Applications:

- Advanced signal transmission in controlled environments
- Medical instrumentation and equipment
- Consumer electronic peripherals
- Industrial process control systems
- Suitable for EIA RS-232 applications

Features:

- Oil-resistant (OIL RES I)
- Sunlight-resistant (SUN RES)
- Nylon ripcord
- UV-resistant

Compliances:

- NEC Article 725 Type PLTC-ER (22 AWG and larger, UL: 105°C, 300 V)
- (-ER): approved for Exposed Run as defined per NEC Article 725
- NEC Article 725 Type CL2 (UL: 105°C, 150 V)
- NEC Article 800 Type CM/CMG (UL: 105°C, 300 V)
- CE Compliant to IEC Directive 93/68/EEC
- RoHS Compliant Directive 2011/65/EU

Compliances: Flame & Smoke

- Vertical Tray Cable Flame Test per UL 1581 and IEEE 383 (70,000 BTU)
- CSA FT4/IEEE 1202 flame test per UL 1685
- IEC 60332-1, 3, Cat A: Flammability
- IEC 61034-1, 2 and Mil-DTL-24643B and NES 711: Smoke Index Emission
- IEC 60754-1, 2 and Mil-DTL-24643B: Halogen Content and Acid Gas Generation

Packaging

- Please contact Customer Service for packaging and color options

Data subject to change.

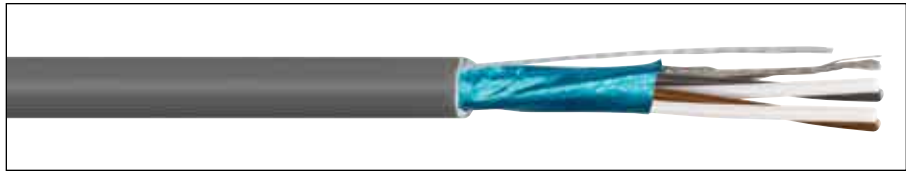

PART NUMBER	PAIRS	AWG SIZE	COND. STRAND	NOMINAL INSULATION THICKNESS		NOMINAL JACKET THICKNESS		NOMINAL CABLE DIAMETER	
				INCHES	mm	INCHES	mm	INCHES	mm
C9400ZH	1	24	7/32	0.010	0.25	0.032	0.81	0.165	4.19
C9401ZH	2	24	7/32	0.010	0.25	0.032	0.81	0.225	5.71
C9402ZH	3	24	7/32	0.010	0.25	0.032	0.81	0.236	5.99
C9403ZH	4	24	7/32	0.010	0.25	0.032	0.81	0.256	6.50
C9404ZH	5	24	7/32	0.010	0.25	0.037	0.94	0.287	7.28
C9405ZH	6	24	7/32	0.010	0.25	0.037	0.94	0.309	7.84
C9406ZH	9	24	7/32	0.010	0.25	0.037	0.94	0.355	9.01
C9407ZH	11	24	7/32	0.010	0.25	0.047	1.19	0.403	10.23
C9408ZH	15	24	7/32	0.010	0.25	0.047	1.19	0.454	11.54
C9410ZH	1	22	7/30	0.013	0.33	0.037	0.94	0.187	4.75
C9411ZH	2	22	7/30	0.013	0.33	0.037	0.94	0.255	6.48
C9412ZH	3	22	7/30	0.013	0.33	0.037	0.94	0.268	6.80
C9413ZH	4	22	7/30	0.013	0.33	0.042	1.07	0.300	7.63
C9414ZH	5	22	7/30	0.013	0.33	0.042	1.07	0.324	8.22
C9415ZH	6	22	7/30	0.013	0.33	0.042	1.07	0.349	8.86
C9416ZH	9	22	7/30	0.013	0.33	0.052	1.32	0.421	10.70
C9417ZH	11	22	7/30	0.013	0.33	0.052	1.32	0.453	11.51
C9418ZH	15	22	7/30	0.013	0.33	0.052	1.32	0.512	13.00
C9450ZH	1	20	7/28	0.016	0.41	0.037	0.94	0.227	5.77
C9420ZH	2	20	7/28	0.016	0.41	0.042	1.07	0.332	8.44
C9421ZH	3	20	7/28	0.016	0.41	0.042	1.07	0.350	8.89
C9451ZH	4	20	7/28	0.016	0.41	0.042	1.07	0.382	9.69
C9452ZH	5	20	7/28	0.016	0.41	0.052	1.32	0.435	11.04
C9422ZH	6	20	7/28	0.016	0.41	0.052	1.32	0.470	11.93
C9423ZH	9	20	7/28	0.016	0.41	0.052	1.32	0.543	13.78
C9424ZH	12	20	7/28	0.016	0.41	0.052	1.32	0.587	14.92
C9453ZH	15	20	7/28	0.016	0.41	0.062	1.57	0.690	17.52
C9454ZH	1	18	16/30	0.016	0.41	0.037	0.94	0.243	6.17
C9455ZH	2	18	16/30	0.016	0.41	0.042	1.07	0.359	9.12
C9426ZH	3	18	16/30	0.016	0.41	0.042	1.07	0.379	9.62
C9456ZH	4	18	16/30	0.016	0.41	0.052	1.32	0.434	11.03
C9457ZH	5	18	16/30	0.016	0.41	0.052	1.32	0.471	11.96
C9427ZH	6	18	16/30	0.016	0.41	0.052	1.32	0.510	12.96
C9458ZH	9	18	16/30	0.016	0.41	0.052	1.32	0.591	15.02
C9459ZH	12	18	16/30	0.016	0.41	0.062	1.57	0.681	17.29
C9460ZH	15	18	16/30	0.016	0.41	0.062	1.57	0.753	19.12

EXZEL® LSZH Multi-Paired, Foil/Braid Shielded

NEC Type CM, CMG, CL2 or PLTC-ER (UL)



PART NUMBER	PAIRS	AWG SIZE	COND. STRAND	NOMINAL INSULATION THICKNESS		NOMINAL JACKET THICKNESS		NOMINAL CABLE DIAMETER	
				INCHES	mm	INCHES	mm	INCHES	mm
C9500ZH	1	24	7/32	0.010	0.25	0.032	0.81	0.187	4.75
C9501ZH	2	24	7/32	0.010	0.25	0.032	0.81	0.247	6.27
C9502ZH	3	24	7/32	0.010	0.25	0.032	0.81	0.258	6.55
C9503ZH	4	24	7/32	0.010	0.25	0.037	0.94	0.288	7.31
C9504ZH	5	24	7/32	0.010	0.25	0.037	0.94	0.309	7.84
C9505ZH	6	24	7/32	0.010	0.25	0.037	0.94	0.331	8.40
C9506ZH	9	24	7/32	0.010	0.25	0.037	0.94	0.377	9.57
C9507ZH	11	24	7/32	0.010	0.25	0.047	1.19	0.425	10.79
C9508ZH	15	24	7/32	0.010	0.25	0.047	1.19	0.476	12.10
C9510ZH	1	22	7/30	0.013	0.33	0.037	0.94	0.209	5.31
C9511ZH	2	22	7/30	0.013	0.33	0.037	0.94	0.277	7.04
C9512ZH	3	22	7/30	0.013	0.33	0.042	1.07	0.300	7.61
C9513ZH	4	22	7/30	0.013	0.33	0.042	1.07	0.322	8.19
C9514ZH	5	22	7/30	0.013	0.33	0.042	1.07	0.346	8.78
C9515ZH	6	22	7/30	0.013	0.33	0.042	1.07	0.371	9.42
C9516ZH	9	22	7/30	0.013	0.33	0.052	1.32	0.443	11.25
C9517ZH	11	22	7/30	0.013	0.33	0.052	1.32	0.480	12.19
C9518ZH	15	22	7/30	0.013	0.33	0.052	1.32	0.539	13.69
C9529ZH	1	20	7/28	0.016	0.41	0.037	0.94	0.249	6.32
C9530ZH	2	20	7/28	0.016	0.41	0.042	1.07	0.354	9.00
C9521ZH	3	20	7/28	0.016	0.41	0.042	1.07	0.372	9.44
C9531ZH	4	20	7/28	0.016	0.41	0.052	1.32	0.424	10.76
C9532ZH	5	20	7/28	0.016	0.41	0.052	1.32	0.457	11.60
C9522ZH	6	20	7/28	0.016	0.41	0.052	1.32	0.497	12.62
C9523ZH	9	20	7/28	0.016	0.41	0.052	1.32	0.570	14.47
C9533ZH	12	20	7/28	0.016	0.41	0.062	1.57	0.652	16.56
C9534ZH	15	20	7/28	0.016	0.41	0.062	1.57	0.717	18.20
C9535ZH	1	18	16/30	0.016	0.41	0.037	0.94	0.265	6.73
C9525ZH	2	18	16/30	0.016	0.41	0.042	1.07	0.381	9.68
C9526ZH	3	18	16/30	0.016	0.41	0.052	1.32	0.421	10.69
C9536ZH	4	18	16/30	0.016	0.41	0.052	1.32	0.461	11.71
C9537ZH	5	18	16/30	0.016	0.41	0.052	1.32	0.498	12.64
C9527ZH	6	18	16/30	0.016	0.41	0.052	1.32	0.537	13.64
C9528ZH	9	18	16/30	0.016	0.41	0.062	1.57	0.638	16.21
C9538ZH	12	18	16/30	0.016	0.41	0.062	1.57	0.708	17.98
C9539ZH	15	18	16/30	0.016	0.41	0.062	1.57	0.780	19.81

Product Construction:

Conductor:

- Fully annealed stranded tinned copper per ASTM B33

Insulation:

- Premium-grade, color-coded LSZH (Thermoplastic Polyolefin)
- Color per Chart C for 24 AWG and 22 AWG on page 97
- Color per Chart D for 20 AWG and larger on page 97

Shield:

- Dual foil with overall braided shield
- Aluminum/polyester/aluminum foil with 100% coverage
- Stranded tinned copper drain wire
- Tinned copper braided shield, 85% min. coverage

Jacket:

- Premium FR-LSZH (Thermoplastic Polyolefin)
- Operating temperature range: -40°C to +105°C

Applications:

- Advanced signal transmission in controlled environments
- Medical instrumentation and equipment
- Consumer electronic peripherals
- Industrial process control systems
- Suitable for EIA RS-232 applications

Features:

- Oil-resistant (OIL RES I)
- Sunlight-resistant (SUN RES)
- Nylon ripcord
- UV-resistant

Compliances:

- NEC Article 725 Type PLTC-ER (22 AWG and larger, UL: 105°C, 300 V)
- (-ER): approved for Exposed Run as defined per NEC Article 725
- NEC Article 725 Type CL2 (UL: 105°C, 150 V)
- NEC Article 800 Type CM/CMG (UL: 105°C, 300 V)
- CE Compliant to IEC Directive 93/68/EEC
- RoHS Compliant Directive 2011/65/EU

Compliances: Flame & Smoke

- Vertical Tray Cable Flame Test per UL 1581 and IEEE 383 (70,000 BTU)
- CSA FT4/IEEE 1202 flame test per UL 1685
- IEC 60332-1, 3, Cat A: Flammability
- IEC 61034-1, 2 and Mil-DTL-24643B and NES 711: Smoke Index Emission
- IEC 60754-1, 2 and Mil-DTL-24643B: Halogen Content and Acid Gas Generation

Packaging

- Please contact Customer Service for packaging and color options

Data subject to change.



Color Code Charts

Multi-Conductor Cables

NO. OF CONDUCTORS	Color Chart A 24 AWG & 22 AWG	Color Chart B 20 AWG and Larger
	COLOR	COLOR
1	Black	Black
2	Brown	Red
3	Red	White
4	Orange	Green
5	Yellow	Orange
6	Green	Blue
7	Blue	Brown
8	Purple	Yellow
9	Slate	Purple
10	White	Slate
11	White/Black	Pink
12	White/Brown	Tan
13	White/Red	Red/Green
14	White/Orange	Red/Yellow
15	White/Yellow	Red/Black
16	White/Green	White/Black
17	White/Blue	White/Red
18	White/Purple	White/Green
19	White/Slate	White/Yellow
20	White/Black/Brown	White/Blue
21	White/Black/Red	White/Brown
22	White/Black/Orange	White/Orange
23	White/Black/Yellow	White/Slate
24	White/Black/Green	White/Purple
25	White/Black/Blue	White/Black/Red

Multi-Pair Cables

NO. OF PAIRS	Color Chart C 24 AWG & 22 AWG	Color Chart D 20 AWG and Larger
	COLOR	COLOR
1	White-Black	Black-Red
2	White-Brown	Black-White
3	White-Red	Black-Green
4	White-Orange	Black-Blue
5	White-Yellow	Black-Brown
6	White-Green	Black-Yellow
7	White-Blue	Black-Orange
8	White-Purple	Red-Green
9	White-Slate	Red-White
10	Black-Brown	Red-Blue
11	Black-Red	Red-Yellow
12	Black-Orange	Red-Brown
13	Black-Yellow	Red-Orange
14	Black-Green	Green-Blue
15	Black-Blue	Green-White

IEC Color Chart

NO. OF CONDUCTORS	COLOR
1	Brown
2	Blue
3	Green/Yellow

Fire Alarm Cables 5

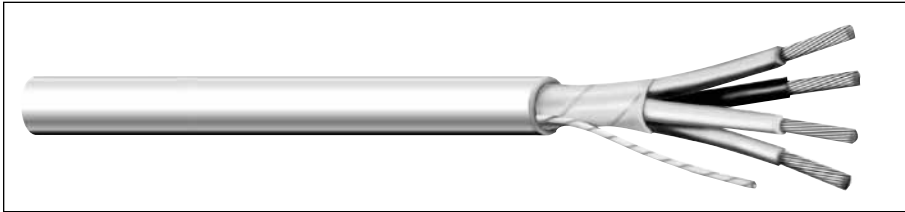

Fire alarm systems have expanded from a rather simple and unsophisticated business configured upon large, electro-mechanical devices to one relying upon the most modern technologies of microprocessor and chip technology.

More and more end users— industrial, commercial as well as consumer—are relying upon these emerging systems to protect both property and life. These systems are only as good as their weakest component, whether that component be a processor or interconnecting wire and cable.

It is General Cable’s charter that all products supplied for use in these and any other systems shall be constructed of only the finest available materials, and provide the service and assurance that the end user not only needs, but requires.

Aside from the quality materials used in these designs, specifiers and end users of Carol® Brand wire and cable products have come to expect that these cables are registered and certified with the leading regulatory agencies such as Underwriters Laboratories ... and we haven’t let you down!

These designs have proven themselves in the area of fire system security over time; all are fabricated with solid, bare copper conductors and insulations and jackets of premium-grade PVC. Offered both with and without shields, the former to protect these critical circuits from noise, these cables will provide the latest in available technology for the system installer and contractor.

General Cable Carol Brand products are conveniently packaged in 1000' or 500' lengths to assist the installer.

Index	Page
Multi-Conductor, Unshielded, Non-Plenum	99
Multi-Conductor, Unshielded, Non-Plenum (CSA)	100
Multi-Conductor, Shielded, Non-Plenum	101
Multi-Conductor, Shielded, Non-Plenum (CSA)	102
Multi-Conductor, Unshielded, Plenum	103-104
Multi-Conductor, Shielded, Plenum	105-106
Mid-Capacitance, Unshielded, Non-Plenum	107
Mid-Capacitance, Shielded, Non-Plenum	108
Mid-Capacitance, Unshielded, Plenum	109
Mid-Capacitance, Shielded, Plenum	110
Multi-Paired, Unshielded, Non-Plenum (CSA)	111

Multi-Conductor, Unshielded, Non-Plenum

NEC Type FPLR and CL3R, NEC/CEC Type CMR

Product Construction:

Conductor:

- 22 thru 12 AWG fully annealed solid bare copper per ASTM B3

Insulation:

- Premium-grade, color-coded S-R PVC
- Color code: See chart below

Jacket:

- Premium-grade PVC, red
- Suitable for use from -20°C to +75°C
- Round constructions have sequential footage markings to facilitate installation
- Includes ripcord on round constructions

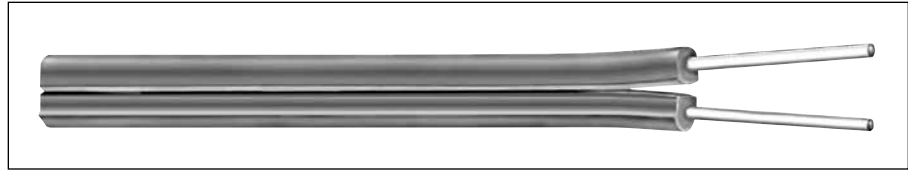

CATALOG NUMBER	NO. OF COND.	AWG SIZE	COND. STRAND	NOM. INSULATION THICKNESS		NOMINAL O.D.	
				INCHES	mm	INCHES	mm
E2402S	2	18	Solid	0.032	0.81	0.105 x 0.210	2.67 x 5.33
E2404S	2	16	Solid	0.032	0.81	0.115 x 0.230	2.92 x 5.84
E2406S	2	14	Solid	0.032	0.81	0.126 x 0.260	3.20 x 6.60

Applications:

- Wiring of fire alarms
- Smoke detectors
- Voice communications
- Burglar alarms
- Fire protective circuits
- Suggested voltage rating: 300 volts

Compliances:

- NEC Article 760 Type FPLR (UL: 75°C, 300 V)
- NEC Article 725 Type CL3R (UL: 75°C, 300 V)
- NEC Article 800 Type CMR (UL: 75°C, 300 V)
- Suitable for use in the State of California
- RoHS Compliant Directive 2011/65/EU
- Designed to meet UL 1666 Flame Test

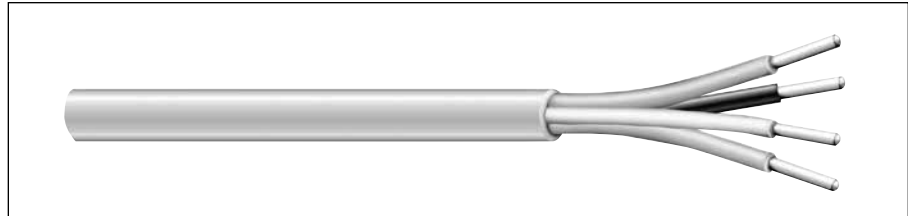

CATALOG NUMBER	NO. OF COND.	AWG SIZE	COND. STRAND	NOM. INSULATION THICKNESS		NOM. JACKET WALL		NOMINAL O.D.	
				INCHES	mm	INCHES	mm	INCHES	mm
E1482S	2	22	Solid	0.010	0.25	0.015	0.38	0.121	3.07
E1484S	4	22	Solid	0.010	0.25	0.015	0.38	0.140	3.56
E1486S	6	22	Solid	0.010	0.25	0.015	0.38	0.168	4.27
E1502S	2	18	Solid	0.010	0.25	0.015	0.38	0.150	3.81
E1503S	3	18	Solid	0.010	0.25	0.015	0.38	0.160	4.06
E1504S	4	18	Solid	0.010	0.25	0.015	0.38	0.175	4.45
E1505S	5	18	Solid	0.010	0.25	0.015	0.38	0.193	4.90
E1506S	6	18	Solid	0.010	0.25	0.015	0.38	0.210	5.33
E1508S	8	18	Solid	0.010	0.25	0.015	0.38	0.230	5.84
E1512S	2	16	Solid	0.010	0.25	0.015	0.38	0.172	4.37
E1514S	4	16	Solid	0.010	0.25	0.015	0.38	0.202	5.13
E1522S*	2	14	Solid	0.013	0.33	0.015	0.38	0.210	5.33
E1524S*	4	14	Solid	0.013	0.33	0.015	0.38	0.248	6.30
E1532S*	2	12	Solid	0.013	0.33	0.015	0.38	0.244	6.20
E1534S*	4	12	Solid	0.013	0.33	0.015	0.38	0.288	7.32

* NEC FPLR/CL3R only. Data subject to change.

Packaging:

- Please contact Customer Service for packaging and color options

Color Code Chart

NO. OF COND.	COLOR
1	Black
2	Red
3	Brown
4	Blue
5	Orange
6	Yellow
7	Purple
8	Gray

Multi-Conductor, Unshielded, Non-Plenum

CSA FAS105, FPL (UL), NEC Type PLTC

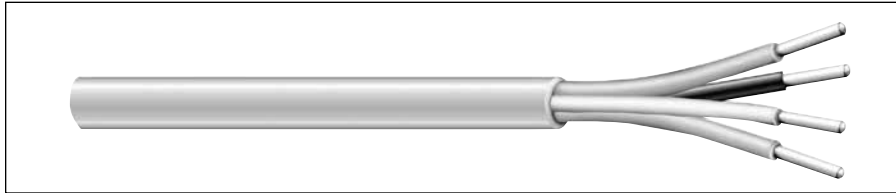

CATALOG NUMBER	NO. OF COND.	AWG SIZE	COND. STRAND	NOM. INSULATION THICKNESS		NOM. JACKET WALL		NOMINAL O.D.	
				INCHES	mm	INCHES	mm	INCHES	mm
C4300A	6	22	Solid	0.012	0.30	0.042	1.07	0.232	5.89
C4301A	15	22	Solid	0.012	0.30	0.042	1.07	0.316	8.03
C4302A	20	22	Solid	0.012	0.30	0.042	1.07	0.346	8.79
C4304A	2	18	Solid	0.015	0.38	0.042	1.07	0.225	5.71
C4305A	3	18	Solid	0.015	0.38	0.042	1.07	0.236	5.99
C4306A	4	18	Solid	0.015	0.38	0.042	1.07	0.255	6.47
C4307A	5	18	Solid	0.015	0.38	0.042	1.07	0.274	6.96
C4308A	6	18	Solid	0.015	0.38	0.042	1.07	0.296	7.52
C4309A	7	18	Solid	0.015	0.38	0.042	1.07	0.296	7.52
C4310A	8	18	Solid	0.015	0.38	0.042	1.07	0.317	8.05
C4312A	9	18	Solid	0.015	0.38	0.042	1.07	0.339	8.61
C4313A	10	18	Solid	0.015	0.38	0.042	1.07	0.366	9.30
C4314A	11	18	Solid	0.015	0.38	0.042	1.07	0.366	9.30
C4315A	15	18	Solid	0.015	0.38	0.053	1.35	0.437	11.10
C4316A	20	18	Solid	0.015	0.38	0.053	1.35	0.480	12.19
C4317A	21	18	Solid	0.015	0.38	0.053	1.35	0.480	12.19
C4318A	30	18	Solid	0.015	0.38	0.053	1.35	0.558	14.17
C4321A	2	16	Solid	0.015	0.38	0.042	1.07	0.246	6.25
C4322A	3	16	Solid	0.015	0.38	0.042	1.07	0.258	6.55
C4323A	4	16	Solid	0.015	0.38	0.042	1.07	0.280	7.11
C4349A	5	16	Solid	0.015	0.38	0.042	1.07	0.302	7.67
C4324A	2	14	Solid	0.015	0.38	0.042	1.07	0.272	6.91
C4325A	3	14	Solid	0.015	0.38	0.042	1.07	0.286	7.26
C4326A	4	14	Solid	0.015	0.38	0.042	1.07	0.311	7.90
C4327A	2	12	Solid	0.020	0.51	0.042	1.07	0.326	8.28

Data subject to change.

Product Construction:

Conductor:

- 22 thru 12 AWG fully annealed solid bare copper per ASTM B3

Insulation:

- Premium-grade PVC
- Color code: See page 229 for the CSA Fire Alarm Color Code Chart

Jacket:

- Premium-grade PVC, red
- Temperature range: -20°C to +105°C
- TRU-Mark® print legend contains footage markings from 1000' to 0'

Applications:

- Wiring of fire alarms
- Smoke alarms
- Voice communications
- Burglar alarms
- Fire protective circuits
- Suggested voltage rating: 300 volts

Compliances:

- NEC Article 725 PLTC (UL: 105°C, 300 V)
- NEC Article 760 Type FPL (UL: 105°C, 300 V)
- CSA FAS105 (CSA: 105°C, 300 V)
- C22.2 No. 208-03 (R2008) Weather (Sunlight) Resistant (1,000 HR)
- RoHS Compliant Directive 2011/65/EU
- Designed to meet UL 70,000 BTU Vertical Tray Flame Test
- Passes CSA FT4 Vertical Flame Test
- CE: Low Voltage Directive (LVD) 2006/95/EC

Packaging:

- Please contact Customer Service for packaging and color options



Multi-Conductor, Shielded, Non-Plenum

NEC Type FPLR and CL3R, NEC/CEC Type CMR

Product Construction:

Conductor:

- 22 thru 12 AWG fully annealed solid bare copper per ASTM B3

Insulation:

- Premium-grade, color-coded S-R PVC
- Color code: See chart below

Shield:

- Overall Flexfoil® polyester supported aluminum foil
- Stranded tinned copper drain wire

Jacket:

- Premium-grade PVC, red
- Temperature range: -20°C to +75°C
- Sequential footage markings to facilitate installation
- Includes ripcord

Applications:

- Wiring of fire alarms
- Smoke alarms
- Voice communications
- Burglar alarms
- Fire protective circuits
- Suggested voltage rating: 300 volts

Compliances:

- NEC Article 760 Type FPLR (UL: 75°C, 300 V)
- NEC Article 725 Type CL3R (UL: 75°C, 300 V)
- NEC Article 800 Type CMR (UL: 75°C, 300 V)
- Suitable for use in the State of California
- RoHS Compliant Directive 2011/65/EU
- Designed to meet UL 1666 Flame Test

Packaging:

- Please contact Customer Service for packaging and color options

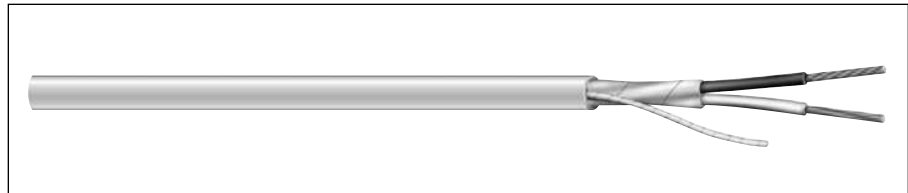

CATALOG NUMBER	NO. OF COND.	AWG SIZE	COND. STRAND	NOM. INSULATION THICKNESS		NOM. JACKET WALL		NOMINAL O.D.	
				INCHES	mm	INCHES	mm	INCHES	mm
E2482S	2	22	Solid	0.010	0.25	0.015	0.38	0.126	3.20
E2484S	4	22	Solid	0.010	0.25	0.015	0.38	0.145	3.68
E2502S	2	18	Solid	0.010	0.25	0.015	0.38	0.158	4.01
E2503S	3	18	Solid	0.010	0.25	0.015	0.38	0.165	4.19
E2504S	4	18	Solid	0.010	0.25	0.015	0.38	0.183	4.65
E2506S	6	18	Solid	0.010	0.25	0.015	0.38	0.216	5.49
E2508S	8	18	Solid	0.010	0.25	0.015	0.38	0.235	5.97
E2522S	2	16	Solid	0.010	0.25	0.015	0.38	0.180	4.57
E2524S	4	16	Solid	0.010	0.25	0.015	0.38	0.210	5.33
E2532S*	2	14	Solid	0.013	0.33	0.015	0.38	0.218	5.54
E2534S*	4	14	Solid	0.013	0.33	0.015	0.38	0.253	6.43
E2542S*	2	12	Solid	0.013	0.33	0.015	0.38	0.252	6.40
E2544S*	4	12	Solid	0.013	0.33	0.015	0.38	0.293	7.44

* NEC FPLR/CL3R only.
Data subject to change.

Color Code Chart

NO. OF COND.	COLOR
1	Black
2	Red
3	Brown
4	Blue
5	Orange
6	Yellow
7	Purple
8	Gray

Multi-Conductor, Shielded, Non-Plenum

CSA FAS105, FPL (UL), NEC Type PLTC

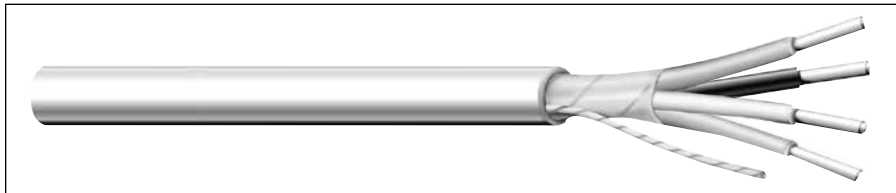

CATALOG NUMBER	NO. OF COND.	AWG SIZE	COND. STRAND	DRAIN WIRE AWG	NOM. INSULATION THICKNESS		NOM. JACKET THICKNESS		NOMINAL O.D.	
					INCHES	mm	INCHES	mm	INCHES	mm
C4334A	2	18	Solid	22	0.015	0.38	0.042	1.07	0.230	5.84
C4335A	3	18	Solid	22	0.015	0.38	0.042	1.07	0.241	6.12
C4336A	4	18	Solid	22	0.015	0.38	0.042	1.07	0.260	6.60
C4337A	5	18	Solid	22	0.015	0.38	0.042	1.07	0.279	7.09
C4338A	6	18	Solid	22	0.015	0.38	0.042	1.07	0.301	7.65
C4339A	7	18	Solid	22	0.015	0.38	0.042	1.07	0.301	7.65
C4340A	8	18	Solid	22	0.015	0.38	0.042	1.07	0.322	8.18
C4341A	9	18	Solid	22	0.015	0.38	0.042	1.07	0.344	8.74
C4342A	10	18	Solid	22	0.015	0.38	0.042	1.07	0.371	9.42
C4343A	30	18	Solid	22	0.015	0.38	0.053	1.35	0.563	14.30
C4344A	2	16	Solid	22	0.015	0.38	0.042	1.07	0.251	6.37
C4345A	3	16	Solid	22	0.015	0.38	0.042	1.07	0.263	6.68
C4346A	4	16	Solid	22	0.015	0.38	0.042	1.07	0.285	7.24
C4350A	5	16	Solid	22	0.015	0.38	0.042	1.07	0.307	7.80
C4347A	2	14	Solid	16	0.015	0.38	0.042	1.07	0.277	7.04
C4348A	2	12	Solid	16	0.020	0.51	0.042	1.07	0.331	8.41

Data subject to change.

Product Construction:

Conductor:

- 18-12 AWG fully annealed, solid bare copper per ASTM B3

Insulation:

- Premium-grade, color-coded PVC
- Color code: See page 229 for the CSA Fire Alarm Color Code Chart

Shield:

- 100% Flexfoil® aluminum/polyester with 25% overlap, foil facing out
- Stranded tinned copper drain wire

Jacket:

- Premium-grade PVC, red
- Temperature range: -20°C to +105°C
- TRU-Mark® print legend contains footage markings from 1000' to 0'

Applications:

- Wiring of fire alarms
- Smoke alarms
- Voice communications
- Burglar alarms
- Fire protective circuits
- Suggested voltage rating: 300 volts

Compliances:

- NEC Article 725 PLTC (UL: 105°C, 300 V)
- NEC Article 760 Type FPL (UL: 105°C, 300 V)
- CSA FAS105 (CSA: 105°C, 300 V)
- C22.2 No. 208-03 (R2008) Weather (Sunlight) Resistant (1,000 HR)
- RoHS Compliant Directive 2011/65/EU
- Designed to meet UL 70,000 BTU Vertical Tray Flame Test
- Passes CSA FT4 Vertical Flame Test
- CE: Low Voltage Directive (LVD) 2006/95/EC

Packaging:

- Please contact Customer Service for packaging and color options



Multi-Conductor, Unshielded, Plenum

NEC Type FPLP and CL3P, NEC/CEC Type CMP

Product Construction:

Conductor:

- 22 thru 12 AWG fully annealed solid bare copper per ASTM B3

Insulation:

- Premium-grade, color-coded Flexguard® PVC
- Color code: See chart below

Jacket:

- Premium-grade Flexguard® PVC, red
- Temperature range: 0°C to +75°C
- Sequential footage markings to facilitate installation
- Includes ripcord

Applications:

- Wiring of fire alarms
- Smoke detectors
- Voice communications
- Burglar alarms
- Fire protective circuits
- Suggested voltage rating: 300 volts

Compliances:

- NEC Article 760 Type FPLP (UL: 75°C, 300 V)
- NEC Article 725 Type CL3P (UL: 75°C, 300 V)
- NEC Article 800 Type CMP (UL: 75°C, 300 V)
- Suitable for use in the State of California
- RoHS Compliant Directive 2011/65/EU
- Designed to meet NFPA 262 and CSA FT6 Steiner Tunnel Fire Tests for Plenum Applications

Packaging:

- Please contact Customer Service for packaging and color options

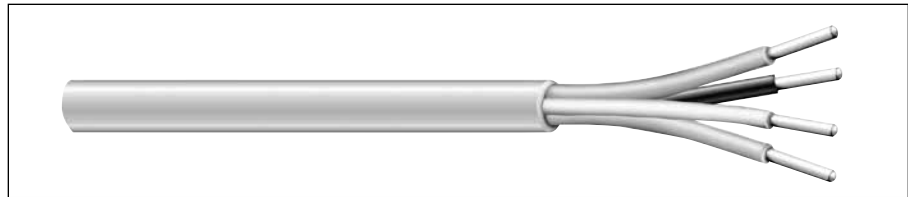

CATALOG NUMBER	NO. OF COND.	AWG SIZE	COND. STRAND	NOM. INSULATION THICKNESS		NOM. JACKET WALL		NOMINAL O.D.	
				INCHES	mm	INCHES	mm	INCHES	mm
E3482S	2	22	Solid	0.010	0.25	0.015	0.38	0.121	3.07
E3484S	4	22	Solid	0.010	0.25	0.015	0.38	0.137	3.47
E3502S	2	18	Solid	0.010	0.25	0.015	0.38	0.155	3.81
E3503S	3	18	Solid	0.010	0.25	0.015	0.38	0.160	4.06
E3504S	4	18	Solid	0.010	0.25	0.015	0.38	0.175	4.45
E3506S	6	18	Solid	0.010	0.25	0.015	0.38	0.211	5.36
E3512S	2	16	Solid	0.010	0.25	0.015	0.38	0.172	4.37
E3514S	4	16	Solid	0.010	0.25	0.015	0.38	0.202	5.13
E3522S*	2	14	Solid	0.012	0.30	0.015	0.38	0.205	5.21
E3524S*	4	14	Solid	0.012	0.30	0.015	0.38	0.243	6.17
E3532S*	2	12	Solid	0.012	0.30	0.015	0.38	0.244	6.20
E3534S*	4	12	Solid	0.012	0.30	0.015	0.38	0.284	7.21

* NEC FPLP/CL3P only.
Data subject to change.

Color Code Chart

NO. OF COND.	COLOR
1	Black
2	Red
3	Brown
4	Blue
5	Orange
6	Yellow

Multi-Conductor, Unshielded, Plenum

NEC Type FPLP, PVDF Jacketed

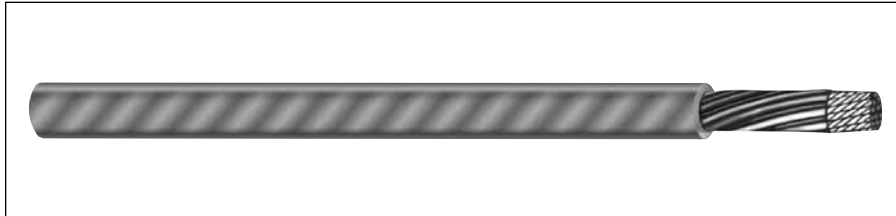

CATALOG NUMBER	NO. OF COND	AWG SIZE	COND. STRAND	NOM. INSULATION THICKNESS		NOM. JACKET THICKNESS		NOMINAL O.D.		NOM.* C-C CAP. pF/ft
				IN	mm	IN	mm	IN	mm	
C3200	2	18	Solid	0.010	0.23	0.010	0.25	0.140	3.56	29.0
C3201	4	18	Solid	0.010	0.23	0.010	0.25	0.156	3.96	29.0
C3210	2	16	Solid	0.010	0.23	0.010	0.25	0.133	3.38	31.0
C3211	4	16	Solid	0.010	0.23	0.010	0.25	0.186	4.72	31.0
C3220	2	14	Solid	0.013	0.31	0.010	0.25	0.170	4.32	31.0
C3223	4	14	Solid	0.013	0.31	0.010	0.25	0.224	5.69	31.0
C3224	2	12	Solid	0.013	0.31	0.010	0.25	0.194	4.93	35.0
C3225	4	12	Solid	0.013	0.31	0.010	0.25	0.261	6.63	35.0

*Capacitance between conductors
Data subject to change.

Color Code Chart

NO. OF COND.	COLOR
1	Black
2	Red
3	Brown
4	Blue

Product Construction

Conductor:

- 18 thru 12 AWG fully annealed solid bare copper to ASTM B3

Insulation:

- Premium-grade, color-coded ECTFE (Halar)
- Color code: See chart below

Jacket:

- PVDF, red
- Abrasion-, chemical- and water-resistant
- Temperature range: -30°C to +150°C
- Includes ripcord

Applications:

- Fire alarm systems
- Voice communications
- Smoke detectors
- Pull boxes
- Suggested voltage rating: 300 volts

Compliances:

- NEC Article 760 Type FPLP (UL: 125°C, 300 V)
- Suitable for use in the State of California
- Designed to meet NFPA 262 and CSA FT6 Steiner Tunnel Fire Tests for Plenum Applications

Features:

- Sequential footage marking

Packaging:

- Please contact Customer Service for packaging and color options



Designed to Meet
NFPA 262 and CSA FT6
Steiner Tunnel Fire Tests
for Plenum Applications

Underwriters Laboratories Inc.



Multi-Conductor, Shielded, Plenum NEC Type FPLP

Product Construction:

Conductor:

- 22 thru 12 AWG fully annealed solid bare copper per ASTM B3

Insulation:

- Premium-grade, color-coded Flexguard® PVC
- Color code: See chart below

Shield:

- Overall Flexfoil® polyester supported aluminum foil
- Stranded tinned copper drain wire

Jacket:

- Premium-grade Flexguard® PVC, red
- Suitable for use from 0°C to +75°C
- Sequential footage markings to facilitate installation
- Includes ripcord

Applications:

- Wiring of fire alarms
- Smoke detectors
- Voice communications
- Burglar alarms
- Fire protective circuits
- Suggested voltage rating: 300 volts

Compliances:

- NEC Article 760 Type FPLP (UL: 75°C, 300 V)
- NEC Article 725 Type CL3P (UL: 75°C, 300 V)
- NEC Article 800 Type CMP (UL: 75°C, 300 V)
- Suitable for use in the State of California
- Designed to meet NFPA 262 and CSA FT6 Steiner Tunnel Fire Tests for Plenum Applications

Packaging:

- Please contact Customer Service for packaging and color options

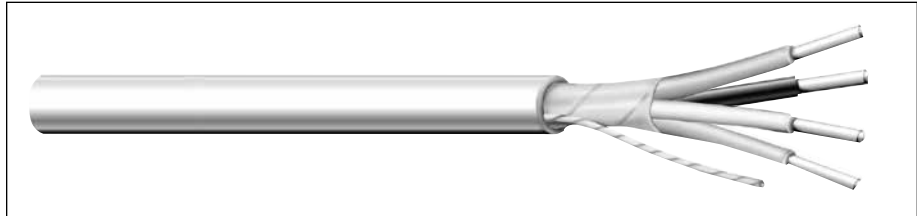

CATALOG NUMBER	NO. OF COND.	AWG SIZE	COND. STRAND	NOM. INSULATION THICKNESS		NOM. JACKET WALL		NOMINAL O.D.	
				INCHES	mm	INCHES	mm	INCHES	mm
E3542S	2	22	Solid	0.010	0.25	0.015	0.38	0.126	3.20
E3602S	2	18	Solid	0.010	0.25	0.015	0.38	0.158	4.01
E3603S	3	18	Solid	0.010	0.25	0.015	0.38	0.165	4.19
E3604S	4	18	Solid	0.010	0.25	0.015	0.38	0.183	4.65
E3606S	6	18	Solid	0.010	0.25	0.015	0.38	0.216	5.49
E3612S	2	16	Solid	0.010	0.25	0.015	0.38	0.180	4.57
E3614S	4	16	Solid	0.010	0.25	0.015	0.38	0.210	5.33
E3622S	2	14	Solid	0.012	0.30	0.015	0.38	0.210	5.33
E3624S	4	14	Solid	0.012	0.30	0.015	0.38	0.248	6.30
E3632S	2	12	Solid	0.012	0.30	0.015	0.38	0.252	6.40
E3634S	4	12	Solid	0.012	0.30	0.015	0.38	0.300	7.62

Data subject to change.

Color Code Chart

NO. OF COND.	COLOR
1	Black
2	Red
3	Brown
4	Blue
5	Orange
6	Yellow

Multi-Conductor, Shielded, Plenum

NEC Type FPLP, PVDF Jacketed



CATALOG NUMBER	NO. OF COND.	AWG SIZE	COND. STRAND	NOM. INSULATION THICKNESS		NOM. JACKET THICKNESS		NOMINAL O.D.		NOMINAL CAP. * pF/ft	
				INCHES	mm	INCHES	mm	INCHES	mm	A	B
C3260	2	18	Solid	0.010	0.25	0.010	0.25	0.149	3.78	50.5	90.8
C3261	4	18	Solid	0.010	0.25	0.010	0.25	0.168	4.27	44.5	80.0
C3270	2	16	Solid	0.010	0.25	0.010	0.25	0.169	4.29	58.0	104.0
C3271	4	16	Solid	0.010	0.25	0.010	0.25	0.194	4.93	50.0	90.0
C3280	2	14	Solid	0.013	0.33	0.010	0.25	0.214	5.44	55.5	100.0
C3284	4	14	Solid	0.013	0.33	0.010	0.25	0.245	6.22	48.0	87.0
C3282	2	12	Solid	0.013	0.33	0.010	0.25	0.234	5.94	65.0	116.0
C3283	4	12	Solid	0.013	0.33	0.010	0.25	0.284	7.21	55.0	99.0

*A - Capacitance between conductors

*B - Capacitance between one conductor and other conductors connected to shield

Data subject to change.

Color Code Chart

NO. OF COND.	COLOR
1	Black
2	Red
3	Brown
4	Blue

Product Construction

Conductor:

- 18 thru 12 AWG fully annealed solid bare copper per ASTM B3

Insulation:

- Premium-grade, color-coded ECTFE (Halar)
- Color code: See chart below

Shield:

- 100% Flexfoil® aluminum/polyester foil, 25% overlap, minimum
- Stranded tinned copper drain wire

Jacket:

- Fluoropolymer, red
- Abrasion-, chemical-resistant
- Temperature range: -40°C to +150°C
- Includes ripcord
- Sequential footage markings to facilitate installation

Applications:

- Fire alarm systems
- Voice communications
- Smoke detectors
- Pull boxes
- Suggested voltage rating: 300 volts

Compliances:

- NEC Article 760 Type FPLP (UL: 150°C, 300 V)
- Suitable for use in the State of California

Packaging:

- Please contact Customer Service for packaging and color options



Mid-Capacitance, Unshielded, Non-Plenum

NEC Type FPL for Microprocessor-Controlled Systems

Product Construction:

Conductor:

- 18 thru 12 AWG fully annealed solid bare copper per ASTM B3

Insulation:

- Premium-grade, color-coded polypropylene
- Color code: See chart below

Jacket:

- PVC, red
- Temperature range: -20°C to +75°C

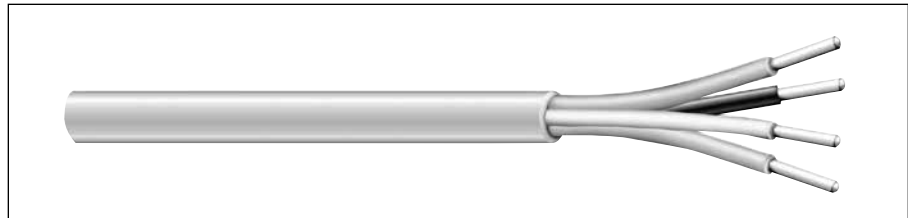

Applications:

- Addressable fire alarm systems
- Fire alarm systems
- Voice communications
- Smoke detectors
- Pull boxes
- Suggested voltage rating: 300 volts

Compliances:

- NEC Article 760 Type FPL (UL: 60°C, 300 V)
- Suitable for use in the State of California
- RoHS Compliant Directive 2011/65/EU
- Passes UL 70,000 BTU Vertical Tray Flame Test
- CE: Low Voltage Directive (LVD) 2006/95/EC

Packaging:

- Please contact Customer Service for packaging and color options

CATALOG NUMBER	NO. OF COND	AWG SIZE	COND. STRAND	NOM. INSULATION THICKNESS		NOM. JACKET THICKNESS		NOMINAL O.D.		NOM.* C-C CAP. pF/ft
				IN	mm	IN	mm	IN	mm	
C0471	2	18	Solid	0.014	0.36	0.020	0.51	0.177	4.50	16.5
C0485	4	18	Solid	0.014	0.36	0.020	0.51	0.205	5.21	16.5
C0473	2	16	Solid	0.016	0.41	0.020	0.51	0.206	5.23	17.5
C0486	4	16	Solid	0.016	0.41	0.020	0.51	0.240	6.10	17.5
C0491	2	14	Solid	0.018	0.46	0.020	0.51	0.240	6.10	18.0
C0492	2	12	Solid	0.020	0.51	0.020	0.51	0.282	7.16	19.0

*Capacitance between conductors
Data subject to change.

Color Code Chart

NO. OF COND.	COLOR
1	Black
2	Red
3	Brown
4	Blue

Mid-Capacitance, Shielded, Non-Plenum

NEC Type FPL for Microprocessor-Controlled Systems



CATALOG NUMBER	NO. OF COND.	AWG SIZE	COND. STRAND	NOM. INSULATION THICKNESS		NOM. JACKET THICKNESS		NOMINAL O.D.		NOMINAL CAP. * pF/ft	
				INCHES	mm	INCHES	mm	INCHES	mm	A	B
C0472	2	18	Solid	0.014	0.36	0.020	0.51	0.182	4.88	27.0	49.0
C0494	4	18	Solid	0.014	0.36	0.020	0.51	0.210	5.33	24.5	44.0
C0474	2	16	Solid	0.016	0.41	0.020	0.51	0.214	5.44	29.0	52.0
C0495	4	16	Solid	0.016	0.41	0.020	0.51	0.246	6.25	26.0	46.5
C0475	2	14	Solid	0.018	0.46	0.020	0.51	0.245	6.22	31.0	55.5
C0496	4	14	Solid	0.018	0.46	0.020	0.51	0.287	7.29	27.5	49.5
C0476	2	12	Solid	0.020	0.51	0.020	0.51	0.287	7.29	33.0	60.0
C0497	4	12	Solid	0.020	0.51	0.020	0.51	0.337	8.56	29.0	52.5

*A - Capacitance between conductors
 *B - Capacitance between one conductor and other conductors connected to shield
 Data subject to change.

Color Code Chart

NO. OF COND.	COLOR
1	Black
2	Red
3	Brown
4	Blue

Product Construction:

- Conductor:**
- 18 thru 12 AWG fully annealed solid bare copper per ASTM B3

- Insulation:**
- Premium-grade, color-coded polypropylene
 - Color code: See chart below

- Shield:**
- 100% Flexfoil® aluminum/polyester, 25% overlap, minimum
 - Stranded tinned copper drain wire

- Jacket:**
- PVC, red
 - Temperature range: 0°C to +75°C

- Applications:**
- Addressable fire alarm systems
 - Fire alarm systems
 - Voice communications
 - Smoke detectors
 - Pull boxes
 - Suggested voltage rating: 300 volts

- Compliances:**
- NEC Article 760 Type FPL (UL: 60°C, 300 V)
 - Suitable for use in the State of California
 - RoHS Compliant Directive 2011/65/EU
 - Passes UL 70,000 BTU Vertical Tray Flame Test

- Packaging:**
- Please contact Customer Service for packaging and color options

Mid-Capacitance, Unshielded, Plenum

NEC Type FPLP for Microprocessor-Controlled Systems

Product Construction:

Conductor:

- 18 thru 12 AWG fully annealed solid bare copper per ASTM B3

Insulation:

- Premium-grade, color-coded fluoropolymer
- Color code: See chart below

Jacket:

- Premium-grade Flexguard® PVC, red
- Temperature range: 0°C to +75°C
- Includes ripcord

Applications:

- Addressable fire alarm systems
- Fire alarm systems
- Voice communications
- Smoke detectors
- Pull boxes
- Suggested voltage rating: 300 volts

Compliances:

- NEC Article 760 Type FPLP (UL: 75°C, 300 V)
- Suitable for use in the State of California
- Designed to meet NFPA 262 and CSA FT6 Steiner Tunnel Fire Tests for Plenum Applications

Packaging:

- Please contact Customer Service for packaging and color options

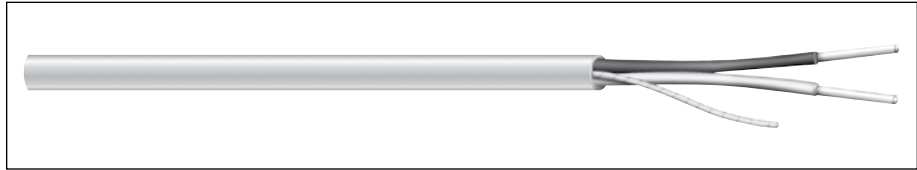

CATALOG NUMBER	NO. OF COND	AWG SIZE	COND. STRAND	NOM. INSULATION THICKNESS		NOM. JACKET THICKNESS		NOMINAL O.D.		NOM.* C-C CAP. pF/ft
				IN	mm	IN	mm	IN	mm	
C3240	2	18	Solid	0.014	0.36	0.015	0.38	0.172	4.37	19.0
C3242	4	18	Solid	0.014	0.36	0.015	0.38	0.195	4.95	19.0
C3241	2	16	Solid	0.016	0.41	0.015	0.38	0.196	4.98	20.0
C3243	4	16	Solid	0.016	0.41	0.015	0.38	0.231	5.87	20.0
C3244	2	14	Solid	0.018	0.46	0.020	0.51	0.242	6.15	20.0
C3245	4	14	Solid	0.018	0.46	0.020	0.51	0.286	7.26	20.0
C3246	2	12	Solid	0.020	0.51	0.020	0.51	0.282	7.16	22.0
C3247	4	12	Solid	0.020	0.51	0.020	0.51	0.333	8.45	22.0

*Capacitance between conductors
Data subject to change.

Color Code Chart

NO. OF COND.	COLOR
1	Black
2	Red
3	Brown
4	Blue

Mid-Capacitance, Shielded, Plenum

NEC Type FPLP for Microprocessor-Controlled Systems

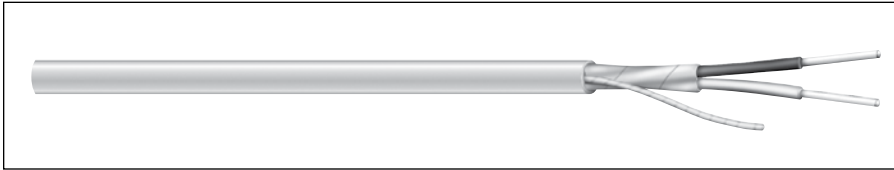

CATALOG NUMBER	NO. OF COND.	AWG SIZE	COND. STRAND	NOM. INSULATION THICKNESS		NOM. JACKET THICKNESS		NOMINAL O.D.		NOMINAL CAP. * pF/ft	
				INCHES	mm	INCHES	mm	INCHES	mm	A	B
C3167	2	18	Solid	0.014	0.36	0.015	0.38	0.172	4.37	31.0	56.0
C3170	4	18	Solid	0.014	0.36	0.015	0.38	0.202	5.13	28.0	50.0
C3169	2	16	Solid	0.016	0.41	0.015	0.38	0.203	5.16	33.0	59.0
C3171	4	16	Solid	0.016	0.41	0.015	0.38	0.238	6.05	29.0	53.0
C3172	2	14	Solid	0.018	0.46	0.020	0.51	0.247	6.27	35.0	63.0
C3173	4	14	Solid	0.018	0.46	0.020	0.51	0.289	7.34	30.0	56.0
C3174	2	12	Solid	0.020	0.51	0.020	0.51	0.289	7.34	38.0	68.0
C3175	4	12	Solid	0.020	0.51	0.020	0.51	0.340	8.64	33.0	60.0

*A - Capacitance between conductors

*B - Capacitance between one conductor and other conductors connected to shield

Data subject to change.

Color Code Chart

NO. OF COND.	COLOR
1	Black
2	Red
3	Brown
4	Blue

Product Construction

Conductor:

- 18 thru 12 AWG fully annealed solid bare copper per ASTM B3

Insulation:

- Premium-grade, color-coded fluoropolymer
- Color code: See chart below

Shield:

- 100% Flexfoil® aluminum/polyester foil, 25% overlap, minimum
- Stranded tinned copper drain wire

Jacket:

- Premium-grade Flexguard® PVC, red
- Temperature range: 0°C to +75°C
- Includes ripcord

Applications:

- Addressable fire alarm systems
- Fire alarm systems
- Voice communications
- Smoke detectors
- Pull boxes
- Suggested voltage rating: 300 volts

Compliances:

- NEC Article 760 Type FPLP (UL: 75°C, 300 V)
- Suitable for use in the State of California
- Designed to meet NFPA 262 and CSA FT6 Steiner Tunnel Fire Tests for Plenum Applications

Packaging:

- Please contact Customer Service for packaging and color options



Designed to Meet
NFPA 262 and CSA FT6
Steiner Tunnel Fire Tests
for Plenum Applications

Underwriters Laboratories Inc.



Multi-Paired, Unshielded, Non-Plenum

CSA FAS105, FPL (UL), NEC Type PLTC

Product Construction

Conductor:

- 22 and 18 AWG fully annealed solid bare copper per ASTM B3
- Twisted pairs

Insulation:

- Premium-grade, color-coded PVC
- Color code: See page 229 for the CSA Fire Alarm Color Code Chart

Jacket:

- Premium-grade PVC, red
- Temperature range: -20°C to +105°C
- TRU-Mark® print legend contains footage markings from 1000' to 0'



Applications:

- Wiring of fire alarms
- Smoke alarms
- Voice communications
- Burglar alarms
- Fire protection circuits
- Suggested voltage rating: 300 volts

Compliances:

- NEC Article 725 PLTC (UL: 105°C, 300 V)
- NEC Article 760 Type FPL (UL: 105°C, 300 V)
- CSA FAS105 (CSA: 105°C, 300 V)
- C22.2 No. 208-03 (R2008) Weather (Sunlight) Resistant (1,000 HR)
- RoHS Compliant Directive 2011/65/EU
- Designed to meet UL 70,000 BTU Vertical Tray Flame Test
- Passes CSA FT4 Vertical Flame Test
- CE: Low Voltage Directive (LVD) 2006/95/EC

CATALOG NUMBER	NO. OF PAIRS	AWG SIZE	COND. STRAND	NOM. INSULATION THICKNESS		NOM. JACKET THICKNESS		NOMINAL O.D.	
				INCHES	mm	INCHES	mm	INCHES	mm
C4328A	3	22	Solid	0.012	0.30	0.042	1.07	0.279	7.09
C4329A	6	22	Solid	0.012	0.30	0.042	1.07	0.350	8.89
C4330A	12	22	Solid	0.012	0.30	0.053	1.35	0.474	12.04
C4331A	15	22	Solid	0.012	0.30	0.053	1.35	0.523	13.28
C4332A	27	22	Solid	0.012	0.30	0.063	1.60	0.672	17.07
C4333A	6	18	Solid	0.015	0.38	0.053	1.35	0.487	12.37

Data subject to change.

Packaging:

- Please contact Customer Service for packaging and color options

Sound, Alarm & Security Cable

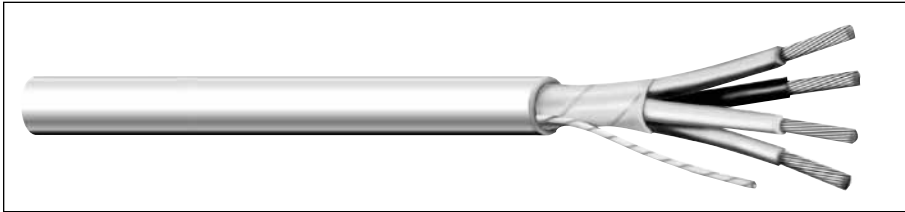

The sound and security industry in the United States has grown from a simple and unsophisticated business, begun some 45 years ago, to one which has developed technology to the degree that specialized wires and cables are now much in demand.

No longer are the security and sound industries characterized by large electromechanical relays and large contactors; today these circuits incorporate the latest in microprocessors and solid state devices to not only improve functionality but also to guarantee performance.

As a major wire producer, our role is to ensure that the wires and cables that go into these systems are as reliable as the other components ... the net result is a fully integrated system which will provide peace of mind to the system user.

Also in this section are General Cable's Carol® Brand wire and cable designs suitable for a variety of applications, both in industrial and commercial

environments, including telephone systems, intercoms, burglar alarms, business machines and thermostats.

Aside from the quality materials used in these designs, specifiers and users of Carol Brand wire and cable products have come to expect that these cables are registered and certified with the leading regulatory agencies such as Underwriters Laboratories ... and we haven't let you down!

Carol Brand designs have proven themselves in the area of sound and security over time; most are fabricated with solid or stranded, bare copper conductors with insulations and jackets of premium grades of PVC. We offer both parallel and cabled designs both with and without shields. Sequential footage markings on the jackets are offered on all products.

General Cable Carol Brand products are conveniently packaged in 1000' or 500' lengths to assist the installer.

Index	Page
Composite Access Control Cable, Plenum	113
Composite Access Control Cable, Riser	114
Multi-Conductor, Unshielded, Riser	115
Multi-Conductor, Shielded, Riser	116
Multi-Conductor, Unshielded, Plenum	117
Multi-Conductor, Shielded, Plenum	118
Telephone Station/Intercom & Speaker/Burglar Alarm	119
Low-Voltage Sprinkler Wire	120
Thermostat Wire Type LVT	121
Thermostat Wire Type CL2	122
Thermostat Wire, Unjacketed	123
Category 6 Cable	124
Category 5e Cable	125

Composite Access Control Cable, Plenum

NEC Type CMP, (UL), c(UL)

Product Construction:

Conductor:

- Stranded bare copper

Jacket:

- Flexguard® PVC
- Temperature range: 0°C to +60°C
- Individual elements marked for application (see diagram below)
- Yellow overall jacket

Shields:

- Choice between all 4 elements shielded or just the 3-pair element shielded

Applications:

- Security systems
- Access control
- Card reader
- Door control
- REX
- Power-limited controls

Compliances:

- NEC Article 800 Type CMP (UL), c(UL)
- RoHS Compliant Directive 2011/65/EU

Packaging:

- 500' and 1000' reels

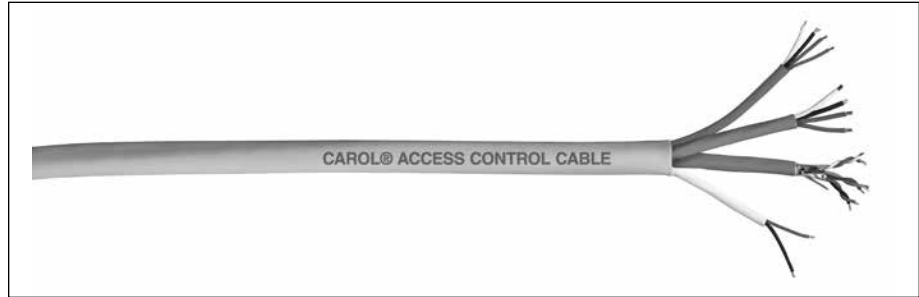

CATALOG NUMBER	OVERALL NOMINAL O.D. INCH (MM)	COMPONENT NO.	COMPONENT DESCRIPTIONS	CONDUCTORS COLOR CODE	COMPONENT NOMINAL O.D. INCH (MM)	INSULATION THICKNESS INCH (MM)
4EPL4S	0.430	1	4 Cond, 18 AWG, Shielded	White, Black, Red, Green	0.180 (4.572)	0.008 (0.2032)
		2	3 Pair, 22 AWG, Shielded	White & Green, Orange & Brown, Red & Black	0.195 (4.993)	0.008 (0.2032)
		3	2 Cond, 22 AWG, Shielded	Red, Black	0.125 (3.175)	0.008 (0.2032)
		4	4 Cond, 22 AWG, Shielded	White, Black, Red, Green	0.145 (3.683)	0.008 (0.2032)
4EPL1S	0.420	1	4 Cond, 18 AWG, Unshielded	White, Black, Red, Green	0.180 (4.572)	0.008 (0.2032)
		2	3 Pair, 22 AWG, Shielded	White & Green, Orange & Brown, Red & Black	0.195 (4.993)	0.008 (0.2032)
		3	2 Cond, 22 AWG, Unshielded	Red, Black	0.125 (3.175)	0.008 (0.2032)
		4	4 Cond, 22 AWG, Unshielded	White, Black, Red, Green	0.145 (3.683)	0.008 (0.2032)

Data subject to change.

Jacket Color Coding & Component Application

Jacket Color	Component	Cable Type	Application
Gray	1	4 Conductor, 18 AWG	Lock Power
Orange	2	3 Pair, 22 AWG	Card Reader
White	3	2 Conductor, 22 AWG	Door Contact
Blue	4	4 Conductor, 22 AWG	Rex/Spare

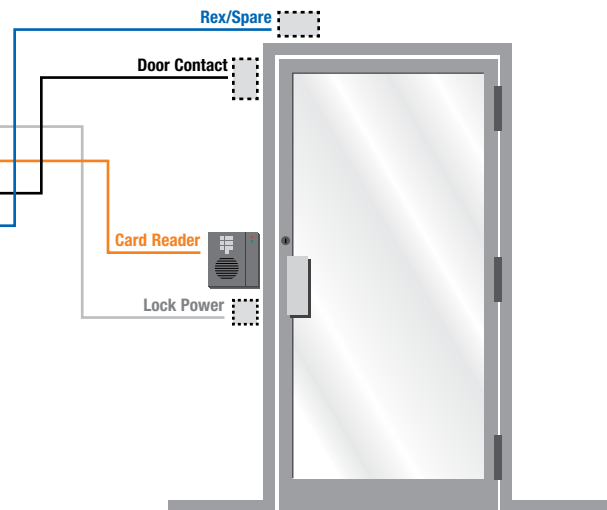

Composite Access Control Cable, Riser

NEC Type CMR, (UL), c(UL)

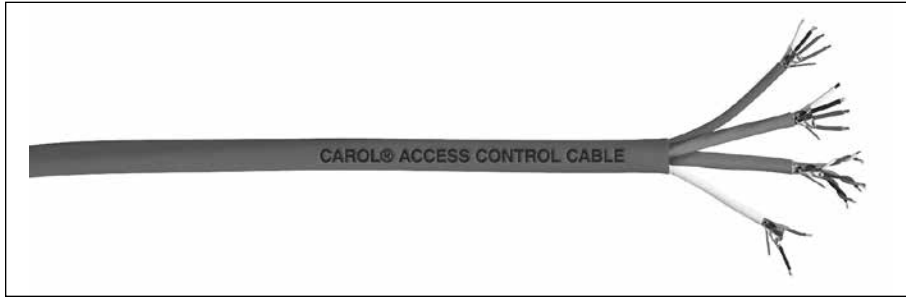

Product Construction:

Conductor:

- Stranded bare copper

Jacket:

- PVC
- Temperature range: -20°C to +60°C
- Individual elements marked for application (see diagram below)
- Blue overall jacket

Shields:

- Choice between all 4 elements shielded or just the 3-pair shielded

Applications:

- Security systems
- Access control
- Card reader
- Door control
- REX
- Power-limited controls

Compliances:

- NEC Article 800 Type CMR (UL), c(UL)
- RoHS Compliant Directive 2011/65/EU

Packaging:

- 500' and 1000' reels

CATALOG NUMBER	OVERALL NOMINAL O.D. INCH (MM)	COMPONENT NO.	COMPONENT DESCRIPTIONS	CONDUCTORS COLOR CODE	COMPONENT NOMINAL O.D. INCH (MM)	INSULATION THICKNESS INCH (MM)
4ERS4S	0.430	1	4 Cond, 18 AWG, Shielded	White, Black, Red, Green	0.180 (4.572)	0.008 (0.2032)
		2	3 Pair, 22 AWG, Shielded	White & Green, Orange & Brown, Red & Black	0.195 (4.953)	0.008 (0.2032)
		3	2 Cond, 22 AWG, Shielded	Red, Black	0.125 (3.175)	0.008 (0.2032)
		4	4 Cond, 22 AWG, Shielded	White, Black, Red, Green	0.145 (3.683)	0.008 (0.2032)
4ERS1S	0.420	1	4 Cond, 18 AWG, Unshielded	White, Black, Red, Green	0.180 (4.572)	0.008 (0.2032)
		2	3 Pair, 22 AWG, Shielded	White & Green, Orange & Brown, Red & Black	0.195 (4.953)	0.008 (0.2032)
		3	2 Cond, 22 AWG, Unshielded	Red, Black	0.125 (3.175)	0.008 (0.2032)
		4	4 Cond, 22 AWG, Unshielded	White, Black, Red, Green	0.145 (3.683)	0.008 (0.2032)

Data subject to change.

Jacket Color Coding & Component Application

Jacket Color	Component	Cable Type	Application
Gray	1	4 Conductor, 18 AWG	Lock Power
Orange	2	3 Pair, 22 AWG	Card Reader
White	3	2 Conductor, 22 AWG	Door Contact
Blue	4	4 Conductor, 22 AWG	Rex/Spare

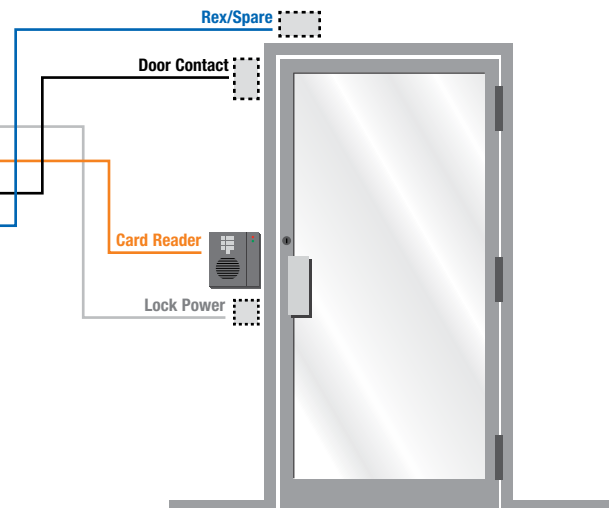

Multi-Conductor, Unshielded, Riser

NEC/CEC Type CMR and/or NEC Type CL3R and FPLR

Product Construction:

Conductor:

- Stranded or solid bare copper per ASTM B3, B8 and B286

Insulation:

- Premium-grade, color-coded S-R PVC
- Color code: See chart below

Jacket:

- Premium-grade PVC, gray
- Sequential footage markings to facilitate installation
- Temperature range: -20°C to +75°C
- Includes ripcord

Applications:

- Power-limited control circuits
- Wiring of the following systems:
 - Intercom
 - Security
 - Audio
 - Background music
- Suggested voltage rating: 300 volts

Compliances:

- NEC Article 725 Type CL3R (UL: 75°C, 150 V)
- NEC Article 800 Type CMR (UL: 75°C, 300 V)
- NEC Article 760 Type FPLR (UL: 75°C, 300 V)
- RoHS Compliant Directive 2011/65/EU
- Suitable for use in the State of California

Packaging:

- Please contact Customer Service for packaging and color options

Color Code Chart

NO. OF COND.	COLOR	NO. OF COND.	COLOR
1	Black	7	Orange
2	Red	8	Yellow
3	White	9	Purple
4	Green	10	Gray
5	Brown	11	Pink
6	Blue	12	Tan

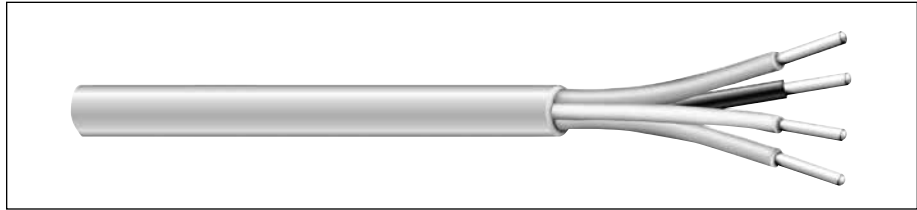

CATALOG NUMBER	NO. OF COND.	AWG SIZE	COND. STRAND	NOM. INSULATION THICKNESS		NOM. JACKET WALL		NOMINAL O.D.	
				INCHES	mm	INCHES	mm	INCHES	mm
E1000S	2	22	Solid	0.007	0.20	0.015	0.38	0.118	3.00
E1001S	4	22	Solid	0.007	0.20	0.015	0.38	0.126	3.20
E1002S	2	22	7/30	0.008	0.20	0.015	0.38	0.122	3.10
E1003S	3	22	7/30	0.008	0.20	0.015	0.38	0.141	3.58
E1004S	4	22	7/30	0.008	0.20	0.015	0.38	0.141	3.66
E1006S	6	22	7/30	0.008	0.20	0.015	0.38	0.164	4.17
E1008S	8	22	7/30	0.008	0.20	0.015	0.38	0.180	4.57
E1010S	10	22	7/30	0.008	0.20	0.015	0.38	0.212	5.38
E1012S	12	22	7/30	0.008	0.20	0.015	0.38	0.219	5.56
E1022S	2	20	7/28	0.007	0.18	0.008	0.20	0.134	3.40
E1023S	3	20	7/28	0.008	0.20	0.015	0.38	0.142	3.61
E1024S	4	20	7/28	0.008	0.20	0.015	0.38	0.156	3.96
E1030S	2	18	Solid	0.008	0.20	0.015	0.38	0.144	3.66
E1032S	2	18	7/26	0.008	0.20	0.015	0.38	0.154	3.91
E1033S	3	18	7/26	0.008	0.20	0.015	0.38	0.163	4.14
E1034S	4	18	7/26	0.008	0.20	0.015	0.38	0.180	4.57
E1036S	6	18	7/26	0.008	0.20	0.015	0.38	0.216	5.49
E1038S	8	18	7/26	0.008	0.20	0.015	0.38	0.245	6.22
E1040S	10	18	7/26	0.008	0.20	0.015	0.38	0.282	7.16
E1041S	12	18	7/26	0.009	0.23	0.015	0.38	0.291	7.39
E1042S	2	16	19/.0117	0.009	0.25	0.015	0.38	0.178	4.52
E1043S	3	16	19/.0117	0.009	0.25	0.015	0.38	0.193	4.90
E1044S	4	16	19/.0117	0.009	0.25	0.015	0.38	0.210	5.33
E1052S*	2	14	19/.0147	0.013	0.33	0.015	0.38	0.224	5.69
E1054S*	4	14	19/.0147	0.013	0.33	0.015	0.38	0.264	6.71
E1062S*	2	12	19/.0185	0.013	0.33	0.015	0.38	0.260	6.60
E1064S*	4	12	19/.0185	0.013	0.33	0.015	0.38	0.312	7.92

* NEC CL3R/FPLR only
Data subject to change.

Multi-Conductor, Shielded, Riser

NEC/CEC Type CMR and/or NEC Type CL3R and FPLR

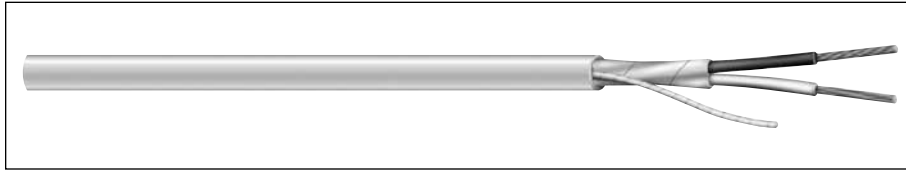

CATALOG NUMBER	NO. OF COND.	AWG SIZE	COND. STRAND	NOM. INSULATION THICKNESS		NOM. JACKET WALL		NOMINAL O.D.	
				INCHES	mm	INCHES	mm	INCHES	mm
E2000S	2	22	Solid	0.008	0.20	0.015	0.38	0.117	2.97
E2002S	2	22	7/30	0.008	0.20	0.015	0.38	0.132	3.35
E2003S	3	22	7/30	0.008	0.20	0.015	0.38	0.135	3.43
E2004S	4	22	7/30	0.008	0.20	0.015	0.38	0.147	3.73
E2006S	6	22	7/30	0.008	0.20	0.015	0.38	0.173	4.39
E2008S	8	22	7/30	0.008	0.20	0.015	0.38	0.195	4.95
E2010S	10	22	7/30	0.008	0.20	0.015	0.38	0.218	5.54
E2012S	12	22	7/30	0.010	0.25	0.008	0.20	0.222	5.64
E2022S	2	20	7/28	0.007	0.18	0.008	0.20	0.142	3.61
E2023S	3	20	7/28	0.007	0.18	0.008	0.20	0.151	3.84
E2024S	4	20	7/28	0.007	0.18	0.008	0.20	0.161	4.09
E2030S	2	18	Solid	0.009	0.20	0.008	0.20	0.147	3.73
E2032S	2	18	7/26	0.008	0.20	0.015	0.38	0.159	4.04
E2033S	3	18	7/26	0.008	0.20	0.015	0.38	0.168	4.27
E2034S	4	18	7/26	0.008	0.20	0.015	0.38	0.184	4.67
E2036S	6	18	7/26	0.008	0.20	0.015	0.38	0.221	5.61
E2038S	8	18	7/26	0.008	0.20	0.015	0.38	0.240	6.10
E2040S	10	18	7/26	0.008	0.20	0.015	0.38	0.287	7.29
E2041S	12	18	7/26	0.008	0.20	0.015	0.38	0.296	7.52
E2042S	2	16	19/.0117	0.009	0.23	0.015	0.38	0.189	4.80
E2043S	3	16	19/.0117	0.009	0.23	0.015	0.38	0.198	5.03
E2044S	4	16	19/.0117	0.009	0.23	0.015	0.38	0.219	5.56
E2052S*	2	14	19/.0147	0.013	0.33	0.015	0.38	0.245	6.22
E2054S*	4	14	19/.0147	0.013	0.33	0.015	0.38	0.269	6.83
E2062S*	2	12	19/.0185	0.013	0.33	0.015	0.38	0.281	7.14
E2064S*	4	12	19/.0185	0.013	0.33	0.015	0.38	0.312	7.92

* NEC CL3R/FPLR only
Data subject to change.

Product Construction:

Conductor:

- Stranded or solid bare copper per ASTM B3, B8 and B286

Insulation:

- Premium-grade, color-coded S-R PVC
- Color code: See chart below

Shield:

- Overall Flexfoil® polyester supported aluminum foil
- Stranded tinned copper drain wire

Jacket:

- Premium-grade PVC, gray
- Sequential footage markings to facilitate installation
- Temperature range: -20°C to +75°C
- Includes ripcord

Applications:

- Power-limited control circuits
- Wiring of the following systems:
 - Intercom
 - Security
 - Audio
 - Background music
- Suggested voltage rating: 300 volts

Compliances:

- NEC Article 725 Type CL3R (UL: 75°C, 300 V)
- NEC Article 800 Type CMR (UL: 75°C, 300 V)
- NEC Article 760 Type FPLR (UL: 75°C, 300 V)
- RoHS Compliant Directive 2011/65/EU
- Suitable for use in the State of California

Packaging:

- Please contact Customer Service for packaging and color options

Color Code Chart 5

NO. OF COND.	COLOR	NO. OF COND.	COLOR
1	Black	7	Orange
2	Red	8	Yellow
3	White	9	Purple
4	Green	10	Gray
5	Brown	11	Pink
6	Blue	12	Tan



Multi-Conductor, Unshielded, Plenum

NEC/CEC Type CMP and/or NEC Type CL3P and FPLP

Product Construction:

Conductor:

- Stranded or solid bare copper per ASTM B3, B8 and B286

Insulation:

- Premium-grade, color-coded Flexguard® PVC
- Color code: See chart below

Jacket:

- Premium-grade Flexguard® PVC, natural
- Sequential footage markings to facilitate installation
- Temperature range: 0°C to +75°C

Applications:

- Power-limited control circuits
- Wiring of the following systems:
 - Intercom
 - Security
 - Audio
 - Background music
- Suggested voltage rating: 300 volts

Compliances:

- NEC Article 725 Type CL3P (UL: 75°C, 150 V)
- NEC Article 800 Type CMP (UL: 75°C, 300 V)
- NEC Article 760 Type FPLP (UL: 75°C, 300 V)
- Designed to meet NFPA 262 Flame Test
- Suitable for use in the State of California

Packaging:

- Please contact Customer Service for packaging and color options

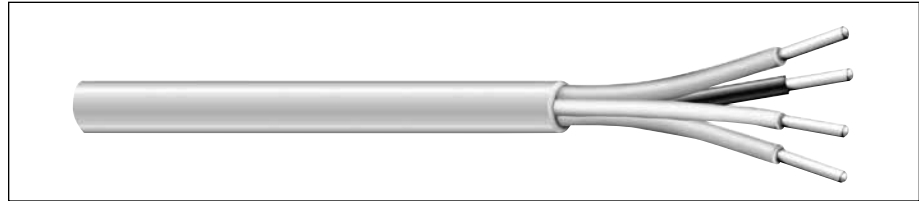

CATALOG NUMBER	NO. OF COND.	AWG SIZE	COND. STRAND	NOM. INSULATION THICKNESS		NOM. JACKET WALL		NOMINAL O.D.	
				INCHES	mm	INCHES	mm	INCHES	mm
E3000S	2	22	Solid	0.007	0.18	0.015	0.38	0.108	2.74
E3001S	4	22	Solid	0.007	0.18	0.015	0.38	0.124	3.15
E3002S	2	22	7/30	0.008	0.20	0.015	0.38	0.120	3.05
E3003S	3	22	7/30	0.008	0.20	0.015	0.38	0.127	3.23
E3004S	4	22	7/30	0.008	0.20	0.015	0.38	0.139	3.53
E3006S	6	22	7/30	0.008	0.20	0.015	0.38	0.164	4.17
E3008S	8	22	7/30	0.008	0.20	0.015	0.38	0.178	4.52
E3010S	10	22	7/30	0.008	0.20	0.015	0.38	0.194	4.92
E3012S	12	22	7/30	0.008	0.20	0.015	0.38	0.211	5.36
E3022S	2	20	7/28	0.009	0.23	0.008	0.20	0.134	3.40
E3023S	3	20	7/28	0.009	0.23	0.008	0.20	0.142	3.61
E3024S	4	20	7/28	0.009	0.23	0.008	0.20	0.156	3.96
E3030S	2	18	Solid	0.008	0.20	0.015	0.38	0.142	3.61
E3032S	2	18	7/26	0.008	0.20	0.015	0.38	0.156	3.96
E3033S	3	18	7/26	0.008	0.20	0.015	0.38	0.166	4.22
E3034S	4	18	7/26	0.008	0.20	0.015	0.38	0.187	4.75
E3036S	6	18	7/26	0.008	0.20	0.015	0.38	0.216	5.49
E3038S	8	18	7/26	0.008	0.20	0.015	0.38	0.235	5.97
E3042S	2	16	19/.0117	0.008	0.20	0.015	0.38	0.174	4.42
E3043S	3	16	19/.0117	0.008	0.20	0.015	0.38	0.185	4.70
E3044S	4	16	19/.0117	0.009	0.23	0.008	0.20	0.205	5.21
E3052S*	2	14	19/.0147	0.011	0.28	0.015	0.38	0.216	5.49
E3054S*	4	14	19/.0147	0.011	0.28	0.015	0.38	0.255	6.48
E3062S*	2	12	19/.0185	0.011	0.28	0.015	0.38	0.252	6.40
E3064S*	4	12	19/.0185	0.011	0.28	0.015	0.38	0.298	7.57

* NEC CL3P/FPLP only
Data subject to change.

Color Code Chart

NO. OF COND.	COLOR	NO. OF COND.	COLOR
1	Black	7	Orange
2	Red	8	Yellow
3	White	9	Purple
4	Green	10	Gray
5	Brown	11	Pink
6	Blue	12	Tan

Multi-Conductor, Shielded, Plenum

NEC/CEC Type CMP and/or NEC Type CL3P and FPLP

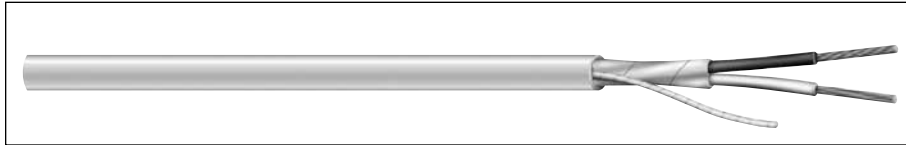

CATALOG NUMBER	NO. OF COND.	AWG SIZE	COND. STRAND	NOM. INSULATION THICKNESS		NOM. JACKET WALL		NOMINAL O.D.	
				INCHES	mm	INCHES	mm	INCHES	mm
E2100S	2	22	Solid	0.007	0.18	0.015	0.38	0.116	2.95
E2102S	2	22	7/30	0.008	0.20	0.015	0.38	0.128	3.25
E2103S	3	22	7/30	0.008	0.20	0.015	0.38	0.131	3.33
E2104S	4	22	7/30	0.008	0.20	0.015	0.38	0.147	3.73
E2106S	6	22	7/30	0.008	0.20	0.015	0.38	0.176	4.47
E2108S	8	22	7/30	0.008	0.20	0.015	0.38	0.184	4.67
E2110S	10	22	7/30	0.008	0.20	0.015	0.38	0.215	5.46
E2112S	12	22	7/30	0.008	0.20	0.015	0.38	0.222	5.64
E2122S	2	20	7/28	0.009	0.23	0.008	0.20	0.139	3.53
E2123S	3	20	7/28	0.009	0.23	0.008	0.20	0.147	3.73
E2124S	4	20	7/28	0.009	0.23	0.008	0.20	0.161	4.09
E2200S	2	18	Solid	0.008	0.20	0.015	0.38	0.148	3.76
E2202S	2	18	7/26	0.008	0.20	0.015	0.38	0.164	4.17
E2203S	3	18	7/26	0.008	0.20	0.015	0.38	0.169	4.29
E2204S	4	18	7/26	0.008	0.20	0.015	0.38	0.185	4.70
E2206S	6	18	7/26	0.010	0.25	0.008	0.20	0.218	5.54
E2208S	8	18	7/26	0.010	0.25	0.008	0.20	0.237	6.02
E2242S	2	16	19/.0117	0.008	0.20	0.015	0.38	0.179	4.55
E2243S	3	16	19/.0117	0.008	0.20	0.015	0.38	0.190	4.83
E2244S	4	16	19/.0117	0.008	0.20	0.015	0.38	0.209	5.31
E2252S*	2	14	19/.0147	0.008	0.20	0.011	0.28	0.235	5.97
E2254S*	4	14	19/.0147	0.008	0.20	0.011	0.28	0.260	6.60
E2262S*	2	12	19/.0185	0.008	0.20	0.011	0.28	0.257	6.53
E2264S*	4	12	19/.0185	0.008	0.20	0.011	0.28	0.303	7.70

* NEC CL3P/FPLP only
Data subject to change.

Product Construction:

Conductor:

- Stranded or solid bare copper per ASTM B3, B8 and B286

Insulation:

- Premium-grade, color-coded Flexguard® PVC

Shield:

- Overall Flexfoil® polyester supported aluminum foil
- Stranded tinned copper drain wire

Jacket:

- Premium-grade Flexguard® PVC, natural
- Sequential footage markings to facilitate installation
- Temperature range: 0°C to +75°C

Applications:

- Power-limited control circuits
- Wiring of the following systems:
 - Intercom
 - Security
 - Audio
 - Background music
- Suggested voltage rating: 300 volts

Compliances:

- NEC Article 725 Type CL3P (UL: 75°C, 150 V)
- NEC Article 800 Type CMP (UL: 75°C, 300 V)
- NEC Article 760 Type FPLP (UL: 75°C, 300 V)
- Designed to meet NFPA 262 Flame Test
- Suitable for use in the State of California

Packaging:

- Please contact Customer Service for packaging and color options

Color Code Chart

NO. OF COND.	COLOR
1	Black
2	Red
3	White
4	Green
5	Brown
6	Blue
7	Orange
8	Yellow
9	Purple
10	Gray
11	Pink
12	Tan



Telephone Station/Intercom & Speaker/Burglar Alarm

NEC Types CMR or CM/CL2 and CMX-Outdoor

Product Construction:

Conductor:

- Solid or stranded bare copper per ASTM B3

Insulation:

- Semi-rigid, flame-retardant PVC
- Color code: See chart below

Core:

- Conductors in a quad configuration (C4412)

Jacket:

- Low-temperature, flame-retardant beige PVC (-20°C to +60°C)
- Sequential footage markings
- Cables are suitable for installation with T-18 staples

Applications:

- Intercom systems and speaker extension service
- Suggested voltage rating: 300 volts
- **C4413 only:** Product is in conformance with TIA 568C, TIA 570B standards and the FCC Part 68 ruling which requires telephone system cables for voice and data services into homes to be at minimum category 3, 2 pr. 22 AWG solid

Compliances:

- NEC Article 800 Type CMR/CMX-Indoor/Outdoor; UL Listed (60°C, 300 V)
- C4413 only, Category 3
- RoHS Compliant Directive 2011/65/EU

Packaging:

- Please contact Customer Service for packaging and color options

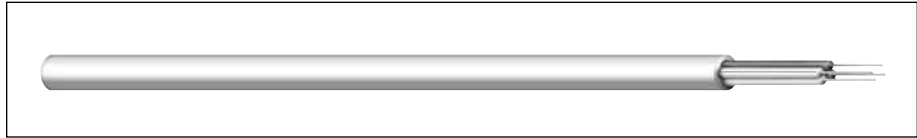

CATALOG NUMBER	NO. OF COND.	AWG SIZE	COND. STRAND	NOM. INSULATION THICKNESS		NOM. JACKET THICKNESS		NOMINAL O.D.	
				INCHES	mm	INCHES	mm	INCHES	mm

INTERCOM, SPEAKER AND BURGLAR ALARM

C4408*	2	22	Solid	0.007	0.18	0.020	0.51	0.115	2.92
C4408ST*	2	22	7/.0096	0.007	0.18	0.020	0.51	0.125	3.18
C4410	3	22	Solid	0.007	0.18	0.016	0.41	0.118	3.00
C4412*	4	22	Solid	0.007	0.18	0.015	0.38	0.125	3.18
C4412ST*	4	22	7/.0096	0.007	0.18	0.015	0.38	0.135	3.43

Color Code Chart

NO. OF COND.	COLOR	NO. OF COND.	COLOR
1	Red	3	Yellow
2	Green	4	Black

TELEPHONE STATION

CATEGORY 3

CATALOG NUMBER	NO. OF PAIRS	AWG SIZE	COND. STRAND	NOM. INSULATION THICKNESS		NOM. JACKET THICKNESS		NOMINAL O.D.	
				INCHES	mm	INCHES	mm	INCHES	mm

C4413	2	24	Solid	0.007	0.18	0.015	0.38	0.145 x 0.095	3.68 x 2.41
--------------	---	----	-------	-------	------	-------	------	---------------	-------------

Note: Outdoor rating allows cable to be exposed for short distances from the network interface device on the outside of the house to the point where the cable enters the house. This type of cable is not to be buried or direct buried.

Data subject to change.

Color Code Chart (Bandmarked)

NO. OF COND.	COLOR	NO. OF COND.	COLOR
1	White-Blue Band Blue	2	White-Orange Band Orange

Low-Voltage Sprinkler Wire

60°C 30 Volts UL



CATALOG NUMBER	NO. OF COND.	AWG SIZE	LENGTH OF CORD (FEET)	PACKAGE TYPE	POWER RATING ⁽¹⁾			PKG PER CTN.	APPROX. WEIGHT PER CTN (LBS) ^(S)	CARTON DIMENSIONS (H x W x D)	UPC NUMBER
					VOLTS	AMPS	WATTS				
LOW VOLTAGE SPRINKLER WIRE - 30 VOLTS - UL											
23824.60.01	4	18	100	Cuff	30	15	450	6	22	8.5 x 12.25 x 14	079407238248
23804.18.01	4	18	500	Spool	30	15	450	1	18	10.625 x 10.625 x 6.313	079407908047
23815.60.01	5	18	50	Cuff	30	15	450	6	13	8.5 x 12.25 x 14	079407238156
23825.60.01	5	18	100	Cuff	30	15	450	6	27	9.5 x 14 x 17	079407238255
23805.18.01	5	18	500	Spool	30	15	450	1	22	10.625 x 10.625 x 6.313	079407908054
23817.60.01	7	18	50	Cuff	30	15	450	6	18	8.5 x 12.25 x 14	079407238170
23827.60.01	7	18	100	Cuff	30	15	450	6	36	9.5 x 14 x 17	079407238279
23807.18.01	7	18	500	Spool	30	15	450	1	31	10.625 x 10.625 x 6.313	079407908078
23810.18.01	10	18	500	Reel	30	15	450	1	44	—	079407908108

(1) Amps and watts are offered ONLY as a guide to the end user.

(S) Actual shipping weight may vary.

Data subject to change.

Color Code Chart

NO. OF CONDUCTORS	COLOR
1	Black
2	White
3	Red
4	Green
5	Orange
6	Yellow
7	Blue
8	Brown
9	Gray
10	Purple

Product Construction:

Conductor:

- 18 AWG fully annealed solid bare copper per ASTM B3

Insulation:

- Premium-grade, color-coded PVC
- Premium-grade PE jacket, black
- Nylon rip cord to facilitate jacket removal
- Temperature range: -20°C to +60°C
- Color code: See chart at left

Jacket Marking:

- CAROL (SIZE) 30 V SPRINKLER SYSTEMS WIRE - DIRECT BURIAL E54567 (UL)

Applications:

- Low-voltage golf course satellite sprinkler control
- Residential sprinkler solenoid control

Compliances:

- UL Listed under a UL Miscellaneous Wire file
- UL Listed for outdoors applications
- UL Listed for direct burial applications

Packaging:

- See tabular data above
- Please contact Customer Service for packaging and color options



Thermostat Wire

60°C 30 Volt CSA Type LVT

Product Construction:

Conductors:

- 18 AWG annealed solid bare copper per ASTM B3

Insulation:

- Premium-grade, color-coded PVC
- Color code: See chart below

Jacket:

- Polyvinylchloride (PVC), brown
- Temperature range: -20°C to +60°C

Jacket Marking:

- CAROL (SIZE) CSA LL# TYPE LVT FT4

Applications:

- Thermostat control
- Heating and air conditioning installations
- Touch-plate systems
- Burglar alarms
- Intercom systems
- Door bells
- Annunciator and bell systems
- Remote control units
- Signal systems
- Other low-voltage installations

Industry Approvals:

- CSA Type LVT

Packaging:

- 4- through 10-conductor available on 250' (76.2 m) spools
- 2- and 3-conductor available on 500' (152.4 m) spools
- Other put-ups available on special order



18 AWG THERMOSTAT WIRE – 30 VOLT – CSA TYPE LVT

CATALOG NUMBER	NO. OF COND.	AWG SIZE	COND. STRAND	NOMINAL INS. THICKNESS		NOMINAL O.D.		APPROX. NET WEIGHT LBS/M ⁽⁵⁾	STD. CTN.
				INCHES	mm	INCHES	mm		
05092	2	18	Solid	0.016	0.41	0.210	5.33	25	2000'
05093*	3	18	Solid	0.016	0.41	0.220	5.59	33	500'
05094	4	18	Solid	0.016	0.41	0.242	6.15	41	1000'
05095	5	18	Solid	0.016	0.41	0.262	6.65	50	1000'
05096*	6	18	Solid	0.016	0.41	0.280	7.11	60	1000'
05097*	7	18	Solid	0.016	0.41	0.285	7.24	65	1000'
05098	8	18	Solid	0.016	0.41	0.304	7.75	74	1000'
05099*	9	18	Solid	0.016	0.41	0.328	8.33	83	1000'
05091*	10	18	Solid	0.016	0.41	0.360	9.14	92	250'

* Non-stock item; minimum quantity purchase required.
⁽⁵⁾ Actual shipping weight may vary.
 Data subject to change.

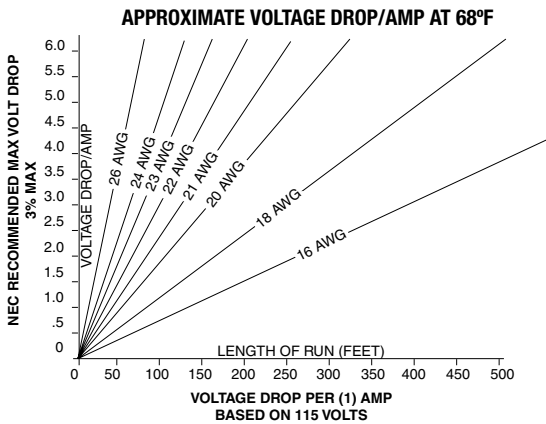

COLOR CODE CHART

NO. OF CONDUCTORS	COLOR
2	White, Red
3	White, Red, Green
4	White, Red, Green, Blue
5	White, Red, Green, Blue, Yellow
6	White, Red, Green, Blue, Yellow, Brown
7	White, Red, Green, Blue, Yellow, Brown, Orange
8	White, Red, Green, Blue, Yellow, Brown, Orange, Black
9	White, Red, Green, Blue, Yellow, Brown, Orange, Black, Purple
10	White, Red, Green, Blue, Yellow, Brown, Orange, Black, Purple, Gray

Thermostat Wire

105°C 150 Volt UL Type CL2

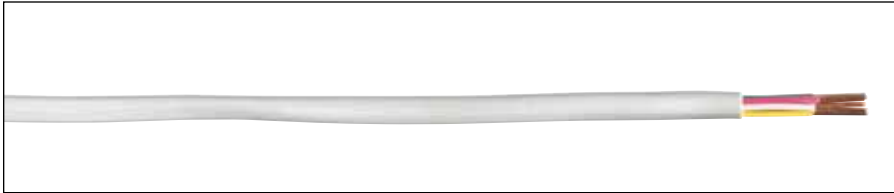

Product Construction:

Conductors:

- 20 and 18 AWG annealed solid bare copper per ASTM B3

Insulation:

- Premium-grade, color-coded PVC
- Color code: See chart below

Jacket:

- Polyvinylchloride (PVC), white
- Temperature range: -20°C to +105°C

Jacket Marking:

- CAROL AWG TYPE CL2 E# (UL) 105°C SUNLIGHT RESISTANT - MADE IN USA

Applications:

- Thermostat control
- Heating and air conditioning installations
- Touch-plate systems
- Burglar alarms
- Intercom systems
- Door bells
- Annunciator and bell systems
- Remote control units
- Signal systems
- Other low-voltage installations

Industry Approvals:

- UL Listed Type CL2
- RoHS Compliant

Packaging:

- 4- through 10-conductor available on 250' (76.2 m) spools
- 2- and 3-conductor available on 500' (152.4 m) spools
- Other put-ups available on special order

20 AWG THERMOSTAT WIRE – 150 VOLT – UL TYPE CL2

CATALOG NUMBER	NO. OF COND.	AWG SIZE	COND. STRAND	NOMINAL INS. THICKNESS		NOMINAL O.D.		APPROX. NET WEIGHT LBS/M ^(S)	STD. CTN.
				INCHES	mm	INCHES	mm		
05482	2	20	Solid	0.008	0.203	0.126	3.20	11	1000'
05483	3	20	Solid	0.008	0.203	0.133	3.38	16	1000'
05484	4	20	Solid	0.008	0.203	0.142	3.61	19	500'
05485	5	20	Solid	0.008	0.203	0.160	4.06	24	500'
05486	6	20	Solid	0.008	0.203	0.175	4.45	27	500'
05487	7	20	Solid	0.008	0.203	0.175	4.45	31	500'
05488	8	20	Solid	0.008	0.203	0.189	4.80	35	500'
05489*	9	20	Solid	0.008	0.203	0.204	5.18	40	500'
05481*	10	20	Solid	0.008	0.203	0.222	5.64	45	250'

18 AWG THERMOSTAT WIRE – 150 VOLT – UL TYPE CL2

CATALOG NUMBER	NO. OF COND.	AWG SIZE	COND. STRAND	NOMINAL INS. THICKNESS		NOMINAL O.D.		APPROX. NET WEIGHT LBS/M ^(S)	STD. CTN.
				INCHES	mm	INCHES	mm		
05582	2	18	Solid	0.008	0.203	0.142	3.61	16	1000'
05583	3	18	Solid	0.008	0.203	0.150	3.81	22	1000'
05584	4	18	Solid	0.008	0.203	0.165	4.19	28	500'
05585	5	18	Solid	0.008	0.203	0.181	4.60	36	500'
05586	6	18	Solid	0.008	0.203	0.208	5.28	42	500'
05587	7	18	Solid	0.008	0.203	0.208	5.28	48	500'
05588	8	18	Solid	0.008	0.203	0.225	5.72	54	500'
05589*	9	18	Solid	0.008	0.203	0.243	6.17	61	500'
05581	10	18	Solid	0.008	0.203	0.264	6.71	69	250'

^(S) Actual shipping weight may vary.
Data subject to change.

COLOR CODE CHART

NO. OF CONDUCTORS	COLOR
2	White, Red
3	White, Red, Green
4	White, Red, Green, Blue
5	White, Red, Green, Blue, Yellow
6	White, Red, Green, Blue, Yellow, Brown
7	White, Red, Green, Blue, Yellow, Brown, Orange
8	White, Red, Green, Blue, Yellow, Brown, Orange, Black
9	White, Red, Green, Blue, Yellow, Brown, Orange, Black, Purple
10	White, Red, Green, Blue, Yellow, Brown, Orange, Black, Purple, Gray

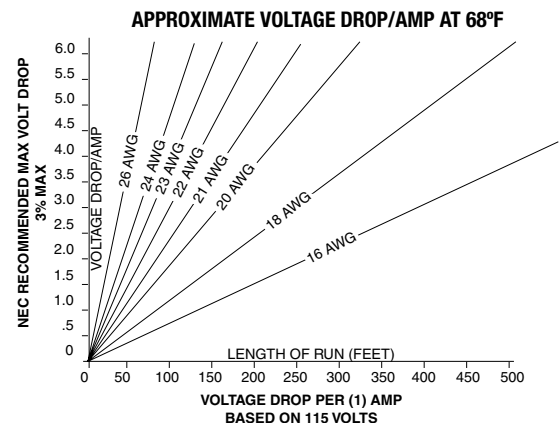

Thermostat Wire, Unjacketed

60°C Low Voltage and Intercom Cable

Product Construction:

Conductors:

- 20 AWG annealed solid bare copper per ASTM B3

Insulation:

- Premium-grade, color-coded PVC
- Temperature range: -20°C to +60°C
- Color code: See chart below

Jacket:

- This product is unjacketed

Applications:

- Thermostat control
- Heating and air conditioning installations
- Touch-plate systems
- Burglar alarms
- Intercom systems
- Door bells
- Annunciator and bell systems
- Remote control units
- Signal systems
- Other low-voltage installations

Packaging:

- 4- through 8-conductor available on 250' (76.2 m) spools
- 2- and 3-conductor available on 500' (152.4 m) spools
- Other put-ups available on special order

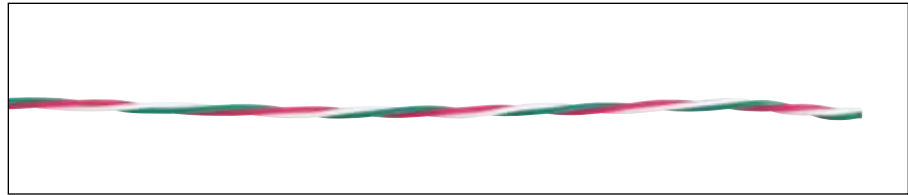

20 AWG – TWISTED CONDUCTORS – NO JACKET

CATALOG NUMBER	NO. OF COND.	AWG SIZE	COND. STRAND	NOMINAL INS. THICKNESS		NOMINAL O.D.		APPROX. NET WEIGHT LBS/M ^(S)	STD. CTN.
				INCHES	mm	INCHES	mm		
05782	2	20	Solid	0.008	0.203	0.096	2.44	7.5	4000'
05783	3	20	Solid	0.008	0.203	0.104	2.64	11.0	2000'
05784*	4	20	Solid	0.008	0.203	0.116	2.95	15.0	2000'
05785*	5	20	Solid	0.008	0.203	0.130	3.30	18.5	1000'
05786*	6	20	Solid	0.008	0.203	0.144	3.66	22.0	1000'
05788*	8	20	Solid	0.008	0.203	0.159	4.04	30.0	1000'

* Non-stock item; minimum quantity purchase required.

^(S) Actual shipping weight may vary.

Data subject to change.

COLOR CODE CHART

NO. OF CONDUCTORS	COLOR
2	White, Red
3	White, Red, Green
4	White, Red, Green, Blue
5	White, Red, Green, Blue, Yellow
6	White, Red, Green, Blue, Yellow, Brown
8	White, Red, Green, Blue, Yellow, Brown, Orange, Black

Category 6 Cable

Standard-Compliant Solution

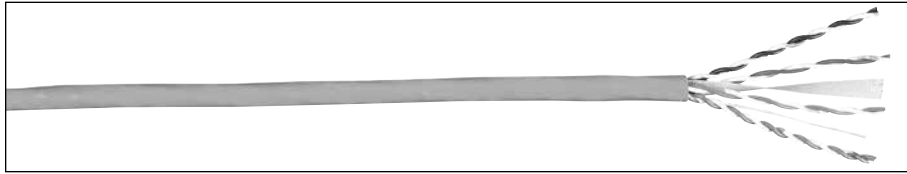

PART NUMBERS

JACKET COLOR	PULL-PAC® II		SPOOL-PAC®	
	CMR (NON-PLENUM)	CMP (PLENUM)	CMR (NON-PLENUM)	CMP (PLENUM)
Blue	CR6.30.07	CP6.30.07	CR6.A3.07	CP6.A3.07
White	CR6.30.02	CP6.30.02	CR6.A3.02	CP6.A3.02
Gray	CR6.30.10	CP6.30.10	CR6.A3.10	CP6.A3.10
Green	CR6.30.06	CP6.30.06	CR6.A3.06	CP6.A3.06
Yellow	CR6.30.05	CP6.30.05	CR6.A3.05	CP6.A3.05
Red	CR6.30.03	CP6.30.03	CR6.A3.03	CP6.A3.03

ELECTRICAL PERFORMANCE

FREQUENCY MHZ	PSACR (MIN)	ACR (MIN)	ATTENUATION (MAX)	PSNEXT (MIN)	NEXT (MIN)	PSELFEXT (MIN)	ELFEXT (MIN)	RETURN LOSS (MIN)	LCL (MIN)	ELTCTL (MIN)
1	70.3	72.3	2.0	72.3	74.3	64.8	67.8	20.0	40.0	35.0
4	59.3	61.5	3.8	63.3	65.3	52.8	55.7	23.0	40.0	23.0
10	51.3	53.3	6.0	57.3	59.3	44.8	47.8	25.0	40.0	15.0
16	46.7	48.7	7.6	54.2	56.2	40.7	43.7	25.0	38.0	10.9
20	44.3	46.3	8.5	52.8	54.8	38.8	41.7	25.0	37.0	9.0
31.25	39.2	41.2	10.7	49.9	51.9	34.9	37.9	23.6	35.1	5.1
62.5	29.9	32.0	15.4	45.4	47.4	28.9	31.8	21.5	32.0	5.0
100	22.5	24.5	19.8	42.3	44.3	24.8	27.8	20.1	30.0	5.0
150	14.9	16.9	24.7	39.7	41.7	21.3	24.3	18.9	28.2	5.0
200	8.8	10.8	29.0	37.8	39.8	18.8	21.8	18.0	27.0	5.0
250	3.5	5.5	32.8	36.3	38.3	16.8	19.8	17.3	26.0	5.0
350	—	—	39.8	34.1	36.1	13.9	16.9	16.3	—	—
400	—	—	43.0	33.3	35.3	12.8	15.8	15.9	—	—
500	—	—	48.9	31.8	33.8	10.8	13.8	15.2	—	—

Notes: Values are expressed in dB per 100m (328 ft.) length. Values above 250 MHz are for informational purposes only.

PHYSICAL DATA

	CMR (NON-PLENUM)	CMP (PLENUM)
Nominal Cable Diameter (in)	0.205	0.200
Nominal Cable Weight (lbs/1000ft)	28	28
Minimum Bend Radius (in)	1.0	1.0
Maximum Pulling Force (lbs)	32	32
Temperature Rating (°C)		
Installation:	0 to +60	0 to +60
Operation:	-20 to +75	-20 to +75

ELECTRICAL CHARACTERISTICS

DC Resistance (max) Ohms/100m (328ft) @ 20°C	9.38
DC Resistance Unbalance (max) Individual Pair %	4.0
Delay Skew (max) ns/100m	45
Nom. Velocity of Propagation % Speed of Light	CMR: 70 CMP: 68
Characteristic Impedance	Ohms
Frequency (f): 1-250 MHz	100 ± 15
Input Impedance	Ohms
Frequency (f): 1-100 MHz	100 ± 15
Frequency (f): 100-250 MHz	100 ± 22

Data subject to change.



Designed to Meet
NFPA 262 and CSA FT6
Steiner Tunnel Fire Tests
for Plenum Applications
Underwriters Laboratories Inc.



Product Construction:

Conductors:

- 23 AWG solid bare annealed copper

Separator

- Tape

Insulation

- Non-Plenum: Polyolefin
- Plenum: Fluoropolymer

Rip Cord

- Applied longitudinally under jacket

Jacket

- Non-Plenum: flame-retardant PVC
- Plenum: low-smoke, flame-retardant PVC
- TRU-Mark® print legend contains footage markings from 1000' to 0'

Applications:

- IEEE 802.3: 1000 BASE-T (Gigabit Ethernet), 100 BASE-TX, 10 BASE-T
- ANSI/TIA/EIA 854: 1000 BASE-TX
- 155 Mp/s, 1.2 Gb/s ATM
- ANSI X3.263: 100 Mb/s
- IEEE 802.3af DTE Power (PoE)
- Digital video

Compliances:

- ANSI/TIA/EIA 568 B.2-1 (Category 6)
- ANSI/TIA/EIA 862 (Building Automation)
- ISO/IEC 11801 Ed. 2.0 (Class E)
- ICEA S-102-700 (Category 6)
- UL & c(UL) Type CMP (NFPA 262 and CSA FT6 Steiner Tunnel Fire Tests for Plenum Applications)
- UL 444
- RoHS Compliant Directive 2011/65/EU
- Third-party verified for guaranteed performance

Packaging:

- 1000' Pull-Pac® II
- 1000' Spool-Pac®

CATEGORY 6 CROSS-SECTION

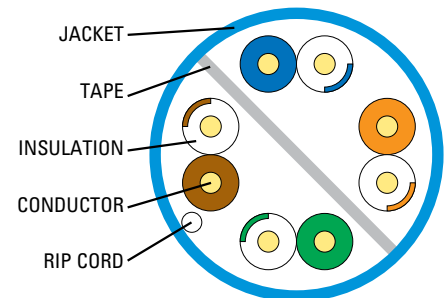

Category 5e Cable

Enhanced Transmission Throughput

Product Construction:

Conductors:

- 24 AWG solid bare annealed copper

Insulation

- Non-Plenum: Polyolefin
- Plenum: Fluoropolymer

Rip Cord

- Applied longitudinally under jacket

Jacket

- Non-Plenum: flame-retardant PVC
- Plenum: low-smoke, flame-retardant PVC
- TRU-Mark® print legend contains footage markings from 1000' to 0'

Applications:

- IEEE 802.3: 1000 BASE-T (Gigabit Ethernet), 100 BASE-TX, 10 BASE-T
- 52/155 Mp/s ATM
- ANSI X3.263: 100 Mb/s
- 4/16 Mp/s token ring

Compliances:

- ANSI/TIA/EIA 568 B.2 (Category 5e)
- ICEA S-90-661 (Category 5e)
- UL & c(UL) Type CMR (UL 1666) for Non-Plenum
- UL & c(UL) Type CMP (NFPA 262 and CSA FT6 Steiner Tunnel Fire Tests for Plenum Applications)
- UL 444
- RoHS Compliant Directive 2011/65/EU
- Third-party verified for guaranteed performance

Packaging:

- 1000' Pull-Pac® II
- 1000' Spool-Pac®

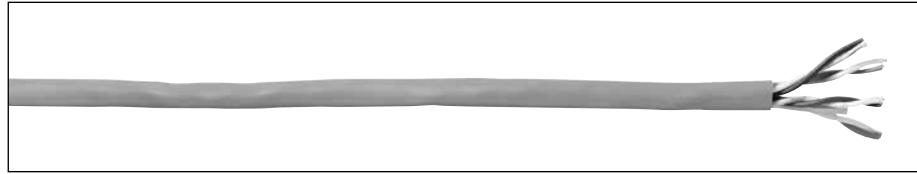

PART NUMBERS

JACKET COLOR	PULL-PAC® II		SPOOL-PAC®	
	CMR (NON-PLENUM)	CMP (PLENUM)	CMR (NON-PLENUM)	CMP (PLENUM)
Blue	CR5.30.07	CP5.30.07	CR5.A3.07	CP5.A3.07
White	CR5.30.02	CP5.30.02	CR5.A3.02	CP5.A3.02
Gray	CR5.30.10	CP5.30.10	CR5.A3.10	CP5.A3.10
Green	CR5.30.06	CP5.30.06	CR5.A3.06	CP5.A3.06
Yellow	CR5.30.05	CP5.30.05	CR5.A3.05	CP5.A3.05
Red	CR5.30.03	CP5.30.03	CR5.A3.03	CP5.A3.03

ELECTRICAL PERFORMANCE

FREQUENCY MHZ	PSACR (MIN)	ACR (MIN)	ATTENUATION (MAX)	PSNEXT (MIN)	NEXT (MIN)	PSELFEXT (MIN)	ELFEXT (MIN)	RETURN LOSS (MIN)
1	60.3	63.3	2.0	62.3	65.3	60.8	63.8	20.0
4	49.2	52.2	4.1	53.3	56.3	48.7	51.7	23.0
10	40.8	43.8	6.5	47.3	50.3	40.8	43.8	25.0
16	36.0	39.0	8.2	44.2	47.2	36.7	39.7	25.0
20	33.5	36.5	9.3	42.8	45.8	34.7	37.7	25.0
25	30.9	33.9	10.4	41.3	44.3	32.8	35.8	24.3
31.25	28.2	31.2	11.7	39.9	42.9	30.9	33.9	23.6
62.5	18.4	21.4	17.0	35.4	38.4	24.8	27.8	21.5
100	10.3	13.3	22.0	32.3	35.3	20.8	23.8	20.1
155	1.4	4.4	28.1	29.4	32.4	16.9	19.9	—
200	—	—	32.4	27.8	30.8	14.7	17.7	—
250	—	—	36.9	26.3	29.3	12.8	15.8	—
350	—	—	44.9	24.1	27.1	9.9	12.9	—

Notes: Values are expressed in dB per 100m (328 ft.) length. Values above 250 MHz are for informational purposes only.

PHYSICAL DATA

	CMR (NON-PLENUM)	CMP (PLENUM)
Nominal Cable Diameter (in)	0.200	0.180
Nominal Cable Weight (lbs/1000ft)	21	19
Minimum Bend Radius (in)	1.0	1.0
Maximum Pulling Force (lbs)	25	25
Temperature Rating (°C)		
Installation:	0 to +60	0 to +60
Operation:	-10 to +60	-10 to +60

CATEGORY 5e CROSS-SECTION

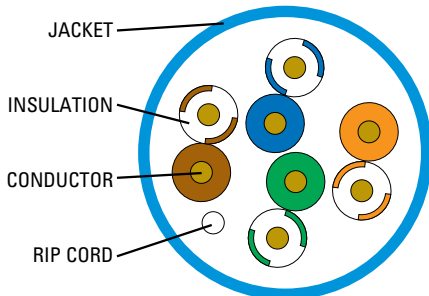

ELECTRICAL CHARACTERISTICS

DC Resistance (max) Ohms/100m (328ft) @ 20°C	8.9
DC Resistance Unbalance (max) Individual Pair %	3.0
Mutual Capacitance (nom) pF/ft @ 1 KHz	14
Delay Skew (max) ns/100m	45
Nom. Velocity of Propagation % Speed of Light	CMP: 72 CMR: 70
Characteristic Impedance Frequency (f):	Ohms 1-100 MHz 100 ± 15

Data subject to change.



Designed to Meet
NFPA 262 and CSA FT6
Steiner Tunnel Fire Tests
for Plenum Applications
Underwriters Laboratories Inc.



Coaxial Cable

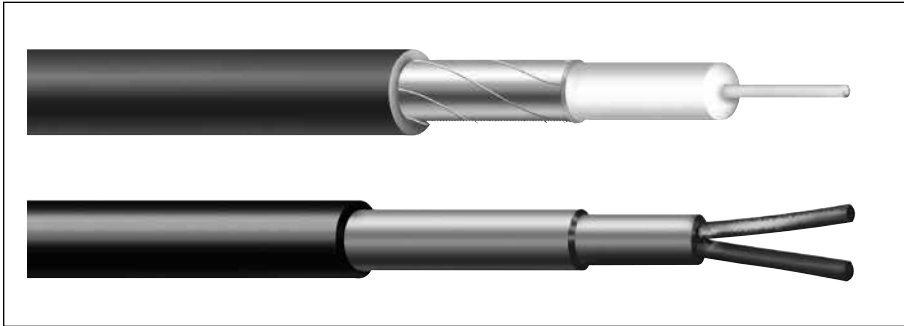

Index	Page
DBRF Coaxial	127-131
RG 6/U Type	132-137
RG 8/U Type	138-139
RG 11/U Type	140-143
RG 58/U Type	144
RG 59/U Type	145-151
RG 62/U Type	152
RG 174/U Type	153
RG 213/U Type	154
Twinaxial Cables	155

To meet the needs of today's sophisticated, high-speed, wide bandwidth electronics over long distances, with minimum signal loss or degradation, General Cable Carol® Brand offers a wide range of coaxial and twinaxial designs in both unbalanced arrays and precision-balanced pairs. This offers the system designer a wide choice of cost-effective products that reflect the most recent changes in the standards set by UL, CSA and/or the FCC.

Included in this section are recommended Carol Brand coaxial products for the CATV market. However, these constructions may differ in certain parts of the country.







Unlike other products in the electronic market, coaxial cable does not have one accepted standard construction.

General Cable recommends, in order to avoid installing an unacceptable coaxial cable for the CATV application in your area, the local CATV company should be consulted.

General Cable's Carol Brand product mix encompasses standard RG/U-type coaxial constructions in the more popular 50, 75 and 93 ohm designs and miniature coaxial products for smaller high-speed applications.







The twinaxial products meet or exceed the stringent demands of today's precision-balanced pair systems. The minimization of capacitance unbalance is a necessary requirement for long distance data transmission.

DBRF Coaxial

CATALOG NUMBER	COND. SIZE	INSULATION MATERIAL		SHIELD COVERAGE NOM. SHLD. DCR	NOMINAL O.D.		NOMINAL CAPACITANCE		VELOCITY OF PROPAGATION, %	NOMINAL IMPEDANCE, Ω	NOMINAL ATTENUATION												
		INCHES	mm		INCHES	mm	pF/ft	pF/m			MHz	dB/100'											
DBRF100 	.018" Solid Copper Covered Steel	Polyethylene		100% Dual Foil Bonded + 90% Tin Copper Braid	Flame-Retardant PVC		30.80	101.10	66	50	30	3.9											
		0.060	1.52		0.110	2.79					50	5.1	150	8.9	220	10.9	450	15.8	900	22.8	1500	30.1	1800
DBRF100HF 	.018" Solid Copper Covered Steel	Polyethylene		100% Dual Foil Bonded + 90% Tin Copper Braid	Flame-Retardant LSZH		30.80	101.10	66	50	30	3.9											
		0.060	1.52		0.110	2.79					50	5.1	150	8.9	220	10.9	450	15.8	900	22.8	1500	30.1	1800
DBRF100R NEC Type CMR and CSA CMG c(ETL)us 	.018" Solid Copper Covered Steel	Polyethylene		100% Dual Foil Bonded + 90% Tin Copper Braid	Flame-Retardant PVC		30.80	101.10	66	50	30	3.9											
		0.060	1.52		0.110	2.79					50	5.1	150	8.9	220	10.9	450	15.8	900	22.8	1500	30.1	1800
DBRF195 	.037" Solid Bare Copper	Foam Polyethylene		100% Dual Foil Bonded + 90% Tin Copper Braid	Polyethylene		25.40	83.30	78	50	30	1.8											
		0.110	2.79		0.195	4.95					50	2.34	150	4.13	220	5.05	450	7.39	900	10.79	1500	14.38	1800
DBRF195FL Flooded Outdoor 	.037" Solid Bare Copper	Foam Polyethylene		100% Dual Foil Bonded + 90% Tin Copper Braid	Polyethylene		25.40	83.30	78	50	30	1.8											
		0.110	2.79		0.195	4.95					50	2.34	150	4.13	220	5.05	450	7.39	900	10.79	1500	14.38	1800
DBRF195HF NEC Type CMR-LS and CSA CMG c(ETL)us 	.037" Solid Bare Copper	Foam Polyethylene		100% Dual Foil Bonded + 90% Tin Copper Braid	Flame-Retardant LSZH		25.40	83.30	78	50	30	1.8											
		0.110	2.79		0.195	4.95					50	2.34	150	4.13	220	5.05	450	7.39	900	10.79	1500	14.38	1800

Data subject to change.







DBRF Coaxial

CATALOG NUMBER	COND. SIZE	INSULATION MATERIAL		SHIELD COVERAGE NOM. SHLD. DCR	NOMINAL O.D.		NOMINAL CAPACITANCE		VELOCITY OF PROPAGATION, %	NOMINAL IMPEDANCE, Ω	NOMINAL ATTENUATION												
		INCHES	mm		INCHES	mm	pF/ft	pF/m			MHz	dB/100'											
DBRFR195R NEC Type CMR and CSA CMG c(ETL)us 	.037" Solid Bare Copper	Foam Polyethylene		100% Dual Foil Bonded + 90% Tin Copper Braid	Flame-Retardant PVC		25.40	83.30	78	50	30	1.8											
		0.110	2.79		0.195	4.95					50	2.34	150	4.13	220	5.05	450	7.39	900	10.79	1500	14.38	1800
DBRF195P NEC Type CMP and CSA c(ETL)us 	.037" Solid Bare Copper	Foam FEP		100% Dual Foil Bonded + 90% Tin Copper Braid	Flame-Retardant PVC		25.00	82.00	80	50	30	2.0											
		0.110	2.79		0.175	4.45					50	2.5	150	4.4	220	5.3	450	7.8	900	10.90	1500	14.89	1800
DBRF200 	.044" Solid Bare Copper	Foam Polyethylene		100% Dual Foil Bonded + 90% Tin Copper Braid	Polyethylene		24.50	80.40	83	50	30	1.8											
		0.116	2.95		0.195	4.95					50	2.3	150	3.9	220	4.8	450	6.9	900	9.9	1500	12.9	1800
DBRF200FL Water Block 	.044" Solid Bare Copper	Foam Polyethylene		100% Dual Foil Bonded + 90% Tin Copper Braid	Polyethylene		24.50	80.40	83	50	30	1.8											
		0.116	2.95		0.195	4.95					50	2.3	150	3.9	220	4.8	450	6.9	900	9.9	1500	12.9	1800
DBRF200HF NEC CMR-LS, c(ETL)us 	.044" Solid Bare Copper	Foam Polyethylene		100% Dual Foil Bonded + 90% Tin Copper Braid	Flame-Retardant LSZH		24.50	80.40	83	50	30	1.8											
		0.116	2.95		0.195	4.95					50	2.3	150	3.9	220	4.8	450	6.9	900	9.9	1500	12.9	1800
DBRF200R NEC Type CMR and CSA CMG c(ETL)us 	.044" Solid Bare Copper	Foam Polyethylene		100% Dual Foil Bonded + 90% Tin Copper Braid	Flame-Retardant PVC		24.50	80.40	83	50	30	1.8											
		0.116	2.95		0.195	4.95					50	2.3	150	3.9	220	4.8	450	6.9	900	9.9	1500	12.9	1800

Data subject to change.









DBRF Coaxial

CATALOG NUMBER	COND. SIZE	INSULATION MATERIAL		SHIELD COVERAGE NOM. SHLD. DCR	NOMINAL O.D.		NOMINAL CAPACITANCE		VELOCITY OF PROPAGATION, %	NOMINAL IMPEDANCE, Ω	NOMINAL ATTENUATION												
		INCHES	mm		INCHES	mm	pF/ft	pF/m			MHz	dB/100'											
DBRF200P NEC CMP and CSA c(ETL)us 	.040" Solid Bare Copper	Foam FEP		100% Dual Foil Bonded + 90% Tin Copper Braid	Low Smoke Plenum PVC		25.00	82.00	80	50	30	1.8											
		0.118	2.99		0.180	4.57					50	2.3	150	4.1	220	4.9	450	7.1	900	10.0	1500	14.47	1800
DBRF240 	.056" Solid Bare Copper	Foam Polyethylene		100% Dual Foil Bonded + 90% Tin Copper Braid	Polyethylene		24.30	79.72	84	50	30	1.3											
		0.150	3.81		0.240	6.10					50	1.7	150	2.9	220	3.7	450	5.3	900	7.6	1500	9.9	1800
DBRF240FL Water Blocked 	.056" Solid Bare Copper	Foam Polyethylene		100% Dual Foil Bonded + 90% Tin Copper Braid	Polyethylene		24.30	79.72	84	50	30	1.3											
		0.150	3.81		0.240	6.10					50	1.7	150	2.9	220	3.7	450	5.3	900	7.6	1500	9.9	1800
DBRF240HF NEC CMR-LS and CSA CMG c(ETL)us 	.056" Solid Bare Copper	Foam Polyethylene		100% Dual Foil Bonded + 90% Tin Copper Braid	Flame-Retardant LSZH		24.30	79.72	84	50	30	1.3											
		0.150	3.81		0.240	6.10					50	1.7	150	2.9	220	3.7	450	5.3	900	7.6	1500	9.9	1800
DBRF240R 	.056" Solid Bare Copper	Foam Polyethylene		100% Dual Foil Bonded + 90% Tin Copper Braid	Flame-Retardant PVC		24.30	79.72	84	50	30	1.3											
		0.150	3.81		0.240	6.10					50	1.7	150	2.9	220	3.7	450	5.3	900	7.6	1500	9.9	1800
DBRF240P NEC CMP and CSA c(ETL)us 	.051" Solid Bare Copper	Foam FEP		100% Dual Foil Bonded + 90% Tin Copper Braid	LS Plenum PVC		25.00	82.00	80	50	30	1.4											
		0.150	3.81		0.214	5.44					50	1.8	150	3.1	220	3.7	450	5.4	900	7.6	1500	11.72	1800

Data subject to change.





DBRF Coaxial

CATALOG NUMBER	COND. SIZE	INSULATION MATERIAL		SHIELD COVERAGE NOM. SHLD. DCR	NOMINAL O.D.		NOMINAL CAPACITANCE		VELOCITY OF PROPAGATION, %	NOMINAL IMPEDANCE, Ω	NOMINAL ATTENUATION												
		INCHES	mm		INCHES	mm	pF/ft	pF/m			MHz	dB/100'											
DBRF300 	.070" Solid Bare Copper	Foam Polyethylene		100% Dual Foil Bonded + 90% Tin Copper Braid	Polyethylene		24.00	78.80	85	50	30	1.1											
		0.190	4.83		0.300	7.62					50	1.4	150	2.4	220	2.9	450	4.2	900	9.1	1500	7.9	1800
DBRF300FL Water Blocked 	.070" Solid Bare Copper	Foam Polyethylene		100% Dual Foil Bonded + 90% Tin Copper Braid	Polyethylene		24.00	78.80	85	50	30	1.1											
		0.190	4.83		0.300	7.62					50	1.4	150	2.4	220	2.9	450	4.2	900	9.1	1500	7.9	1800
DBRF300HF NEC Type CMR-LS and CSA CMG c(ETL)us 	.070" Solid Bare Copper	Foam Polyethylene		100% Dual Foil Bonded + 90% Tin Copper Braid	Flame-Retardant LSZH		24.00	78.80	85	50	30	1.1											
		0.190	4.83		0.300	7.62					50	1.4	150	2.4	220	2.9	450	4.2	900	9.1	1500	7.9	1800
DBRF300R NEC Type CMR and CSA CMG c(ETL)us 	.070" Solid Bare Copper	Foam Polyethylene		100% Dual Foil Bonded + 90% Tin Copper Braid	Flame-Retardant PVC		24.00	78.80	85	50	30	1.1											
		0.190	4.83		0.300	7.62					50	1.4	150	2.4	220	2.9	450	4.2	900	9.1	1500	7.9	1800
DBRF300P NEC CMP and CSA c(ETL)us 	.064" Solid Bare Copper	Foam FEP		100% Dual Foil Bonded + 90% Tin Copper Braid	LS Plenum PVC		25.00	82.00	85	50	30	1.1											
		0.190	4.83		0.260	6.60					50	1.4	150	2.5	220	3.0	450	4.3	900	7.16	1500	10.0	1800
DBRF400 	.108" Bare Copper-Clad Aluminum	Foam Polyethylene		100% Dual Foil Bonded + 90% Tin Copper Braid	Polyethylene		23.50	77.10	85	50	30	0.7											
		0.285	7.24		0.405	10.29					50	0.9	150	1.5	220	1.9	450	2.7	900	3.9	1500	5.2	1800

Data subject to change.



DBRF Coaxial

CATALOG NUMBER	COND. SIZE	INSULATION MATERIAL		SHIELD COVERAGE NOM. SHLD. DCR	NOMINAL O.D.		NOMINAL CAPACITANCE		VELOCITY OF PROPAGATION, %	NOMINAL IMPEDANCE, Ω	NOMINAL ATTENUATION	
		INCHES	mm		INCHES	mm	pF/ft	pF/m			MHz	dB/100'
DBRF400FL Flooded Outdoor 	.108" Bare Copper- Clad Aluminum	Foam Polyethylene		100% Dual Foil Bonded + 90% Tin Copper Braid	Polyethylene		23.50	77.10	85	50	30	0.7
		0.285	7.24		0.405	10.29					50	0.9
DBRF400HF NEC Type CMR-LS and CSA CMG c(ETL)us 	.108" Bare Copper- Clad Aluminum	Foam Polyethylene		100% Dual Foil Bonded + 90% Tin Copper Braid	Flame-Retardant LSZH		23.50	77.10	85	50	30	0.7
		0.285	7.24		0.405	10.29					50	0.9
DBRF400R NEC Type CMR and CSA CMG c(ETL)us 	.108" Bare Copper- Clad Aluminum	Foam Polyethylene		100% Dual Foil Bonded + 90% Tin Copper Braid	Flame-Retardant PVC		23.50	77.10	85	50	30	0.7
		0.285	7.24		0.405	10.29					50	0.9
DBRF400P NEC Type CMP and CSA c(ETL)us/150C 	.108" Bare Copper- Clad Aluminum	Foam FEP		100% Dual Foil Bonded + 90% Tin Copper Braid	PVDF - Copolymer		24.50	80.36	85	50	30	0.8
		0.285	7.24		0.350	8.89					50	1.01

Data subject to change.

RG 6/U Type

Product Construction:

Conductors:

- Copper per ASTM B3
- Copper-clad steel per ASTM B869

Insulation/Core:

- Foam polyethylene (PE)

Shield:

- Bare copper or aluminum braid
- Flexfoil® shield

Jacket:





- Premium PVC compound

Packaging:

- Please contact Customer Service for packaging and color options

Applications:

- Suitable for RF signal transmission
- MATV
- CATV
- CCTV†
- HDTV
- Digital video
- Drop cable
- FM broadcast

CATALOG NUMBER	AWG SIZE NOM. DCR	INSULATION P		SHIELD COVERAGE NOM SHLD DCR	NOMINAL O.D.		NOMINAL CAPACITANCE		VELOCITY OF PROPAGATION, %	NOMINAL IMPEDANCE, Ω	NOMINAL ATTENUATION	
		INCHES	mm		INCHES	mm	pF/ft	pF/m			MHz	dB/100'
C5760 RG 6/U Type 	18 Ga. Solid Copper-Clad Steel 28.9 Ω/Mft.	Foam PE		100% Flexfoil® 30 Ga. CCS Spiral Served Shield 30.0 Ω/Mft.	PVC		16.20	53.15	82	75	1	0.26
		0.180	4.57		0.240	6.10					10	0.81
C5761† RG 6/U Type UL CL2, CM c(UL) CM, (UL) or (ETL) 	18 Ga. Solid Bare Copper 6.5 Ω/Mft.	Foam PE		100% Flexfoil® +95% Bare Copper Braid 2.6 Ω/Mft.	PVC		16.20	53.15	83	75	1	0.26
		0.180	4.57		0.275	6.98					10	0.81
C5775 RG 6/U Type UL CL2, CATV, CM c(UL) CM, (UL) or (ETL) 	18 Ga. Solid Copper-Clad Steel 28.9 Ω/Mft.	Foam PE		100% Flexfoil® Bonded +60% Aluminum Braid 9.0 Ω/Mft.	PVC		16.20	53.15	83	75	1	0.26
		0.180	4.57		0.275	6.98					10	0.81
C5886 RG 6/U Type Riser UL CL2R, CATVR, CMR c(UL) CMR, c(UL) CM (UL) or (ETL) 	18 Ga. Solid Copper-Clad Steel 28.9 Ω/Mft.	Foam PE		100% Flexfoil® Bonded +60% Aluminum Braid 9.0 Ω/Mft.	PVC		16.20	53.15	83	75	1	0.26
		0.180	4.57		0.275	6.98					10	0.81
C5776 RG 6/U Type UL CL2, CATV, CM c(UL) CM, (UL) or (ETL) 	18 Ga. Solid Copper-Clad Steel 28.9 Ω/Mft.	Foam PE		100% Flexfoil® Bonded +95% Aluminum Braid 10.5 Ω/Mft.	PVC		16.20	53.15	83	75	1	0.26
		0.180	4.57		0.275	6.98					10	0.81

Data subject to change.



RG 6/U Type

Product Construction:

Conductors:

- Copper-clad steel per ASTM B869

Insulation/Core:

- Foam polyethylene (PE)

Shield:

- Tinned, bare copper or aluminum braid
- Flexfoi® shield

Jacket:





- Premium PVC compound or PE compound

Packaging:

- Please contact Customer Service for packaging and color options

Applications:

- CATV
- Direct burial

CATALOG NUMBER	AWG SIZE NOM. DCR	INSULATION MATERIAL		SHIELD COVERAGE NOM SHLD DCR	NOMINAL O.D.		NOMINAL CAPACITANCE		VELOCITY OF PROPAGATION, %	NOMINAL IMPEDANCE, Ω	NOMINAL ATTENUATION	
		INCHES	mm		INCHES	mm	pF/ft	pF/m			MHz	dB/100'
C5785 RG 6/U Type Quad-Shield UL CL2, CATV, CM c(UL) CM 	18 Ga. Solid Copper-Clad Steel 28.9 Ω/Mft.	Foam PE		(2) 100% Flexfoi® 1st Bonded (1) 60% (2) 40% Aluminum Braids 3.7 Ω/Mft.	PVC		16.20	53.15	83	75	1	0.26
		0.180	4.57		0.292	7.42					10	0.81
C5889 RG 6/U Type Riser Quad-Shield UL CL2R, CATVR, CMR c(UL) CM 	18 Ga. Solid Copper-Clad Steel 28.9 Ω/Mft.	Foam PE		(2) 100% Flexfoi® 1st Bonded (1) 60% (2) 40% Aluminum Braids 3.7 Ω/Mft.	PVC		16.20	53.15	83	75	1	0.26
		0.180	4.57		0.292	7.42					10	0.81
C5777 RG 6/U Type UL CL2, CATV, CM c(UL) CM 	18 Ga. Solid Copper-Clad Steel 28.9 Ω/Mft.	Foam PE		100% Flexfoi® Bonded +61% Tinned Copper Braid 6.5 Ω/Mft.	PVC		16.20	53.15	83	75	1	0.26
		0.180	4.57		0.275	6.98					10	0.81
C5804 RG 6/U Type MoistureGuard™ Direct Burial, Flooded 	18 Ga. Solid Copper-Clad Steel 28.9 Ω/Mft.	Foam PE		100% Flexfoi® Bonded +60% Aluminum Braid w/water block 9.0 Ω/Mft.	Black PE		16.20	53.15	83	75	1	0.26
		0.180	4.57		0.275	6.98					10	0.81

Data subject to change.

RG 6/U Type

Product Construction:

Conductors:

- Copper per ASTM B3
- Copper-clad steel per ASTM B869

Insulation/Core:

- Foam polyethylene (PE)

Shield:

- Tinned copper or aluminum braid
- Flexfoil® shield

Jacket:

- Premium PVC compound

Packaging:

- Please contact Customer Service for packaging and color options

Applications:

- LAN cable
- CATV
- Direct broadcast satellite

CATALOG NUMBER	AWG SIZE NOM. DCR	INSULATION MATERIAL		SHIELD COVERAGE NOM SHLD DCR	NOMINAL O.D.		NOMINAL CAPACITANCE		VELOCITY OF PROPAGATION, %	NOMINAL IMPEDANCE, Ω	NOMINAL ATTENUATION	
		INCHES	mm		INCHES	mm	pF/ft	pF/m			MHz	dB/100'
C5822 RG 6/U Dual-Type DBS UL CL2, CATV, CM c(UL) CM 	18 Ga. Solid Copper-Clad Steel 28.9 Ω/Mft.	Foam PE		100% Flexfoil® Bonded +60% Aluminum Braid 9.0 Ω/Mft.	PVC		16.20	53.15	83	75	1	0.26
		0.180	4.57		10	0.81						
					50	1.46						
					100	2.05						
					200	2.83						
					500	4.53						
					1000	6.59						
					1450	8.10						
					1800	8.80						
					2200	10.10						
3000	11.79											

Data subject to change.



RG 6/U Type

Product Construction:

Conductors:

- Copper per ASTM B3 or copper-clad steel per ASTM B869
- Twisted pair color code: black and red

Insulation/Core:

- Foam polyethylene (PE)
- Foam fluoropolymer (FEP)

Shield:

- Tinned copper or aluminum braid
- Flexfoil® shield

Jacket:







- Premium-grade PVC compound
- Flexguard® PVC compound

Packaging:

- Please contact Customer Service for packaging and color options

Applications:

- Suitable for RF signal transmission
- CATV
- CCTV†
- DBS
- Drop cable
- FM broadcast
- HDTV
- Digital video

CATALOG NUMBER	AWG SIZE NOM. DCR	INSULATION MATERIAL		SHIELD COVERAGE NOM SHLD DCR	NOMINAL O.D.		NOMINAL CAPACITANCE		VELOCITY OF PROPAGATION, %	NOMINAL IMPEDANCE, Ω	NOMINAL ATTENUATION	
		INCHES	mm		INCHES	mm	pF/ft	pF/m			MHz	dB/100'
C5778 RG 6/U Type UL CL2, CATV, CM c(UL) CM 	18 Ga. Solid Bare Copper 6.5 Ω/Mft.	Foam PE		100% Flexfoil® Bonded +61% Tinned Copper Braid 6.5 Ω/Mft.	PVC		16.20	53.15	83	75	1	0.26
		0.180	4.57		0.275	6.98					10	0.81
C3523 RG 6/U Type Plenum UL CL2P, CMP c(UL) CMP 	18 Ga. Solid Bare Copper 6.5 Ω/Mft.	Fluoropolymer		100% Flexfoil® +80% Tinned Copper Braid 2.3 Ω/Mft.	Flexguard® PVC		16.40	52.50	83	75	1	0.30
		0.170	4.32		0.232	5.89					10	0.66
C3521 RG 6/U Type Plenum UL CL2P, CMP c(UL) CMP 	18 Ga. Solid Bare Copper 6.5 Ω/Mft.	Fluoropolymer		Flexfoil® Bonded +95% Tinned Copper Braid 2.3 Ω/Mft.	Flexguard® PVC		16.00	52.50	83	75	1	0.30
		0.170	4.32		0.232	5.89					10	0.66
C3524 RG 6/U Type Plenum UL CL2P, CMP c(UL) CMP 	18 Ga. Solid Copper-Clad Steel 28.6 Ω/Mft.	Fluoropolymer		Flexfoil® Bonded +80% Aluminum Braid 9.0 Ω/Mft.	Flexguard® PVC		16.00	52.50	83	75	1	0.30
		0.170	4.32		0.232	5.89					10	0.66
C3525 RG 6/U Type Quad Shield Plenum UL CL2P, CMP c(UL) CMP 	18 Ga. Solid Copper-Clad Steel 28.6 Ω/Mft.	Fluoropolymer		(2) 100% Flexfoil® (1) 60% (2) 40% Aluminum Braids 5.3 Ω/Mft.	Flexguard® PVC		16.00	52.50	83	75	1	0.30
		0.170	4.32		0.264	6.70					10	0.66
C8029† RG 6/U Type +18 AWG Unshielded Pair UL CL2, CM c(UL) CM 	18 Ga. Solid Bare Copper Coax 18 AWG (7/26) Unshielded Pair	Foam PE		100% Flexfoil® 95% Bare Copper Braid 1.9 Ω/Mft.	PVC		16.20	53.15	83	75	1	0.20
		0.180	4.57		0.270	6.86					10	0.72
		Premium PVC		0.493	12.52	50					1.48	
C8031† RG 6/U Type +18 AWG Unshielded Pair UL CMP c(UL) CMP 	18 AWG Solid Bare Copper Coax 18 AWG (7/26) Unshielded Pair	Fluoropolymer		95% Bare Copper Braid 3.5 Ω/Mft.	Flexguard® PVC		16.30	53.48	83	75	1	0.30
		0.170	0.432		0.232	5.89					10	0.66
		Halar		0.416	10.57	50					1.50	
		0.006	0.15	Unshielded Pair							200	3.10
											500	5.00
											1000	7.30

Data subject to change.



RG 6/U Type

Product Construction:

Conductors:

- Copper per ASTM B3

Insulation/Core:

- Foam polyethylene (PE)

Shield:

- Tinned copper braid
- Flexfoil® shield

Jacket:





- Premium-grade PVC compound
- Flexguard® PVC compound or PVDF

Packaging:

- Please contact Customer Service for packaging and color options

Applications:

- Broadcast grade headend
- Serial Digital Interface (SDI)
- CATV
- DBS
- Drop cable
- HDTV
- CCTV†
- Digital video

CATALOG NUMBER	AWG SIZE NOM. DCR	INSULATION MATERIAL		SHIELD COVERAGE NOM SHLD DCR	NOMINAL O.D.		NOMINAL CAPACITANCE		VELOCITY OF PROPAGATION, %	NOMINAL IMPEDANCE, Ω	NOMINAL ATTENUATION	
		INCHES	mm		INCHES	mm	pF/ft	pF/m			MHz	dB/100'
395011 UL CMR c(UL) CMG 	18 Ga. Solid Bare Copper 6.5 Ω/Mft.	Foam PE		Dual Foil + 95% Tinned Copper Braid Shield 2.8 Ω/Mft.	Flame-Retardant PVC		16.20	53.10	83	75	1	0.24
		0.180	4.57		3.6	0.45						
0.275	6.91			135	2.10							
		0.232	5.89	270	2.97							
0.232	5.89			540	4.25							
		0.232	5.89	1500	7.33							
0.232	5.89			2250	9.14							
		0.232	5.89	3000	10.67							
495035† UL CMP c(UL) CMP 75°C 	18 Ga. Solid Bare Copper 6.7 Ω/Mft.			Fluoropolymer		95% Bare Copper Braid 2.0 Ω/Mft.	Flexguard® PVC		16.20	52.50	83	75
		0.170	4.32	10	0.65							
0.170	4.32			50	1.46							
		0.170	4.32	100	2.04							
0.170	4.32			200	2.98							
		0.170	4.32	540	5.18							
0.170	4.32			1000	7.05							
		0.170	4.32	1500	8.64							
0.170	4.32			2250	10.58							
		0.170	4.32	3000	12.21							
495036† UL CMP c(UL) CMP 105°C 	18 Ga. Solid Bare Copper 6.7 Ω/Mft.			Fluoropolymer		95% Bare Copper Braid 2.0 Ω/Mft.	PVDF		16.10	53.00	83	75
		0.170	4.32	10	0.65							
0.170	4.32			50	1.46							
		0.170	4.32	100	2.04							
0.170	4.32			200	2.98							
		0.170	4.32	540	5.18							
0.170	4.32			1000	7.05							
		0.170	4.32	1500	8.64							
0.170	4.32			2250	10.58							
		0.170	4.32	3000	12.21							
495025 UL CMP c(UL) CMP 	18 Ga. Solid Bare Copper 6.5 Ω/Mft.			Fluoropolymer		Dual Foil + 95% Tinned Copper Braid Shield 2.8 Ω/Mft.	Flexguard® PVC		16.10	53.00	83	75
		0.170	4.32	3.6	0.45							
0.170	4.32			135	2.40							
		0.170	4.32	270	2.75							
0.170	4.32			540	4.00							
		0.170	4.32	1500	6.36							
0.170	4.32			2250	11.60							
		0.170	4.32	3000	13.70							
C3531 UL CMP, CL2P, 75°C 	18 Ga. Solid Bare Copper 28.9 Ω/Mft.			Fluoropolymer		Dual Foil + 77% Aluminum Braid Shield 5.0 Ω/Mft.	Flexguard® PVC		15.5	51.02	83	75
		0.170	4.32	10	0.66							
0.170	4.32			50	1.48							
		0.170	4.32	100	2.10							
0.170	4.32			200	3.10							
		0.170	4.32	360	4.11							
0.170	4.32			500	5.00							
		0.170	4.32	700	6.40							
0.170	4.32			1000	7.35							
		0.170	4.32	2300	12.20							
0.170	4.32			3000	13.28							

Data subject to change.



RG 6/U Multi-Channel Digital/Precision, Riser Rated

75 Ohm High-End Coaxial Cables for Exacting Video, Analog, Digital & Monitor Applications

Product Construction:

Conductors:

- Copper per ASTM B3

Insulation/Core:

- Foam polyethylene (PE)

Shield:

- Dual Flexfoil® shield
- Tinned copper braid

Jacket:



- Outer jacket: black matte finish thermoplastic elastomer (TPE)
- Inner jacket: flame-retardant PVC; see color codes below

Packaging:

- Please contact Customer Service for packaging and color options

Applications:

- Analog/Digital Video Broadcast-Grade Monitor
- HDTV

CATALOG NUMBER	AWG SIZE NOM. DCR	INSULATION MATERIAL		SHIELD COVERAGE NOM SHLD DCR	NOMINAL O.D.		NOMINAL CAPACITANCE		VELOCITY OF PROPAGATION, %	NOMINAL IMPEDANCE, Ω	NOMINAL ATTENUATION	
		INCHES	mm		INCHES	mm	pF/ft	pF/m			MHz	dB/100'
395011-3 UL CMR c(UL) CMG 	18 Ga. 3/Cond. Solid Bare Copper 6.5 Ω/Mft.	Foam PE		Bi-Metal Foil + 95% Tinned Copper Braid Shield (2.8 Ohm)	Inner: Flame-Retardant PVC Outer: TPE matte		16.20	53.20	83	75	1	0.24
		0.180	4.57		0.685	17.40						
395011-4 UL CMR c(UL) CMG 	18 Ga. 4/Cond. Solid Bare Copper 6.5 Ω/Mft.	Foam PE		Bi-Metal Foil + 95% Tinned Copper Braid Shield (2.8 Ohm)	Inner: Flame-Retardant PVC Outer: TPE matte		16.20	53.20	83	75	1	0.24
		0.180	4.57		0.755	19.18						
395011-5 UL CMR c(UL) CMG 	18 Ga. 5/Cond. Solid Bare Copper 6.5 Ω/Mft.	Foam PE		Bi-Metal Foil + 95% Tinned Copper Braid Shield (2.8 Ohm)	Inner: Flame-Retardant PVC Outer: TPE matte		16.20	53.20	83	75	1	0.24
		0.180	4.57		0.860	21.85						

Data subject to change.

Inner Jacket Color Code Chart

Ordering Suffix	COLOR
1	Red
2	Green
3	Blue
4	White
5	Yellow

Note: 395011-3 will have the first three colors,
395011-4 will have the first four colors
and 395011-5 will have all five colors.

RG 8/U Type

Product Construction:

Conductors:

- Copper per ASTM B3

Insulation/Core:

- Solid and cellular polyethylene

Shield:

- Tinned or bare copper braid
- Flexfoil® shield

Jacket:





- Premium PVC compound

Packaging:

- Please contact Customer Service for packaging and color options

Applications:

- Suitable for RF signal transmission
- Broadcast

CATALOG NUMBER	AWG SIZE NOM. DCR	INSULATION MATERIAL		SHIELD COVERAGE NOM SHLD DCR	NOMINAL O.D.		NOMINAL CAPACITANCE		VELOCITY OF PROPAGATION, %	NOMINAL IMPEDANCE, Ω	NOMINAL ATTENUATION	
		INCHES	mm		INCHES	mm	pF/ft	pF/m			MHz	dB/100'
C1108A RG 8/U Mini Type UL CL2, CM CSA CMG 1354 	16 Ga. (19/28) Bare Copper 4.2 Ω/Mft.	Foam PE		95% Bare Copper Braid 3.3 Ω/Mft.	PVC		25.30 83.01	80 50	50	1 10 50 100 200 500 1000	0.26 0.98 2.30 3.30 4.90 8.50 14.30	
		0.155	3.94		0.242	6.15						
C1154 RG 8/U Type JAN-C-17A TYPE 1354 	13 Ga. (7/21) Bare Copper 1.9 Ω/Mft.	Solid PE		95% Bare Copper Braid 1.2 Ω/Mft.	PVC		29.50 96.79	66 52	52	1 10 50 100 200 500 1000	0.16 0.56 1.30 1.90 2.80 4.70 7.40	
		0.285	7.24		0.405	10.29						
C1198 RG 8/U Type 1354 	11 Ga. (19/24) Bare Copper 1.9 Ω/Mft.	Foam PE		95% Bare Copper Braid 1.1 Ω/Mft.	PVC		26.00 85.31	78 50	50	1 10 50 100 200 500 1000	0.17 0.57 1.20 1.80 2.70 4.70 7.10	
		0.285	7.24		0.405	10.29						
C1180 RG 8/U Type Air Core 	9½ Ga. Solid Bare Copper 0.90 Ω/Mft.	Semi-Solid PE		100% Flexfoil® Bonded +88% Tinned Copper Braid 1.8 Ω/Mft.	PVC		24.60 80.71	84 50	50	1 10 50 100 200 500 1000	0.13 0.40 0.90 1.30 1.80 3.00 4.50	
		0.285	7.24		0.405	10.29						

Data subject to change.



RG 8/U Type Thicknet/Trunk Cable

50 Ohm IEEE 802.3 and ISO/IEC 8802.3 10 Base 5 LAN and Computer Cables

Product Construction:

Conductors:

- Copper per ASTM B3

Insulation/Core:

- Foam polyethylene (PE)
- Foam fluoropolymer (FEP)

Shield:

- Tinned copper braid
- Flexfoil® shield

Jacket:



- Premium PVC compound
- Premium PVDF compound

Packaging:

- Please contact Customer Service for packaging and color options

Applications:

- LAN & data transmission computer cables
- Thicknet/trunk cable – IEEE 802.3 and ISO/IEC 8802.3 10 base 5 LAN computer cables

CATALOG NUMBER	AWG SIZE NOM. DCR	INSULATION MATERIAL		SHIELD COVERAGE NOM SHLD DCR	NOMINAL O.D.		NOMINAL CAPACITANCE		VELOCITY OF PROPAGATION, %	NOMINAL IMPEDANCE, Ω	NOMINAL ATTENUATION	
		INCHES	mm		INCHES	mm	pF/ft	pF/m			MHz	dB/100'
397001 RG 8/U Type THICKNET DEC 17-000451-00 UL CM c(UL) 	12 Ga. Solid Bare Copper 1.42 Ω/Mft.	Foam PE		Quad Shield Dual Flexfoil® 94% Tinned Copper Braid + Dual Flexfoil® 94% Tinned Copper Braid 1.52 Ω/Mft.	Yellow Flame-Retardant PVC		26.00	85.30	78	50	1	0.17
		0.245	6.22		0.405	10.29					5	0.37
497001 RG 8/U Type THICKNET DEC 17-000324-00 UL CMP c(UL) 	12 Ga. Solid Bare Copper 1.42 Ω/Mft.	Fluoropolymer		Quad Shield Dual Flexfoil® 94% Tinned Copper Braid + Dual Flexfoil® 94% Tinned Copper Braid 1.52 Ω/Mft.	Orange PVDF		25.00	82.00	84	50	1	0.16
		0.245	6.22		0.375	9.53					5	0.35
											10	0.53
											50	1.20
											100	1.73
											200	2.50
											400	3.64
											700	4.97
											900	5.74
											1000	6.10

Data subject to change.

RG 11/U Type

Product Construction:

Conductors:

- Copper per ASTM B3
- Copper-clad steel per ASTM B869

Insulation/Core:

- Solid and foam polyethylene (PE)

Shield:

- Tinned, bare copper or aluminum braid
- Flexfoil® shield

Jacket:





- Premium PVC compound or PE compound

Packaging:

- Please contact Customer Service for packaging and color options

Applications:

- Suitable for RF signal transmission
- Broadcast digital video
- MATV
- CATV
- Drop cable
- Outdoor use

CATALOG NUMBER	AWG SIZE NOM. DCR	INSULATION MATERIAL		SHIELD COVERAGE NOM SHLD DCR	NOMINAL O.D.		NOMINAL CAPACITANCE		VELOCITY OF PROPAGATION, %	NOMINAL IMPEDANCE, Ω	NOMINAL ATTENUATION	
		INCHES	mm		INCHES	mm	pF/ft	pF/m			MHz	dB/100'
C1160 RG 11/U Type JAN-C-17A Type 	18 Ga. (7/26) Tinned Copper 6.1 Ω/Mft.	Solid PE		95% Bare Copper Braid 1.2 Ω/Mft.	PVC		20.50	67.26	66	75	1	0.20
		0.285	6.55		0.400	10.16						
C5025 RG 11/U Type 	14 Ga. Solid Copper-Clad Steel 11.4 Ω/Mft.	Foam PE		97% Bare Copper Braid 1.2 Ω/Mft.	Black PE		16.20	53.15	83	75	1	0.30
		0.285	7.24		0.405	10.29						
C5029 RG 11/U Type UL CL2, CM c(UL) CM 	14 Ga. Solid Copper-Clad Steel 11.4 Ω/Mft.	Foam PE		100% Flexfoil® Bonded +61% Tinned Copper Braid 3.0 Ω/Mft.	PVC		16.20	53.15	85	75	1	0.30
		0.280	7.11		0.395	10.03						
C5034 RG 11/U Type 1354 	14 Ga. Solid Copper-Clad Steel 11.4 Ω/Mft.	Foam PE		100% Flexfoil® Bonded +40% Aluminum Braid 5.3 Ω/Mft.	PVC		16.20	53.15	85	75	1	0.30
		0.280	7.11		0.395	10.03						

Data subject to change.



RG 11/U Type

Product Construction:

Conductor:

- Copper per ASTM B3
- Copper-clad steel per ASTM B3

Insulation/Core:

- Foam polyethylene (PE)
- Foam fluoropolymer (FEP)

Shield:

- Tinned, bare copper or aluminum braid
- Flexfoil® shield

Jacket:



- Premium PVC compound or PVDF compound

Packaging:

- Please contact Customer Service for packaging and color options

Applications:

- Suitable for RF signal transmission
- Broadcast digital video
- MATV
- CATV
- Drop cable

CATALOG NUMBER	AWG SIZE NOM. DCR	INSULATION MATERIAL		SHIELD COVERAGE NOM SHLD DCR	NOMINAL O.D.		NOMINAL CAPACITANCE		VELOCITY OF PROPAGATION, %	NOMINAL IMPEDANCE, Ω	NOMINAL ATTENUATION	
		INCHES	mm		INCHES	mm	pF/ft	pF/m			MHz	dB/100'
C5039 RG 11/U Type UL CL2, CATV, CM CSA CMG 	14 Ga. Solid Copper-Clad Steel 11.4 Ω/Mft.	Foam PE		100% Flexfoil® Bonded +60% Aluminum Braid 4.6 Ω/Mft.	PVC		16.20	53.15	85	75	1	0.30
		0.280	7.11		0.395	10.03						10
C5044 RG 11/U Type Quad-Shield UL CL2, CATV, CM CSA CMG 	14 Ga. Solid Copper-Clad Steel 11.4 Ω/Mft.	Foam PE		(2) 100% Flexfoil® 1st Bonded (1) 61% (2) 40% Aluminum Braids 3.4 Ω/Mft.	PVC		16.20	53.15	85	75	1	0.30
		0.280	7.11		0.405	10.29						10
C3528 RG 11/U Type Plenum UL CL2P, CMP c(UL) CMP CATVP 	14 Ga. Solid Copper-Clad Steel 11.4 Ω/Mft.	Fluoropolymer		100% Flexfoil® +60% Aluminum Braids 4.6 Ω/Mft.	PVDF		16.00	52.50	82	75	1	0.15
		0.280	7.11		0.351	8.92						10

Data subject to change.

RG 11/U Type

Product Construction:

Conductor:

- Stranded or solid copper per ASTM B3
- Copper-clad steel per ASTM B869

Insulation/Core:

- Foam polyethylene (PE)
- Foam fluoropolymer (FEP)

Shield:

- Bare copper or aluminum braid
- Flexfoil® shield

Jacket:

- Premium fluoropolymer (PVDF) compound or premium polyethylene (PE) compound

Packaging:

- Please contact Customer Service for packaging and color options

Applications:

- Suitable for RF signal transmission
- Broadcast/digital video
- MATV
- CATV
- Drop cable
- HDTV
- Direct burial

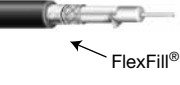
CATALOG NUMBER	AWG SIZE NOM. DCR	INSULATION MATERIAL		SHIELD COVERAGE NOM SHLD DCR	NOMINAL O.D.		NOMINAL CAPACITANCE		VELOCITY OF PROPAGATION, %	NOMINAL IMPEDANCE, Ω	NOMINAL ATTENUATION	
		INCHES	mm		INCHES	mm	pF/ft	pF/m			MHz	dB/100'
C3529 RG 11/U Type Quad-Shield Plenum UL CL2P, CMP c(UL) CMP CATVP 	14 Ga. Solid Copper-Clad Steel 11.4 Ω/Mft.	Fluoropolymer		(2) 100% Flexfoil® (1) 60% (2) 40% Aluminum Braids 3.4 Ω/Mft.	PVDF		16.00	52.50	82	75	1	0.15
		0.280	7.11		0.372	9.45						
C5043 RG 11/U Type MoistureGuard™ Direct Burial, Flooded 	14 Ga. Solid Copper-Clad Steel 11.4 Ω/Mft.	Foam PE		100% Flexfoil® Bonded +60% Aluminum Braid w/water block 5.3 Ω/Mft.	Black PE		16.20	53.15	85	75	1	0.30
		0.280	7.11		0.395	10.03						
											50	1.09
											100	1.49
											200	2.35
											500	3.94
											1000	6.19
											1450	7.45
											1800	8.30
											2200	9.18
											1	0.30
											10	0.70
											50	0.90
											100	1.30
											200	1.90
											500	3.00
											1000	4.40

Data subject to change.



RG 11/U Type Serial Digital Interface (SDI) Precision Cable

Extended-Distance, 75 Ohm High-End Coaxial Cables for Exacting Video, Analog & Digital Applications

Product Construction:

Conductor:

- Copper per ASTM B3

Insulation/Core:

- Foam polyethylene (PE)
- Foam fluoropolymer (FEP)

Shield:

- Bare copper or tinned copper
- Flexfoil® shield

Jacket:





- Premium PVC compound or fluoropolymer

Packaging:

- Please contact Customer Service for packaging and color options

Applications:

- Suitable for RF signal transmission
- Broadcast-grade Serial Digital Interface (SDI)
- Analog/digital video
- MATV
- CATV
- CCTV†
- Drop cable
- HDTV

CATALOG NUMBER	AWG SIZE NOM. DCR	INSULATION MATERIAL		SHIELD COVERAGE NOM SHLD DCR	NOMINAL O.D.		NOMINAL CAPACITANCE		VELOCITY OF PROPAGATION, %	NOMINAL IMPEDANCE, Ω	NOMINAL ATTENUATION										
		INCHES	mm		INCHES	mm	pF/ft	pF/m			MHz	dB/100'									
395058† RG 11/U Type UL CM c(UL) CMG 	14 Ga. Solid Bare Copper 2.6 Ω/Mft.	Foam PE		95% Bare Copper Braid 1.2 Ω/Mft.	Flame-Retardant PVC		16.20	52.50	84	75	1	0.17									
		0.285	7.24		0.405	10.29					10	0.35	50	0.90	100	1.30	200	1.90	400	2.90	540
395029 RG 11/U Type UL CMR c(UL) CMG 	14 Ga. Solid Bare Copper 2.6 Ω/Mft.	Foam PE		Dual Flexfoil® + 95% Tinned Copper Braid 1.5 Ω/Mft.	Flame-Retardant PVC		16.20	53.10	83	75	1	0.15									
		0.280	7.11		0.405	10.29					3.6	0.28	135	1.62	270	2.31	540	3.29	1500	5.60	2250
495015† RG 11/U Type UL CMP c(UL) CMP 	14 Ga. Solid Bare Copper 2.6 Ω/Mft.	Fluoropolymer		95% Bare Copper Braid 1.2 Ω/Mft.	PVDF		16.20	52.50	84	75	1	0.17									
		0.280	7.11		0.351	8.92					10	0.35	50	0.90	100	1.30	200	1.90	400	2.90	540
495016† RG 11/U Type UL CMP c(UL) CMP 	14 Ga. Solid Bare Copper 2.6 Ω/Mft.	Fluoropolymer		Dual Flexfoil® + 60% AL Braid 3.0 Ω/Mft.	PVDF		16.20	53.10	84	75	1	0.15									
		0.280	7.11		0.351	8.92					10	0.40	50	1.00	100	1.50	200	2.20	400	3.30	540
495027 RG 11/U Type UL CMP c(UL) CMP 	14 Ga. Solid Bare Copper 2.6 Ω/Mft.	Fluoropolymer		Dual Flexfoil® + 95% Tinned Copper Braid Shield 1.5 Ω/Mft.	PVDF		16.20	53.10	84	75	1	0.12									
		0.280	7.11		0.348	8.84					3.6	0.24	135	1.63	270	2.49	540	3.89	1500	7.88	2250

Data subject to change.

RG 58/U Type

Product Construction:

Conductors:

- Copper per ASTM B3
- Tinned copper per ASTM B33

Insulation/Core:

- Solid and foam polyethylene (PE)
- Solid and foam fluoropolymer (FEP)

Shield:

- Tinned copper braid

Jacket:





- Premium PVC compound

Packaging:

- Please contact Customer Service for packaging and color options

Applications:

- Suitable for RF signal transmission
- Broadcast
- LAN & data transmission

CATALOG NUMBER	AWG SIZE NOM. DCR	INSULATION MATERIAL		SHIELD COVERAGE NOM SHLD DCR	NOMINAL O.D.		NOMINAL CAPACITANCE		VELOCITY OF PROPAGATION, %	NOMINAL IMPEDANCE, Ω	NOMINAL ATTENUATION	
		INCHES	mm		INCHES	mm	pF/ft	pF/m			MHz	dB/100'
C1155 RG 58 C/U Type MIL-C-17G Type 	20 Ga. (19/.0071) Tinned Copper 10.8 Ω/Mft.	Solid PE		95% Tinned Copper Braid 4.3 Ω/Mft.	Non-Contaminating PVC		30.80 101.05		66	50	1	0.42
		0.116	2.95		0.195	4.95					10	1.50
C1166 RG 58/U Type JAN-C-17A Type 	20 Ga. Solid Bare Copper 10.1 Ω/Mft.	Solid PE		95% Tinned Copper Braid 4.3 Ω/Mft.	PVC		30.00 98.43		66	50	1	0.40
		0.116	2.95		0.195	4.95					10	1.20
C1188 RG 58 A/U Type UL CL2, CM CSA CMG 	20 Ga. (19/32) Tinned Copper 9.5 Ω/Mft.	Foam PE		95% Tinned Copper Braid 4.3 Ω/Mft.	PVC		26.00 85.31		78	50	1	0.45
		0.114	2.90		0.195	4.95					10	1.42
C3519 RG 58/U Type Plenum UL CL2P, CMP c(UL) CMP 	19 Ga. Solid Bare Copper 8.1 Ω/Mft.	Fluoropolymer		95% Tinned Copper Braid 5.5 Ω/Mft.	Flexguard® PVC		25.00 82.00		82	50	1	0.40
		0.102	2.59		0.161	4.09					10	1.30

Data subject to change.



RG 59/U Type

Product Construction:

Conductors:

- Copper per ASTM B3
- Copper-clad steel per ASTM B869
- Twisted pair color code: black and red

Insulation/Core:

- Solid and cellular polyethylene (PE) or foam fluoropolymer (FEP)

Shield:

- Bare copper braid

Jacket:







- Premium PVC compound or PE compound

Packaging:

- Please contact Customer Service for packaging and color options

Applications:

- Suitable for RF signal transmission
- CATV
- MATV
- CCTV†
- Local Area Network
- Digital video
- Monitor/VDT display

CATALOG NUMBER	AWG SIZE NOM. DCR	INSULATION MATERIAL		SHIELD COVERAGE NOM SHLD DCR	NOMINAL O.D.		NOMINAL CAPACITANCE		VELOCITY OF PROPAGATION, %	NOMINAL IMPEDANCE, Ω	NOMINAL ATTENUATION	
		INCHES	mm		INCHES	mm	pF/ft	pF/m			MHz	dB/100'
C1102 RG 59/U Type 	20 Ga. Solid Copper-Clad Steel 45.9 Ω/Mft.	Foam PE		95% Bare Copper Braid 3.5 Ω/Mft.	Black PE		17.30	56.76	82	75	1	0.26
		0.146	3.71		0.242	6.15					10	0.82
C1104 RG 59/U Type UL 1354 	22 Ga. Solid Copper-Clad Steel 73.4 Ω/Mft.	Solid PE		95% Bare Copper Braid 2.6 Ω/Mft.	PVC		20.50	67.26	66	73	1	0.41
		0.146	3.71		0.242	6.15					10	0.99
C1135 RG 59/U Type UL CL2, CATV, CM CSA CMG UL 1354 	22 Ga. Solid Copper-Clad Steel 73.4 Ω/Mft.	Foam PE		95% Bare Copper Braid 2.6 Ω/Mft.	PVC		16.30	53.48	78	80	1	0.42
		0.146	3.71		0.242	6.15					10	0.92
C1103† RG 59/U Type UL CL2, CATV, CM CSA CMG UL 1354 	22 Ga. (7/30) Bare Copper 14.8 Ω/Mft.	Foam PE		95% Bare Copper Braid 2.6 Ω/Mft.	PVC		17.00	55.78	78	76	1	0.26
		0.146	3.71		0.242	6.15					10	0.91
C1142† RG 59/U Type UL CL2, CATV, CM CSA CMG UL 1354 	20 Ga. Solid Bare Copper 10.1 Ω/Mft.	Foam PE		95% Bare Copper Braid 2.6 Ω/Mft.	PVC		16.20	53.15	78	71	1	0.25
		0.146	3.71		0.234	5.94					10	0.78
C1106 RG 59B/U Type MIL-C-17D Type UL 1354 	23 Ga. Solid Copper-Clad Steel 68.5 Ω/Mft.	Solid PE		95% Bare Copper Braid 2.6 Ω/Mft.	Non-Contaminating PVC		21.00	68.90	66	73	1	0.44
		0.146	3.71		0.242	6.15					10	1.02
C8030† RG 59/U Type +18 AWG Unshielded Pair UL CMP c(UL) CMP 	20 AWG Solid BC Coax 18 AWG (7/26) Unshielded Pair	FEP		95% Bare Copper Braid	Flexguard® PVC		16.30	53.48	83	75	1	0.78
		0.135	3.43		0.200	5.08					10	1.90
		PVC		Unshielded Pair	X	X					50	1.98
		0.006	0.15		0.383	9.73					100	2.80

Data subject to change.



RG 59/U Type

Product Construction:

Conductors:

- Copper per ASTM B3
- Copper-clad steel per ASTM B869
- Twisted pair color code: black and red

Insulation/Core:

- Solid and foam polyethylene (PE)

Shield:

- Tinned, bare copper or aluminum braid
- Flexfoil® shield

Jacket:



- Premium PVC compound

Packaging:

- Please contact Customer Service for packaging and color options

Applications:

- Suitable for RF signal transmission
- MATV
- CATV
- CCTV†
- Local Area Network
- Monitor/VDT display
- Analog video
- Digital video

CATALOG NUMBER	AWG SIZE NOM. DCR	INSULATION MATERIAL		SHIELD COVERAGE NOM SHLD DCR	NOMINAL O.D.		NOMINAL CAPACITANCE		VELOCITY OF PROPAGATION, %	NOMINAL IMPEDANCE, Ω	NOMINAL ATTENUATION	
		INCHES	mm		INCHES	mm	pF/ft	pF/m			MHz	dB/100'
C1110 RG 59/U Type 	22 Ga. Solid Copper-Clad Steel 73.4 Ω/Mft.	Solid PE		70% Bare Copper Braid 4.5 Ω/Mft.	PVC		22.00 72.18	66	73	1 10 50 100 200 500 1000 1450 1800 2200 3000	0.41 0.99 2.38 3.49 5.09 8.43 13.03 15.69 17.48 19.33 22.57	
		0.146	3.71		0.242	6.15						
C8025† RG 59/U Type +22 AWG Shielded Pair UL CL2, CM c(UL) CM 	22 AWG (7/30) Bare Copper Coax 22 AWG (7/30) Shielded Pair	Foam PE		95% Bare Copper Braid	PVC		17.00 57.78	78	76	1 10 50 100 200 500 1000	0.26 0.91 2.90 3.00 4.33 7.03 10.64	
		0.144	3.66		0.242	6.147						
		Premium PVC		100% Flexfoil® Al/PP Shielded	0.445	11.30						
		0.013	0.33									

Data subject to change.



RG 59/U Type

Product Construction:

Conductors:

- Copper-clad steel per ASTM B869

Insulation/Core:

- Foam polyethylene (PE)

Shield:

- Aluminum braid
- Flexfoil® shield

Jacket:



- Premium PVC compound

Packaging:

- Please contact Customer Service for packaging and color options

Applications:

- Suitable for RF signal transmission
- CATV
- MATV
- Drop cable
- Local Area Network
- Monitor/VDT display

CATALOG NUMBER	AWG SIZE NOM. DCR	INSULATION MATERIAL		SHIELD COVERAGE NOM SHLD DCR	NOMINAL O.D.		NOMINAL CAPACITANCE		VELOCITY OF PROPAGATION, %	NOMINAL IMPEDANCE, Ω	NOMINAL ATTENUATION	
		INCHES	mm		INCHES	mm	pF/ft	pF/m			MHz	dB/100'
C5770 RG 59/U Type UL CL2, CM CSA CMG 	22 Ga. Solid Copper-Clad Steel 73.4 Ω/Mft.	Foam PE		100% Flexfoil® Bonded + 40% Aluminum Braid 11.0 Ω/Mft.	PVC		16.00	52.50	78	80	1	0.50
		0.144	3.66		0.231	5.87					10	1.00
C5780 RG 59/U Type MATV UL CL2, CM CSA CMG 	20 Ga. Solid Copper-Clad Steel 45.9 Ω/Mft.	Foam PE		100% Flexfoil® Bonded + 40% Aluminum Braid 11.0 Ω/Mft.	PVC		16.20	53.15	85	75	1	0.60
		0.144	3.66		0.234	5.94					10	1.20
											50	2.30
											100	3.30
											200	4.10
											500	6.50
											1000	9.40
											1450	11.32
											1800	12.61
											2200	13.94
											3000	16.28
											1	0.60
											10	1.20
											50	1.95
											100	2.70
											200	3.70
											500	5.70
											1000	8.12
											1450	9.78
											1800	10.89
											2200	12.04
											3000	14.06

Data subject to change.

RG 59/U Type

Product Construction:

Conductors:

- Copper-clad steel per ASTM B869
- Copper per ASTM B3
- Twisted pair color code: black and red

Insulation/Core:

- Foam polyethylene (PE)

Shield:

- Bare copper or aluminum braid
- Flexfoil® shield

Jacket:





- Premium PVC compound

Packaging:

- Please contact Customer Service for packaging and color options

Applications:

- Suitable for RF signal transmission
- MATV
- CCTV†
- Local Area Network
- Monitor/VDT display
- Direct burial

CATALOG NUMBER	AWG SIZE NOM. DCR	INSULATION MATERIAL		SHIELD COVERAGE NOM SHLD DCR	NOMINAL O.D.		NOMINAL CAPACITANCE		VELOCITY OF PROPAGATION, %	NOMINAL IMPEDANCE, Ω	NOMINAL ATTENUATION			
		INCHES	mm		INCHES	mm	pF/ft	pF/m			MHz	dB/100'		
C3526 RG 59/U Type Plenum UL CL2P, CMP c(UL) CMP 	20 Ga. Solid Copper-Clad Steel 45.9 Ω/Mft.	Fluoropolymer		100% Flexfoil® +80% Aluminum Braid 10.7 Ω/Mft.	Flexguard® PVC		16.00	52.50	84	75	1	0.34		
		0.135	3.429		0.202	5.13							10	1.07
C3500 RG 59/U Type Plenum UL CL2P, CMP c(UL) CMP 	20 Ga. Solid Copper-Clad Steel 45.9 Ω/Mft.	Fluoropolymer		95% Bare Copper Braid 1.9 Ω/Mft.	Flexguard® PVC		16.50	54.14	83	75	1	0.78		
		0.135	3.429		0.201	5.11							10	1.90
C8027† RG 59/U Type +18 AWG Shielded Pair UL CL2, CM c(UL) CM 	22 AWG (7/30) Bare Copper Coax 18 AWG (16/30) Shielded Pair	Foam PE		95% Bare Copper Braid 125% Flexfoil® Al/PP Shielded	PVC		17.00	55.78	78	76	1	0.26		
		0.144	3.66		0.242	6.15							10	0.91
		Premium PVC			0.480	12.19							50	2.09
		0.016	0.41		X	X							100	3.00
C8028† RG 59/U Type +18 AWG Unshielded Pair UL CL2, CM c(UL) CM 	20 AWG Solid Bare Copper Coax 18 AWG (7/26) Unshielded Pair	Foam PE		95% Bare Copper Braid Unshielded Pair	PVC		16.20	53.15	78	71	1	0.25		
		0.144	3.66		0.238	6.05							10	0.78
		Premium PVC			0.440	11.18							50	1.97
		0.010	0.25		X	X							100	2.70

Data subject to change.



RG 59/U Serial Digital Interface Cable

75 Ohm High-End Coaxial Cables for Video, Analog & Digital Applications

Product Construction:

Conductors:

- Copper per ASTM B3

Insulation/Core:

- Foam polyethylene (PE)
- Foam fluoropolymer (FEP)

Shield:

- Tinned copper braid
- Flexfoil® shield

Jacket:



- Premium PVC compound

Packaging:

- Please contact Customer Service for packaging and color options

Applications:

- Suitable for RF signal transmission
- Broadcast-grade
- MATV
- CATV
- Precision video-analog/digital
- Serial digital interface cable (SDI)

CATALOG NUMBER	AWG SIZE NOM. DCR	INSULATION MATERIAL		SHIELD COVERAGE NOM SHLD DCR	NOMINAL O.D.		NOMINAL CAPACITANCE		VELOCITY OF PROPAGATION, %	NOMINAL IMPEDANCE, Ω	NOMINAL ATTENUATION	
		INCHES	mm		INCHES	mm	pF/ft	pF/m			MHz	dB/100'
395025 RG 59/U Type UL CMR c(UL) CMG 	20 Ga. Solid Bare Copper 10.5 Ω/Mft.	Foam PE		Bi-Metal Foil +95% Tinned Copper Braid Shield 3.5 Ω/Mft.	Flame-Retardant PVC		16.30	53.40	83	75	1	0.29
		0.146	3.71		0.242	6.15					135	2.70
495023 RG 59/U Type UL CMP c(UL) CMP 	20 Ga. Solid Bare Copper 10.5 Ω/Mft.	Fluoropolymer		Bi-Metal Foil +95% Tinned Copper Braid Shield 3.2 Ω/Mft.	Flexguard® PVC		16.10	53.00	84	75	1	0.29
		0.135	3.43		0.199	5.05					10	1.03
495028+ RG 59/U Type UL CMP c(UL) CMP 	20 Ga. Solid Bare Copper 10.5 Ω/Mft.	Fluoropolymer		95% Bare Copper Braid Shield 2.7 Ω/Mft.	Flexguard® PVC		16.00	52.50	84	75	1	0.24
		0.139	3.43		0.197	5.00					10	1.41
											50	1.83
											100	2.64
											200	3.84
											400	5.64

Data subject to change.

RG 59/U (RGB) Multi-Channel Digital/Precision Cable

75 Ohm High-End Coaxial Cables for Video, Analog & Monitor Applications

Product Construction:

Conductors:

- Solid bare copper per ASTM B3

Insulation/Core:

- Foam polyethylene (PE)

Shield:

- Tinned copper braid
- Flexfoil® shield

Jacket:





- Outer jacket: matte finish thermoplastic elastomer (TPE)
- Inner jacket: flame-retardant PVC

Packaging:

- Please contact Customer Service for packaging and color options

Applications:

- Suitable for RF signal transmission
- Broadcast
- HDTV
- Video-analog/digital
- Monitor applications

CATALOG NUMBER	AWG SIZE NOM. DCR	INSULATION MATERIAL		SHIELD COVERAGE NOM SHLD DCR	NOMINAL O.D.		NOMINAL CAPACITANCE		VELOCITY OF PROPAGATION, %	NOMINAL IMPEDANCE, Ω	NOMINAL ATTENUATION			
		INCHES	mm		INCHES	mm	pF/ft	pF/m			MHz	dB/100'		
RG 59/U SERIAL DIGITAL INTERFACE (SDI), PRECISION COAX, RISER RATED														
395025-3 RG 59/U Type UL CMR c(UL) CMG 	20 Ga. 3/Cond. Solid Bare Copper 10.5 Ω/Mft.	Foam PE		Bi-Metal Foil +95% Tinned Copper Braid Shield 3.5 Ω/Mft.	Inner: Flame-Retardant PVC		16.30	52.40	83	75	1	0.29		
		0.146	3.71		Outer: TPE Matte								71.5	2.10
					0.610	15.49								
270	3.80													
540	5.47													
1500	9.30													
2250	11.51													
3000	13.31													
395025-4 RG 59/U Type UL CMR c(UL) CMG 	20 Ga. 4/Cond. Solid Bare Copper 10.5 Ω/Mft.	Foam PE		Bi-Metal Foil +95% Tinned Copper Braid Shield 3.5 Ω/Mft.	Inner: Flame-Retardant PVC		16.30	52.40	83	75	1	0.29		
		0.146	3.71		Outer: TPE Matte								71.5	2.10
					0.670	17.04								
270	3.80													
540	5.47													
1500	9.30													
2250	11.51													
3000	13.31													
395025-5 RG 59/U Type UL CMR c(UL) CMG 	20 Ga. 5/Cond. Solid Bare Copper 10.5 Ω/Mft.	Foam PE		Bi-Metal Foil +95% Tinned Copper Braid Shield 3.5 Ω/Mft.	Inner: Flame-Retardant PVC		16.30	52.40	83	75	1	0.29		
		0.146	3.71		Outer: TPE Matte								71.5	2.10
					0.745	18.87								
270	3.80													
540	5.47													
1500	9.30													
2250	11.51													
3000	13.31													
395025-10 RG 59/U Type UL CMR c(UL) CMG 	20 Ga. 10/Cond. Solid Bare Copper 10.5 Ω/Mft.	Foam PE		Bi-Metal Foil +95% Tinned Copper Braid Shield 3.5 Ω/Mft.	Inner: Flame-Retardant PVC		16.30	52.40	83	75	1	0.29		
		0.146	3.71		Outer: TPE Matte								71.5	2.10
					1.110	28.19								
270	3.80													
540	5.47													
1500	9.30													
2250	11.51													
3000	13.31													

Data subject to change.



RG 59/U (RGB) Miniature Multi-Channel Precision Cable

75 Ohm High-End Coaxial Cables for Video, Analog & Monitor Applications

Product Construction:

Conductors:

- Solid bare copper per ASTM B3

Insulation/Core:

- Foam polyethylene (PE)

Shield:

- Tinned copper braid
- Flexfoi® shield

Jacket:



- Outer jacket: matte finish thermoplastic elastomer (TPE)
- Inner jacket: flame-retardant PVC

Packaging:

- Please contact Customer Service for packaging and color options

Applications:

- Suitable for RF signal transmission
- Broadcast
- HDTV
- Video-analog/digital
- Monitor applications

CATALOG NUMBER	AWG SIZE NOM. DCR	INSULATION MATERIAL		SHIELD COVERAGE NOM SHLD DCR	NOMINAL O.D.		NOMINAL CAPACITANCE		VELOCITY OF PROPAGATION, %	NOMINAL IMPEDANCE, Ω	NOMINAL ATTENUATION	
		INCHES	mm		INCHES	mm	pF/ft	pF/m			MHz	dB/100'
RG 59/U (RGB) RISER RATED												
395035-3 RG 59/U Type UL CMR c(UL) CMG 	26 Ga. 3/Cond. Stranded (7/34) Bare Copper 39.7 Ω/Mft.	Foam PE		Bi-Metal Foil +95% Tinned Copper Braid Shield 8.6 Ω/Mft.	Inner: Flame-Retardant PVC Outer: TPE Matte		17.30	56.74	78	75	1	0.56
		0.089	2.26		10	1.48						
395035-4 RG 59/U Type UL CMR c(UL) CMG 	26 Ga. 4/Cond. Stranded (7/34) Bare Copper 39.7 Ω/Mft.	Foam PE		Bi-Metal Foil +95% Tinned Copper Braid Shield 8.6 Ω/Mft.	Inner: Flame-Retardant PVC Outer: TPE Matte		17.30	56.74	78	75	1	0.56
		0.089	2.26		10	1.48						
395035-5 RG 59/U Type UL CMR c(UL) CMG 	26 Ga. 5/Cond. Stranded (7/34) Bare Copper 39.7 Ω/Mft.	Foam PE		Bi-Metal Foil +95% Tinned Copper Braid Shield 8.6 Ω/Mft.	Inner: Flame-Retardant PVC Outer: TPE Matte		17.30	56.74	78	75	1	0.56
		0.089	2.26		10	1.48						

Data subject to change.

RG 62/U Type

Product Construction:

Conductors:

- Copper-clad steel per ASTM B869

Insulation/Core:

- Semi-solid polyethylene (PE)
- Foam fluoropolymer (FEP)

Shield:

- Bare copper braid

Jacket:



- Premium PVC compound

Packaging:

- Please contact Customer Service for packaging and color options

Applications:

- Suitable for RF signal transmission
- Computer/networks

CATALOG NUMBER	AWG SIZE NOM. DCR	INSULATION MATERIAL		SHIELD COVERAGE NOM SHLD DCR	NOMINAL O.D.		NOMINAL CAPACITANCE		VELOCITY OF PROPAGATION, %	NOMINAL IMPEDANCE, Ω	NOMINAL ATTENUATION	
		INCHES	mm		INCHES	mm	pF/ft	pF/m			MHz	dB/100'
C1162 RG 62A/U Type MIL-C-17G Type UL 1354 	22 Ga. Solid Copper-Clad Steel 73.4 Ω/Mft.	Semi-Solid PE		95% Bare Copper Braid 2.6 Ω/Mft.	Non-Contaminating PVC		13.60 44.62	84	93	1 10 50 100 200 500 1000	0.38 0.85 1.90 2.70 3.80 5.90 8.70	
		0.146	3.71		0.242	6.15						
C1164 RG 62/U Type Computer Cable JAN-C-17A Type UL CL2, CM CSA CMG UL 1354 	22 Ga. Solid Copper-Clad Steel 73.4 Ω/Mft.	Semi-Solid PE		95% Bare Copper Braid 2.6 Ω/Mft.	PVC		13.60 44.62	84	93	1 10 50 100 200 500 1000	0.38 0.85 1.90 2.70 3.80 5.90 8.70	
		0.146	3.66		0.242	6.15						
C3520 RG 62/U Type Plenum UL CL2P, CMP c(UL) CMP 	22 Ga. Solid Copper-Clad Steel 54.7 Ω/Mft.	Fluoropolymer		95% Bare Copper Braid 1.9 Ω/Mft.	Flexguard® PVC		13.00 42.65	84	93	1 10 50 100 200 500 1000	0.30 0.90 1.90 2.70 3.80 5.90 8.34	
		0.145	3.56		0.201	5.11						

Data subject to change.



RG 174/U Type

Product Construction:
Conductors:

- Copper-clad steel per ASTM B869

Insulation/Core:

- Solid polyethylene (PE)

Shield:

- Tinned or bare copper braid

Jacket:

- Premium PVC compound

Packaging:

- Please contact Customer Service for packaging and color options

Applications:

- Suitable for RF signal transmission

CATALOG NUMBER	AWG SIZE NOM. DCR	INSULATION MATERIAL		SHIELD COVERAGE NOM SHLD DCR	NOMINAL O.D.		NOMINAL CAPACITANCE		VELOCITY OF PROPAGATION, %	NOMINAL IMPEDANCE, Ω	NOMINAL ATTENUATION				
		INCHES	mm		INCHES	mm	pF/ft	pF/m			MHz	dB/100'			
C1156 RG 174/U Type  1354	26 Ga. (7/34) Copper-Clad Steel 97.0 Ω /Mft.	Solid PE		88% Tinned Copper Braid 10.3 Ω /Mft.	PVC		30.80	101.05	66	50	1	1.90			
		0.060	1.52		0.103	2.62					10	3.30	50	5.80	100

Data subject to change.

RG 213/U Type

Product Construction:

Conductors:

- Copper per ASTM B3

Insulation/Core:

- Solid polyethylene (PE)

Shield:

- Bare copper braid

Jacket:

- Premium non-contaminating black PVC

Packaging:

- Please contact Customer Service for packaging and color options

Applications:

- Suitable for RF signal transmission

CATALOG NUMBER	AWG SIZE NOM. DCR	INSULATION MATERIAL		SHIELD COVERAGE NOM SHLD DCR	NOMINAL O.D.		NOMINAL CAPACITANCE		VELOCITY OF PROPAGATION, %	NOMINAL IMPEDANCE, Ω	NOMINAL ATTENUATION	
		INCHES	mm		INCHES	mm	pF/ft	pF/m			MHz	dB/100'
C1176A RG 213/U Type MIL-C-17G Type 	13 Ga. (7/21) Bare Copper 1.7 Ω/Mft.	Solid PE		95% Bare Copper Braid 1.2 Ω/Mft.	PVC		30.80	101.05	66	50	1	0.18
											10	0.62
		50	1.50									
		100	2.10									
		200	3.00									
500	5.03											
1000	8.20											

Data subject to change.



Twinaxial Cables

Product Construction:

Conductors:

- Copper per ASTM B3
- Tinned copper per ASTM B33

Insulation/Core:

- Solid and foam polyethylene (PE)
- Lo-Cap® polypropylene (PPE)

Shield:

- Tinned copper braid
- Flexfoil® shield

Jacket:



- Premium PVC compound

Packaging:

- Please contact Customer Service for packaging and color options

Applications:

- Programmable Logic Controllers (PLC)
- Data transmission
- Broadcast
- Computer

CATALOG NUMBER	AWG SIZE NOM. DCR	INSULATION MATERIAL		SHIELD COVERAGE NOM SHLD DCR	NOMINAL O.D.		NOMINAL CAPACITANCE		VELOCITY OF PROPAGATION, %	NOMINAL IMPEDANCE, Ω	NOMINAL ATTENUATION	
		INCHES	mm		INCHES	mm	pF/ft	pF/m			MHz	dB/100'
C8000 UL CL2  2498 80°C, 300V	20 Ga. (7/28) (1) Tinned Copper, (1) Bare Copper 9.5 Ω/Mft.	Solid PE Coded: Natural, Natural		100% Flexfoil® +90% Tinned Copper Braid 2.5 Ω/Mft.	PVC		15.50	50.86	66	100	1	0.40
		0.022	0.56		0.330	8.38					10	1.10
C8001 UL CL2, CM C(UL) CM  2464 60°C, 300V	20 Ga. (7/28) Tinned Copper 9.5 Ω/Mft.	Solid PE Coded: Natural, Blue		100% Flexfoil® +57% Tinned Copper Braid 4.1 Ω/Mft.	PVC		19.17	62.90	66	78	1	0.60
		0.020	0.51		0.242	6.15					10	2.10
C8014  2668 60°C, 30V	22 Ga. (19/34) Tinned Copper 15.0 Ω/Mft.	Lo-Cap® FPE Coded: Black, Yellow		100% Flexfoil® +22 AWG Tinned Copper Drain Wire 6.3 Ω/Mft.	PVC		8.80	28.87	78	150	1	0.40
		0.051	1.30		0.360	9.14					10	1.20

Data subject to change.

Commercial Audio/Video & Home Entertainment Cable 8



General Cable offers a variety of Gepco® and Carol® Brand wire and cable for audio/video and direct burial applications. From field production cable to microphone, snake, guitar and speaker cable, General Cable supports the increasingly demanding entertainment industry.

For extreme hard service, General Cable’s rubber microphone cables offer the ultimate in performance and service life. The rubber designs are highly flexible and designed to lie flat on studio floors, as well as provide high impact and abrasion resistance.

For outdoor and cold weather applications, microphone cable jacketed with Carolprene® provides the ultimate protection against ozone, oil and ultraviolet radiation.

These technically sophisticated cables are required to contain sources of interference and to protect against difficulties where they are unavoidable. In addition to providing the needed electrical characteristics, the cables are properly designed to handle demanding conditions, such as microphone hum, handling noise, crosstalk, electrostatic hum, SCR noise and common ground noise—either on stage, in a studio or at a remote venue.

For more information on these cables or for other special applications, please contact your General Cable sales representative.

Index	Page
Gepco® Brand Commercial A/V Solutions	157-161
Speaker Wire	162
Special Audio, Communication & Instrumentation	163-164
Microphone Cable, Multi-Conductor, Carolprene	165



Commercial A/V Solutions

Since 1981, Gepco® has been committed to the development and manufacture of cable and connectivity products for the broadcast and professional A/V markets. Through continual involvement in technology and by listening closely to its customers, Gepco has developed a collection of unique and innovative solutions for the professional broadcast market. Now, Gepco extends this exceptional quality and excellence—that has delivered confidence and performance to the broadcast industry—into commercial applications.

Excellence starts with innovative design. Produced with the same technology and process control utilized in the manufacture of cables for broadcast applications, the **Gepco® Brand Commercial A/V** line provides an unrivaled level of performance to the Commercial A/V Market. With integrated design, manufacturing, and quality control, Gepco delivers exceptional electrical and mechanical specifications to meet or exceed the requirements for the leading-edge audio, video, data and control formats found in Commercial A/V systems.

When demanding Commercial A/V applications require a pure, undiluted signal for exceptional results, Gepco Brand is the solution.



Custom Assembly Capabilities

Gepco's complete range of cable assemblies are made from an extensive line of Gepco Brand audio and video products. Gepco Audio, Video and Custom Assemblies are hand-terminated in the U.S.A. with premium connectors and may be produced in standard or custom configurations.



Cable Types for Almost Any Application

Our audio and video assemblies can be manufactured from almost any of Gepco's broad range of cables and industry-standard connectors. From microphone cables to component video snakes, Gepco provides cable assembly solutions for almost any commercial audio or video application.



Standard and Custom Capabilities

Each assembly is built to order, therefore, cable assemblies may easily be produced in custom configurations. Custom pin-outs and lengths can be made just as easily as standard configurations. This allows for proper interfacing with a variety of connector options while providing a clean installation devoid of excess cable.



The visual image is the core of any video system. Modern high resolution and High Definition video formats now demand an even greater degree of quality and bandwidth from the cable interconnect system. To bring a higher level of performance to commercial video applications, the Gepco® Brand commercial line of video cables are made using the same techniques and materials used in professional, studio-grade video coax. Every Gepco Brand video cable is built to exacting electrical and mechanical specifications then comprehensively tested and verified. As a result, the video image is transmitted with minimal loss or errors, delivering exceptionally true and clear images. Through precision, Gepco Brand video cables deliver your clearest vision.

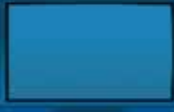

Plenum Cable Solution	Non-Plenum Cable Solution	Description
Broadband Coax - CATV - MATV - DBS (Color Code Chart A)		
C3524	C5886	RG 6 18 AWG Solid CCS, Bonded Foil, 80% AL Braid CMP/60% AL Braid CMR, PVC Natural CMP/Black CMR
C3525	C5889	RG 6 18 AWG Solid CCS, Quad-Shield Dual Foil, 60%/40% AL Braid, PVC Natural CMP/Black CMR
495027	395029	RG 11 14 AWG Solid BC, Dual Foil, 95% TC Braid, PVDF Natural CMP/PVC Black or White CMR
C3529	C5044	RG 11 14 AWG Solid CCS, Quad-Shield Dual Foil, 60%/40% AL Braid, PVDF White CMP/PVC Black CM
High Definition Coax - HDTV - Serial Digital Interface - SDI (Color Code Chart B)		
VSD2001TS	VSD2001	RG 6 18 AWG Solid BC, Foil, 95% TC Braid, PVC White CMP/Black, Brown, Red, Orange, Yellow, Green, Blue, Violet, Gray or White CMR
VHD1100TK	VHD1100	RG 11 14 AWG Solid BC, Foil, 95% TC Braid, PVDF White CMP/PVC Black CMR
VPM2000TS	VPM2000	RG 59 20 AWG Solid BC, Foil, 95% TC Braid, PVC White CMP/Black, Brown, Red, Orange, Yellow, Green, Blue, Violet, Gray or White CMR
VDM230TS	VDM230	Mini 23 AWG Solid BC, Foil, 95% TC Braid, PVC Black or White CMP/Black, Brown, Red, Orange, Yellow, Green, Blue, Violet, Gray or White CMR
	VDM250	Mini 25 (7x33) AWG BC, Foil, 95% TC Braid, PVC Black CMR
	VDM250D*	Dual Coax Mini 25 (7x33) AWG BC, Foil, 95% TC Braid, PVC Black (*Not UL Rated)
Component Video RGB Coax Cable (Color Code Chart B)		
SV253SP	SV253SR	3 Coax Mini 25 AWG Solid BC, Foil, 95% TC Braid, Red, Green Blue, Outer Jacket PVC White CMP/Black CMR
SV254SP	SV254SR	4 Coax Mini 25 AWG Solid BC, Foil, 95% TC Braid, Red, Green, Blue, Yellow, Outer Jacket PVC White CMP/Black CMR
SV255SP	SV255SR	5 Coax Mini 25 AWG Solid BC, Foil, 95% TC Braid, Red, Green, Blue, Yellow, White, Outer Jacket PVC White CMP/Black CMR
	SV256SR	6 Coax Mini 25 AWG Solid BC, Foil, 95% TC Braid, Red, Green, Blue, Yellow, White, Black, Outer Jacket PVC Black CMR
	SV253STR	3 Coax Mini 25 (7x33) AWG BC, Foil, 95% TC Braid, Red, Green, Blue, Outer Jacket TPE Black CM
	SV254STR	4 Coax Mini 25 (7x33) AWG BC, Foil, 95% TC Braid, Red, Green, Blue, Yellow, Outer Jacket TPE Black CM
	SV255STR	5 Coax Mini 25 (7x33) AWG BC, Foil, 95% TC Braid, Red, Green, Blue, Yellow, White, Outer Jacket TPE Black CM
	SV256STR	6 Coax Mini 25 (7x33) AWG BC, Foil, 95% TC Braid, Red, Green, Blue, Yellow, White, Black, Outer Jacket TPE Black CM
	VS32001	3 Coax RG 6 18 AWG Solid BC, Foil, 95% TC Braid, Red, Green, Blue, Outer Jacket TPE Black CMR
	VS42001	4 Coax RG 6 18 AWG Solid BC, Foil, 95% TC Braid, Red, Green, Blue, Yellow, Outer Jacket TPE Black CMR
	VS52001	5 Coax RG 6 18 AWG Solid BC, Foil, 95% TC Braid, Red, Green, Blue, Yellow, White, Outer Jacket TPE Black CMR
	VS62001*	6 Coax RG 6 18 AWG Solid BC, Foil, 95% TC Braid, Red, Green, Blue, Yellow, White, Black, Outer Jacket TPE Black (*Not UL Rated)
Composite Cable - Video + Audio or Data (Color Code Chart B)		
RGB62TS		6 Coax Mini 26 (7x34) AWG TC, Foil, 95% TC Braid, Red, Green, Blue, Yellow, White, Black + 22 (7x30) AWG TC 2 Pr, Outer Jacket PVC White CL2P
	RGB62	6 Coax Mini 26 AWG Solid BC, Foil, 95% TC Braid, Red, Green, Blue, Yellow, White, Black + 24 (7x32) AWG TC 2 Pr, Outer Jacket Flexible TPE Black CM
RGB644TS		6 Coax Mini 26 (7x34) AWG TC, Foil, 95% TC Braid, Red, Green, Blue, Yellow, White, Black + 26 (7x34) AWG TC 4 Pr + 4 Power 20 (7x28) AWG TC, Outer Jacket PVC White CL2P
	RGB644	6 Coax Mini 26 AWG Solid BC, Foil, 95% TC Braid, Red, Green, Blue, Yellow, White, Black + 26 (7x34) AWG TC 4 Pr + 4 Power 20 (7x28) AWG TC, Outer Jacket Flexible TPE Black CM
	256VT9C5	6 Coax Mini 25 AWG Solid BC, Foil, 95% TC Braid, Red, Green, Blue, Yellow, White, Black + 1 Cat 5e, Outer Jacket TPE Black CM
	VA2/2TP*	2 Coax Mini 25 (7x33) BC, Foil, 95% TC Braid, Black, White + 22 (7x30) AWG TC 2 Pr, Outer Jacket TPE Black (*Not UL Rated)
	VA2/3TP*	2 Coax Mini 25 (7x33) BC, Foil, 95% TC Braid, Black, White + 22 (7x30) AWG TC 3 Pr, Outer Jacket TPE Black (*Not UL Rated)
	VA2/3*	2 Coax 20 AWG Solid BC, Foil, 95% TC Braid, Black, White + 22 (7x30) AWG TC 3 Pr, Outer Jacket TPE Black (*Not UL Rated)
	VA2/4*	2 Coax 20 AWG Solid BC, Foil, 95% TC Braid, Black, White + 22 (7x30) AWG TC 4 Pr, Outer Jacket TPE Black (*Not UL Rated)
	VA2/5*	2 Coax 20 AWG Solid BC, Foil, 95% TC Braid, Black, White + 22 (7x30) AWG TC 5 Pr, Outer Jacket TPE Black (*Not UL Rated)
Low Skew Video Cable (Color Code Chart A)		
E3842S	E1842S	4 UTP 24 AWG Solid BC 2.2nS/100m, PVC Green CMP/Maroon CMR
E3843S	E1843S	4 UTP 23 AWG Solid BC 2.2nS/100m, PVC Green CMP/Maroon CMR
CCTV - Coax (Color Code Chart A)		
495035	395011	RG 6 18 AWG Solid BC, 95% BC Braid, PVC Natural CMP/Black or White CMR
495028	C1142	RG 59 20 AWG Solid BC, 95% BC Braid, PVC Natural CMP/Black CM
	C8025	Siamese RG 59 22 AWG BC, 95% BC Braid + 22 (7x30) AWG, Foil, PVC Black CM
C8030	C8028	Siamese RG 59 20 AWG Solid BC, 95% BC Braid + 18 (7x26) AWG UTP, PVC Natural CMP/Black CM
50 Ω Coax (Color Code Chart A)		
C5779		50 Ω RG 58 20 (19x32) AWG TC, Bonded Foil, 81% TC Braid, PVC Gray CM



Every component in an audio system is crucial, especially for the integrity and quality of the cable interconnections. The audio cable directly affects the power distribution, imaging and response of the audio signal. Through utilization of premium-grade compounds, high-purity copper conductors and precision tolerances, the Gepco® Brand commercial line of audio cables reduces loss, minimizes noise and ensures a true, clear and accurate signal transfer from microphone signal inputs all the way through to speaker outputs.

Cable Solution Description

Microphone Cable (Color Code Chart B)

MM1024*	26 (30x40) AWG TC 4 Cond, 95% TC Braid, Quad Star, PVC Black (*Not UL Rated)
MP1201*	24 (41x40) AWG BC 4 Cond, 95% TC Braid, Quad Star, PVC Black (*Not UL Rated)
MP1022*	24 (41x40) AWG TC 2 Cond, 95% TC Braid, PVC Black (*Not UL Rated)
M1042*	20 (26x34) AWG TC 2 Cond 95% TC Braid, TPE Black (*Not UL Rated)

Guitar/Musical Instruments Cables - Low Capacitance (Color Code Chart B)

GLC20*	20 (41x36) AWG BC 1 Cond 95% BC Braid, PVC Black (*Not UL Rated)
--------	--

Plenum Cable Solution	Non-Plenum Cable Solution	Description
-----------------------	---------------------------	-------------

High-Grade Line Level Audio (Color Code Chart A)

SSS222P	SSS222R	22 (7x30) AWG BC 1 Pr, Foil Shield, PVC Natural CMP/Gray CMR
SSS202P	SSS202R	20 (7x28) AWG BC 1 Pr, Foil Shield, PVC Natural CMP/Gray CMR

Premium Line Level Audio (Color Code Chart B)

7240IEZ	24 (7x32) AWG TC 1 Pr, Foil Shield, PVC Multiple Colors CM
61801HS	22 (7x30) AWG TC 1 Pr, Foil Shield, PVC White CMP/Multiple Colors CMR

Line Level Audio Snake (Color Code Chart B)

GA72402GFC	24 (7x32) AWG TC 2 Pr, Ind Shielded, TPE Black CM
GA72404GFC	24 (7x32) AWG TC 4 Pr, Ind Shielded, TPE Black CM
GA72408GFC	24 (7x32) AWG TC 8 Pr, Ind Shielded, TPE Black CM
GA72412GFC	24 (7x32) AWG TC 12 Pr, Ind Shielded, TPE Black CM
GA72416GFC	24 (7x32) AWG TC 16 Pr, Ind Shielded, TPE Black CM
GA72426GFC	24 (7x32) AWG TC 26 Pr, Ind Shielded, TPE Black CM
GA72432GFC	24 (7x32) AWG TC 32 Pr, Ind Shielded, TPE Black CM
GA61802GFC	22 (7x30) AWG TC 2 Pr, Ind Shielded, TPE Blue CMR
6604HS	GA61804GFC 22 (7x30) AWG TC 4 Pr, Ind Shielded, PVC White CMP/TPE Blue CMR
6606HS	GA61806GFC 22 (7x30) AWG TC 6 Pr, Ind Shielded, PVC White CMP/TPE Blue CMR
6608HS	GA61808GFC 22 (7x30) AWG TC 8 Pr, Ind Shielded, PVC White CMP/TPE Blue CMR
6612HS	GA61812GFC 22 (7x30) AWG TC 12 Pr, Ind Shielded, PVC White CMP/TPE Blue CMR
	GA61816GFC 22 (7x30) AWG TC 16 Pr, Ind Shielded, TPE Blue CMR
	GA61820GFC 22 (7x30) AWG TC 20 Pr, Ind Shielded, TPE Blue CMR
	GA61826GFC 22 (7x30) AWG TC 26 Pr, Ind Shielded, TPE Blue CMR
	GA61832GFC 22 (7x30) AWG TC 32 Pr, Ind Shielded, TPE Blue CMR

AES EBU Digital Audio (Color Code Chart B)

DS601	26 (7x34) AWG TC 1 Pr, Foil Shield, PVC Black CM
DS601D	26 (7x34) AWG TC 2 Pr Zip, Foil Shield, PVC Black/Red Stripe CM
DS604	26 (7x34) AWG TC 4 Pr, Foil Shield, Outer Jacket TPE Black CM
DS608	26 (7x34) AWG TC 8 Pr, Foil Shield, Outer Jacket TPE Black CM
DS612	26 (7x34) AWG TC 12 Pr, Foil Shield, Outer Jacket TPE Black CM
DS616	26 (7x34) AWG TC 16 Pr, Foil Shield, Outer Jacket TPE Black CM
DS624	26 (7x34) AWG TC 24 Pr, Foil Shield, Outer Jacket TPE Black CM
DS401TS	DS401 24 (7x32) AWG TC 1 Pr, Foil Shield, PVC White CMP/Black or Violet CMR
	DS401D 24 (7x32) AWG TC 2 Pr, Zip Foil Shield, PVC Violet with Red Stripe CMR
	DS404 24 (7x32) AWG TC 4 Pr, Foil Shield, Outer Jacket TPE Violet CMR
	DS408 24 (7x32) AWG TC 8 Pr, Foil Shield, Outer Jacket TPE Violet CMR
	DS412 24 (7x32) AWG TC 12 Pr, Foil Shield, Outer Jacket TPE Violet CMR

Plenum Cable Solution	Riser Cable Solution	Description
-----------------------	----------------------	-------------

Speaker and Control Cable - Unshielded (Color Code Chart A)

SSU182P	SSU182R	18 (7x26) AWG BC 2 Cond, PVC Natural or Gray CMP/Gray CMR
SSU162P	SSU162R	16 (19x29) AWG BC 2 Cond, PVC Natural or Gray CMP/Gray CMR
SSU142P	SSU142R	14 (19x27) AWG BC 2 Cond, PVC Natural or Gray CL3P/Gray CL3R
SSU122P	SSU122R	12 (19x25) AWG BC 2 Cond, PVC Natural or Gray CL3P/Gray CL3R
SSU102P	SSU102R	10 (65x28) AWG BC 2 Cond, PVC Natural or Gray CL3P/Gray CL2R
SSU224P	SSU224R	22 (7x30) AWG BC 4 Cond, PVC Natural or Gray CMP/Gray CMR
SSU204P	SSU204R	20 (7x28) AWG BC 4 Cond, PVC Natural or Gray CMP/Gray CMR
SSU184P	SSU184R	18 (7x26) AWG BC 4 Cond, PVC Natural or Gray CMP/Gray CMR
SSU164P	SSU164R	16 (19x29) AWG BC 4 Cond, PVC Natural or Gray CMP/Gray CMR
SSU144P	SSU144R	14 (19x27) AWG BC 4 Cond, PVC Natural or Gray CL3P/Gray CL3R
SSU124P	SSU124R	12 (19x25) AWG BC 4 Cond, PVC Natural or Gray CL3P/Gray CL3R
SSU226P	SSU226R	22 (7x30) AWG BC 6 Cond, PVC Natural or Gray CMP/Gray CMR

Speaker and Control Cable - Shielded (Color Code Chart A)

SSS182P	SSS182R	18 (7x26) AWG BC 2 Cond, Foil Shield, PVC Natural or Gray CMP/Gray CMR
SSS162P	SSS162R	16 (19x29) AWG BC 2 Cond, Foil Shield, PVC Natural or Gray CMP/Gray CMR
SSS142P	SSS142R	14 (19x27) AWG BC 2 Cond, Foil Shield, PVC Nat or Gray CL3P/Gray CL3R
SSS122P	SSS122R	12 (19x25) AWG BC 2 Cond, Foil Shield, PVC Nat or Gray CL3P/Gray CL3R
SSS224P	SSS224R	22 (7x30) AWG BC 4 Cond, Foil Shield, PVC Natural or Gray CMP/Gray CMR
SSS204P	SSS204R	20 (7x28) AWG BC 4 Cond, Foil Shield, PVC Natural or Gray CMP/Gray CMR
SSS184P	SSS184R	18 (7x26) AWG BC 4 Cond, Foil Shield, PVC Natural or Gray CMP/Gray CMR
SSS164P	SSS164R	16 (19x29) AWG BC 4 Cond, Foil Shield, PVC Natural or Gray CMP/Gray CMR
SSS144P	SSS144R	14 (19x27) AWG BC 4 Cond, Foil Shield, PVC Nat or Gray CL3P/Gray CL3R
SSS124P	SSS124R	12 (19x27) AWG BC 4 Cond, Foil Shield, PVC Nat or Gray CL3P/Gray CL3R
SSS226P	SSS226R	22 (7x30) AWG BC 6 Cond, Foil Shield, PVC Natural or Gray CMP/Gray CMR

Cable Solution	Description
----------------	-------------

Speaker Cable - Unshielded Indoor/Outdoor Direct Burial - OFC (Color Code Chart A)

SSPUB162	16 (65x34) AWG OFC BC 2 Cond, PVC White or Black CM/CL3/PLTC
SSPUB142	14 (105x34) AWG OFC BC 2 Cond, PVC White, Violet or Black CL3/PLTC
SSPUB164	16 (65x34) AWG OFC BC 4 Cond, PVC Teal CM/CL3/PLTC
SSPUB144	14 (105x34) AWG OFC BC 4 Cond, PVC Blue CL3/PLTC

Speaker Cable - Unshielded Indoor/Outdoor Direct Burial (Color Code Chart A)

SSUB162	16 (65x34) AWG BC 2 Cond, PVC White or Black CM/CL3
SSUB142	14 (41x30) AWG BC 2 Cond, PVC White or Black CL3
SSUB122	12 (105x32) AWG BC 2 Cond, PVC White or Black CL3
SSUB164	16 (65x34) AWG BC 4 Cond, PVC White or Black CL3
SSUB144	14 (41x30) AWG BC 4 Cond, PVC White or Black CL3
SSUB124	12 (105x32) AWG BC 4 Cond, PVC White or Black CL3

Cable Solution	Description
----------------	-------------

Speaker Cable - High Definition - OFC (Color Code Chart B)

GSC1220FC*	12 (259x36) AWG OFC BC, Zip, PVC Transparent (*Not UL Rated. Not for use within walls.)
GSC1020FC*	10 (423x36) AWG OFC BC, Zip, PVC Transparent (*Not UL Rated. Not for use within walls.)

Automation & Lighting Control Cable

The cabling backbone of any automation and lighting control system must meet an exceptionally high performance level to ensure that the system operates reliably and at full data rates. Produced in a variety of specialized and general purpose designs, Gepco® Brand automation and lighting control cables deliver solutions for a multitude of cross-platform and manufacturer-specific standards and systems. As with all other Gepco Brand cables, each cable is a leading-edge design and features comprehensive quality verification to deliver the foundation and bandwidth for commercial automation and control system integration.

Plenum Cable Solution	Non-Plenum Cable Solution	Description
-----------------------	---------------------------	-------------

Digital Media Cables

CT504/SDMP	CT504/SDM	Multimedia Cat 5e Cable for Use with Crestron® Systems - 24 AWG BC 4 Pr, Foil Shield, PVC Blue, White or Black CMP/PVC Blue, White or Black CMR
CT104/SDMP	CT104/SDM	Multimedia Cat 6A Cable for Use with Crestron® Systems - 23 AWG BC 4 Pr, Foil Shield, PVC Blue, White or Black CMP/PVC Blue, White or Black CMR

Automation Control Cables

18/22AXLP	18/22AXL	For Use with AMX® Systems - 22 (7x30) AWG BC 1 Pr, Foil Shield +18 (7x26) AWG BC 1 Pr, Unshielded, PVC Black CMP/Black CL3R/FT-4
18/22CRTP	18/22CRT	For Use with Crestron® Systems - 22 (7x30) AWG BC 1 Pr, Foil Shield +18 (7x26) AWG BC 1Pr, Unshielded, PVC Blue with Yellow Stripe CMP/CL3R,FT-4
	18/22CCT	Hybrid Cables for Use with Crestron® Systems - 1 18/22CRT + 1 Cat 5e, PVC Teal with Red Stripe CL3/FT-4
	18/22CCD	Hybrid Cables for Use with Crestron® Systems - 1 18/22CRT + 2 Cat 5e, PVC Teal with Black Stripe CL3/FT-4
	18/22CCQ	Hybrid Cables for Use with Crestron® Systems - 1 18/22CRT + 4 Cat 5e, PVC Teal with White Stripe CL3/FT-4
	18/22CDC	Hybrid Cables for Use with Crestron® Systems - 1 18/22CRT + 2 Cat 5e + 2 RG 6 Quad Coax, PVC Teal with Orange Stripe CL3/FT-4
	164NCAT	Keypad Volume Control - 16 (65x34) AWG BC 4 Cond + 1 Cat 5e, PVC Teal with Gray Stripe CM/CL3
	144NCAT	Keypad Volume Control - 14 AWG (105x34) BC 4 Cond + 1 Cat 5e, PVC Blue with Gray Stripe CM/CL3

Lighting Control Cables

	164LTCH	Control Station Cable for Use with LiteTouch® Systems - 16 (65x34) AWG BC 4 Cond, PVC Orange CL3/PLTC
	224SLTCH	Enclosure & Module Cable for Use with LiteTouch® Systems - 22 (7x30) AWG BC 4 Cond, Foil Shield, PVC Green CM/CL3
	182LUTDS	Power Cable for Use with Lutron® Homeworks® Systems - 18 (7x26) AWG BC 2 Cond, Foil Shield, PVC Blue with Pink Stripe TC
	184LUTDS	Power Cable for Use with Lutron® Homeworks® Systems - 18 (7x26) AWG BC 4 Cond, Foil Shield, PVC Blue with White Stripe TC
	18/22KYPP	Keypad Cable for Use with Lutron® Homeworks® Systems - 22 (7x30) AWG BC 1 Pr, Foil Shield + 18 (16x30) AWG BC 1 Pr, PVC Blue with Yellow Stripe CM/CL3
	12/22LGRX	Control Cable for Use with Lutron® GRAFIK Eye® Systems - 22 (7x30) AWG BC 1 Pr, Foil Shield +12 (19x25) AWG BC 1 Pr +Ground, PVC Blue with Blue Stripe CM/CL3
	18/22GFE	Control Cable for Use with Lutron® GRAFIK Eye® Systems - 22 (7x30) AWG BC 1 Pr, Foil Shield + 18 (16x30) AWG BC 1 Pr, PVC Blue with Green Stripe CM/CL3
	16/18SVA	Hybrid Cable for Use with Lutron® Sivoia® Systems - 18 (16x30) AWG BC 4 Cond, Foil Shield +16 (26x30) AWG BC 2 Cond +Ground, PVC Blue with Red Stripe CM/CL3
	16/18SVAP	Hybrid Cable for Use with Lutron® Sivoia® Systems - 18 (16x30) AWG BC 4 Cond, Foil Shield +16 (26x30) AWG BC 2 Cond +Ground, PVC Natural with Red Stripe CL3P/CMP
	162VANT65	Power & Data Cable for Use with Vantage® Systems - 16 (65x34) AWG BC 2 Cond, PVC Violet with Yellow Stripe CL3/CM/TC

DMX Lighting Control Cables

	DLC124	DMX Lighting Control - 24 (7x32) AWG TC 1 Pr, Foil, 90% TC Braid, TPE Black
	DLC224	DMX512 Lighting Control - 24 (7x32) AWG TC 2 Pr, Foil, 90% TC Braid, TPE Black
	DLC122	DMX Lighting Control - 22 (7x30) AWG TC 1 Pr, Foil, 90% TC Braid, PU Black
	DLC222	DMX512 Lighting Control - 22 (7x30) AWG TC 2 Pr, Foil, 90% TC Braid, PU Black

AMX® is a registered trademark of AMX LLC. • Crestron® is a registered trademark of Crestron Electronics, Inc. • LiteTouch® is a registered trademark of LiteTouch, Inc. • Lutron® is a registered trademark of Lutron Electronics Co., Inc. • Homeworks® is a registered trademark of Lutron Electronics Co., Inc. • GRAFIK Eye® is a registered trademark of Lutron Electronics Co., Inc. • Sivoia® is a registered trademark of Lutron Electronics Co., Inc. • Vantage® is a registered trademark of Legrand Home Systems, Inc.

Special constructions and technical data sheets available by request.

Put-Ups and Jacket Color Codes

Example: SAPS124.XX.YY (XX= Put Up and YY=Jacket Color)

Put-Up Codes		Jacket Color Code A		Jacket Color Code B	
25	500 Ft. Pull Pac	01	Black	0	Black
30	1000 Ft. Pull Pac	02	White	1	Brown
38	500 Ft. Reel	06	Green	2	Red
41	1000 Ft. Reel	14	Blue	3	Orange
99	Bulk	19	Violet	4	Yellow
		86	Natural	5	Green
		B9	Teal	6	Blue
				7	Violet
				8	Gray
				9	White

*Put-up and jacket color code options vary by part number.

**Refer to Cable Chart Headers to determine Color Code A, B or none.

Powered Cable

Through research and technology, Gepco provides a portable, all-in-one solution for applications requiring audio or data along with power while protecting the signal from noise. Gepco® Brand RunONE™ Powered Cables combine audio and power, along with optional data, under a single durable, yet flexible jacket. Saving time and hassle by allowing the user to replace multiple cables with a single, neat solution, each RunONE cable combines power with two, eight or 12 channels of 110 Ω balanced audio for line level, mic level or digital AES signals and can be used for self-powered speakers, staging applications and DMX lighting control.



Cable Solution	Description
Powered Cable - Bulk	
PA2	14 (41x30) AWG BC Power + 2 Pr 24 (7x32) AWG TC AES/EBU Audio, PVC Black AWM 2464
PA8	14 (41x30) AWG BC Power + 8 Pr 24 (7x32) AWG TC AES/EBU Audio, PVC Black AWM 2464
PA12	14 (41x30) AWG BC Power + 12 Pr 24 (7x32) AWG TC AES/EBU Audio, PVC Black AWM 2464
PA2C	14 (41x30) AWG BC Power + 2 Pr 24 (7x32) AWG TC AES/EBU Audio + 2 Cat 5e, PVC Black AWM 2464
PA12C	14 (41x30) AWG BC Power + 12 Pr 24 (7x32) AWG TC AES/EBU Audio + 2 Cat 5e, PVC Black AWM 2464
PA2T	12 (105x32) AWG BC Power + 2 Pr 24 (7x32) AWG TC AES/EBU Audio, PVC Black AWM 2464
Powered Cable - Assemblies	
PA01###EMIF	NEMA 5-15 Plug with 1 Male XLR to IEC with 1 Female XLR - (14 AWG Power)
PA02###EMPF	NEMA 5-15 Plug with 2 Male XLRs to Neutrik® powerCON® with 2 Female XLRs - (14 AWG Power)
PA08###EMEF	NEMA 5-15 Plug with 8 Male XLR's to NEMA 5-15 Connector with 8 Female XLRs - (14 AWG Power)
C08###EMREFR	NEMA 5-15 Plug with 2 Male XLRs and 2 RJ45s to NEMA 5-15 Connector with 2 Female XLRs and 2 RJ45s - (14 AWG Power)
T02###EMFIFM	NEMA 5-15 Plug with 1 Male & 1 Female XLR to IEC with 1 Female & 1 Male XLR - (12 AWG Power)

- indicates length in feet. Other assembly configurations available upon request.

CAROL BRAND

In addition to the full Gepco® Brand commercial A/V wire and cable solutions, General Cable also provides a complementary line of **Carol® Brand Portable Power and Control Cable Solutions** manufactured for use in the Entertainment industry. They are designed to deliver temporary power to television and theater sets, mobile broadcast trucks, concerts, sporting events and other sites with the lowest possible electrical loss and failures.

Carol Brand power cord and lighting cables are flexible, durable and suitable for both indoor and outdoor use. Our cables are RoHS Compliant, meet UL requirements and are in compliance with the National Electrical Code® (NEC).

The Carol Brand offering includes:

- Carol Brand Super Vu-Tron® Entertainment & Stage Lighting Cable 105°C 600 Volt, UL Type SC and CSA Type PPC
- Carol Brand Super Vu-Tron Single Conductor Type W Extra-Flex Cable 90°C 2000 Volt, UL and CSA Type W
- Carol Brand Super Vu-Tron Supreme Types SJ00W/S00W Cord 105°C 300 and 600 Volt, UL/CSA Portable Cord
- Carol Brand Carolprene® Types SJ00W/S00W Cord 90°C 600 Volt, UL/CSA Portable Cord
- Carol Brand Lighting Cables for Socapex* Connector Applications 105°C 600 Volt, 12 and 14 AWG, 14 or 19 Conductor, UL and CSA AWM
- Carol Brand HMI Lighting Cables

When you require the reliable power to deliver superior signals, lighting and sound, **Demand Better and Expect More** with the broadest line of General Cable Carol Brand portable power and control cable solutions available.

National Electrical Code® and NEC® are registered trademarks of the NFPA. *Socapex is a trademark of Amphenol Corporation.



LEADING-EDGE DESIGNS

Manufactured to industry-leading specifications, Gepco Brand products provides the bandwidth and precision for both current and future signal transmission formats.

100% TESTED AND VERIFIED

Every lot is comprehensively tested and verified to ensure consistent performance and reliability.

LEAN SIX SIGMA

General Cable applies the Lean Six Sigma management philosophy, seeking innovative ways to differentiate our Gepco Brand products and services and to serve as our customers' and suppliers' most valued business partner. Lean focuses on the continuous process of identifying and eliminating waste and non-value-added activities to improve the flow of information and materials and maximizing quality and service to the customer while improving overall value.



PROFESSIONAL CABLING TECHNOLOGY

The Gepco Brand Commercial A/V line is produced with the same manufacturing technologies used to make professional broadcast and studio cabling products.

INSTALLER-FRIENDLY FEATURES

Features such as easy-strip compounds, low-friction jackets, color coding, and versatile packaging simplify cable termination and installation. In addition, General Cable's TRU-Mark® Marking System sequentially marks every two feet of cable in both ascending and descending order from the start of the reel to the core.

ISO CERTIFIED

General Cable manufacturing facilities are certified to the ISO 9001:2008 quality standard. This standard assures that formalized processes are being implemented to ensure efficiency, quality and continuous improvement.

Speaker Wire

UL Listed

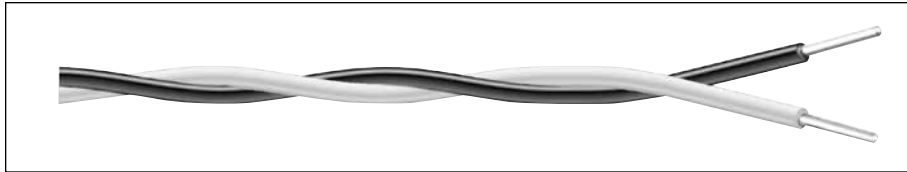

CATALOG NUMBER	NO. OF COND.	AWG SIZE	COND. STRAND	NOM. INSULATION THICKNESS		NOMINAL O.D.	
				INCHES	mm	INCHES	mm
AWM STYLE 1007 (80°C, 300 V)							
C7102A	2	18	7/.0152	0.020	0.51	0.172	4.37

Data subject to change.

Color Code Chart

ORDERING SUFFIX	STOCK COLOR
99	Black-White

Product Construction:

Conductor:

- 18 AWG tinned annealed stranded copper
- Stranded tinned copper per ASTM B33

Insulation:

- Premium-grade, color-coded PVC
- Temperature range: -30°C to +80°C
- Color code: See chart below

Applications:

- Audio systems
- Not for in-wall use

Compliances:

- UL Style 1007 (UL: 80°C, 300 V)
- AWM Style 1007
- RoHS Compliant Directive 2011/65/EU

Packaging:

- 1000' (305 m) reels

Special Audio, Communication & Instrumentation

UL 2095, 2093

Product Construction:

Conductor:

- 24 thru 20 AWG fully annealed stranded tinned copper per ASTM B33

Insulation:

- Premium-grade, color-coded polyethylene (C1333A) or PVC (C1345A)
- Color code: See chart below

Shield:

- 100% Flexfoil® aluminum/polyester foil with 25% overlap, minimum, foil facing out
- Stranded tinned copper drain wire

Jacket:

- PVC, gray
- Temperature range: -20°C to +80°C

Applications:

- Audio
- Communications
- EMI isolated circuits for instrumentation
- Suggested voltage rating: 300 volts

Compliances:

- UL Style 2093 (UL: 60°C, 300 V)
- UL Style 2095 (UL: 80°C, 300 V)
- RoHS Compliant Directive 2011/65/EU

Packaging:

- Please contact Customer Service for packaging and color options



CATALOG NUMBER	NO. OF COND.	AWG SIZE	COND. STRAND	NOM. INSULATION THICKNESS		NOM. JACKET THICKNESS		NOMINAL O.D.		NOM. CAP.*	
				INCHES	mm	INCHES	mm	INCHES	mm	A	B
UL Style 2093, 300 VOLT											
C1333A	3	2-20 Shielded 1-20 Unshielded	10/30	0.015	0.38	0.028	0.71	0.206	5.23	26.0	47.0
			7/28	0.016	0.41						

*A – Capacitance between conductors

*B – Capacitance between one conductor and other conductors connected to shield

Data subject to change.

Color Code Chart

NO. OF COND.	COLOR
Shielded	
1	Black
2	Red
Unshielded	
1	Natural



CATALOG NUMBER	NO. OF COND.	AWG SIZE	COND. STRAND	NOM. INSULATION THICKNESS		NOM. JACKET THICKNESS		NOMINAL O.D.		NOM. CAP.*	
				INCHES	mm	INCHES	mm	INCHES	mm	A	B
UL Style 2095, 300 VOLT											
C1345A	6	4-24 Shielded 2-22 Unshielded	7/32	0.015	0.38	0.025	0.64	0.230	5.84	32.0	57.0
			7/30								

*A – Capacitance between conductors

*B – Capacitance between one conductor and other conductors connected to shield

Data subject to change.

Color Code Chart

NO. OF COND.	COLOR
Shielded	
1	Black
2	Red
3	Green
4	Yellow
Unshielded	
1	Blue
2	White

Special Audio, Communication & Instrumentation

UL 2095, UL 2835, UL 2094, NEC Type CL2

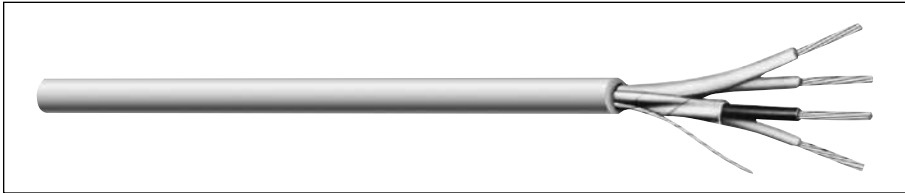

CATALOG NUMBER	NO. OF COND.	AWG SIZE	COND. STRAND	NOM. INSULATION THICKNESS		NOM. JACKET THICKNESS		NOMINAL O.D.		NOM. CAP.*	
				INCHES	mm	INCHES	mm	INCHES	mm	A	B
UL Style 2095, NEC Type CL2											
C1331A	4	2-20 Shielded 2-20 Unshielded	7/28	0.016	0.41	0.032	0.81	0.230	5.84	41.0	74.0
UL Style 2835											
C1340A	4	2-22 Shielded 2-22 Unshielded	7/30	0.008	0.20	0.017	0.43	0.161	4.09	29.0	52.0
UL Style 2094											
C1343A	4	2-20 Shielded 2-18 Unshielded	7/28 16/30	0.018	0.46	0.032	0.81	0.259	6.58	27.0	49.0

*A - Capacitance between conductors

*B - Capacitance between one conductor and other conductors connected to shield

Data subject to change.

Color Code Chart

NO. OF COND.	COLOR
Shielded	
1	Black
2	Red
Unshielded	
1	Green
2	White

Product Construction:

Conductor:

- 22 thru 18 AWG fully annealed stranded tinned copper per ASTM B33

Insulation:

- C1331A - Premium-grade, color-coded PVC
- C1340A - Premium-grade, color-coded polypropylene
- C1343A - Premium-grade, color-coded polyethylene
- Color code: See chart below

Shield:

- 100% Flexfoil® aluminum/polyester over two conductors, 25% overlap, minimum, foil facing out
- Stranded tinned copper drain wire

Jacket:

- PVC, gray
- Temperature range: -20°C to +80°C

Applications:

- Audio
- Communications
- EMI isolated circuits for instrumentation

Compliances:

- NEC Article 725 Type CL2 (UL: 75°C, 150 V)
- C1331A - UL Style 2095 (UL: 80°C)
- C1340A - UL Style 2835 (UL: 60°C)
- C1343A - UL Style 2094 (UL: 60°C)
- RoHS Compliant Directive 2011/65/EU
- Designed to meet UL 70,000 BTU Vertical Tray Flame Test

Packaging:

- Please contact Customer Service for packaging and color options



Microphone Cable, Multi-Conductor, Carolprene®

High and Low Impedance

Product Construction:

Conductor:

- 18 and 16 AWG fully annealed stranded tinned copper per ASTM B33

Insulation:

- Premium-grade, color-coded rubber
- Color code: See chart below

Shield:

- 80% braid tinned copper

Jacket:

- Carolprene®, black
- Temperature range: -20°C to +60°C

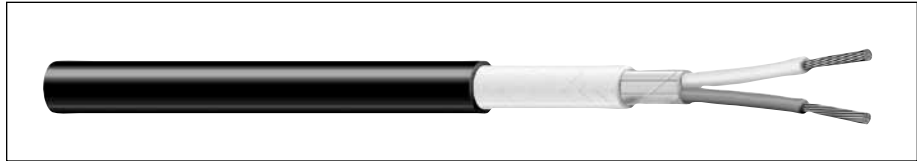

CATALOG NUMBER	NO. OF COND.	AWG SIZE	COND. STRAND	NOM. INSULATION THICKNESS		NOM. JACKET THICKNESS		NOMINAL O.D.		NOM. CAP.* pF/ft
				INCHES	mm	INCHES	mm	INCHES	mm	
C1201	1	18	41/34	0.040	1.02	0.035	0.89	0.240	6.10	46.0
C1202	2	18	41/34	0.020	0.51	0.035	0.89	0.295	7.49	61.0
C1602	2	16	65/34	0.025	0.64	0.035	0.89	0.335	8.51	55.0

*Capacitance between one conductor and other conductors connected to shield
Data subject to change.

Applications:

C1201:

- High-impedance microphones
- Broadcast and studio use
- Communication and audio systems
- Suggested voltage rating: 300 volts

C1202, C1602:

- Low-impedance microphones
- Studio use
- Control circuits
- Video and interconnecting cables
- Shielded power supplies
- Suggested voltage rating: 300 volts

Color Code Chart

NO. OF COND.	COLOR
1	White
2	Black

Features:

- Precision engineered to transmit clear, noise-free signals
- Minimizes electrical "hum"
- Resistant to oil, acid, sunlight, abrasion and aging
- Excellent noise rejection

Compliances:

- RoHS Compliant Directive 2011/65/EU

Packaging:

- Please contact Customer Service for packaging and color options

Hook-Up Wire

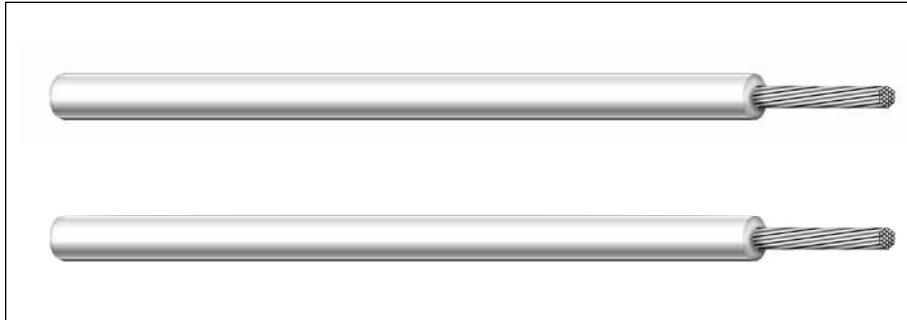

Most applications of hook-up and lead wire for board-to-board or point-to-point wiring rely on PVC-insulated designs.

General Cable’s Carol® Brand products offer both electrical and electronic designers a vast array of quality PVC hook-up wire to meet the specific technical demands of today, with “off-the-shelf” distributor inventoried products.

Hook-up wire is also available in special colors and/or stripe combinations with a minimum of lead time. In addition, General Cable offers a variety of put-ups to meet individual customer requirements.

Index	Page
UL 1007, UL 1569, CSA TR-64	167
UL 1015, CSA TEW	168
MIL-W-76B	169
UL Types MTW, TFF, AWM & CSA TEW	170
Heavy Wall UL Types MTW, AWM, NEC Type THW and CSA TEW	171
Rubber/PVC/Polyethylene	172

UL 1007, UL 1569, CSA TR-64

Product Construction:

Conductor:

- 24 thru 16 AWG
- Fully annealed tinned copper per ASTM B33
- Solid or stranded

Insulation:

- Premium-grade, color-coded PVC
- Temperature range: -20°C to +105°C
- Color code: See chart below

Applications:

- Internal wiring of electrical and electronic equipment
- Internal wiring of panels and meters
- Point-to-point wiring
- Suggested voltage rating: 300 volts

Compliances:

- UL Style 1569 (UL: 105°C, 300 V)
- CSA TR-64: 90°C, 300 V
- RoHS Compliant Directive 2011/65/EU
- Designed to meet UL VW-1 Vertical Wire Flame Test

Packaging:

- Please contact Customer Service for packaging and color options

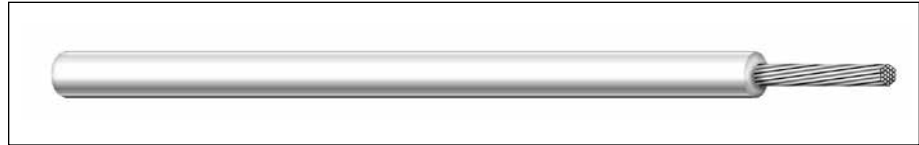

CATALOG NUMBER	AWG SIZE	COND. STRAND	NOM. INSULATION THICKNESS		NOMINAL O.D.	
			INCHES	mm	INCHES	mm

SOLID CONDUCTORS

C2003A	24	Solid	0.016	0.41	0.052	1.32
C2004A	22	Solid	0.016	0.41	0.057	1.45
C2028A	20	Solid	0.016	0.41	0.064	1.63
C2052A	18	Solid	0.016	0.41	0.072	1.83
C2053A	16	Solid	0.016	0.41	0.083	2.11

STRANDED CONDUCTORS

C2015A	24	7/32	0.016	0.41	0.056	1.42
C2016A	22	7/30	0.016	0.41	0.062	1.57
C2040A	20	10/30	0.016	0.41	0.070	1.78
C2064A	18	16/30	0.016	0.41	0.080	2.03
C2065A	16	26/30	0.016	0.41	0.092	2.34

Data subject to change.

Color Code Chart

ORDERING SUFFIX	COLORS	ORDERING SUFFIX	COLORS
01	Black	06	Green
02	White	07	Blue
03	Red	08	Brown
04	Orange	10	Gray
05	Yellow	19	Purple

Striped combinations available upon request; consult Customer Service.

UL 1015, CSA TEW

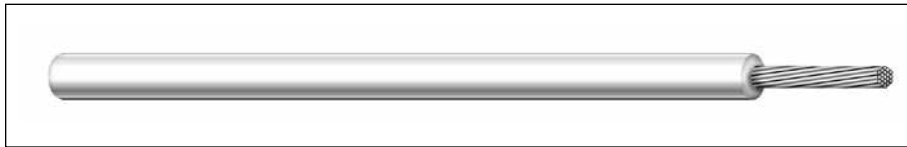

Product Construction:

Conductor:

- 24 thru 10 AWG
- Fully annealed tinned copper per ASTM B33
- Solid or stranded

Insulation:

- Premium-grade, color-coded PVC
- Temperature range: -30°C to +105°C
- Color code: See chart below

Applications:

- Internal wiring of electrical and electronic equipment
- Internal wiring of panels and meters
- Point-to-point wiring
- Suggested voltage rating: 600 volts

Compliances:

- UL Style 1015 (UL: 105°C, 600 V)
- CSA Type TEW: 105°C, 600 V
- RoHS Compliant Directive 2011/65/EU
- Designed to meet UL VW-1 Vertical Wire Flame Test

Packaging:

- Please contact Customer Service for packaging and color options

CATALOG NUMBER	AWG SIZE	COND. STRAND	NOM. INSULATION THICKNESS		NOMINAL O.D.	
			INCHES	mm	INCHES	mm

SOLID CONDUCTORS

C2117A	22	Solid	0.032	0.81	0.089	2.26
C2118A	20	Solid	0.032	0.81	0.096	2.44
C2119A	18	Solid	0.032	0.81	0.104	2.64

STRANDED CONDUCTORS

C2100A	24	7/32	0.032	0.81	0.088	2.24
C2101A	22	7/30	0.032	0.81	0.094	2.39
C2102A	20	10/30	0.032	0.81	0.102	2.59
C2103A	18	16/30	0.032	0.81	0.112	2.84
C2104A	16	26/30	0.032	0.81	0.124	3.15
C2105A	14	41/30	0.032	0.81	0.141	3.58
C2106A	12	65/30	0.032	0.81	0.160	4.06
C2107A	10	105/30	0.033	0.84	0.184	4.67

Data subject to change.

Color Code Chart

ORDERING SUFFIX	COLORS	ORDERING SUFFIX	COLORS
01	Black	06	Green
02	White	07	Blue
03	Red	08	Brown
04	Orange	10	Gray
05	Yellow	19	Purple

Striped combinations available upon request; consult Customer Service.



MIL-W-76B

Type MW

Product Construction:

Conductor:

- 24 thru 12 AWG
- Fully annealed stranded tinned copper per ASTM B33

Insulation:

- Premium-grade, color-coded PVC
- Type MW: Medium wall
- Temperature range: -12°C to +90°C
- Color code: See chart below

Applications:

- Internal wiring of electrical and electronic equipment
- Internal wiring of panels and meters
- Point-to-point wiring
- Suggested voltage rating: 1000 volts (MIL-W-76B)
- Non QPL

Compliances:

- RoHS Compliant Directive 2011/65/EU

Packaging:

- Please contact Customer Service for packaging and color options

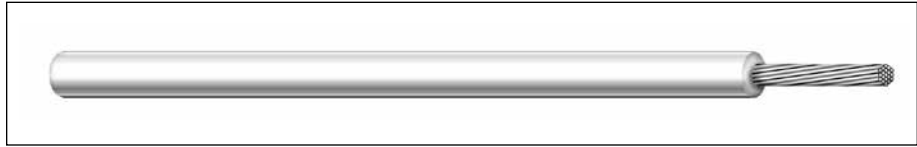

CATALOG NUMBER	TYPE DESIGNATION	AWG SIZE	COND. STRAND	NOM. INSULATION THICKNESS		NOMINAL O.D.	
				INCHES	mm	INCHES	mm
MIL-W-76B TYPE MW (MEDIUM WALL)							
C7600A	MW-C24(7)U	24	7/32	0.016	0.41	0.056	1.42
C7602A	MW-C22(7)U	22	7/30	0.016	0.41	0.062	1.57
C7604A	MW-C20(10)U	20	10/30	0.016	0.41	0.070	1.78
C7606A	MW-C18(16)U	18	16/30	0.016	0.41	0.080	2.03
C7608A*	MW-C16(26)U	16	26/30	0.016	0.41	0.092	2.34
C7610A*	MW-C14(41)U	14	41/30	0.016	0.41	0.109	2.77
C7611A*	MW-C12(65)U	12	65/30	0.016	0.41	0.128	3.25

*-25°C to +105°C

Data subject to change.

Color Code Chart

ORDERING SUFFIX	COLORS	ORDERING SUFFIX	COLORS
01	Black	06	Green
02	White	07	Blue
03	Red	08	Brown
04	Orange	10	Gray
05	Yellow	19	Purple

Striped combinations available upon request; consult Customer Service.

UL Types MTW, TFF, AWM & CSA TEW

90°C 600 Volt MTW, TFF 105°C 600 Volt AWM/TEW

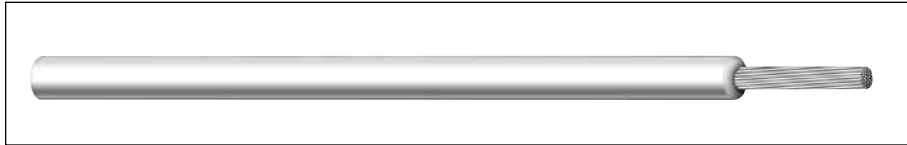

CATALOG NUMBER	AWG SIZE	COND. STRAND	NOM. INSULATION THICKNESS		NOMINAL O.D.		STOCK COLORS	APPROX. NET WEIGHT LBS/M ⁽⁹⁾
			INCHES	mm	INCHES	mm		
UL TYPE MTW, AWM, TFF, CSA TYPE TEW-600 VOLT								
76502	18	16/30	0.032	0.81	0.110	2.79	1-12	10
76512	16	26/30	0.032	0.81	0.123	3.12	1-12	14
76812	14	19/.0159	0.032	0.81	0.136	3.40	1-12	20
76822	12	19/.0185	0.032	0.81	0.155	3.91	1-7	28
76832	10	19/.0234	0.032	0.81	0.179	4.55	1-5	42
76843	8	19/.0295	0.047	1.19	0.242	6.15	1-5	72

⁽⁹⁾ Actual shipping weight may vary.
Data subject to change.

Color Code Chart

ORDERING SUFFIX	COLORS	ORDERING SUFFIX	COLORS
01	Black	04	Orange
02	White	08	Brown
03	Red	19	Purple
07	Blue	10	Gray
06	Green	13	Pink

Product Construction:

Conductor:

- 18 through 8 AWG fully annealed stranded bare copper per ASTM B8

Insulation:

- Premium-grade, color-coded PVC
- Temperature range:
MTW: -40°C to +90°C
AWM: -40°C to +105°C
TEW: -30°C to +105°C
- Color code: See chart below

Jacket Marking:

- 18 and 16 AWG:
CAROL (SIZE) 600 V E# MTW (UL) OR TFF OR 1000 V AWM VW-1 --- CSA TEW 105°C FT1 ROHS MADE IN USA
- 14 through 8 AWG:
CAROL (SIZE) 600 V E# MTW (UL) OR 1000 V AWM VW-1 --- CSA TEW 105°C FT1 ROHS MADE IN USA

Applications:

- Motor and transformer lead
- External wiring of machinery
- Internal wiring of electrical and electronic equipment
- Internal wiring of panels and meters
- Point-to-point wiring

Features:

- Outstanding oil, flame and moisture resistance
- Extra flexible

Compliances:

- UL and NMTBA Type MTW/AWM
- CSA TEW
- RoHS Compliant Directive 2011/65/EU
- Passes VW-1 Vertical Flame Test
- AWM Style 1015 – 18-8 AWG
- AWM Style 1335 – 18-10 AWG
- AWM Style 1336 – 8 AWG
- UL 1032 1000 V

Packaging:

- Please contact Customer Service for packaging and color options



Underwriters Laboratories Inc.



Heavy Wall UL Types MTW, AWM, NEC Type THW and CSA TEW 90°C 600 Volts

Product Construction:

Conductor:

- 6 and 4 AWG fully annealed stranded bare copper per ASTM B8

Insulation:

- Premium-grade, color-coded PVC, black
- Temperature range:
MTW: -40°C to +90°C
AWM: -40°C to +105°C
TEW: -30°C to +105°C

Jacket Marking:

- CAROL (SIZE) 600 V E# MTW OR THW (UL) OR 1000 V AWM VW-1 --- CSA TEW 105°C FT1 ROHS MADE IN USA

Applications:

- Motor and transformer lead
- External wiring of machinery

Features:

- Outstanding oil, flame and moisture resistance
- Extra flexible

Compliances:

- UL Type AWM
- UL and NMTBA Type MTW
- NEC Type THW
- CSA TEW
- RoHS Compliant Directive 2011/65/EU
- Passes UL VW-1 Vertical Flame Test

Packaging:

- Please contact Customer Service for packaging and color options

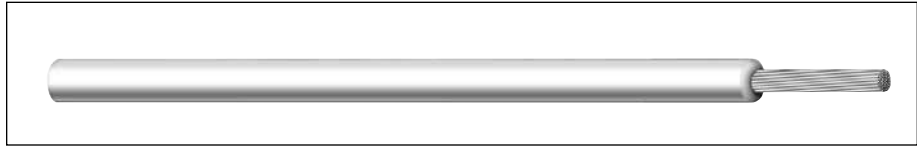

CATALOG NUMBER	AWG SIZE	COND. STRAND	NOM. INSULATION THICKNESS		NOMINAL O.D.		APPROX. NET WEIGHT LBS/m ^(S)
			INCHES	mm	INCHES	mm	
AWM, MTW, THW – 600 VOLT – UL							
76954	6	19/.0372	0.064	1.63	0.315	8.00	110
76994	4	19/.0469	0.065	1.65	0.365	9.27	150

^(S)Actual shipping weight may vary.
Data subject to change.

Rubber/PVC/Polyethylene

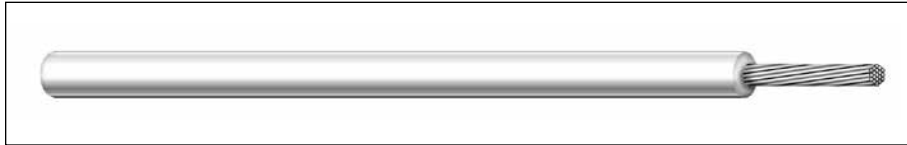

CATALOG NUMBER	NO. OF COND.	AWG SIZE	COND. STRAND	NOM. INSULATION THICKNESS		BREAKDOWN VOLTAGE (AC, rms)	WORKING VOLTAGE*	NOMINAL O.D.	
				INCHES	mm			INCHES	mm

RUBBER TEST LEAD

C1326	1	20	41/36	0.040	1.02	6,000V	1,500V	0.125	3.18
C1319	1	20	41/36	0.047	1.19	12,000V	3,000V	0.140	3.56
C1321	1	18	65/36	0.045	1.14	20,000V	5,000V	0.145	3.68
C1318	1	18	65/36	0.088	2.24	29,000V	10,000V	0.230	5.84

PVC TEST LEAD

C1320A	1	18	65/36	0.047	1.19	20,000V	5,000V	0.140	3.56
---------------	---	----	-------	-------	------	---------	--------	-------	------

POLYETHYLENE TEST LEAD

C7108A	1	14	105/34	0.032	0.81	4,000V	600V	0.140	3.56
---------------	---	----	--------	-------	------	--------	------	-------	------

*For intermittent duty only.
Data subject to change.

Color Code Chart

ORDERING SUFFIX	COLORS
01	Black
03	Red
06	Green

Product Construction:

Conductor:

- 20, 18 and 14 AWG fully annealed stranded tinned copper per ASTM B33

Insulation:

- Premium-grade, color-coded rubber, PVC or polyethylene
- Temperature range:
 - 40°C to +90°C rubber
 - 30°C to +105°C PVC
 - 60°C to +80°C polyethylene
- Color code: See chart below

Applications:

- Test equipment
- Oscilloscopes

Compliances:

- RoHS Compliant Directive 2011/65/EU

Packaging:

- Please contact Customer Service for packaging and color options

As technology becomes more complex, specifying wire and cable products to meet system performance demands becomes more time-consuming and complex.

Today's system designer must be aware not only of the general transmission line types, but also of the myriad of materials available to meet specific environmental or electrical performance criteria.

This technical section is presented to aid in the selection of materials and designs which will best suit the combination of hardware and transmission media.

For technical questions regarding specific transmission designs or applications, please contact General Cable's Engineering Department.

Index	Page
Insulation & Jacket Properties	174
Decimal Conversion Factors	175
Unit Conversion Factors	176
Temperature Conversion Chart	177
Conduit Capacity Chart	178
AWG Conductor Chart	179
Glossary	180-190
Abbreviations & Acronyms	191-193
Product Finders – Hook-Up Wire	194
Multi-Conductor Cable	195-197
Multi-Paired Cable	198-200
NEC/CEC Substitution Chart	201-202
Agency Symbols	203
Put-Ups and Color Codes	204
Catalog Number Index	205-212

Insulation & Jacket Properties

TYPICAL PROPERTIES OF COMMON INSULATING MATERIALS

PARAMETER	PVC	PE	PP	XLPE	NYLON	FEP	TFE	BUTYL RUBBER	SILICONE RUBBER	TPR
Specific Gravity	1.37	0.92	0.89	0.93-1.18	1.09	2.16	2.17	1.40	1.24	1.16-1.20
Dielectric Constant (a) 60 Hz (b) 1000 Hz	6.0 5.0	2.26 2.26	2.6	3.0 3.0	4.6 4.5	2.15 2.15	2.1 2.1	4.1 4.0	3.3 3.1	2.8 2.8
Dielectric Strength, v/mil (a) 0.010" wall (b) 0.040" wall	1800 800	2100 1050	850 450	- 700	1000 470	2000 950	2000 950	700 500	600 400	625
Tensile Strength, PSI x 1000	1.5-3.8	1.4-2.4	2.9-4.5	1.8-2.5	8.8-11.9	2.3-3.1	2.0-6.0	0.5-1.5	0.6-1.2	2.3
Service Temp, Range, °C	-55/+105	-90/+90	-40/+105	-80/+75	-55/+105	-90/+200	-90/+260	-40/+90	-80/+200	-55/+90
Elongation, %	200-375	350-550	700	250-400	150-380	200-330	200-500	200-400	125-400	500
Water Absorption, % in 24 hr	<0.75	<0.02	<0.02	<0.01	2.5	<0.01	<0.01	<1.0	<1.0	<0.6
Flame Resistance	Self Extinguishing	Supports Flame	Supports Flame	Slow Flame	Self Extinguishing	Non-Flammable	Non-Flammable	Slow Burning	Slow (Non-Cond. Ash)	Flammable
Ozone Resistance	Excellent	Good	Excellent	Good	Good	Excellent	Excellent	Excellent	Excellent	Excellent
Flexibility	Good	Good	Good	Good-Fair	Good-Fair	Good	Good	Excellent	Excellent	Excellent
Abrasion Resistance	Good	Good	Fair	Excellent	Excellent	Excellent	Excellent	Poor	Poor	Good-Fair
Acid Resistance	Excellent	Excellent	Excellent	Excellent	Excellent	Poor	Excellent	Excellent	Good	Excellent
Base Resistance	Excellent	Excellent	Excellent	Excellent	Excellent	Excellent	Excellent	Good	Good	Excellent
Hydraulic Fluid Resistance	Good-Fair	Fair-Poor	Fair	Good-Fair	Good-Fair	Excellent	Excellent	Poor	Fair-Poor	Poor
Organic Solvent Resistance	Fair-Poor	Poor	Fair	Fair	Good-Fair	Excellent	Excellent	Good-Fair	Poor	Poor

NOTE: The above is representative of performance. For specific compound performance, consult Customer Service.

TYPICAL PROPERTIES OF COMMON JACKETING MATERIALS

PARAMETER	PVC	PE	NYLON	FEP	TFE	SILICONE RUBBER	NEOPRENE	POLY-URETHANE	TPR
Specific Gravity	1.37	0.92	1.09	2.16	2.17	1.24	1.52	1.3	1.16-1.20
Tensile Strength, PSI x 1000	1.5-3.8	1.4-2.4	8.8-11.9	2.3-3.1	2.0-6.0	0.6-1.2	2.5-4.0	>3.5	2.3
Elongation, %	200-375	350-550	150-380	200-330	200-500	125-400	300-500	540-700	500
Service Temp, Range, °C	-55/+105	-80/+75	-55/+105	-90/+200	-90/+200	-80/+200	-65/+90	-65/+75	-55/+90
Ozone Resistance	Excellent	Good	Good	Excellent	Excellent	Excellent	Excellent	Good	Excellent
Weatherability	Good-Fair	Excellent-Good	Fair-Poor	Excellent	Excellent	Excellent	Good	Good	Excellent
Flame Resistance	Self Extinguishing	Supports Flame	Flammable	Non-Flammable	Non-Flammable	Slow-Burn (Non-Cond. Ash)	Self Extinguishing	Slow Burn	Flammable
Flexibility	Good	Good	Good-Fair	Good	Good	Excellent	Excellent	Excellent	Excellent
Abrasion Resistance	Good	Good	Excellent	Excellent	Excellent	Poor	Excellent	Excellent	Good-Fair
Acid Resistance	Excellent	Excellent	Poor	Excellent	Excellent	Poor	Good	Fair	Excellent
Base Resistance	Excellent	Excellent	Excellent	Excellent	Excellent	Good	Good	Fair	Excellent
Hydraulic Fluid Resistance	Good-Fair	Fair-Poor	Good-Fair	Excellent	Excellent	Fair-Poor	Good	Poor	Good
Organic Solvent Resistance	Fair-Poor	Poor	Good-Fair	Excellent	Excellent	Poor	Good	Poor	Poor
Resistance to Tearing	Good	Good	Excellent	Good	Good	Fair	Good	Excellent	Good-Fair

NOTE: The above is representative of performance. For specific compound performance, consult Customer Service.

Decimal Conversion Factors

FRACTIONS, DECIMALS AND MILLIMETER CONVERSION CHART

FRACTIONS OF AN INCH						EQUIVALENTS		FRACTIONS OF AN INCH						EQUIVALENTS	
64	32	16	8	4	2	DECIMALS	mm	64	32	16	8	4	2	DECIMALS	mm
1						0.016	0.40	33						0.516	13.10
2	1					0.031	0.79	34	17					0.531	13.49
3						0.047	1.19	35						0.547	13.89
4	2	1				0.063	1.59	36	18	9				0.563	14.29
5						0.078	1.98	37						0.578	14.68
6	3					0.094	2.38	38	19					0.594	15.08
7						0.109	2.78	39						0.609	15.48
8	4	2	1			0.125	3.18	40	20	10	5			0.625	15.88
9						0.141	3.57	41						0.641	16.27
10	5					0.156	3.97	42	21					0.656	16.67
11						0.172	4.37	43						0.672	17.07
12	6	3				0.188	4.76	44	22	11				0.688	17.46
13						0.203	5.16	45						0.703	17.86
14	7					0.219	5.56	46	23					0.719	18.26
15						0.234	5.95	47						0.734	18.65
16	8	4	2	1		0.250	6.35	48	24	12	6	3		0.750	19.05
17						0.266	6.75	49						0.766	19.45
18	9					0.281	7.14	50	25					0.781	19.84
19						0.297	7.54	51						0.797	20.24
20	10	5				0.313	7.94	52	26	13				0.813	20.64
21						0.328	8.33	53						0.828	21.03
22	11					0.344	8.73	54	27					0.844	21.43
23						0.359	9.13	55						0.859	21.83
24	12	6	3			0.375	9.53	56	28	14	7			0.875	22.23
25						0.391	9.92	57						0.891	22.62
26	13					0.406	10.32	58	29					0.906	23.02
27						0.422	10.72	59						0.922	23.42
28	14	7				0.438	11.11	60	30	15				0.938	23.81
29						0.453	11.51	61						0.953	24.21
30	15					0.469	11.91	62	31					0.969	24.61
31						0.484	12.30	63						0.984	25.00
32	16	8	4	2	1	0.500	12.70	64	32	16	8	4	2	1.000	25.40

Unit Conversion Factors

CONVERSION FACTORS

UNIT	X	CONSTANT	=	UNIT
British Thermal Unit (BTU)		778.0		foot-pound (ft-lb)
British Thermal Unit (BTU)		1054.35		joules (j)
British Thermal Unit (BTU)		0.293		watt-hours (w-hr)
centimeters (cm)		0.032808		feet (ft)
centimeters (cm)		0.3937		inches (in)
centimeters (cm)		0.00001		kilometers (km)
centimeters (cm)		0.010		meters (m)
centimeters (cm)		10.0		millimeters (mm)
circular mils (cmil)		0.00064516		circular millimeters
circular mils (cmil)		0.0000007854		inches ² (in ²)
circular mils (cmil)		0.00050671		square millimeters (mm ²)
circular mils (cmil)		0.7854		mils ²
cubic centimeter (cm ³)		0.000035314		cubic foot (ft ³)
cubic centimeter (cm ³)		0.061023		cubic inch (in ³)
cubic centimeter (cm ³)		0.000001		cubic meter (m ³)
cubic centimeter (cm ³)		0.00026417		gallons (gal)
cubic foot (ft ³)		1728.0		cubic in (in ³)
cubic foot (ft ³)		28317.847		cubic centimeter (cm ³)
cubic inch (in ³)		0.00057870		cubic feet (ft ³)
cubic inch (in ³)		0.000016387		cubic meter (m ³)
cubic inch (in ³)		16.387064		cubic centimeter (cm ³)
cubic meter (m ³)		1000000.0		centimeter (cm)
cubic meter (m ³)		35.314666		cubic foot (ft ³)
cubic meter (m ³)		264.17		gallons (gal)
feet (ft)		0.00018939		miles (mi)
feet (ft)		0.333333		yards (yd)
feet (ft)		12		inches (in)
feet (ft)		0.00030480		kilometer (km)
feet (ft)		0.30480		meters (m)
feet (ft)		30.480		centimeters (cm)
feet (ft)		304.80		millimeters (mm)
feet/pound (ft/lb)		0.00067197		meters/grams (m/g)
foot-pound (ft-lb)		0.001285		British Thermal Unit (BTU)
foot-pound (ft-lb)		1.356		joules (j)
foot-pound (ft-lb)		0.1383		kilogram/meter (kg/m)

UNIT	X	CONSTANT	=	UNIT
gallons (gal)		3.785411		liters (l)
gallons (gal)		0.13368		cubic foot (ft ³)
gallons (gal)		231.0		cubic inch (in ³)
gallons (gal)		3785.411		cubic centimeter (cm ³)
grams (g)		15.432		grains
gram/centimeter ³ (gm/cm ³)		0.0361275		pounds/in ³ (lb/in ³)
horsepower (hp)		33013.26		ft-lb/min
horsepower (hp)		550.0		ft-lb/sec
horsepower (hp)		745.7		watts (w)
inch (in)		0.027178		yards (yd)
inch (in)		0.083333		feet (ft)
inch (in)		0.00002540		kilometer (km)
inch (in)		0.025400		meter (m)
inch (in)		2.54000514		centimeter (cm)
inch (in)		25.4000514		millimeter (mm)
inch (in)		1000.0		mils
joules (j)		0.000948		British Thermal Unit (BTU)
joules (j)		10 ⁷		ergs
liters (l)		61.02374		cubic inch (in ³)
meters (m)		1.093611		yard (yd)
meters (m)		3.2808333		feet (ft)
meters (m)		39.37		inch (in)
meters (m)		100.0		centimeter (cm)
miles (mi)		1760.0		yards (yd)
miles (mi)		5280.0		feet (ft)
miles (mi)		1.6093		kilometer (km)
millimeters (mm)		0.0032808		feet (ft)
millimeters (mm)		0.03937		inch (in)
millimeters (mm)		0.001		meters (m)
millimeters (mm)		0.01		centimeters (cm)
millimeters (mm)		39.3701		mils
millimeters (mm)		1000.0		microns (μ)
watts (w)		44.25		ft-lb/minute
watts (w)		0.737562		ft-lb/sec
watts (w)		0.001341		horsepower
watt-hours (w-hr)		3.414462		British Thermal Unit (BTU)

Temperature Conversion Chart

To use this chart, find your known temperature (°F) in the shaded column.

°C	°F	°C	°F	°C	°F	°C	°F	°C	°F
-45.0	-49.0	-17.2	1.0	10.6	51.0	38.3	101.0	66.1	151.0
-44.4	-48.0	-16.7	2.0	11.1	52.0	38.9	102.0	66.7	152.0
-43.9	-47.0	-16.1	3.0	11.7	53.0	39.4	103.0	67.2	153.0
-43.3	-46.0	-15.6	4.0	12.2	54.0	40.0	104.0	67.8	154.0
-42.8	-45.0	-15.0	5.0	12.8	55.0	40.6	105.0	68.3	155.0
-42.2	-44.0	-14.4	6.0	13.3	56.0	41.1	106.0	68.9	156.0
-41.7	-43.0	-13.9	7.0	13.9	57.0	41.7	107.0	69.4	157.0
-41.1	-42.0	-13.3	8.0	14.4	58.0	42.2	108.0	70.0	158.0
-40.6	-41.0	-12.8	9.0	15.0	59.0	42.8	109.0	70.6	159.0
-40.0	-40.0	-12.2	10.0	15.6	60.0	43.3	110.0	71.1	160.0
-39.4	-39.0	-11.7	11.0	16.1	61.0	43.9	111.0	71.7	161.0
-38.9	-38.0	-11.1	12.0	16.7	62.0	44.4	112.0	72.2	162.0
-38.3	-37.0	-10.6	13.0	17.2	63.0	45.0	113.0	72.8	163.0
-37.8	-36.0	-10.0	14.0	17.8	64.0	45.6	114.0	73.3	164.0
-37.2	-35.0	-9.4	15.0	18.3	65.0	46.1	115.0	73.9	165.0
-36.7	-34.0	-8.9	16.0	18.9	66.0	46.7	116.0	74.4	166.0
-36.1	-33.0	-8.3	17.0	19.4	67.0	47.2	117.0	75.0	167.0
-35.6	-32.0	-7.8	18.0	20.0	68.0	47.8	118.0	75.6	168.0
-35.0	-31.0	-7.2	19.0	20.6	69.0	48.3	119.0	76.1	169.0
-34.4	-30.0	-6.7	20.0	21.1	70.0	48.9	120.0	76.7	170.0
-33.9	-29.0	-6.1	21.0	21.7	71.0	49.4	121.0	77.2	171.0
-33.3	-28.0	-5.6	22.0	22.2	72.0	50.0	122.0	77.8	172.0
-32.8	-27.0	-5.0	23.0	22.8	73.0	50.6	123.0	78.3	173.0
-32.2	-26.0	-4.4	24.0	23.3	74.0	51.1	124.0	78.9	174.0
-31.7	-25.0	-3.9	25.0	23.9	75.0	51.7	125.0	79.4	175.0
-31.1	-24.0	-3.3	26.0	24.4	76.0	52.2	126.0	80.0	176.0
-30.6	-23.0	-2.8	27.0	25.0	77.0	52.8	127.0	80.6	177.0
-30.0	-22.0	-2.2	28.0	25.6	78.0	53.3	128.0	81.1	178.0
-29.4	-21.0	-1.7	29.0	26.1	79.0	53.9	129.0	81.7	179.0
-28.9	-20.0	-1.1	30.0	26.7	80.0	54.4	130.0	82.2	180.0
-28.3	-19.0	-0.6	31.0	27.2	81.0	55.0	131.0	82.8	181.0
-27.8	-18.0	0.0	32.0	27.8	82.0	55.6	132.0	83.3	182.0
-27.2	-17.0	0.6	33.0	28.3	83.0	56.1	133.0	83.9	183.0
-26.7	-16.0	1.1	34.0	28.9	84.0	56.7	134.0	84.4	184.0
-26.1	-15.0	1.7	35.0	29.4	85.0	57.2	135.0	85.0	185.0
-25.6	-14.0	2.2	36.0	30.0	86.0	57.8	136.0	85.6	186.0
-25.0	-13.0	2.8	37.0	30.6	87.0	58.3	137.0	86.1	187.0
-24.4	-12.0	3.3	38.0	31.1	88.0	58.9	138.0	86.7	188.0
-23.9	-11.0	3.9	39.0	31.7	89.0	59.4	139.0	87.2	189.0
-23.3	-10.0	4.4	40.0	32.2	90.0	60.0	140.0	87.8	190.0
-22.8	-9.0	5.0	41.0	32.8	91.0	60.6	141.0	88.3	191.0
-22.2	-8.0	5.6	42.0	33.3	92.0	61.1	142.0	88.9	192.0
-21.7	-7.0	6.1	43.0	33.9	93.0	61.7	143.0	89.4	193.0
-21.1	-6.0	6.7	44.0	34.4	94.0	62.2	144.0	90.0	194.0
-20.6	-5.0	7.2	45.0	35.0	95.0	62.8	145.0	90.6	195.0
-20.0	-4.0	7.8	46.0	35.6	96.0	63.3	146.0	91.1	196.0
-19.4	-3.0	8.3	47.0	36.1	97.0	63.9	147.0	91.7	197.0
-18.9	-2.0	8.9	48.0	36.7	98.0	64.4	148.0	92.2	198.0
-18.3	-1.0	9.4	49.0	37.2	99.0	65.0	149.0	92.8	199.0
-17.8	0.0	10.0	50.0	37.8	100.0	65.6	150.0	93.3	200.0

TEMPERATURE CONVERSION FORMULA

$$^{\circ}\text{C} = \frac{5}{9} (^{\circ}\text{F} - 32)$$

$$^{\circ}\text{F} = \frac{9}{5} ^{\circ}\text{C} + 32$$

Conduit Capacity Chart

Conduit Trade Size		1/2	3/4	1	1 1/4	1 1/2	2	2 1/2	3	3 1/2	4
I.D. Inches		0.622	0.824	1.049	1.380	1.610	2.067	2.731	3.356	3.834	4.334
Internal Area, In ²		0.304	0.533	0.864	1.496	2.036	3.356	5.858	8.846	11.545	14.753
1 Conductor (53% fill)		0.161	0.283	0.458	0.793	1.079	1.778	3.105	4.688	6.119	7.819
2 Conductors (31% fill)		0.094	0.165	0.268	0.464	0.631	1.040	1.816	2.742	3.579	4.573
Conductors (40% fill)		0.122	0.213	0.346	0.598	0.814	1.342	2.343	3.538	4.618	5.901
Cable OD Inches	Cable Area In ²	Numbers listed below are based on the 2008 NEC (40% fill) for 3 or more non-lead covered cables.									
0.100	0.008	15	26	43	76	104	170	244	375	504	648
0.125	0.012	9	17	27	48	66	109	156	240	322	414
0.150	0.018	6	11	19	33	46	75	108	166	224	288
0.175	0.024	5	8	14	24	34	55	79	122	164	211
0.200	0.031	3	6	10	19	26	42	81	93	126	162
0.225	0.040	3	5	8	15	20	33	48	74	99	128
0.250	0.049	1	4	6	12	16	27	39	60	80	103
0.275	0.059	1	3	5	10	13	22	32	49	66	85
0.300	0.071	1	2	4	8	11	18	27	41	56	72
0.325	0.083	1	1	4	7	9	16	23	35	47	61
0.350	0.096	1	1	3	6	8	13	19	30	41	52
0.375	0.110	1	1	3	5	7	12	17	26	35	46
0.400	0.126	1	1	2	4	6	10	15	23	31	40
0.425	0.142	1	1	1	4	5	9	13	20	27	35
0.450	0.159	1	1	1	3	5	8	12	18	24	32
0.475	0.177	0	1	1	3	4	7	10	17	22	28
0.500	0.196	0	1	1	3	4	6	9	15	20	25
0.525	0.216	0	1	1	2	3	6	8	13	18	23
0.550	0.238	0	1	1	1	3	5	8	12	16	21
0.575	0.260	0	1	1	1	3	5	7	11	15	19
0.600	0.283	0	0	1	1	2	4	6	10	14	18
0.625	0.307	0	0	1	1	2	4	6	9	12	16
0.650	0.332	0	0	1	1	1	4	5	8	11	15
0.675	0.358	0	0	1	1	1	3	5	8	11	14
0.700	0.385	0	0	1	1	1	3	5	7	10	13
0.725	0.413	0	0	1	1	1	3	4	7	9	12
0.750	0.442	0	0	1	1	1	3	4	6	8	11
0.775	0.472	0	0	0	1	1	2	4	6	8	10
0.800	0.503	0	0	0	1	1	2	3	5	7	10
0.825	0.535	0	0	0	1	1	1	3	5	7	9
0.850	0.567	0	0	0	1	1	1	3	5	6	8
0.875	0.601	0	0	0	1	1	1	3	4	6	8
0.900	0.636	0	0	0	1	1	1	3	4	6	8
0.925	0.672	0	0	0	1	1	1	2	4	5	7
0.950	0.709	0	0	0	1	1	1	2	4	5	7
0.975	0.747	0	0	0	1	1	1	1	3	5	6
1.000	0.785	0	0	0	1	1	1	1	3	5	6
1.025	0.825	0	0	0	0	1	1	1	3	4	6
1.050	0.866	0	0	0	0	1	1	1	3	4	5
1.075	0.908	0	0	0	0	1	1	1	3	4	5

Notice: 1. The reader is cautioned to consult the NEC for specific information regarding conduit fill.
 2. This Conduit Capacity Chart should only be used as a guide when attempting to estimate conduit fill.
 3. For additional information, the reader should refer to the National Electrical Code.



AWG Conductor Chart

COPPER CONDUCTOR DATA

The conductors used by General Cable meet the applicable requirements of ASTM specifications B-3, B-33, B-172, B-173, B-174 and B-286 and Federal Specification QQ-W-343.

The following data covers the more commonly used conductor constructions in the electrical and electronics industry. Special constructions, not shown, are available or can be designed to meet specific requirements. It is suggested that the General Cable Product Engineering Department be contacted before a specification is finalized.

AWG	STRANDING	TYPE STRANDING ⁽¹⁾	DIAMETER ⁽⁴⁾		AREA		WEIGHT		D.C. RESISTANCE 20°C ⁽²⁾				BREAK STR. LBS	
			in	mm	circ. mils	sq. mm	lbs/Mft	kg/km	TIN COATING ⁽³⁾		BARE OF SILVER COATING			
									Ω/Mft	Ω/km	Ω/Mft	Ω/km		
32	7/40	Co or Bu	.0096	.254	100	.051	.21	.31	176.00	577.00	164.00	538.00	1.986	
30	Solid 7/38	-	.010	.254	100	.051	.30	.45	113.00	371.00	104.00	340.00	3.157	
		Bu	.012	.305	112	.057	.35	.52	106.00	348.00	92.60	303.00		
28	Solid 7/36	-	.01264	.321	159	.081	.48	.72	70.80	232.00	65.30	214.00	5.020	
		Co	.015	.381	175	.089	.55	.82	67.50	221.00	59.30	194.00		
27	Solid 7/35	-	.0142	.361	202	.102	.61	.91	55.60	182.00	51.40	169.00	6.331	
		Co or Bu	.017	.432	220	.111	.69	1.04	53.80	176.00	-	-		
26	Solid 7/34	-	.016	.404	253	.128	.77	1.14	44.50	146.00	41.00	135.00	7.983	
		Co or Bu	.019	.483	278	.141	.87	1.29	42.50	139.00	37.30	122.00		
		Bu	.0193	.490	250	.127	.78	1.15	47.30	155.00	40.40	133.00		
		10/36	Bu or Co	.021	.533	304	.154	.97	1.44	38.90	128.00	34.10		112.00
24	Solid 7/32	-	.0201	.511	404	.205	1.22	1.82	27.20	89.20	25.70	84.20	12.690	
		Co or Bu	.024	.610	448	.227	1.38	2.05	25.70	84.20	23.10	75.90		
		Bu	.024	.610	400	.201	1.25	1.64	29.50	96.80	27.50	90.20		
		16/36	Co or Bu	.025	.635	475	.241	1.48	2.20	24.90	81.70	21.80		71.60
22	Solid 7/30	-	.025	.643	643	.324	1.94	2.89	16.70	54.80	16.20	53.20	19.430	
		Co or Bu	.030	.762	700	.355	2.19	3.26	16.60	54.40	14.80	48.60		
		Bu or Eq	.0315	.800	754	.382	2.35	3.50	15.50	50.80	13.80	45.10		
		19/34	-	.032	.813	1,020	.519	3.10	4.61	10.50	34.40	10.10		33.20
20	Solid 7/28	Co or Bu	.038	.965	1,111	.507	3.14	4.67	11.40	37.40	10.40	34.00	30.890	
		Bu	.040	1.02	1,000	.616	3.84	5.71	9.48	31.10	8.53	28.00		
		Co, Bu or Eq	.039	.940	1,216	.523	3.28	4.88	11.30	37.10	-	-		
		19/32	-	.032	.813	1,020	.519	3.10	4.61	10.50	34.40	10.10		33.20
19	Solid 7/26	-	.0403	1.024	1,290	.823	4.92	7.32	6.77	22.20	6.39	21.00	38.950	
		Co or Bu	.048	1.22	1,620	.897	5.55	8.26	6.45	21.20	5.55	19.20		
		Bu	.0475	1.207	1,770	.810	5.01	7.45	7.15	23.40	6.48	21.30		
		16/30	Co, Bu or Eq	.050	1.27	1,600	.963	5.95	8.85	6.10	20.00	5.46		17.90
18	Solid 19/30	Bu	.049	1.244	1,900	.824	5.09	7.08	7.08	23.20	6.60	21.60	49.120	
		-	.0508	1.29	1,627	1.31	7.81	11.60	4.47	14.70	4.16	13.60		
		Bu or Eq	.057	1.45	2,580	1.23	7.52	11.20	4.82	15.80	4.27	14.00		
		19/0117	Bu	.0585	1.50	2,426	1.32	8.02	11.90	4.39	14.40	4.13		13.50
16	Solid 26/30	Bu	.0606	1.54	2,601	1.32	8.15	12.10	4.39	14.40	3.99	13.10	78.100	
		Bu	.060	1.52	2,600	1.31	8.20	11.90	4.47	14.70	4.16	13.60		
		-	.0641	1.63	2,581	2.08	12.4	18.50	2.68	8.79	2.52	8.28		
		Co	.073	1.85	4,110	2.08	12.7	18.90	-	-	2.61	8.56		
14	Solid 19/27	Co, Eq or Un	.071	1.80	4,100	1.94	12.1	18.00	3.05	10.00	2.71	8.88	124.200	
		Bu	.074	1.88	3,831	2.08	12.7	18.90	2.73	-	2.61	8.56		
		Bu	.077	1.96	4,106	2.08	12.9	19.20	2.81	9.22	2.53	8.30		
		-	.0808	2.05	4,100	3.31	19.8	29.50	1.69	5.54	1.59	5.21		
12	Solid 7/0305	Bu	.092	2.34	6,530	3.30	20.2	30.10	-	-	1.64	5.38	197.500	
		Co, Eq or Un	.0905	2.299	6,512	3.08	19.4	28.90	1.87	6.13	1.70	5.59		
		Cu	.0925	2.35	6,088	3.30	20.2	30.10	-	-	1.64	5.25		
		65/30	Bu	.094	2.388	6,503	3.29	20.8	31.10	1.82	5.97	1.64		5.25
10	Solid 7/0385	-	.1019	2.588	6,500	5.26	31.4	46.80	-	-	1.00	3.28	314.500	
		Co	.116	2.95	10,380	5.25	32.0	47.60	-	-	1.00	3.28		
		Bu	.117	2.97	10,376	5.27	32.0	47.60	-	-	.98	3.21		
		19/0234	Co	.112	2.84	10,404	4.74	29.2	43.40	-	-	1.25		4.10
8	Solid 7/0486	Bu	.126	3.20	9,361	5.32	33.8	49.20	1.10	3.61	.99	3.24	197.500	
		Bu or Eq	.146	3.71	10,500	8.38	50.1	74.50	-	-	.65	2.13		
		19/0295	Bu	.144	3.66	16,534	8.38	50.0	74.40	-	-	.65		2.13
		133/29	Ro 19 x 7/29	.169	4.293	16,535	8.61	54.0	80.40	.71	2.33	-		-
6	Solid 168/30	Ro 7 x 24/30	.174	4.42	16,983	8.51	53.4	79.00	.70	2.30	-	-	314.500	
		-	.188	4.775	16,800	13.33	81.1	121.00	-	-	.40	1.30		
		Ro 19 x 7/27	.213	5.41	26,576	13.60	84.1	125.00	.43	1.41	-	-		
		266/30	Ro 7 x 38/30	.222	5.64	26,818	13.49	83.2	124.00	.44	1.44	-		-
4	Solid 133/25	Ro 19 x 7/25	.257	6.53	26,600	21.61	135.0	201.00	.29	.95	-	-	314.500	
		420/30	Ro 7 x 60/30	.270	6.850	42,615	21.29	140.0	208.00	.28	.92	-		-
2	665/30	Ro 19 x 35/30	.338	8.59	42,000	33.72	213.0	317.00	.18	.59	-	-	314.500	

(1) Bu - Bunched; Co - Concentric; Eq - Equilay; Ro - Rope; Un - Unilay
 (2) Typical DC resistance values for uninsulated wires. Multiply by 1.04 for typical values after insulation
 (3) Values are for tinned, heavy tinned, prefused, overcoated or topcoated conductors
 (4) Does not meet UL conductor stranding requirements

Glossary

- Abrasion Resistance:** Resistance to surface wear.
- AC Alternating Current (a.c.):** Current in which the charge-flow periodically reverses and is represented by: $I = I_0 \cos(2\pi f t + \phi)$ where, I is the current, I_0 is the amplitude, f the frequency, ϕ the phase angle.
- Accelerated Aging:** A test that attempts to duplicate long-time environmental aging in comparatively short time spans.
- Accelerator:** A chemical additive which hastens a chemical reaction under specific conditions.
- Accordion:** (1) A retractile cable with a series of equally-spaced transverse folds. (2) A connector contact with a "Z" shaped flat spring to permit high deflection without overstress.
- Adapter:** A device that enables any or all of the following 1) different sizes or types of plugs to mate with one another or to fit into a telecommunications outlet/connector; 2) the rearrangement of leads; 3) large cables with numerous wires to fan out into smaller groups of wires, 4) interconnection between cables.
- Adhesive Bonded:** Cables bonded by adding an adhesive coating to the surface of the cable components, then joining and curing the adhesive to form a cable. See *Bonded Cable*.
- Administration:** The method for labeling, identification, documentation and usage needed to implement moves, additions and changes of the telecommunications infrastructure.
- Admittance:** The measure of the ease with which an alternating current flows in a circuit. The reciprocal of impedance.
- Aerial Cable:** A cable suspended in the air on poles or other overhead structure.
- Aging:** The change in properties of a material with time under specific conditions.
- Air Core Cable:** A cable in which the interstices in the cable core are not filled with a moisture barrier.
- Air-Handling Plenum:** A designated area, closed or open, used for environmental air.
- Air Spaced Coaxial Cable:** One in which air is essentially the dielectric material. A spirally wound synthetic filament, beads or braided filaments may be used to center the conductor.
- All-Rubber Cable:** A cable in which all interstices between conductors are filled with rubber compound.
- Alligator Clip:** A mechanical device shaped like alligator jaws used as a temporary connection on the end of interconnections wire.
- Alloy:** A metal formed by combining two or more different metals to obtain desirable properties.
- Aluminum Conductor:** An aluminum wire or group of wires not suitably insulated to carry electrical current.
- Aluminum-Steel Conductor:** A composite conductor made up of a combination of aluminum and steel wires.
- Ambient Temperature:** The temperature of a medium (gas or liquid) surrounding an object.
- American Wire Gauge (AWG):** The standard system used for designating wire diameter. The lower the AWG number, the larger the diameter. Also called the Brown and Sharpe (B&S) wire gauges.
- Ampacity:** See *Current Carrying Capacity*.
- Ampere:** The unit of current. One ampere is the current flowing through one ohm of resistance at one volt potential.
- Analog:** A signaling format that uses continuous physical variables such as voltage amplitude or frequency variations to transmit information.
- Anneal:** Relief of mechanical stress through heat and gradual cooling. Annealing copper renders it less brittle.
- Annular Conductor:** A number of wires stranded in three reversed concentric layers around a core.
- Annunciator:** A signaling device, usually electrically operated, that gives an audible or visual signal (or both) when energized.
- Anti-Oxidant:** A substance which prevents or slows down oxidation of material exposed to air.
- Appliance Wire and Cable:** A classification covering insulated wire and cable for internal wiring of appliances and equipment.
- Arc Resistance:** The time required for an arc to establish a conductive path in a material.
- Armored Cable:** A cable provided with a wrapping of metal for mechanical protection.
- Attenuation:** The decrease in magnitude of the power of a signal in transmission between points. Attenuation is usually measured in decibels per unit length at a specific frequency.
- Attenuation to Crosstalk Ratio (ACR):** The difference between attenuation and crosstalk, measured in dB, at a given frequency. Important characteristic in networking transmission to assure that signal sent down a twisted pair is stronger at the receiving end, after being attenuated, than are any interference signals imposed on that same pair by crosstalk from other pairs, represented by NEXT.
- Audio Frequency:** The range of frequencies audible to the human ear. Usually 20-20,000 Hz.
- Backbone:** A facility (e.g. pathway, cable or conductors) between telecommunications closets or floor distribution terminals, the entrance facilities and the equipment rooms within or between buildings.
- Backbone Cable or Wire:** Cable or wire found in the backbone; see *Backbone*.
- Balanced Line:** A cable having two identical conductors which carry voltages opposite in polarity and equal in magnitude with respect to ground.
- Balun:** A device for matching an unbalanced coaxial transmission line to a balanced two-wire system.
- Band Marking:** A continuous circumferential band applied to a conductor at regular intervals for identification.
- Banded Cable:** Two or more cables banded together by stainless steel strapping.
- Bandwidth:** A continuous range of frequencies extending between two limiting frequencies. Also referred to as a frequency band.
- Barrel-Packed:** Method of coiling into a fiber drum for shipment.
- Baseband:** In data transmission, the use of a dedicated end-to-end connection to carry a single channel only.
- Beaded Coax:** Coaxial cable with a dielectric consisting of beads made of various materials.
- Belt:** Number of layers of insulation on a conductor, or number of layers of jacket on a cable.
- Belted-Type Cable:** Multiple conductor cable having a layer of insulation over the assembled insulated conductors.
- Bend Loss:** A form of increased attenuation caused by (1) having an optical fiber curved around a restrictive radius of curvature or (2) microbends caused by minute distortions in the fiber imposed by externally induced forces.
- Bend Radius:** Radius of curvature that a fiber optic or metallic cable can bend without any adverse effects.
- Bifilar:** A winding made non-inductive by winding together (as one wire) two wires carrying current in opposite directions.
- Billion Conductor Feet (BCF):** A quantity derived by multiplying the number of conductors in a cable by the amount of cable. Usually used to indicate plant capacity or an annual requirement.
- Bimetallic Wire:** A wire formed of two different metals joined together (not alloyed). It can include wire with a steel core clad wire, or plated or coated wire.
- Binder:** A spirally served tape or thread used for holding assembled cable components in place awaiting subsequent manufacturing operations.
- Binding Post:** A device for clamping or holding electrical conductors in a rigid position.
- Bit:** One binary (0 or 1) digit.
- Blown Jacket:** Outer cable covering applied by controlled inflation of the cured jacket tube then pulling the cable through it.
- Bond Strength:** Amount of adhesion between bonded surfaces, e.g. in cemented ribbon cable.
- Bondable Wire:** An insulated wire treated to facilitate adherence to materials such as potting compounds. Also, magnet wires used in making coils when bonding the turns together is desired.
- Bonded Cable:** Cable consisting of pre-insulated conductors or multiconductor components laid-in parallel and bonded into a flat cable. See *Solvent-Bonded*; *Adhesive-Bonded*; *Film-Bonded*.
- Bonded Construction:** An insulation construction in which the glass braid and nylon jacket are bonded together.
- Bonding:** The permanent joining of metallic parts to form an electrically conductive path that will assure electrical continuity and the capacity to conduct safely any current likely to be imposed on it.
- Booster:** A device inserted into a line (or cable) to increase the voltage.
- Boot:** (1) Protective covering over a cable, wire or connector in addition to the normal jacketing or insulation. (2) A form placed around wire termination of a multiple-contact connector to contain the liquid potting compound before it hardens.
- Braid:** A fibrous or metallic group of filaments interwoven in cylindrical form to form a covering over one or more wires.
- Braid Angle:** The smaller of the two angles formed by the shielding strand and in the axis of the cable being shielded.
- Braid Carrier:** A spool or bobbin on a braid which holds one group of strands or filaments consisting of a specific number of ends. The carrier revolves during braiding operations.

Glossary

Braid Ends: The number of strands used to make up one carrier. The strands are wound side by side on the carrier bobbin and lie parallel in the finished braid.

Braiding Machine: Machine used to apply braids to wire and cable and to produce braided sleeving and braids for tying or lacing purposes. Braiding machines are identified by the number of carriers.

Breakdown (Puncture): A disruptive discharge through the insulation.

Breakdown Voltage: The voltage at which the insulation between two conductors breaks down.

Breakout: The point at which a conductor or group of conductors breaks out from a multiconductor cable to complete circuits at various points along the main cable.

Bridge: A device used to expand a local area network by forwarding frames between data link layers.

Bridged Tap: The multiple appearances of the same cable pair at several distribution points.

British Standard Wire Gauge: A modification of the Birmingham Wire Gauge and the legal standard of Great Britain for all wires. Also known as Standard Wire Gauge (SWG), New British Standard (NBS), English Legal Standard and Imperial Wire Guide.

Broadband: In data transmission, the use of a carrier signal, rather than direct modulation, to carry several simultaneous channels.

Buffer: (fiber optic) A soft material which mechanically isolates individual fibers in a fiber optic cable or bundle from small geometrical irregularities, distortions or roughness of adjacent surfaces.

Buffing Stripper: A motorized device for removing flat cable insulation by means of buffing wheels that melt the insulation and brush it away from the conductors. Also called Abrasion Stripper.

Building Entrance Area: See *Entrance Room* or *Space, Telecommunications*.

Building Wire: Wire used for light and power, 600 volts or less, usually not exposed to outdoor environment.

Bunched Stranding: A group of strands twisted together in a random manner and the same direction without regard to geometric arrangement of specific strands.

Buncher: A machine that twists wires together in random arrangement.

Bundle: (fiber optic) A number of fibers grouped together, usually carrying a common signal.

Buried Cable: A cable installed directly in the earth without use of underground conduit. Also called "direct burial cable."

Bus: Wire used to connect two terminals inside of an electrical unit.

Bushing: A mechanical device used as a lining for an opening to prevent abrasion to wire and cable.

Butt: Joining of two conductors end-to-end, with no overlap and with the axes in line.

Butt Splice: A splice wherein two wires from opposite ends butt against each other, or against a stop, in the center of a splice.

Butt Wrap: Tape wrapped around an object or conductor in an edge-to-edge condition.

Byte: Typically a group of eight binary digits.

Cable: A stranded conductor with or without insulation and other coverings (single-conductor cable), or a combination of conductors (multiple-conductor cable). In fiber optics, a jacketed fiber or jacketed bundle in a form which can be terminated.

Cable Assembly: Typically, the cable and associated connectors; ready to install.

Cable Clamp: A device used to give mechanical support to the wire bundle or cable at the rear of a plug or receptacle.

Cable Clamp Adapter: A mechanical adapter that attaches to the rear of a plug or receptacle to allow the attachment of a cable clamp.

Cable Core: The portion of an insulated cable lying under a protective covering.

Cable Core Binder: A wrapping of tapes or cords around the conductors of a multiple-conductor cable used to hold them together.

Cable Filler: The material used in multiple-conductor cables to occupy the interslices formed by the assembly of the insulated conductors, thus forming a cable core.

Cable Rack: The vertical or horizontal open support (usually made of aluminum or steel) that is attached to a ceiling or wall.

Cable Sheath: The overall protective covering applied to cables.

Cable Tray: A ladder, trough, solid-bottom or channel raceway system intended for, but not limited to, the support of telecommunications media (e.g., cable).

Cable Vulcanizer: Compression molding machine used to repair cable jacketing that has had a part removed for splicing, for adding connectors or other devices or for replacing damaged sections.

Cabling: (1) A combination of all cables, wire, cords and connecting hardware. (2) Twisting together two or more insulated conductors by machine to form a cable. In fiber optics, a method by which a group or bundle of fibers is mechanically assembled.

Cabling Factor: Used in the formula for calculating the diameter of an unshielded, unjacketed cable. $D = Kd$, where D is the cable diameter, K is the factor and d is the diameter of one insulated conductor.

Campus: The building and grounds of a complex (e.g. a university, college, industrial park or military establishment).

Canadian Standards Association (CSA): A non-profit independent organization which operates a listing service for electrical and electronic materials and equipment. The Canadian counterpart of the Underwriter's Laboratories.

Capacitance: The ratio of the electrostatic charge on a conductor to the potential difference between the conductors required to maintain that charge.

Capacitance, Direct: The capacitance measured from one conductor to another conductor through a single insulating layer.

Capacitance, Mutual: The capacitance between two conductors (typically of a pair) with all other conductors, including shield, short circuited to ground.

Carolprene®: Proprietary rubber compound.

Carrier: The woven element of a braid consisting of one or more ends (strands) which creates the interlaced effect. Also, a spindle, spool, tube, or bobbin (on a braiding machine) containing yarn or wire, employed as a braid.

Cellular Plastics: Expanded or "foam," consists of individual closed cells of inert gas suspended in a plastic medium, resulting in a desirable reduction of the dielectric constant.

Central Office: The place where communications common carriers terminate customer lines and locate switching equipment that interconnects those lines.

Certificate of Compliance (C of C): A written statement; normally generated by a quality control department, which states that the product being shipped meets customer's specifications.

Certified Test Report (CTR): A report reflecting actual test data on the cable shipped. Tests are normally conducted by the quality control department, and show that the product being shipped meets the required test specifications.

Characteristic Impedance: The impedance that, when connected to the output terminals of a transmission line of any length, makes the line appear indefinitely long.

Chlorosulfonated Polyethylene (CSPE): A rubbery polymer used for insulations and jackets. Manufactured by E.I. DuPont under the trade name of Hypalon®.

Cigarette Wrap: Tape insulation wrapped longitudinally instead of spirally over a conductor.

Circuit: A complete path over which electrons can flow from the negative terminals of a voltage source through parts and wires to the positive terminals of the same voltage source.

Circuit Sizes: A popular term for building wire sizes 14 through 10 AWG.

Circular Mil: The area of a circle one mil (.001") in diameter; 7.854×10^{-7} sq. in. Used in expressing wire cross sectional area.

Cladding: Method of applying a layer of metal over another metal whereby the junction of the two metals is continuously welded. In fiber optics, a sheathing intimately in contact with the core of a higher refractive index material which serves to provide optical insulation and protection to the reflection interface.

Closed End Splice: An insulated splice in which two or more wires overlap and enter the splice from the same end of the barrel.

Closet, Telecommunications: An enclosed space for housing telecommunications equipment, cable terminations and cross-connect cabling. The closet is the recognized location of the cross-connect between the backbone and horizontal facilities.

Coaxial Cable: A cable consisting of two cylindrical conductors with a common axis, separated by a dielectric.

Coaxial Connector: A connector that has a coaxial construction and is used with coaxial cable.

Coherent Source: (fiber optic) A light source which emits a very narrow, unidirectional beam of light of one wavelength (monochromatic).

Coil Effect: The inductive effect exhibited by a spiral-wrapped shield, especially above audio frequencies.

Glossary

- Cold Flow:** Permanent deformation of the insulation due to mechanical force of pressure (not due to heat softening).
- Color Code:** A color system for wire or circuit identification by use of solid colors, tracers, braids, surface printing, etc.
- Commercial Building:** A building or portion thereof, that is intended for office use.
- Common Axis Cabling:** In multiple cable constructions, a twisting of all conductors about a “common axis” to result in smaller diameter constructions. Tends to result in greater susceptance to electromagnetic and electrostatic interference.
- Compact Conductor:** Stranded conductor rolled to deform the round wires to fill the normal interstices between the wires in a strand.
- Composite (Clad) Wire:** A wire having a core of one metal with a fused outer shell of different metals.
- Composite Conductor:** Two or more strands of different metals assembled and operated in parallel.
- Compound:** An insulating or jacketing material made by mixing two or more ingredients.
- Compression Cable:** A pipe type cable in which the pressure medium is separated from the insulation by a membrane or sheath.
- Concentric:** A central core surrounded by one or more layers of helically wound strands in a fixed round geometric arrangement.
- Concentric-Lay Cable:** A concentric-lay conductor, or a multiple-conductor cable composed of a central core surrounded by one or more layers of helically laid insulated conductors.
- Concentric Strand:** A strand that consists of a central wire or core surrounded by one or more layers of spirally laid wires.
- Concentricity:** The measurement of the location of the center of the conductor with respect to the geometric center of the circular insulation.
- Conductance:** The ability of a conductor to carry an electric charge. The ratio of the current flow to the potential difference causing the flow. The reciprocal of resistance.
- Conductivity:** The capacity of a material to carry electrical current—usually expressed as a percentage of copper conductivity (copper being 100%).
- Conductor:** A wire (or combination of wires not insulated from one another) suitable for carrying electric current.
- Conduit:** A rigid or flexible metallic or nonmetallic raceway of circular cross-section through which cables can be pulled or housed.
- Connecting Hardware:** A device providing mechanical cable terminations.
- Connector:** A device used to provide rapid connect/disconnect service for electrical cable and wire terminations.
- Contact:** The part of a connector which actually carries the electrical current, and are touched together or separated to control the flow.
- Contact Inspection Hole:** A hole in the cylindrical rear portion of contact used to check the depth to which a wire has been inserted.
- Contact Size:** The largest size wire which can be used with the specific contact. Also, the diameter of the engagement end of the pin.
- Continuity Check:** A test to determine whether electrical current flows continuously throughout the length of a single wire or individual wires in a cable.
- Continuous Vulcanization:** Simultaneous extrusion and vulcanization of rubber-like wire coating materials.
- Contrahelical:** Cable spiralling in an opposite direction than the preceding layer within a wire or cable.
- Control Cable:** A multi-conductor cable made for operation in control of signal circuits.
- Controlled Impedance Cable:** Package of two or more insulated conductors where impedance measurements between respective conductors are kept essentially constant throughout the entire length.
- Copolymer:** A compound resulting from the polymerization of two different monomers.
- Copper-Clad:** Steel with a coating of copper welded to it before drawing as opposed to copper-plated. Synonymous with Copperweld.
- Copperweld:** The trade name of Flexo Wire Division (Copperweld Steel Corp.) for their copper-clad steel conductors.
- Cord:** A small, flexible insulated cable.
- Cord Set:** Portable cords fitted with a wiring device at one or both ends.
- Cord, Telecommunications:** A cable using stranded conductors for flexibility, as in distribution cords or line cords. Line cords can also use tinsel conductors.
- Core:** In cables, a component or assembly of components over which other materials are applied, such as additional components, shield, sheath or armor. In fiber optics, the transparent glass or plastic section with a high refractive index through which the light travels by internal reflections.
- Corona:** A discharge due to ionization of air around a conductor due to a potential gradient exceeding a certain critical value.
- Corona Resistance:** The time that the insulation will withstand a specified level of field-intensified ionization that does not result in the immediate complete breakdown of the insulation.
- Corrosion:** The destruction of the surface of a metal by chemical reaction.
- Coupling Loss:** (fiber optic) Signal losses due to small differences in numerical aperture, core diameter, core concentricity and tolerances in splicing connectors when two fibers are aligned. Also known as Splicing Loss and Transfer Loss.
- Coupling Ring:** A device used on cylindrical connectors to lock plug and receptacle together.
- Coverage:** The calculated percentage which defines the completeness with which a metal braid covers the underlying surface. The higher percentage of coverage, the greater the protection against external interference.
- Covering:** Textile braid or jacket of rubber, plastics or other materials applied over wire and cables to provide mechanical protection and identification.
- Crazing:** The minute cracks on the surface of plastic materials.
- Creep:** The dimensional change with time of a material under load.
- Creepage:** The conduction of electricity across the surface of a dielectric.
- Creepage Path:** The path across the surface of a dielectric between two conductors.
- Creepage Surface:** An insulating surface which provides physical separation as a form of insulation between two electrical conductors of different potential.
- Crimp:** Act of compressing a connector barrel around a cable in order to make an electrical connection.
- Crimp Termination:** Connection in which a metal sleeve is secured to a conductor by mechanically crimping the sleeve with pliers, presses or automated crimping machines.
- Cross-Connect:** A facility enabling the termination of cable elements and their interconnection, and/or cross-connection, primarily by means of a patch cord or jumper.
- Cross-Linked:** Inter-molecular bonds between long-chain thermoplastic polymers by chemical or electron bombardment means. The properties of the resulting thermosetting material are usually improved.
- Crosstalk:** Undesired electrical currents in conductors caused by electromagnetic or electrostatic coupling from other conductors or from external sources. Also, leakage of optical power from one optical conductor to another.
- CSA:** Canadian Standards Association.
- C-SJ:** Same as SJ except extra-flexible conductor.
- C-SJO:** Same as SJO except extra-flexible conductor.
- Cure:** To change the physical properties of a material by chemical reaction.
- Curing Cycle:** The time, temperature and pressure required for curing.
- Curl:** The degree to which a wire tends to form a circle after removal from a spool. An indication of the ability of the wire to be wrapped around posts in long runs.
- Current:** The rate of transfer of electricity. Practical unit is the ampere which represents the transfer of one coulomb per second. In a simple circuit, current (I) produced by a cell or electromotive force (E) when there is an external resistance (R) and internal resistance (r) is: $I = \frac{E}{R+r}$
- Current Carrying Capacity:** The maximum current an insulated conductor can safely carry without exceeding its insulation and jacket temperature limitations.
- Customer Premises:** Building(s) with grounds and appurtenances (belongings) under the control of the customer.
- Cut-Through Resistance:** The ability of a material to withstand mechanical pressure, usually a sharp edge or small radius, without separation.
- Cycle:** The complete sequence including reversal of the flow of an alternating electric current.
- Decibel (dB):** A unit to express differences of power level. Used to express power gain in amplifiers or power loss in passive circuits or cables.
- Delay Line:** A cable made to provide very low velocity of propagation with long electrical delay for transmitted signals.
- Demarcation Point:** A point where the operational control or ownership changes.

Glossary

- Depth of Crimp:** Thickness of the crimped portion of a connector measured between two opposite points on the crimped surface.
- Derating Factor:** A factor used to reduce the current carrying capacity of a wire when used in environments other than that for which the value was established.
- Detector:** (fiber optic) A device that picks up light from fiber and converts the information into an electrical signal.
- Device, As Related to a Work Station:** An item such as a telephone, personal computer or graphic or video terminal.
- Device, As Related to Protection:** A protector, a protector mount, a protector unit or a protector module.
- Dielectric:** An insulating medium which intervenes between two conductors and permits electrostatic attraction and repulsion to take place across it.
- Dielectric Breakdown:** The voltage required to cause an electrical failure or breakthrough of the insulation.
- Dielectric Constant (K):** The ratio of the capacitance of a condenser with dielectric between the electrodes to the capacitance when air is between the electrodes. Also called Permittivity and Specific Inductive Capacity.
- Dielectric Loss:** Power dissipated in an insulating medium as the result of the friction caused by molecular motion when an AC electric field is applied.
- Dielectric Strength:** The voltage which an insulation can withstand before breakdown occurs. Usually expressed as a voltage gradient (such as volts per mil).
- Dielectric Test:** A test in which a voltage higher than the rated voltage is applied for a specified time to determine the adequacy of the insulation under normal conditions.
- Digital:** Transmission data representative by discrete characters.
- Dip Coating:** An insulating coating applied to the conductor by passing the conductor through an applicator containing liquid insulating medium.
- Direct Burial Cable:** A cable installed directly in the earth.
- Direct Capacitance:** The capacitance measured directly from conductor to conductor through a single insulating layer.
- Direct Current (d.c.):** An electric current which flows in only one direction.
- Direct Current Resistance (DCR):** The resistance offered by any circuit to the flow of direct current.
- Direction of Lay:** The lateral direction in which the strands of a conductor run over the top of the cable conductor as they recede from an observer looking along the axis of the conductor or cable. Also applies to twisted cable.
- Discrete Wiring:** Wire or wires having distinct identity and purpose.
- Dispersion:** (fiber optic) The variation of the refractive index of a material with wavelength, causing light of different wavelengths to travel at different velocities in the material.
- Disruptive Discharge:** A sudden, large increase in current through an insulation medium due to the complete failure of the medium under the electrostatic stress.
- Dissipation Factor:** The tangent of the loss angle of the insulating material. (Also referred to as loss tangent, $\tan \delta$, and approximate power factor.)
- Distribution Cable:** In telecommunications and CATV systems, the transmission cable between the distribution amplifier and the drop wire.
- Distribution Frame:** A structure with terminations for connecting the permanent cabling of a facility in such a manner that interconnection or cross-connections may be readily made.
- Disturbed Conductor:** A conductor that receives energy generated by the field of another conductor or an external source such as a transformer.
- Drain Wire:** In a cable, the uninsulated wire laid over the component or components and used as a ground connection.
- Draw Feed Stock:** Rod or wire that is subsequently drawn to a smaller size.
- Drawing:** In wire manufacture, pulling the metal through a die or series of dies to reduce diameter to a specified size.
- Drop Ceiling:** See *False Ceiling*.
- Drop Wire:** In telecommunications and CATV systems, the transmission cable from the distribution cable to a dwelling.
- Dual Coaxial Cable:** Two individually insulated conductors laid parallel or twisted and placed within an overall shield and sheath.
- Duct:** 1) A single enclosed raceway for wires or cables. See also *Conduit, Raceway*; 2) a single enclosed raceway for wires or cables usually used in soil or concrete, 3) an enclosure in which air is moved. Generally part of the HVAC system of a building.
- Duplex:** Two way data transmission on a four-wire transmission line or two fiber.
- Duplex Cable:** (1) A cable composed of two insulated single-conductor cables twisted together. (2) A cable composed of two fibers, typically 62.5/125 μm multimode, placed in parallel under a thermoplastic sheath.
- Duplex Parallel:** Typically used in the thermocouple industry to denote two parallel conductors of dissimilar metals insulated in parallel without twist and jacketed. Commonly applied to thermocouple grades and extension wires.
- Eccentricity:** Like concentricity, a measure of the center of a conductor's location with respect to the circular cross section of the insulation. Expressed as a percentage of displacement of one circle within the other.
- Eddy Current:** Circulating currents induced in conducting materials by varying magnetic fields.
- Elastomer:** A rubber or rubber-like material which will stretch repeatedly to 200 percent or more and return rapidly and with force to its approximate original shape.
- Electro-Tinned:** Electrolytic process of tinning wire using pure tin.
- Electrode:** A conductor through which a current enters or leaves a nonmetallic conductor.
- Electromagnetic Coupling:** Energy transfer by means of a varying magnetic field.
- Electromagnetic Field:** A rapidly moving electric field and its associated moving magnetic field.
- Electromagnetic Induction:** The production of a voltage in a coil due to a change in the number of magnetic lines of forces (flux linkages) passing through the coil.
- Electromagnetic Interference (EMI):** The interference in signal transmission or reception resulting from the radiation of electrical and magnetic fields. Synonym: Radio Frequency Interference.
- Electromotive Force (e.m.f.):** Pressure or voltage. The forces which cause current to flow in a circuit.
- Electronic Wire and Cable:** A length of conductive or semiconductive material used in an electronic application.
- Electrostatic:** Pertaining to static electricity, or electricity at rest. An electric charge, for example.
- Elongation:** The fractional increase in the length of a material stressed in tension.
- Embossing:** A marker identification by means of thermal indentation leaving raised lettering on the sheath material of cable.
- Emergency Overload:** Load which occurs when larger than normal currents are carried through a cable or wire over a certain period of time.
- Enameled Wire:** A conductor with a baked-on enamel film insulation. In addition to magnet wire, enameled insulation is used on thermocouple type wires and other wires.
- Ends:** In braiding, the number of essentially parallel wires of threads on a carrier.
- Energize:** To apply rated voltage to a circuit or device in order to activate it.
- Entrance Facility, Telecommunications:** An entrance to a building for both public and private network service cables (including antennae) including the entrance point at the building wall and continuing to the entrance room or space.
- Entrance Point, Telecommunications:** The point of emergence of telecommunications conductors through an exterior wall, a concrete floor slab or from a rigid metal conduit or intermediate metal conduit.
- Entrance Room or Space, Telecommunications:** A space in which the joining of inter- or intra-building telecommunications backbone facilities takes place. An entrance room may also serve as an equipment room.
- Equilay:** More than one layer of helically laid wires with the direction of lay reversed for successive layers, but with the length of lay the same for each layer.
- Equipment Room, Telecommunications:** A centralized space for telecommunications equipment that serves the occupants of the building. An equipment room is considered distinct from a telecommunications closet because of the nature of complexity or the equipment.
- Etched Wire:** A process applied to fluoroplastic wire in which the wire is passed through a sodium bath to create a rough surface to allow epoxy resin to bond the fluoroplastic.
- Exit Angle:** The angle between the output radiation vectors and the axis of the fiber or fiber bundle.
- External Interference:** The effects of electrical waves or fields which cause sounds other than the desired signal. Static.

Glossary

- External Wiring:** Electronic wiring which interconnects subsystems within the system.
- Extruded Cable:** Cable with conductors which are uniformly insulated and formed by applying a homogeneous insulation material in a continuous extrusion process.
- Extrusion:** Method of continuously forcing plastic, rubber, or elastomer material through an orifice to apply insulation or jacketing over a conductor or cable core.
- False Ceiling:** A ceiling that creates an area or space between the ceiling material and the structure above the material. Synonym: *Drop Ceiling, Suspended Ceiling.*
- Farad:** A unit of electrical capacity.
- Fatigue Resistance:** Resistance to metal crystallization which leads to conductors or wires breaking from flexing.
- Feed-Through Insulators:** Insulators that carry a metal conductor through the chassis while preventing the "hot" lead from shorting to the ground chassis.
- Feedback:** Energy that is extracted from a high-level point in a circuit and applied to a lower level. Positive feedback reduces the stability of a device and is used to increase the sensitivity or produce oscillation in a system. Negative feedback, also called inverse feedback, increases the stability of a system as the feedback improves stability and fidelity.
- Feeder Cable:** In telecommunication or CATV systems, the transmission cable from the head end (signal pickup) to the trunk amplifier. Also called a trunk cable.
- Feedthrough:** (1) A conductor that connects patterns on opposite sides of a PCB. Also called Interfacial connection. (2) A connector or terminal block, usually having double-ended terminals which permit simple distribution and bussing of electrical circuits.
- Ferrous:** Composed of and/or containing iron. A ferrous metal exhibits magnetic characteristics.
- Ferrule:** A short tube used to make solderless connections to shielded or coaxial cable.
- Fiber:** A thread or threadlike structure. Also, a single discrete element used to transmit optical (light wave) information.
- Fiber Dispersion:** (fiber optic) Pulse spreading in a fiber caused by differing transit times of various modes.
- Fiber Optics:** A lightwave or optical communications system in which electrical information is converted to light energy, transmitted to another location through optical fibers, and is there converted back into electrical information.
- Fiber Tubing:** A loose, crush-resistant cylinder applied over individual fibers to provide mechanical protection.
- Field:** An area of influence around a magnet or electric charge.
- Field Coil:** A suitable insulated winding to be mounted on a field pole to magnetize it.
- Figure 8 Cable:** An aerial cable configuration in which the conductors and the steel strand which supports the cable are integrally jacketed. A cross-section of the finished cable approximates the figure "eight."
- Filament:** Fiber characterized by extreme length.
- Filled Cable:** A telephone cable construction in which the cable core is filled with a material that will prevent moisture from entering or passing through the cable.
- Filler:** (1) A material used in multiconductor cables to occupy large interstices formed by the assembled conductors. (2) An inert substance added to a compound to improve properties or decrease cost.
- Film:** A thin plastic sheet.
- Fine Stranded Wire:** Stranded wire with component strands of 36 AWG or smaller.
- Firestop:** A material, device or assembly of parts installed in a cable system in a fire-rated wall or floor to prevent passage of flame, smoke or gasses through the rated barrier.
- Flame Resistance:** The ability of a material not to propagate flame once the heat source is removed.
- Flammability:** The measure of the material's ability to support combustion.
- Flashover:** A disruptive discharge around or over the surface of a solid or liquid insulator.
- Flat Braid:** A woven braid of tinned copper strands rolled flat at time of manufacture to a specified width.
- Flat Cable:** A cable with two smooth or corrugated but essentially flat surfaces.
- Flat Conductor:** A wire having a rectangular cross-section as opposed to a round or square conductor.
- Flat Conductor Cable:** A cable with a plurality of flat conductors.
- Flexfoil®:** Proprietary aluminum laminated shielding tapes.
- Flex Life:** The measurement of the ability of a conductor or cable to withstand repeated bending.
- Flexibility:** The ease with which a cable may be bent.
- Flexible:** That quality of a cable or cable component which allows for bending under the influence of outside force, as opposed to limpness which is bending due to the cable's own weight.
- Floating:** Referring to a circuit which has no connection to ground.
- Flux:** (1) The lines of force which make up an electrostatic field. (2) The rate of flow of energy across or through a surface. (3) A substance used to promote or facilitate fusion.
- FNC:** Federal Networking Council (formerly FRICC).
- Foamed Plastics:** See *Cellular Plastic.*
- Foil:** A thin, continuous sheet of metal.
- Free Connector:** A connector for attachment to the free end of a wire or cable.
- Frequency:** The number of times a periodic action occurs in a unit of time. The number of cycles that an electric current completes in one second.
- Frequency Response:** The characteristic of a device denoting the range of frequencies over which it may be used effectively.
- Funnel Entry:** Flared or widened entrance to a terminal or connector wire barrel.
- Fuse Wire:** Wire made from an alloy that melts at a relatively low temperature.
- Fused Coating:** A metallic coating which has been melted and solidified, forming a metallurgical bond to the base material.
- Fused Conductors:** Individual strands of heavy tinned copper wire stranded together and then bonded together by induction heating.
- Fused Spiral Tape:** A PTFE insulated hookup wire. The spiral wrapped conductor is passed through a sintering oven where overlaps are fused together.
- Gain:** The increase of voltage, current or power over a standard or previous reading. Usually expressed in decibels.
- Galvanometer:** An instrument for detecting or measuring small electrical current.
- Gas-Filled Cable:** A self-contained pressure cable in which the pressure medium is an inert gas having access to the insulation.
- Gauge:** A term used to denote the physical size of a wire.
- Giga:** A numerical prefix denoting one billion (10⁹).
- Gigahertz (GHz):** A unit of frequency equal to one billion hertz.
- Gimmick:** A short length of wire soldered onto a circuit component and used as a small adjustable capacitor.
- Graded-Index:** A type of optical fiber in which the refractive index of the core is in the form of a parabolic curve, decreasing toward the cladding. This type of fiber provides high bandwidth capabilities.
- Ground:** A conducting connection, whether intentional or accidental, between an electrical circuit (e.g. telecommunications) or equipment and the earth, or to some conducting body that serves in place of the earth.
- Ground Conductor:** A conductor in a transmission cable or line that is grounded.
- Ground Insulation:** The insulation used between a winding and the magnetic core or other structural parts, usually at ground potential.
- Ground Loop:** The generation of undesirable current flow within a ground conductor, owing to the circulation currents which originate from a second source of voltage.
- Ground Plane:** Expanded copper mesh which is laminated into some flat cable constructions as a shield.
- Ground Potential:** Zero potential with respect to the ground or earth.
- Hard Drawn Copper Wire:** Copper wire that has not been annealed after drawing.
- Harness:** An arrangement of wires and cables usually with many breakouts, which have been tied together or pulled into a rubber or plastic sheath, used to interconnect an electric circuit.
- Hash Mark Stripe:** A non-continuous helical stripe applied to a conductor for identification.
- Heat Distortion:** Distortion of flow of a material or configuration due to the application of heat.
- Heat Seal:** Method of sealing a tape wrap jacket by means of thermal fusion.
- Heater Cord:** Flexible stranded copper conductor, cotton wrapped, with rubber insulation and asbestos roving.
- Helical Stripe:** A continuous, colored, spiral stripe applied to a conductor for circuit identification.
- Helix:** Spiral winding.
- Henry:** The unit of inductance.
- Hertz (Hz):** A term replacing cycles-per-second as an indication of frequency.
- Heterogeneous Insulation:** A cable insulating system composed of two or more layers of different insulating materials.

Glossary

High-Temperature Wire and Cable: Electrical wire and cables having thermal operating characteristics of 150°C and higher.

High Voltage: Generally, a wire or cable with an operating voltage of over 600 volts.

Holding Strength: Ability of a connector to remain assembled to a cable when under tension.

Homogeneous Insulation: A complete cable insulation structure whose components cannot be identified as layers of different materials.

Hook-up Wire: A wire used for low-current, low-voltage (under 1000 volts) applications within enclosed electronic equipment.

Horizontal Cabling: The wiring/cabling between the telecommunications outlet/connector and the horizontal cross-connect.

Horizontal Cross-Connect: A cross-connect of horizontal cabling to other cabling, e.g. horizontal, backbone or equipment.

Hot Stamping: Method of alpha numerical coding. Identification markings are made by pressing heated type and marking foil into softened insulation surfaces. See Surface Printing.

Hot Tin Dip: A process of passing bare wire through a bath of molten tin to provide a coating.

Hybrid Cable: An assembly of two or more cables (of the same or different types or categories) covered by one overall sheath.

Hygroscopic: Capable of absorbing moisture from the air.

Hypalon®: DuPont's trade name for their chlorosulfonated polyethylene, an ozone-resistant synthetic rubber.

Impact Tool: Device used to punch new conductor onto IDs. This tool is typically equipped with a cutting blade for either 66 or 110 blocks.

Impedance: The total opposition that a circuit offers to the flow of alternating current or any other varying current at a particular frequency. It is a combination of resistance R and reactance X, measured in Ω .

Impedance-Matching Transformer: A transformer designed to match the impedance of one circuit to that of another (BALUN).

Impulse: A surge of unidirectional polarity.

Impulse Strength: The voltage breakdown of insulation under voltage surges on the order of microseconds in duration.

Impulse Test: An insulation test in which the voltage applied is an impulse voltage of specified wave shape.

Incoherent Source: (fiber optic) A light source which emits wide, diffuse beams of light of many wave lengths.

Index-Matching Fluid: (fiber optic) Fluid with refractive index same as fiber core; used to fill air gap between fiber ends at connectors.

Index of Refraction: The ratio of light velocity in a vacuum to its velocity in a given transmitting medium.

Inductance: The property of a circuit or circuit element that opposes a change in current flow, thus causing current changes to lag behind voltage changes. It is measured in henrys.

Inductive Coupling: Crosstalk resulting from the action of the electromagnetic field of one conductor on the other.

Infrastructure, Telecommunications: A collection of those telecommunications components, excluding equipment, that together provide the basic support for the distribution of all information within a building or campus.

Insertion Loss: As measure of the attenuation of a device by determining the output of a system before and after the device is inserted into the system.

Insertion Tool: A small, hand-held tool used to insert contacts into a connector.

Insulated Wire: A conductor of electricity covered with a non-conducting material.

Insulating Joint: A device which mechanically couples and electrically insulates the sheath and armor of contiguous lengths of cable.

Insulation: A material having high resistance to the flow of electric current. Often called a dielectric in radio frequency cable.

Insulation Adhesion: The degree of tightness of the insulation over the base conductor, measured in terms of force required to remove a specified length of insulation from the wire.

Insulation Crimp: The area of a terminal, splice or contact that has been formed around the insulation of the wire.

Insulation Grip: Extended cylinders at the rear of crimp-type contacts designed to accept the bared wire and a small length of its insulation.

Insulation Piercing: A method of crimping whereby lances cut the insulation of the wires and enter into the strands to make electrical contact.

Insulation Resistance: The ratio of the applied voltage to the total current between two electrodes in contact with a specific insulation, usually expressed in meg Ω -M feet.

Insulation System: All of the insulation materials used to insulate a particular electrical or electronic product.

Integral Belt: A layer of insulation or semiconductive material applied by extrusion over two or more insulated, twisted or parallel conductors, to form a round, smooth diameter.

Interconnect: A connection scheme that provides for the direct connection of individual cables to another cable or to an equipment cable without a patch cord.

Interconnecting Cable: The wiring between modules, between units or the larger portions of a system.

Interconnecting Wire: The physical wiring between components (outside a module), between modules, between units or between larger portions of a system or systems.

Interconnection: Mechanically joining devices together to complete an electrical circuit.

Interface: The two surfaces on the contact side of both halves of a multiple-contact connector which face each other when the connector is assembled.

Intermediate Cross-Connect: A cross-connect between 1st level and 2nd level backbone cabling.

Internal Wiring: Electronic wiring which interconnects components, usually within a sealed subsystem.

Interstices: Voids or valleys between individual strands in a conductor or between insulated conductors in a multiconductor cable.

Ionization Voltage (Corona Level): The minimum value of falling rms voltage which sustains electrical discharge within the vacuum or gas-filled spaces in the cable construction or insulation.

Irradiation: In insulations, the exposure of the material to high energy emissions for the purpose of favorably altering the molecular structure.

Jack: A plug-in type terminal widely used in an electronic apparatus for temporary connections.

Jacket: An outer protective sheath over primary insulation, braids, shields, cable components or over the cable itself. In fiber optics, a covering, over a fiber, bundle of fibers or cable which protects against the environment.

JAN Specification: Joint Army-Navy specification (replaced by current Military Specifications).

Jumper: An assembly of twisted pairs without connectors, used to join telecommunications circuits/links at the cross connect.

Junction: A point in a circuit where two or more wires are connected.

Keying: The mechanical feature of a connector system that guarantees correct orientation of a connection, or prevents the connection to a jack, or to an optical fiber adapter of the same type intended for another purpose.

Kynar®: Penwalt trade name for polyvinylidene fluoride. Typically used as insulation for wire wrap wire.

Lacing and Harnessing: A method of grouping wires by securing them in bundles of designated patterns.

Lacquer: A liquid resin or compound applied to textile braid to prevent fraying, moisture absorption, etc.

Laminated Tape: A tape consisting of two or more layers of different materials bonded together.

Laser Diode: (fiber optic) A semiconductor diode that, when pulsed, a laser diode emits coherent light.

Launch Angle: (fiber optic) The angle between the radiation vector and the axis of the fiber or fiber bundle.

Lay: The length measured along the axis of a wire or cable required for a single strand (in stranded wire) or conductor (in cable) to make one complete turn about the axis of the conductor or cable.

Layer: Consecutive turns of a coil lying in a single plane.

Leaching and Non-Leaching: In a leaching wire, the plasticizer will migrate when exposed to heat. A non-leaching wire will retain its plasticizer under extreme temperature conditions and remain flexible after baking.

Lead: A wire, with or without terminals, that connects two points in a circuit.

Lead-Cured: A cable that is cured or vulcanized in a metallic lead mold.

Lead Dress: The placement or routing of wire and component leads in an electrical circuit.

Lead-in: The conductor or conductors that connect the antenna proper to electronic equipment.

Leakage Current: The undesirable flow of current through or over the surface of an insulation.

Glossary

- Life Cycle:** A test to determine the length of time before failure in a controlled, usually accelerated, environment.
- Light Commercial Building:** A building or portion thereof that is intended for use with one to four (1-4) non-residential exchange access lines per tenant.
- Light-Intensity Ratio:** (fiber optic) Ratio of input light intensity to the output light intensity.
- Light Source:** (fiber optic) An object capable of emitting light. In fiber optics, the light source is normally an LED or a laser.
- Lightguide:** (fiber optic) A flexible bundle of fibers used to transmit light.
- Lightwave Communications:** (fiber optic) Communications using light to carry the information.
- Limits of Error:** The maximum deviation (in degrees of percent) of a thermocouple or thermocouple extension wire from standard emf-temperature to be measured.
- Limpness:** The ability of a cable to lay flat or conform to a surface.
- Line Balance:** The degree to which the conductors of a cable are alike in their electrical characteristics with respect to each other, to other conductors and to ground.
- Line Drop:** A voltage loss occurring between any two points in a transmission line, due to the resonance, reactance or leakage of the line.
- Line Loss:** The total of the various energy losses occurring in a transmission line.
- Line Voltage:** Voltage existing in a cable or circuit.
- Link:** An assembly of telecommunications facilities between two points, not including terminal equipment.
- Listed:** Equipment included in a list published by an organization, acceptable to the authority having jurisdiction, that maintains periodic inspection of production of listed equipment, and whose listing states either that the equipment or material meets appropriate standards or has been tested and found suitable for use in a specified manner.
- Local Area Network (LAN):** A geographically limited communications network intended for the local transport of data, video and voice.
- Longitudinal Shield:** A tape shield, flat or corrugated, applied longitudinally with the axis of the core being shielded.
- Longitudinal Wrap:** Tape applied longitudinally with the axis of the core being covered.
- Loop Resistance:** The total resistance of two conductors measured round-trip from one end. Commonly used term in the thermocouple industry.
- Looping-in:** Wiring method which avoids tee joints by carrying the conductor or cable to and from the point to be supplied.
- Loss:** Energy dissipated without accomplishing useful work.
- Loss Factor:** The product of the dissipation and dielectric constant of an insulating material.
- Lossy Line:** A cable having large attenuation per unit of length.
- Low-Loss Dielectric:** An insulating material that has a relatively low dielectric loss, such as polyethylene or Teflon®.
- Low-Noise Cable:** Cable configuration specially constructed to eliminate spurious electrical disturbances caused by capacitance changes or self-generated noise induced by either physical abuse or adjacent circuitry.
- Low Tension:** Low voltage, as applied to ignition cable.
- Lug:** Termination, usually crimped or soldered to the conductor, with provision for screwing on to the terminal.
- m:** Meter.
- Magnetic Wire:** Insulated wire intended for use in windings on motor, transformer and other coils for electromagnetic devices.
- Magnetic Field:** The region within which a body or current experiences magnetic force.
- Magnetic Flux:** The rate of flow of magnetic energy across or through a surface (real or imaginary).
- Magnetic Noise:** Caused by change in current level, e.g. ac powerline (creates magnetic field around the cable) this magnetic field causes the magnetic noise.
- Main Cross-Connect:** A cross-connect for 1st level backbone cables, entrance cables and equipment cables.
- Marker Tape:** A tape laid parallel to the conductors under the sheath in a cable, imprinted with the manufacturer's name and the specification to which the cable is made.
- Master Antenna Television (MATV):** A combination of components providing multiple television receiver operations from one antenna or group of antennas normally on a single building.
- Material Scattering Loss:** (fiber optics) Loss due to fluctuations in the refractive index and to inhomogeneities in material composition and temperature.
- Media, Telecommunications:** Wire, cable or conductors used for telecommunications.
- Megarad:** A unit for measuring radiation dosage.
- Messenger:** Supporting member, usually a high-strength steel wire, used to suspend aerial cable. The messenger may be an integral part of the cable, or exterior to it (lashed messenger).
- Microbending Loss:** (fiber optic) Loss due to small geometrical irregularities along the core-clad interface of the fiber.
- Microfarad:** One-millionth of a farad, commonly abbreviated m-F.
- Micromicrofarad:** One-millionth of a microfarad. (uuf, uufd, mmf, mmfd $\mu''\mu$. F are common abbreviations.)
- Microwave:** A short (usually less than 30 cm.) electrical wave.
- Mil:** A unit used in measuring diameter of a wire or thickness of insulation over a conductor. One-one thousandth of an inch (.001").
- Mineral-Insulated:** Cable and thermocouple wire consisting of one or more conductors surrounded by magnesium oxide insulation and enclosed in a liquid- and gas-tight metallic sheathing.
- Miniature Wire:** Insulated conductors of approximately 20-34 AWG.
- Mis-Match:** A termination having a different impedance than that for which a circuit or cable is designed.
- Mode:** One of the components of a general configuration of a propagating wave front.
- Modem:** Device which places and receives data signals over a common carrier's communication facility.
- Modular Jack:** This term is outmoded; see *Outlet/Connector, Telecommunications*.
- Modular Plug:** A telecommunications connector for wire or cords per the Part 68 Rules. A modular plug can have 6 or 8 contact positions, but not all the positions need be equipped with contacts.
- Modulation:** A process whereby certain characteristics of a wave, often called the carrier, are varied or selected in accordance with a modulating function.
- Modulus of Elasticity:** The ratio of stress to strain in an elastic material.
- Moisture Absorption:** The amount of moisture, in percentage, that a material will absorb under specified conditions.
- Moisture Resistance:** The ability of a material to resist absorbing moisture from the air or when immersed in water.
- Molded Plug:** A connector molded on either end of a cord or cable.
- Monomer:** The basic chemical unit used in building a polymer.
- Motor Lead Wire:** Wire which connects to the fragile magnet wire found in coils, transformers and stator or field windings.
- Multiconductor:** More than one conductor within a single cable complex.
- Multimode Optical Fiber:** An optical fiber that will allow many bound modes to propagate. The fiber may be either a graded-index or step-index fiber. See also: *Optical Fiber Cable*.
- Multiple Conductor Cable:** A combination of two or more conductors cabled together and insulated from one another and from sheath or armor where used.
- Multiple Conductor Concentric Cable:** An insulated central conductor with one or more tubular stranded conductors laid over it concentrically and insulated from one another.
- Multiplexing:** Simultaneous transmission of two or more messages over the same cable pair.
- Mutual Capacitance:** Capacitance between two conductors when all other conductors are connected together to shield and ground.
- Mylar®:** DuPont trademark for polyester film.
- Nanometer (nm):** One billionth of a meter (10^{-9} meter).
- Nanosecond:** One billionth of a second (10^{-9} seconds).
- National Electric Code (NEC):** A set of regulations governing construction and installation of electrical wiring and apparatus in the United States, established by the American National Board of Fire Underwriters.
- Neoprene:** A synthetic rubber with good resistance to oil, chemical and flame. Also called polychloroprene.
- Noise:** In a cable or circuit, any extraneous signal which tends to interfere with the signal normally present in or passing through the system.
- Nomex®:** DuPont trademark for a temperature-resistant, flame-retardant nylon.
- Non-Contaminating:** Type of PVC jacket material whose plasticizer will not migrate into the dielectric of a coaxial cable and thus avoids contaminating and destroying the dielectric.

Glossary

Nylon: Thermoplastic with good chemical and abrasion resistance.

NVP: Nominal Velocity of Propagation.

Off Center: Conductor displaced within the cross-section of its insulation.

Offgassing: Percentage of a specified gas released during the combustion of insulation or jacketing material.

Ohm: A unit of electrical resistance.

Oil Aging: Cable aged in an accelerated manner by placement in an oil bath and heated to a pre-set temperature for a stated time.

Oil-Filled Cable: A self-contained pressure cable in which the pressure medium is low viscosity oil having access to the insulation.

Opaque: (fiber optic) Not permitting the passage of light.

Open Cell: Foamed or cellular material with cells which are generally interconnected.

Optical Communication Cable: (fiber optic) Fiber with a protective jacket around it.

Optical Conductors: (fiber optic) Materials which offer a low optical attenuation to transmission of light energy.

Optical Fiber Cable: An assembly consisting of one or more optical fibers.

Optical Fiber Duplex Adapter: A mechanical media termination device designed to align and join two duplex connectors.

Optical Fiber Duplex Connector: A mechanical media termination device designed to transfer optical power between two pairs of optical fibers.

Optical Waveguide: (fiber optic) A fiber used for optical communications. Analogous to a waveguide used for microwave communications.

Oscillatory Surge: A surge which includes both positive and negative polarity values.

Outgassing: The dissipation of gas from a dielectric evidencing decomposition.

Outlet Box, Telecommunications: A metallic or nonmetallic box mounted within a wall, floor or ceiling and used to hold telecommunications outlet/connectors or transition devices.

Outlet/Connector, Telecommunications: A connecting device in the work area on which horizontal cable terminates.

Overall Diameter: Finished diameter over wire or cable.

Overcoat Conductor: A stranded conductor made from individual strands of tin-coated wire stranded together, and then given an overall tin coat.

Overlap: The amount the trailing edge laps over the leading edge of a spiral tape wrap.

Oxygen Index: Percentage of oxygen necessary to support combustion in a gas mixture.

Ozone: Reactive form of oxygen, typically found around electrical discharges and present in the atmosphere in small quantities.

Packing Fraction: (fiber optic) The ratio of active cross-sectional area of fiber core, or cores, to the total end surface of the fiber, or fiber bundle.

Pair: Two insulated wires of a single circuit associated together, also known as a "balance" transmission line.

Parallel Pair: A duplex construction of two insulated conductors laid parallel and then covered overall with a braid or jacket.

Parallel Stripe: A stripe applied longitudinally on a wire or cable parallel to the axis of the conductor.

Patch Cord: A length of cable with connectors on one or both ends used to join telecommunications links/circuits at the cross-connect.

Patch Cord Cable: Bulk cable used in the manufacture of patch cords.

Patch Panel: A cross-connect system of mateable connectors that facilitates administration.

Pathway: A facility for the placement of telecommunications cable. Synonym: *Raceway*.

Pay-Off: The process of feeding a cable or wire from a bobbin, reel or other package.

Percent Plating: Quantity of plating on a conductor expressed as a percentage by weight.

Percentage Conductivity: Conductivity of a material expressed as a percentage of that of copper.

Periodicity: The uniformly spaced variations in the insulation diameter of a transmission cable that result in reflections of a signal, when its wavelength or a multiple thereof is equal to the distance between two diameter variations.

Permittivity: See *Dielectric Constant*.

Phase: An angular relationship between waves.

Phase Shift: A change in the phase relationship between two alternating quantities.

Photodetector (Receiver): Converts light energy to electrical energy.

Pick: Distance between two adjacent crossover points of braid filaments. The measurement in picks per inch indicates the degree of coverage.

Picofarad: One-millionth of one-millionth of a farad. A micromicrofarad or picofarad (abbreviation pf). (See $\mu\mu\text{F}$).

Pigtail Wire: Fine-stranded, extra-flexible, rope-lay lead wire attached to a shield for terminating purposes.

Pitch: In flat cable, the nominal distance between the index edges of two adjacent conductors.

Pitch Diameter: Diameter of a circle passing through the center of the conductors in any layer of a multiconductor cable.

Plain Conductor: A conductor consisting of only one metal.

Plain Weave: A weave used on woven cables. Threads between the wires act as binders and give the cable lateral stiffness and linear flexibility. Also called Standard and Square Weave.

Planetary Cabler: A cabler capable of laying down any number of shielded, overbraided or jacketed singles, pairs, called groups, or any combination of them in sequence.

Planetary Twister: A twisting machine whose payoff spools are mounted in rotating cradles that hold the axis of the spool in a fixed direction as the spools are revolved so no twist is built up in each wire.

Plastic Deformation: Change in dimensions under load that is not recovered when the load is removed.

Plasticizer: A chemical agent added to plastics to make them softer and more pliable.

Plenum: The air return path of a central air handling system, either ductwork or open space over a suspended ceiling.

Plenum Cable: Cable approved by a recognized agency such as UL for installation in plenums without the need for conduit.

Plug: The part of the two mating halves of a connector which is moveable when not fastened to the other mating half.

Ply: The number of individual strands or filaments twisted together to form a single thread.

Point-to-Point: A type of connection established between two specific locations, as between two buildings.

Point-to-Point Wiring: An interconnecting technique wherein the connections between components are made by wires routed between connecting points.

Polarization: The orientation of a flat cable or a rectangular connector.

Polishing: (fiber optic) Act of smoothing ends of fibers to an 'optically smooth' finish, generally using abrasive.

Polyester: Polyethylene terephthalate, used extensively as a moisture-resistant cable core wrap.

Polyethylene: A thermoplastic material having excellent electrical properties.

Polyhalocarbon: A general name for polymers containing halogen atoms. The halogens are fluorine, chlorine, bromine and iodine.

Polymer: A material of high molecular weight formed by the chemical union of monomers.

Polyolefin: Any of the polymers and copolymers of the ethylene family of hydrocarbons.

Polypropylene: A thermoplastic similar to polyethylene but stiffer and having higher softening point (temperature); excellent electrical properties.

Polyurethane: Class of polymers known for good abrasion and solvent resistance (may be applied in solid or cellular form).

Porosity: Multiple voids in an insulation cross-section.

Potting: The sealing of a cable termination or other component with a liquid which thermosets into an elastomer.

Power Cables: Cables of various sizes, construction and insulation, single or multi-conductor designed to distribute primary power to various types of equipment.

Power Factor: The ratio of resistance to impedance. The ratio of the actual power of an alternating current to apparent power. Mathematically, the cosine of the angle between the voltage applied and the current resulting.

Pre-Bond: Stranded wire which has been fused, topcoat-tinned or overcoat-tinned.

Prewiring: Wiring installed

- Before walls are enclosed or finished.

- In anticipation of future use or need.

Primary: The transformer winding which receives the energy from a supply circuit.

Primary Insulation: The first layer of non-conductive material applied over a conductor, whose prime function is to act as electrical insulation.

Primary Protection: The minimum protection required on all exposed facilities to comply with NEC requirements.

Primary Wiring: A printed circuit intended to provide point-to-point electrical connections.

Programming: Ability to select various circuit patterns by interconnecting appropriate contacts on one side of a connector plug or panel.

Propagation Delay: Time delay between input and output of signal.

Glossary

- Propagation Time:** Time required for a wave to travel between two points on a transmission line.
- Protocol:** A set of rules for communicating.
- Proximity Effect:** Nonuniform current distribution over the cross-section of a conductor caused by the variation of the current in a neighboring conductor.
- Pull Box:** A device to access a raceway used to facilitate placing of wire or cables.
- Pull Cord/Pull Wire:** Cord or wire placed within a raceway and used to pull wire and cable through the raceway.
- Pull Strength:** See *Pull Tension*.
- Pull Tension:** The maximum pulling force that can be safely applied to a cable without damage.
- Pulling Eye:** A device used to pull cable into or from a duct.
- Pulse:** Energy which changes abruptly from an intensity to another. May be light energy or electrical energy.
- Pulse Cable:** A type of coaxial cable constructed to transmit repeated high-voltage pulses without degradation.
- Polyvinyl Chloride (PVC):** A general-purpose thermoplastic widely used for wire and cable insulations and jackets.
- Quad:** A series of four separately insulated conductors, generally twisted together in pairs. Also, a series-parallel combination of transistors with increased reliability because failure of one transistor will not disable the entire circuit.
- Quadders:** Three-bay machines which can twist four wires together and cable braided and shielded wires with varying lay lengths.
- Raceway:** Any channel designed for holding wires or cables, e.g. conduit, electrical metallic tubing, sleeves, slots, underfloor raceways, cellular floors, surface raceways, lighting fixture raceways, wireways, cable troughs, busways, auxiliary gutters and ventilated flexible cableways. Synonym: *Pathway*.
- Rack:** See: *Cable Rack*.
- Radio Frequency:** The frequencies in the electromagnetic spectrum that are used for radio communications.
- Random Winding:** A winding in rotating equipment wherein the wires do not lie in an even pattern.
- Reactance:** The opposition offered to the flow of alternating current by inductance or capacitance of a compound or circuit.
- Red Plaque:** A powdery, brown-red growth found on silvercoated copper conductors and shield braids.
- Redraw:** The consecutive drawing of wire through a series of dies to reach a desired wire size.
- Reducing Joint:** A joint between two lengths of cable where the conductors are not the same size.
- Reel:** A revoluble flanged device made of wood or metal, used for winding flexible metal wire or cable.
- Reflection:** (fiber optic) Change in direction of a light wave or ray.
- Reflection Loss:** The part of a signal which is lost due to reflection of power at a line discontinuity.
- Refraction:** (fiber optic) The bending of lightwaves or rays as they go from one material to another due to the difference in velocities in the materials.
- Reinforced Sheath:** The outermost covering of a cable that has cable sheath constructed in layers with the addition of a reinforcing material, usually a braided fiber, molded in place between layers.
- Remanence:** The magnetic induction that remains in a magnetic circuit after the removal of an applied magnetomotive force.
- Repeater:** A device which consists of a transmitter and a receiver or transmitter, used to regenerate a signal to increase the system transmission length.
- Resistance:** A measure of the difficulty in moving electrical current through a medium when voltage is applied. It is measured in Ω .
- Resistive Conductor:** A conductor with high electric resistance.
- Retractile Cord:** A cord having specially treated insulation or jacket so that it will retract.
- Return Wire:** A ground wire or the negative wire in a direct-current circuit.
- Ribbon Cable:** A flat cable of individually insulated conductors lying parallel and held together by means of adhesive or woven textile yarn.
- Ridge Marker:** One or more ridges running laterally along the outer surface of a plastic-insulated wire for purposes of identification.
- Rigid Bay:** Cabling equipment that maintains component sequence, and can produce cables with distinct layers.
- Rigid Coaxial Cable:** Nonflexible coaxial cable, usually a metal tube armored coaxial cable.
- Ring Tongue:** A solderless terminal that connects wire to a stud.
- Ringing Out:** Locating or identifying specific conductive paths by passing current through selected conductors.
- Rip-Cord:** 1.) Two or more insulated conductors in a parallel configuration which may be separated to leave the insulation of each conductor intact. 2.) A small filament cord used to rip through the outer cable sheath.
- RoHS (Restriction on Hazardous Substances):** European Union directive that restricts use of heavy metal substances.
- Rope Concentric:** A group of standard conductors assembled in a concentric manner.
- Rope Lay Conductor:** A conductor composed of a central core surrounded by one or more layers of helically laid groups of wires.
- Rope Unilay:** A group of stranded conductors assembled in a unilay manner.
- Round Wire Shields:** Shields constructed from bare, tinned or silver-plated copper wire that include braided, spiral and reverse spiral.
- Routers:** A device that determines how to forward a packet toward its destination, based on tables that indicate the costs, congestion status and other factors associated with possible routes. Also called a level 3 relay or an intermediate system.
- Rubber (Wire Insulation):** Term used to describe wire insulations made of thermosetting elastomers; occurs naturally or may be made synthetically.
- Rulan®:** DuPont's trade name for their flame-retardant polyethylene insulating material.
- Screen:** A shield placed over the entire core.
- Secondary Insulation:** A nonconductive material that protects the conductor against abrasion and provides a second electrical barrier.
- Segmental Conductor:** A stranded conductor consisting of three or more stranded conducting elements, each element having approximately the shape of the sector of a circle, assembled to give a substantially circular cross-section.
- Selenium Cure:** Process used to cure neoprene and rubber jacketed wires and cables.
- Self-Extinguishing:** Characteristic of a material whose flame is extinguished after the igniting flame source is removed.
- Semi-Conducting Jacket:** A jacket having a sufficiently low resistance so that its outer surface can be kept at substantially ground potential.
- Semi-Rigid:** A cable containing a flexible inner core and a relatively inflexible sheathing.
- Semi-Solid:** An insulation cross-section having a partially open space between the conductor and the insulation perimeter.
- Separator:** A layer of insulating material which is placed between a conductor and its dielectric between a cable jacket and the components it covers, or between various components of a multiple-conductor cable.
- Series Circuit:** A circuit in which the components are arranged end to end to form a single path for current.
- Serve:** A filament or group of filaments such as fibers or wires, wound around a central core.
- Serving:** A wrapping applied over the core of a cable or over a wire.
- Sheath:** See *Cable Sheath*.
- Shield:** In cables, a metallic layer placed around a conductor or group of conductors to prevent electrostatic or electromagnetic interference between the enclosed wires or external fields.
- Shield Coverage:** Amount of outer cable covered by the shielding material.
- Shield Effectiveness:** The ability of a shield to screen out undesirable signals.
- Shielded Line:** A transmission line whose elements confine propagated radio waves to an essentially finite space inside a tabular conducting surface called the sheath, thus preventing the line from radiating radio waves.
- Shielded-Type Cable:** A cable in which the surface of the insulation is at ground potential.
- Shunt Wire:** A conductor joining two parts of an electric circuit to divert part of the current.
- Signal:** A current used to convey information, either digital, analog, audio or video.
- Silicone:** A material made from silicon and oxygen. Can be in thermosetting elastomer or liquid form. The thermosetting elastomer form is noted for high heat resistance.
- Silicone Treating:** A silicone liquid treatment applied to insulated conductors to allow for easy jacket stripping.
- Sine Wave:** A wave that can be expressed as the sine of a linear function of time, or space or both.
- Single-ended:** Unbalanced, such as grounding one side of a circuit or transmission line.
- Single-Faced Tape:** Fabric tape finished on one side with a rubber or synthetic compound.
- Singlemode Fiber:** A fiber wave guide in which only one mode will propagate. The fiber has a very small core diameter of approximately 8mm. It permits signal transmission at extremely high bandwidths and is generally used with laser diodes.

Glossary

Sizing: Applying a material to a surface to fill pores.

Skeleton Braid: Widely separated braid of fiber copper or steel, used to hold core together, for reinforcing jacket or for shielding.

Skew Rays: A ray that does not intersect the fiber axis. Generally, a light ray that enters the fiber core at a very high angle.

Skim Tape: Filled tape coated on one or both sides with a thin film of uncured rubber or synthetic compound to produce a coating suitable for vulcanization.

Skin Effect: The tendency of alternating current, as its frequency increases, to travel only on the surface of a conductor.

Sleeve: A braided, knitted or woven tube used over wires or components as insulation tubing. Also called *Sleeving*.

Solid Conductor: A conductor consisting of a single wire.

Source Coupling Loss: (fiber optic) Loss of light intensity as light from source passes into fiber.

Space, Telecommunications: An area used for housing the installation and termination of telecommunications equipment and cable, e.g. telecommunications closets, work areas and manhole/handholes.

Span: (1.) In flat conductors, distance between the reference edge of the first and the last conductor. (2.) In round conductors, distance between centers of the first and last conductors. (3.) In aerial cable, the distance between poles or support clamps.

Spark Test: A test designed to locate pin-holes in the insulation of a wire or cable by application of a voltage for a very short period of time while the wire is being drawn through the electrode field.

Specific Gravity: The ratio of the density (mass per unit volume) of a material to that of water.

Spectral Bandwidth: The difference between wavelengths at which the radiant intensity of illumination is half its peak intensity.

Spectral Response: (fiber optic) The response of a detector (or a system) over different wavelengths.

Spectrum: Frequencies that exist in a continuous range and have a common characteristic.

Speed of Light (c): 2.998×10^8 meters per second.

Spiral Shield: A metallic shield of fine-stranded wires applied spirally rather than braided.

Spiral Stripe: A color-coding stripe applied helically to the surface of an insulated wire or cable.

Spiral Wrap: The helical wrap of a tape or thread over a core.

Splice: A joining of conductors, generally from separate sheaths.

Splice Closure: A device used to protect a cable or wire splice.

Spread Spectrum: A modulation technique for multiple access, or for increasing immunity to noise and interference.

Standing Wave: The stationary pattern of waves produced by two waves of the same frequency traveling in opposite directions on the same transmission line.

Standing Wave Ratio (SWR): In a transmission line, waveguide, or analogous system, a figure of merit used to express the efficiency of the system in transmitting power.

Star Topology: A topology in which each telecommunications outlet/connector is directly cabled to the distribution device.

Stay Cord: A component of a cable used to anchor the cable ends at their points of termination and to keep any pull of the cable from being transferred to the electrical connections.

Step Index Fiber: (fiber optic) A multimode fiber consisting of a core of uniform refractive index surrounded by cladding of slightly lower refractive index.

Strand: One of the wires of any stranded conductor.

Strand Lay: The distance of advance of one strand of a spirally stranded conductor, in one turn, measured axially.

Stranded Conductor: A conductor composed of groups of wires twisted together.

Strap: Square- or rectangular-section bare conductor manufactured and used in coil form.

Strip: To remove insulation from a cable.

Structural Return Loss: Backward reflected energies from uneven parts of the cable structure causing impedance variations are termed structural return loss.

Surface Resistivity: The resistance of a material between two opposite sides of a unit square of its surface. It is usually expressed in Ω .

Surge: A temporary and relatively large increase in the voltage or current in an electric circuit or cable. Also called *Transient*.

Suspended Ceiling: See *False Ceiling*.

Sweep-test: Pertaining to cable, the frequency response is verified by generating an rf voltage whose frequency is swept repeatedly through a given frequency range at a rapid constant rate while the cable response is observed.

Take-Up: The process of accumulating wire or cable onto a reel, bobbin or some other type of pack. Also, the device for pulling wire or cable through a piece of equipment or machine.

Tank Test: A voltage dielectric test in which the test sample is submerged in water and voltage is applied between the conductor and water as ground.

Tape: A relatively narrow woven or cut strip of fabric, paper or film material.

Tape Cable: A form of multiple conductor consisting of parallel metal strips imbedded in insulating material.

Tape Wrap: A spirally applied tape over an insulated or uninsulated wire.

Taped Insulation: Insulation of helically wound tapes applied over a conductor or over an assembled group of insulated conductors.

Taping: Process of insulating continuous length, large diameter wires with tape of non-extrudable materials.

TB: Terminal Block

Tear Strength: The force required to initiate or continue a tear in a material under specified conditions.

Teflon®: DuPont company trade name for fluorocarbon resins. FEP, PFA and TFE are typical materials.

Tefzel®: DuPont trade name for a fluorocarbon material typically used as a wire wrap insulation.

Telecommunications: The communication of information over some distance, including interbuilding and intrabuilding distances.

Telecommunications Closet: See *Closet, Telecommunications*.

Telecommunications Entrance Facility: See *Entrance Facility, Telecommunications*.

Telecommunications Entrance Point: See *Entrance Point, Telecommunications*.

Telecommunications Entrance Room or Space: See *Entrance Room or Space, Telecommunications*.

Telecommunications Equipment Room: See *Equipment Room, Telecommunications*.

Telecommunications Grounding Busbar: A common point of connection for telecommunications system and bonding to ground, which is located in the telecommunications closet or equipment room.

Telecommunications Infrastructure: See *Infrastructure, Telecommunications*.

Telecommunications Outlet/Connector: See *Outlet/Connector, Telecommunications*.

Telemetry Cable: Cable used for transmission of information from instruments to the peripheral recording equipment.

Temperature Rating: The maximum temperature at which an insulating material may be used in continuous operation without loss of its basic properties.

Tensile Strength: The pull stress required to break a given specimen.

Tension Member: A member included in a fiber cable to add tensile strength.

Terminal: (1) A point at which information may enter or leave a communications network; (2) the input-output associated equipment; or (3) a device by means of which wires may be connected to each other.

Termination Hardware: This term is outmoded. See *Connecting Hardware*.

Test Lead: A flexible, insulated lead wire used for making tests, connecting instruments to a circuit temporarily or for making temporary electrical connections.

Textile Braid: Any braid made from threads of cotton silk, or synthetic fibers.

Thermal Aging: Exposure to a thermal condition or programmed series of conditions for predescribed periods of time.

Thermocouple Lead Wire: An insulated pair of wires used from the couple to a junction box.

Thermoplastic: A material which softens when heated and becomes firm on cooling.

Thermoset: A material which hardens or sets when heat is applied, and which, once set, cannot be resoftened by heating. The application of heat is called "curing."

Three-Phase Current: Current delivered through three wires, with each wire serving as a return for the other two.

Three-Phase Three-Wire System: An alternating current supply system comprising three conductors over which three-phase power is sent.

Three-Wire System: A d-c or single-phase a-c system comprising three conductors, one of which is maintained at a potential midway between the potential of the other two.

Tin Overcoat (TOC): Tinned copper wire, stranded, then coated with pure tin.

Glossary

- Tinsel Wire:** A low-voltage stranded wire, with each strand a very thin conductor ribbon spirally wrapped around a textile yarn.
- Topcoat:** Bare (untinned) copper wire, stranded then coated with pure tin.
- Topology:** The physical or logical arrangement of a telecommunications system.
- Tracer:** A means of identifying polarity.
- Transducer:** A device for converting mechanical energy to electrical energy.
- Transfer Impedance:** The ratio of the source voltage of the wires inside the cable to the shield current of the cable or connectorized cable assembly.
- Transition Point:** A location in the horizontal cabling where flat undercarpet cable connects to round cable.
- Transmission:** Transfer of electric energy from one location to another through conductors or by radiation or induction fields.
- Transmission Cable:** Two or more transmission lines. See *Transmission Line*.
- Transmission Line:** An arrangement of two or more conductors or a wave guide used to transfer signal energy from one location to another.
- Transmission Loss:** The decrease or loss in power during transmission of energy from one point to another. Usually expressed in decibels.
- Transmission Media:** The various types of wire and optical fiber cable used for transmitting voice or data signals. Typically, wire cable includes twisted pair, coaxial and twinaxial. Optical fiber cable includes single, dual, quad, stranded and ribbon (AI).
- Transmitter:** The electronic package that injects an electrical signal or light signal over the transmission medium.
- Transparent:** (fiber optic) Transmitting rays of light so that objects can be seen through the material.
- Transposition:** Interchanging the relative positions of wires to neutralize the effects of induction to or from other circuits or, to minimize interference pickup by the lead-in during reception.
- Tray Cable:** A factory-assembled multiconductor or multipair control cable approved under the National Electrical Code for installation in trays.
- Triaxial:** A three-conductor cable with one conductor in the center, a second circular conductor shield concentric with the first, and third circular conductor shield insulated from and concentric with the first and second, usually with insulation, and over a braid or impervious sheath overall.
- Triboelectric Noise:** Noise generated in a shielded cable due to variations in capacitance between shielding and conductor as the cable is flexed.
- Triple Cable:** A cable composed of three insulated single conductors and one bare conductor, all twisted together. It may or may not have a common covering of binding.
- True Concentric:** A cable in which each successive layer has a reversed direction of lay from the preceding layer.
- Trunk Cable:** See *Feeder Cable*.
- Tubing:** A tube of extruded non-supported plastic material.
- Twin Cable:** A pair of insulated conductors twisted, sheathed or held together mechanically and not identifiable from each other in a common covering.
- Twin Coaxial:** A configuration containing two separate, complete coaxial cables laid parallel or twisted around each other in one complex.
- Twin Line:** A transmission line which has a solid insulating material, in which the two conductors are placed in parallel to each other.
- Twinner:** A device for twisting together two conductors.
- Twisted Pairs:** A cable composed of two small insulated conductors twisted together without a common covering.
- Unbalanced Line:** A transmission line in which voltages on the two conductors are unequal with respect to ground.
- Unidirectional Concentric Stranding:** A stranding where each successive layer has a different lay length, thereby retaining a circular form without migration of strands from one layer to another.
- Unidirectional Stranding:** A term denoting that in a stranded conductor, all layers have the same direction of lay.
- Unilay Strand:** A conductor constructed with a central core surrounded by more than one layer of helically-laid wires, with all layers having a common length and direction of lay.
- Velocity of Propagation (VP):** The speed of an electrical signal down a length of cable compared to speed in free space expressed as a percent. It is the reciprocal of the square root of the dielectric constant of the cable insulation.
- Volt:** A unit of electromotive force.
- Voltage:** The term most often used in place of electromotive force, potential difference or voltage drop to designate the electric pressure that exists between two points and is capable of producing a current when a closed circuit is connected between two points.
- Voltage Drop:** The voltage developed across a component or conductor by the current in the resistance or impedance of the component or conductor.
- Voltage Rating:** The highest voltage that may be continuously applied to a wire in conformance with standards or specifications.
- Voltage Standing Wave Ratio (VSWR):** The ratio of the maximum effective voltage to the minimum effective voltage measured along the length of a mis-matched radio frequency transmission line.
- Volume Resistivity (Specific Insulation Resistance):** The electrical resistance between opposite faces of a 1 cm. cube of insulating material, commonly expressed in Ω /centimeter.
- Vulcanization:** A chemical reaction in which the physical properties of an elastomer are changed by reacting it with sulfur or other cross-linking agents.
- Wall Thickness:** The thickness of the applied insulation or jacket.
- Water Absorption:** A test to determine the water absorbed by a material after a given immersion period.
- Waterblocked Cable:** A cable constructed with no internal voids in order to allow no longitudinal water passage under a given pressure.
- Watt:** A unit of electric power.
- Wave Form:** A graphical representation of a varying quantity. Usually, time is represented on the horizontal axis, and the current or voltage value is represented on the vertical axis.
- Wave Length:** The distance, measured in the direction of propagation, of a repetitive electrical pulse or waveform between two successive points that are characterized by the same phase of vibration.
- Wicking:** The longitudinal flow of a liquid in a wire or cable due to capillary action.
- Wire:** A conductor, either bare or insulated.
- Wire and Cable Marker:** Device for identification marking of wire and cable.
- Wire and Cable Tying, Clamping, and Harnessing Devices:** Tying tapes, lacing cords and flexible sleeveings which are used for wire and cable bundling, harnessing and holding. Other devices include plastic ties or clamps, spiral-cut plastic tubing and plastic U-shaped trays or ducts.
- Wire and Lead Cutters:** Tools for cutting that range from plier-type cutters to semiautomatic or fully automatic machines integrated with other wire processing operations such as stripping, forming and terminating.
- Wire Gauge:** A system of numerical designation of wire sizes.
- Wire Nut:** A closed-end splice that is screwed on instead of crimped.
- Wire Wrapped Connection:** A solderless connection made by wrapping bare wire around a square or rectangular terminal with a power or hand tool.
- Wire Wrapping Tools:** Portable electric tools and automatic stationary machines used to make solderless wrapped connections of wires to terminals.
- Wiring Closet:** See *Telecommunications Closet*.
- Work Area (Work Station):** A building space where the occupants interact with telecommunications terminal equipment.
- Wrapper:** An insulating barrier applied as a sheet or tape wrapped around a coil periphery.
- Yield Strength:** The minimum stress at which a material will start to physically deform without increase in load.
- Zytel®:** DuPont's trade name for nylon resins.

Sections of this glossary are reprinted with permission from December, 1985 Issue of ELECTRONICS copyright 1985. Lake Publishing Corporation, 17730 W. Peterson Rd., Libertyville, IL 60048-0159 USA. Permission to reprint granted to the General Cable Corporation. No additional reproduction of this wire and cable glossary allowed without written permission.

Abbreviations & Acronyms

A-D: Analog to digital conversion
ac: Alternating current
AC: Armored Cable, NEC Article 333 Cable Designation
ACO: Analog Central Office
ACR: Attenuation to Crosstalk Ratio
ADO: Auxiliary Disconnect Outlet
AER: Aerial
AF: Audio frequency
AIA: American Institute of Architects
ALPETH: An aerial telephone cable having an aluminum shield and polyethylene jacket
ALS: A type of cable consisting of insulated conductors enclosed in a continuous, closely fitting aluminum tube
ALVYNN: An indoor, riser rated telephone cable having an aluminum shield and vinyl jacket (PVC)
AM: Amplitude Modulation
ANSI: American National Standards Institute
ARPANET: Advanced Research Projects Agency Network
ASCII: American Standard Code for Information Interchange
ASME: American Society of Mechanical Engineers
ASP: A filled, direct burial telephone cable used in areas subject to rodent attack. It consists of a filled cable core, corrugated aluminum shield, corrugated steel tape, flooding compound and polyethylene jacket.
ASTA: United Kingdom approval agency
ASTM: American Society for Testing and Materials
AWG: American Wire Gauge
AWM: Appliance wiring material
B & S Gauge: See American Wire Gauge (AWG)
B or BUR: Buried
AWM: Appliance wiring material
BCF: Billion Conductor Feet
BEF: Building Entrance Facility
BER: Bit Error Rate
BIC: Building Industry Consultant
BICSI: Building Industry Consulting Service International
BISDN: Broadband Integrated Services Digital Network
BTU: British Thermal Unit
CA: Cable
CATV: (1) Community Antenna Television; Cable Access Television (2) CATV Cable, NEC Article 820 Cable Designation
CATVP: CATV Plenum Cable, NEC Article 820 Cable Designation
CATVR: CATV Riser Cable, NEC Article 820 Cable Designation
CATVX: CATV Limited Use Cable, NEC Article 820 Cable Designation
CB: Citizens band
C-C: Conductor to conductor capacitance
CCITT: The International Telegraph and Telephone Consultative Committee
CCTV: Closed-circuit television
CDDI: Copper Distributed Data Interface
CDF: Central Distribution Frame
CDO: Community Dial Office
CEBEC: Belgium approval agency; Commite Electrotechnique Belge Service de la Marque
CEE: European standards agency; International Commission on Rules for the Approval of Electrical Equipment

CEN: European Committee for Standardization
CENELEC: European Committee for Electrotechnical Standardization
CFC: Communications Flat Cable
ckt: Circuit
CLT or CLOS: Closet
CL2: Class 2 Circuit Cable, NEC Article 725 Cable Designation
CL2P: Class 2 Circuit Plenum Cable, NEC Article 725 Cable Designation
CL2R: Class 2 Circuit Riser Cable, NEC Article 725 Cable Designation
CL2X: Class 2 Circuit Limited Use Cable, NEC Article 725 Cable Designation
CL3: Class 3 Circuit Cable, NEC Article 725 Cable Designation
CL3P: Class 3 Circuit Plenum Cable, NEC Article 725 Cable Designation
CL3R: Class 3 Circuit Riser Cable, NEC Article 725 Cable Designation
CL3X: Class 3 Circuit Limited Use Cable, NEC Article 725 Cable Designation
CM: Communications Cable, NEC Article 800 Cable Designation
CMA: Circular Mil Area
CMP: Communication Cable Plenum, NEC Article 800 Cable Designation
CMR: Communications Cable Riser, NEC Article 800 Cable Designation
CMX: Communications Limited Use Cable, NEC Article 800 Cable Designation
CO: Central Office
codect: Coder decoder
COE: Central Office Equipment
COS: Cooperation for Open Systems
COSINE: Cooperation for Open Systems Interconnection Network in Europe
COT: Central Office Terminal
CPC: Customer Premises Communication
CPE: (1) Chlorinated Polyethylene (2) Customer Premises Equipment or Customer Provided Equipment
CPU: Central Processing Unit
CRT: Cathode Ray Tube
CSMA/CD: Carrier Sense Multiple Access/ Collision Detection
CSPE: Chlorosulfonated Polyethylene
CTR: Certified Test Report
CV: Continuous vulcanization
D-A: Digital to analog conversion
DAF: Dedicated Access Facility
dB: Decibel
DBS: Direct Broadcast Satellite
dc: Direct current
DCE: Data Circuit-Terminating Equipment
DCO: Digital Central Office
DCR: Direct Current Resistance
DD: Distribution Designer or Distribution Device
DEMARC: Demarcation point
DEMKO: Approval agency of Denmark
DGM: Data Grade Medium
DISA: Defense Information Systems Agency (formerly DCA)
DISI: Directory Information Services Infrastructure
DIST: District
DRT: Plastic range and dryer cord (CSA)
DTE: Data Terminal Equipment
DVD: Digital Versatile Disc
DW: Distribution Wire

E: Symbol for voltage. Usually used to represent direct voltage or the effective (root-mean-square) value of an alternating voltage
EFTS: Electronic funds transfer system
EIA: Electronic Industries Association
EMF: Electromotive Force
EMI: Electromagnetic Interference
EMT: Electric Metallic Tubing
EP: Entrance point
EPDM: Ethylene-propylene-diene monomer rubber
EPOS: Electronic Point-Of-Sale
EPR: Ethylene-propylene rubber
ER: Equipment room
ESS: Electronic Switching System
ESTA: Australian approval agency; Electricity Trust of South Australia
ETPC: Electrolytic Tough Pitch Copper
ETV: Educational Television
E/W: Equipped With
EX or EXT: Extension
EXCH: Exchange
f: Frequency
FAA: Federal Aeronautics Administration
FCC: (1) Federal Communications Commission (2) Flat Conductor Cable, NEC Article 328 Cable Designation
FDDI: Fiber Distributed Data Interface
FDM: Frequency-Division Multiplexing
FDR: Feeder
FEP: Fluorinated ethylene propylene
FEXT: Far End Crosstalk
FI: Approval agency of Finland; Electrical Inspectorate
FIPS PUB: Federal Information Processing Standard Publication
FM: Frequency modulation
FOCIS: Fiber Optic Connector Intermateability Standard
FOTP: Fiber Optic Test Procedure
FOTS: Fiber Optics Transmission System
FPL: Power Limited Fire Protective Signaling Circuit Cable, NEC Article 760 Cable Designation
FPLP: Power Limited Fire Protective Signaling Circuit Plenum Cable, NEC Article 760 Cable Designation
FPLR: Power Limited Fire Protective Signaling Circuit Riser Cable, NEC Article 760 Cable Designation
FR-1: A flammability rating established by Underwriter's Laboratories for wires and cables that pass a specially designed vertical flame test
freq: Frequency
FRICC: Federal Research Internet Coordinating Committee (now FNC)
FRPE: Flame Retardant Polyethylene
ft: Foot
FTP: Fire Transfer Protocol
ga: Gauge
GHZ: Gigahertz
grd: Ground
GTO: Gas tube sign and oil-burner ignition cable. 5,000V-15,000V.
H: Designation for intensity of magnetic energy
hc: Handset combination (single-line telephone)
HC: Horizontal cross-connect
hck: Handset combination; key (six-button telephone)
HDPE: High Density Polyethylene
HF: High Frequency

Abbreviations & Acronyms

hh: Handhole

Hi-Pot: A test designed to determine the highest voltage that can be applied to a conductor without breaking through the insulation.

HPD: Rubber- and asbestos-insulated heater cord. No braid on individual conductors but with braid overall. Also made with neoprene insulation and no asbestos or PVC/NBC.

HPN: Two-conductor, neoprene-insulated heater cord. Parallel construction. For use in damp locations.

HSJ: Same as type HS but with #18, #16 and #14 conductors and differing thickness of jacket.

HVAC: Heating, ventilation and air conditioning

Hz: Hertz

i: Symbol used to designate current

IC: Intermediate cross-connect

ICEA: Insulated Cable Engineers Association

IDC: Insulation Displacement Connector

IEC: International Electrotechnical Commission

IEEE: Institute of Electrical and Electronics Engineers

IGS: Integrated Gas Spacer Cable, NEC Article 325 Cable Designation

IMSA: International Municipal Signal Association

in: Inch

IRSG: Internet Research Steering Group

IRTF: Internet Research Task Force

IS: International Standard

ISA: Instrument Society of America

ISDN: Integrated Services Digital Network

ISO: International Organization for Standardization

ISOC: Internet Society

ITCO: Independent Telephone Company

ITU-T: International Telecommunications Union - Telecommunications Standardization Section

IW (C): Inside Wiring (cable)

J: Joule

kcmil: One thousand circular mils

KEMA KEUR: Approval agency of the Netherlands

kft: An abbreviation for 1000 ft.

kHz: Kilohertz

Kilo: A numerical prefix denoting 1000 (10³)

km: Kilometer

KTS: Key Telephone Service

kV: Kilovolt

kVA: Kilovolt Ampere

kW: Kilowatt

LAN: Local Area Network

LASER: Light Amplification by Stimulated Emission of Radiation

LATA: Local Access Transport Area

lbf: Pound force

LBO: Line Buildout

LDPE: Low Density Polyethylene

LEC: Local Exchange Carrier

LED: Light-Emitting Diode

LLDPE: Linear Low Density Polyethylene

LOCA: Loss of Coolant Accident

locap: Low-capacitance, low-loss paired cable

MAC: Moves, Adds and Changes

MAP: Manufacturing Automation Protocol

MATV: Master Antenna Television

Mbps: Megabits per second

MC: (1) main cross-connect (2) Metal Clad Cable, NEC Article 334 Cable Designation

MCM: One thousand circular mils

MDF: Main Distribution Frame

MDPE: Medium Density Polyethylene

Meg or Mega: A numerical prefix denoting 1,000,000 (10⁶)

M/G: Motor/Generator Set

MH: Manhole

Mho: The unit of conductivity. The reciprocal of an ohm.

MHz: Megahertz

MI: Mineral Insulated Cable, NEC Article 330 Cable Designation

Micro: A numerical prefix denoting one-millionth (10⁶)

MIL STD: Military Standard

MILNET: Military Network

MLT: Multi-Level Threshold

mm: Millimeter

Modem: Modulator demodulator

MTT: Main Telephone Terminal

MTW: Machine Tool Wire

MV: Medium Voltage Cable, NEC Article 326 Cable Designation

MW: Radio hookup wire with polyvinyl insulation and plain or nylon jacket or braid, or shield, 1000V

N: Newton

NAIC: Network Applications and Information Center

NASA: National Aeronautics and Space Administration

NBR: Natural butadiene-acrylonitrile copolymer rubber

NBS: National Bureau of Standards (now NIST)

NEC: National Electrical Code

NEMA: National Electrical Manufacturers Association

NEMKO: Approval agency of Norway

NESC: National Electrical Safety Code

NEXT: Near End Crosstalk

nf: Nanofarad

NFPA: National Fire Protection Association

NI: Network Interface

NID: Network Interface Device

NIST: National Institute of Standards and Technology (formerly NBS)

NIU: Network Interface Unit

nm: Nanometer

NM & NMC: Non Metallic Sheathed Cable, NEC Article 336 Cable Designation

NPLF: Non Power-Limited Fire Protective Signaling Circuit Cable, NEC Article 760 Cable Designation

NPLFP: Non Power-Limited Fire Protective Signaling Circuit Plenum Cable, NEC Article 760 Cable Designation

NPLFR: Non Power-Limited Fire Protective Signaling Circuit Plenum Cable, NEC Article 760 Cable Designation

NRZ: Non Return to Zero

NRZI: Non Return to Zero Inverted

OC: Optical Carrier

ODC: Ozone Depleting Chemical

OP: Outside Plant

OPE: Outside Plant Engineer

OSHA: Occupational Safety and Health Administration

OSI: Open Systems Interconnection

OVE: Approval agency of West Germany; Oesterreichischer Verband fur Elektrotechnik

PABX: Private Automatic Branch Exchange

PAM: Pulse Amplitude Modulation

PAP: A commonly used term for air core (unfilled) direct burial telephone cable with a corrugated aluminum shield

PBX: Private Branch Exchange

PC: Personal Computer

PCB: Printed Circuit Board

P-FEP: General Cable proprietary dielectric material used in junction with FEP.

PCM: Pulse Code Modulation

PCP: A commonly used term for air core (unfilled) direct burial cable with a corrugated copper shield

PE: Polyethylene

pf: Picofarad

PFA: Polyfluoroalkoxy

PIC: A general term for any type of plastic insulated telephone cable

Pico: A numerical prefix denoting one-millionth of one-millionth (10⁻¹²)

PL: Private Lines

PLSJ: All-rubber, parallel-jacketed, two-conductor, light-duty cord for pendant or portable use in damp locations. 300V.

PLT: (1) Plant (2) Same as PLSJ except thermo-plastic insulation

PLTC: Power Limited Tray Cable, NEC Article 725 Cable Designation

PM: Phase Modulation

POI: Point Of Interface

POSJ: All-rubber, parallel, light duty rip-cord for use on lamps and small appliances, 300V, 60°C

POT: Thermoplastic, parallel, light duty rip-cord. 300V, 60°C to 105°C.

POTS: Plain Old Telephone Service (colloquial)

PP: Polypropylene

PR: Pair

PTFE: Polytetrafluoroethylene

PTSS: Passive Transmission Sub-System

PVC: Polyvinyl Chloride

PVDF: Polyvinylidene Fluoride

R: Symbol for resistance

R-F: Radio-frequency

RCDD: Registered Communication Distribution Designer

REA: Rural Electrification Administration

REP: Repair

RFQ: Request for Quote

RG/U: General utility grade military coaxial cable

RH: Relative humidity

RJ-45: A specific pin-point assignment for an eight position modular telecommunications connector.

RMS: (1) rack mount space (2) Root Mean Squares

RoHS: Restriction on Hazardous Substances

S: Heavy-duty, rubber-insulated portable cord. Stranded copper conductors with separator and individual rubber insulation. Two or more color-coded conductors cabled with filler, wrapped with separator and rubber jacketed overall, 600 Volts.

SAE: Society of Automotive Engineers

SANZ: Standards Association of New Zealand

SBR: Styrene Butadiene Rubber

ScTP: Screened Twisted Pair

SDN: Switched Digital Network

Abbreviations & Acronyms

- SE:** Service Entrance Cable, NEC Article 338 Cable Designation
- SEMKO:** Approval agency for Sweden
- SFTP:** Simple File Transfer Protocol
- SI:** System Internationale
- SJ:** Junior hard-service, rubber-insulated pendant or portable cord. Same construction as type S, but 300V. Jacket thickness different.
- SJO:** Same as SJ, but carolprene, oil-resistant compound outer jacket. Can also be made "water-resistant." 300V, 60°C.
- SJT:** Junior hard service thermoplastic or rubber-insulated conductors with overall thermoplastic jacket, 300V, 60°C to 105°C.
- SJTO:** Same as SJT but oil-resistant thermoplastic outer jacket. 60°C.
- SMTP:** Simple Mail Transfer Protocol
- SNA:** Systems Network Architecture
- SNM:** Shielded Non Metallic Sheathed Cable, NEC Article 337 Cable Designation
- SNMP:** Simple Network Management Protocol
- SNR:** Signal to Noise Ratio
- SO:** Hard-service cord, same construction as type S except oil-resistant carolprene jacket, 600V, 60° to 90°C.
- SONET:** Synchronous Optical Network
- SP-1:** All rubber, parallel-jacketed, two-conductor light-duty cord for pendant or portable use in damp locations. 300V.
- SP-2:** Same as SP-1, but heavier construction, with or without third conductor for grounding purposes. 300V.
- SP-3:** Same as SP-23, but heavier construction for refrigerators or room air conditioners. 300V.
- SPC:** Stored Program Control
- SPG:** Single Point Ground
- SPT-1:** Same as SP-1, except all-thermoplastic. 300V. With or without third conductor for grounding.
- SPT-2:** Same as SP-2, except all-thermoplastic. 300V. With or without third conductor for grounding.
- SPT-3:** Same as SP-3, except all-thermoplastic. 300V. With or without third conductor for grounding.
- SRD:** Portable range or dryer cable. Three or four rubber-insulated conductors with rubber or neoprene jacket, flat or round construction. 300V, 60°C.
- SRDT:** Same as SRD, except all-thermoplastic with a maximum temperature of 90°C.
- SRL:** Structural return loss
- ST:** Hard-service cord, jacketed, same as type S except all-plastic construction, 600V, 60°C to 105°C.
- STA:** Station
- STO:** Same as ST but with oil-resistant thermoplastic outer jacket. 600V, 60°C.
- STP:** Shielded twisted pair
- SV:** Vacuum cleaner cord, two or three-conductor, rubber-insulated. Overall rubber jacket. For light-duty in damp locations. 300V, 60°C.
- SVO:** Same as SV except carolprene jacket, 300V, 60°C.
- SVT:** Same as SV except all-plastic construction. With or without third conductor for grounding purposes only. 300V, 60°C to 90°C.
- SW:** Station Wire
- SWB:** Switchboard
- SWR:** Standing Wave Ratio
- SYS:** System
- TC:** (1) Power and Control Tray Cable, NEC Article 340 Cable Designation (2) Telecommunications Closet
- TCP:** Transmission Control Protocol
- TDM:** Time-Division Multiplexing
- TEL:** Telephone
- TELCO:** Telephone Company
- TERM:** Terminal or termination
- TEW:** Canadian Standard Association type appliance wires. Solid or stranded single conductor, plastic-insulated, 600V, 105°C.
- TF:** Fixture wire, thermoplastic-covered solid or seven strands. 60°C.
- TFE:** Tetrafluoroethylene
- TFF:** Same as TF but flexible stranding. 60°C.
- THHN:** 90°C, 600V nylon jacketed building wire
- THW:** Thermoplastic vinyl-insulated building wire. Flame-retardant, moisture- and heat-resistant. 75°C. Dry and wet locations.
- THWN:** Same as THW but with nylon jacket overall. 75°C.
- TIA:** Telecommunications Industry Association
- TOC:** Tin Overcoat
- TP:** Transport Protocol
- TP-PMD:** Twisted Pair-Physical Medium Dependent
- TPDDI:** Twisted Pair Distributed Data Interface
- TSB:** Telecommunications System Bulletin
- TT:** Telephone Terminal
- TTB:** Telephone Terminal Board
- TTY:** Text Telephones
- TW:** Thermoplastic vinyl-jacketed building wire, moisture-resistant. 60°C.
- UCC:** Uniform Code Council
- UF:** Thermoplastic underground feeder and branch circuit cable
- UF:** Underground Feeder and Branch Circuit Cable, NEC Article 339 Cable Designation
- UG:** Underground
- UHF:** Ultra High Frequency, 300 to 3,000 MHz
- UL:** Underwriter's Laboratories, Inc.
- µm:** Micron or micrometer
- UPC:** Universal Packaging Code
- UPS:** Uninterruptible Power Supply
- USE:** Underground Service Entrance Cable, NEC Article 338 Cable Designation
- UTE:** Approval agency for France; Union Technique de l'Electricite
- UTP:** Unshielded twisted-pair
- V:** Volt
- VDE:** West Germany approval agency
- VHF:** Very High Frequency, 30 to 300 MHz
- VP:** Velocity of Propagation
- VSWR:** Volume Standing Wave Ratio
- VW-1:** A flammability rating established by Underwriters Laboratories for wires and cables that pass a specially designed vertical flame test, (formerly designated FR-1)
- W:** Symbol for watt or wattage
- WA:** Work area
- WP:** Waterproof Outlet
- X:** Cross-connect
- XLPE:** Crosslinked polyethylene
- Z:** Symbol for impedance

Hook-Up Wire Product Finder

TEMP. °C	VOLTAGE	UL	UL	CSA	MIL	AWG	P/N	STRAND TYPE	PAGE
60	1500*	—	—	—	—	20	C1326	STRANDED	172
60	3000*	—	—	—	—	20	C1319	STRANDED	172
60	5000*	—	—	—	—	18	C1320A	STRANDED	172
60	5000*	—	—	—	—	18	C1321	STRANDED	172
60	10000*	—	—	—	—	18	C1318	STRANDED	172
80	1000	—	—	—	W-76B	24	C7600A	STRANDED	169
80	1000	—	—	—	W-76B	22	C7602A	STRANDED	169
80	1000	—	—	—	W-76B	20	C7604A	STRANDED	169
80	1000	—	—	—	W-76B	18	C7606A	STRANDED	169
80	1000	—	—	—	W-76B	16	C7608A	STRANDED	169
80	1000	—	—	—	W-76B	14	C7610A	STRANDED	169
80	1000	—	—	—	W-76B	12	C7611A	STRANDED	169
80/105	300	1007	1569	TR-64	—	24	C2003A	SOLID	167
80/105	300	1007	1569	TR-64	—	24	C2015A	STRANDED	167
80/105	300	1007	1569	TR-64	—	22	C2004A	SOLID	167
80/105	300	1007	1569	TR-64	—	22	C2016A	STRANDED	167
80/105	300	1007	1569	TR-64	—	20	C2028A	SOLID	167
80/105	300	1007	1569	TR-64	—	20	C2040A	STRANDED	167
80/105	300	1007	1569	TR-64	—	18	C2052A	SOLID	167
80/105	300	1007	1569	TR-64	—	18	C2064A	STRANDED	167
80/105	300	1007	1569	TR-64	—	16	C2053A	SOLID	167
80/105	300	1007	1569	TR-64	—	16	C2065A	STRANDED	167
105	600	1015	—	TEW	—	24	C2100A	STRANDED	168
105	600	1015	—	TEW	—	22	C2101A	STRANDED	168
105	600	1015	—	TEW	—	22	C2117A	SOLID	168
105	600	1015	—	TEW	—	20	C2102A	STRANDED	168
105	600	1015	—	TEW	—	20	C2118A	SOLID	168
105	600	1015	—	TEW	—	18	C2103A	STRANDED	168
105	600	1015	—	TEW	—	18	C2119A	SOLID	168
105	600	1015	—	TEW	—	16	C2104A	STRANDED	168
105	600	1015	—	TEW	—	14	C2105A	STRANDED	168
105	600	1015	—	TEW	—	12	C2106A	STRANDED	168
105	600	1015	—	TEW	—	10	C2107A	STRANDED	168

* For intermittent duty only

Multi-Conductor Cable Product Finder

NO. COND.	STRAND TYPE	AWG 28		AWG 24		AWG 22		AWG 20		AWG 19		AWG 18		AWG 16		AWG 14		AWG 12	
		P/N	SHIELD PAGE	P/N	SHIELD PAGE	P/N	SHIELD PAGE	P/N	SHIELD PAGE	P/N	SHIELD PAGE	P/N	SHIELD PAGE	P/N	SHIELD PAGE	P/N	SHIELD PAGE	P/N	SHIELD PAGE
2	SOLID					C2515A F.16 C4167A F.22 C2676A B.28 E1482S U.99 E2482S F.101 E3482S U-P.103 E3542S F-P.105 E1000S U.115 E2000S F.116 E3000S U-P.117 E2100S F-P.118	C4311A U.2	C2754A U.2			C3110 U-P.10 C3060 F-P.21 E2402S U.99 E1502S U.99 C4304A U.100 E2502S F.101 C4334A F.102 E3502S U-P.103 C3200 U-P.104 E3602S F-P.105 C3260 F-P.106 C0471 U.107 C0472 F.108 C3240 U-P.109 C3167 F-P.110 E1030S U.115 E2030S F.116 E3030S U-P.117 E2200S F-P.118			E2404S U.99 E1512S U.99 C4321A U.100 E2522S F.101 C4344A F.102 E3512S U-P.103 C3210 U-P.104 E3612S F-P.105 C3270 F-P.106 C0473 U.107 C0474 F.108 C3241 U-P.109 C3169 F-P.110		E2406S U.99 E1522S U.99 C4324A U.100 E2532S F.101 C4347A F.102 E3522S U-P.103 C3220 U-P.104 E3622S F-P.105 C3280 F-P.106 C0491 U.107 C0475 F.108 C3244 U-P.109 C3172 F-P.110		E1532S U.99 C4327A U.100 E2542S F.101 C4348A F.102 E3532S U-P.103 C3224 U-P.104 E3632S F-P.105 C3282 F-P.106 C0492 U.107 C0476 F.108 C3246 U-P.109 C3174 F-P.110	
	STRANDED	C6500A B.31	C2461A U.4 C2513A F.16 C4152A F.22 C4216A F.24 C0740A F.63	C6348A U.5 C3105 U-P.9 C3115 U-P.10 C4100A U.13 C0431A U.15 C2514A F.16 C2516A F.16 C2518A F.17 C2520A F.17 C3154 F-P.20 C3158 F-P.21 C4153A F.22 C4168A F.22 C4192A F.23 C4210A F.23 C0450A F.26 C2882A S.27 C2677A B.28 C2679A B.30 C6700A U.14 C0760A F.64 E1002S U.115 E2002S F.116 E3002S U-P.117 E2102S F-P.118 C6892A F.25 C6810A F.25	C6351A U.6 C4117A U.11 C0433A U.15 C2524A F.16 C2540A F.16 C2519A F.17 C3320 F-P.20 C4154A F.22 C4166A F.23 C4211A F.23 C0452A F.26 C2888A S.27 C2681A B.30 C3602 U-R.34 C1302 B-R.35 C6717A U.14 C0780A F.64 E1022S U.115 E2022S F.116 E3022S U-P.117 E2122S F-P.118 C6866A F.25 C6811A F.25			C2830A U.6 C3102 U-P.9 C3112 U-P.10 C4125A U.11 C4214A U.11 C0435A U.15 C2534A F.16 C2521A F.17 C3162 F-P.20 C3062 F-P.21 C4155A F.22 C4197A F.23 C4212A F.23 C0454A F.26 C2892A S.27 C2686A B.30 C1202 B-C.36, 165 C6725A U.14 C6714A U.14 E1032S U.115 E2032S F.116 E3032S U-P.117 E2202S F-P.118 C6897A F.25 C6812A F.25		C2405A U.7 C3193 U-P.9 C3127 U-P.10 C4135A U.12 C0437A U.15 C2536A F.16 C3169 F-P.20, 110 C3068 F-P.21 C4162A F.22 C4199A F.23 C4213A F.23 C0456A F.26 C2895A S.27 C2689A B.30 C8111 FB-P.33 C1602 B-C.36, 165 C6735A U.14 E1042S U.115 E2042S F.116 E3042S U-P.117 E2242S F-P.118 C6899A F.25 C6813A F.25	C2409A U.7 C3126 U-P.9 C3128 U-P.10 C4146A U.12 C0439A U.15 C2538A F.16 C4163A F.22 C4201A F.23 C4215A F.23 C0458A U.26 C6746A U.14 E1052S U.115 E2052S F.116 E3052S U-P.117 E2252S F-P.118 C6801A F.25 C6815A F.25	C2410A U.7 C3135 U-P.9 C3129 U-P.10 C4150A U.12 C0441A U.15 C2539A F.16 C4164A F.22 C4202A F.23 C0460A F.26 E1062S U.115 E2062S F.116 E3062S U-P.117 E2262S F-P.118							
3	SOLID					C4328A U.111						C3114 U-P.10 E1503S U.99 C4305A U.100 E2503S F.101 C4335A F.102 E3503S U-P.103 E3603S F-P.105	C4322A U.100 C4345A F.102	C4325A U.100					
	STRANDED	C6501A B.31 C0939A FB.65	C2462A U.4 C4217A F.24 C8115 FB-P.33 C0741A F.63 C0951A FB.65 C0680A FB.67	C4062A U.5 C4101A U.13 C0432A U.15 C2526A F.16 C2517A F.16 C3310 F-P.20 C4156A F.22 C4169A F.22 C4193A F.23 C0451A F.26 C1335A S.27 C2678A B.30 C6701A U.14 C0761A F.64 C0971A FB.66 E1003S U.115 E2003S F.116 E3003S U-P.117 E2103S F-P.118 C6893A F.25	C6352A U.6 C4118A U.11 C0434A U.15 C2528A F.16 C2525A F.16 C3321 F-P.20 C4157A F.22 C4158A F.22 C4195A F.23 C0453A F.26 C1643A B.29 C1332A B.30 C3603 U-R.34 C1304 B-R.35 C0781A F.64 E1023S U.115 E2023S F.116 E3023S U-P.117 E2123S F-P.118			C2831A U.6 C3190 U-P.9 C3120 U-P.10 C4126A U.11 C0436A U.15 C2535A F.16 C8106 F-P.19 C3164 F-P.20 C3064 F-P.21 C4159A F.22 C4198A F.23 C0455A F.26 C2768A S.27 C2687A B.30 C8107 FB-P.33 C1203 B-C.36 C6726A U.14 E1033S U.115 E2033S F.116 E3033S U-P.117 E2203S F-P.118 C6898A F.25		C2406A U.7 C3194 U-P.9 C4136A U.12 C0438A U.15 C2537A F.16 C3340 F-P.20 C4165A F.22 C4200A F.23 C0457A F.26 C8119 FB-P.33 C1603 B-C.36 C6736A U.14 E1043S U.115 E2043S F.116 E3043S U-P.117 E2243S F-P.118 C6800A F.25	C0440A U.15 C0459A F.26								

B - BRAID SHIELD
 C - CAROLPRENE®
 F - FOIL SHIELD
 FB - FOIL + BRAID SHIELD
 I - INDIVIDUAL FOIL SHIELD
 IFB - INDIVIDUAL FOIL + BRAID SHIELD
 P - PLENUM
 R - RUBBER
 S - SPIRAL SHIELD
 U - UNSHIELDED



Multi-Conductor Cable Product Finder

NO. COND.	STRAND TYPE	AWG 28		AWG 24		AWG 22		AWG 20		AWG 19		AWG 18		AWG 16		AWG 14		AWG 12	
		P/N SHIELD	PAGE	P/N SHIELD	PAGE	P/N SHIELD	PAGE	P/N SHIELD	PAGE	P/N SHIELD	PAGE	P/N SHIELD	PAGE	P/N SHIELD	PAGE	P/N SHIELD	PAGE	P/N SHIELD	PAGE
4	SOLID					E1484S U. 99 E2484S F. 101 E3484S U-P. 103 E1001S U. 115 E3001S U-P. 117						C3111 U-P. 10 C3061 F-P. 21 E1504S U. 99 C4306A U. 100 E2504S F. 101 C4346A F. 102 E3514S U-P. 103 C3211 U-P. 104 E3614S F-P. 105 C3201 U-P. 104 E3604S F-P. 105 C3261 F-P. 106 C0485 U. 107 C0494 F. 108 C3242 U-P. 109 C3170 F-P. 110	E1514S U. 99 C4323A U. 100 E2524S F. 101 C4346A F. 102 E3514S U-P. 103 C3211 U-P. 104 E3614S F-P. 105 C3271 F-P. 106 C0486 U. 107 C0495 F. 108 C3243 U-P. 109 C3171 F-P. 110	E1524S U. 99 C4326A U. 100 E2534S F. 101 E3524S U-P. 103 C3223 U-P. 104 E3624S F-P. 105 C3284 F-P. 106 C0496 F. 108 C3245 U-P. 109 C3173 F-P. 110	E1534S U. 99 E2544S F. 101 E3534S U-P. 103 C3225 U-P. 104 E3634S F-P. 105 C3283 F-P. 106 C0497 F. 108 C3247 U-P. 109 C3175 F-P. 110				
	STRANDED	C6502A B. 31 C0940A FB. 65	C2463A U. 4 C4218A F. 24 C0742A F. 63 C0952A FB. 65 C0681A FB. 67	C3159 F-P. 21 C4160A F. 22 C4194A F. 23 C1337A S. 27 C2680A B. 30 C6702A U. 14 C0762A F. 64 C0972A FB. 66 E1004S U. 115 E2004S F. 116 E3004S U-P. 117 E2104S F-P. 118 C4063A U. 5 C3106 U-P. 9 C3116 U-P. 10 C4102A U. 13 C2523A F. 16 C3155 F-P. 20 C6894A F. 25	C6353A U. 6 C4119A U. 11 C2555A F. 16 C3322 F-P. 20 C4161A F. 22 C4196A F. 23 C1644A B. 29 C2683A B. 30 C3604 U-R. 34 C1305 B-R. 35 C6718A U. 14 C0782A F. 64 E1024S U. 115 E2024S F. 116 E3024S U-P. 117 E2124S F-P. 118 C6896A F. 25		C2404A U. 6 C8102 U-P. 8 C3103 U-P. 9 C3113 U-P. 10 C4127A U. 11 C0444A U. 15 C2543A F. 18 C8114 F-P. 19 C3163 F-P. 20 C3063 F-P. 21 C4204A F. 23 C2668A B. 30 C8110 FB-P. 33 C1204 B-C. 36 C6727A U. 14 E1034S U. 115 E2034S F. 116 E3034S U-P. 117 E2204S F-P. 118 C6804A F. 25	C2425A U. 7 C3195 U-P. 9 C4137A U. 12 C3341 F-P. 20 C1604 B-C. 36 C6737A U. 14 E1044S U. 115 E2044S F. 116 E3044S U-P. 117 E2244S F-P. 118 C6837A F. 25	C2430A U. 7 C4147A U. 12 C6747A U. 14 E1054S U. 115 E2054S F. 116 E3054S U-P. 117 E2254S F-P. 118	C2440A U. 7 C4151A U. 12 E1064S U. 115 E2064S F. 116 E3064S U-P. 117 E2264S F-P. 118									
5	SOLID											C3117 U-P. 10 E1505S U. 99 C4307A U. 100 C4337A F. 102	C4349A U. 100 C4350A F. 102						
	STRANDED	C0941A FB. 65	C2464A U. 4 C4219A F. 24 C0753A F. 63 C0953A FB. 65 C0682A FB. 67	C4064A U. 5 C4103A U. 13 C0973A FB. 66	C6355A U. 6 C4120A U. 11 C1645A B. 29 C3605 U-R. 34 C1308 B-R. 35		C2420A U. 6 C3134 U-P. 9 C3125 U-P. 10 C4128A U. 11	C2434A U. 7 C4138A U. 12	C2437A U. 7 C4148A U. 12										
6	SOLID					E1486S U. 99 C4300A U. 100 C4329A U. 111						C3118 U-P. 10 E1506S U. 99 C4308A U. 100 E2506S F. 101 C4338A F. 102 E3506S U-P. 103 E3606S F-P. 105 C4333A U. 111							
	STRANDED	C6503A B. 31 C0942A FB. 65	C2466A U. 4 C4220A F. 24 C0743A F. 63 C0954A FB. 65 C0683A FB. 67	C4066A U. 5 C4104A U. 13 C3311 F-P. 20 C4207A F. 23 C1341A S. 27 C6704A U. 14 C0763A F. 64 C0974A FB. 66 E1006S U. 115 E2006S F. 116 E3006S U-P. 117 E2106S F-P. 118 C6807A F. 25	C1646A B. 29 C3606 U-R. 34 C1310 B-R. 35 C0783A F. 64		C3192 U-P. 9 C3121 U-P. 10 C4206A U. 11 C3166 F-P. 20 C3065 F-P. 21 C4205A F. 23 C8120 FB-P. 33 C1206 B-C. 36 C6706A U. 14 E1036S U. 115 E2036S F. 116 E3036S U-P. 117 E2206S F-P. 118 C6805A F. 25	C8108 FB-P. 33											
7	SOLID											C4309A U. 100 C4339A F. 102							
	STRANDED	C0943A FB. 65	C2488A U. 4 C4221A F. 24 C0754A F. 63 C0955A FB. 65 C0684A FB. 67	C4088A U. 5 C4105A U. 13 C0975A FB. 66	C6356A U. 6 C4121A U. 11 C3607 U-R. 34 C1312 B-R. 35		C2421A U. 6 C4129A U. 11	C2426A U. 7 C4139A U. 12	C2431A U. 7 C4149A U. 12										
8	SOLID											C3119 U-P. 10 E1508S U. 99 C4310A U. 100 E2508S F. 101 C4340A F. 102							
	STRANDED	C6504A B. 31 C0944A FB. 65	C2465A U. 4 C4222A F. 24 C0744A F. 63 C0956A FB. 65 C0685A FB. 67	C4065A U. 5 C4106A U. 13 C4208A F. 23 C0764A F. 64 C0976A FB. 66 E1008S U. 115 E2008S F. 116 E3008S U-P. 117 E2108S F-P. 118	C1648A FB. 32 C3608 U-R. 34 C1313 B-R. 35 C0784A F. 64		C3191 U-P. 9 C3122 U-P. 10 C3180 F-P. 20 E1038S U. 115 E2038S F. 116 E3038S U-P. 117 E2208S F-P. 118	C2443A U. 7 C4140A U. 12											



B - BRAID SHIELD
 C - CAROLPRENE®
 F - FOIL SHIELD
 FB - FOIL + BRAID SHIELD
 I - INDIVIDUAL FOIL SHIELD
 IFB - INDIVIDUAL FOIL + BRAID SHIELD
 P - PLENUM
 R - RUBBER
 S - SPIRAL SHIELD
 U - UNSHIELDED



Multi-Conductor Cable Product Finder

NO. COND.	STRAND TYPE	AWG 28		AWG 24		AWG 22		AWG 20		AWG 19		AWG 18		AWG 16		AWG 14		AWG 12			
		P/N	SHIELD PAGE	P/N	SHIELD PAGE	P/N	SHIELD PAGE	P/N	SHIELD PAGE	P/N	SHIELD PAGE	P/N	SHIELD PAGE	P/N	SHIELD PAGE	P/N	SHIELD PAGE	P/N	SHIELD PAGE	P/N	SHIELD PAGE
9	SOLID											C4312A U.100 C4341A F.102									
	STRANDED	C0945A FB.65		C2470A U.4 C4223A F.24 C0755A F.63 C0957A FB.65 C0686A FB.67		C4070A U.5 C4107A U.13 C0977A FB.66		C6357A U.6 C4122A U.11					C2422A U.6 C4130A U.11		C2435A U.7 C4141A U.12						
10	SOLID											C4313A U.100 C4342A F.102									
	STRANDED	C6505A B.31 C0946A FB.65		C2471A U.4 C4224A F.24 C0745A F.63 C0958A FB.65 C0687A FB.67		C4071A U.5 C4108A U.13 C0765A F.64 C0978A FB.66 E1010S U.115 E2010S F.116 E3010S U-P.117 E2110S F-P.118		C3610 U-R.34 C0785A F.64					C3178 U-P.9 C3123 U-P.10 C3181 F-P.20 C3183 F-P.21 E1040S U.115 E2040S F.116								
11	SOLID											C4314A U.100									
	STRANDED																				
12	SOLID					C4330A U.111															
	STRANDED	C6506A B.31		C2467A U.4		C4067A U.5 C4109A U.13 E1012S U.115 E2012S F.116 E3012S U-P.117 E2112S F-P.118		C6360A U.6 C4123A U.11					C2412A U.6 C3179 U-P.9 C3124 U-P.10 C4131A U.11 C3182 F-P.20 C3184 F-P.21 E1041S U.115 E2041S F.116		C2427A U.7 C4142A U.12						
15	SOLID					C4301A U.100 C4331A U.111															
	STRANDED	C6507A B.31 C0947A FB.65		C2473A U.4 C4225A F.24 C0746A F.63 C0959A FB.65 C0688A FB.67		C4073A U.5 C4110A U.13 C0766A F.64 C0979A FB.66 C4111A U.13		C6358A U.6 C4124A U.11 C0786A F.64					C2423A U.6 C4132A U.11		C2428A U.7 C4143A U.12						
19	SOLID											C2424A U.6									
	STRANDED											C4133A U.11		C2429A U.7 C4144A U.12							
20	SOLID					C4302A U.100						C4316A U.100									
	STRANDED	C6508A B.31		C4226A F.24 C0747A F.63 C0960A FB.65		C4075A U.5 C4112A U.13 C0767A F.64 C0980A FB.66															
21	SOLID											C4317A U.100									
	STRANDED																				
25	SOLID																				
	STRANDED	C0948A FB.65		C4227A F.24 C0748A F.63 C0961A FB.65		C4076A U.5 C4113A U.13 C0768A F.64 C0981A FB.66		C0787A F.64 C0788A F.64					C2433A U.6 C4134A U.11		C2436A U.7 C4145A U.12						
27	SOLID					C4332A U.111															
	STRANDED																				
30	SOLID											C4318A U.100 C4343A F.102									
	STRANDED			C4228A F.24 C0749A F.63		C4077A U.5 C4114A U.13															
40	SOLID																				
	STRANDED			C4229A F.24 C0750A F.63		C4078A U.5 C4115A U.13															
50	SOLID																				
	STRANDED			C4230A F.24 C0751A F.63		C4079A U.5 C4116A U.13															

Multi-Paired Cable Product Finder

NO. COND.	STRAND TYPE	AWG 28		AWG 24		AWG 22		AWG 20		AWG 18	
		P/N SHIELD	PAGE	P/N SHIELD	PAGE	P/N SHIELD	PAGE	P/N SHIELD	PAGE	P/N SHIELD	PAGE
2	SOLID					C4008A U	38				
	STRANDED			C8127 F-P	46	C7104A F	41			C6101A U	39
4	SOLID					C4010A U	38				
	STRANDED			C3150 F-P	43	C6010A U	38	C7106A I	53	C6118A U	39
6	SOLID					C4014A U	38				
	STRANDED			C3153 F-P	43	C6014A U	38	C6052A I	74	C6103A U	39
8	SOLID					C4015A U	38				
	STRANDED			C3151 F-P	43	C6015A U	38			C6119A U	39
9	SOLID										
	STRANDED			C3217 F-P	50						



B - BRAID SHIELD
 C - CAROLPRENE®
 F - FOIL SHIELD
 FB - FOIL + BRAID SHIELD
 I - INDIVIDUAL FOIL SHIELD
 P - PLENUM
 R - RUBBER
 S - SPIRAL SHIELD
 U - UNSHIELDED
 IFB - INDIVIDUAL FOIL + BRAID SHIELD



Multi-Paired Cable Product Finder

NO. COND.	STRAND TYPE	AWG 28		AWG 24		AWG 22		AWG 20		AWG 18	
		P/N SHIELD	PAGE	P/N SHIELD	PAGE	P/N SHIELD	PAGE	P/N SHIELD	PAGE	P/N SHIELD	PAGE
10	SOLID									C3120 U.....	10
	STRANDED			C4174A F.....48 C0604A F.....68 C0894A F.....69 C0623A FB.....70 C0832A FB.....72 C0518A FB.....73		C4187A F.....49 C0724A F.....68 C0653A FB.....70					
12	SOLID					C4017A U.....38 C1671A F.....41					
	STRANDED			C3165 F-P.....43 C4175A F.....48 C3218 F-P.....50 C3031 F-P.....51 C0605A F.....68 C0899A F.....69 C0624A FB.....70 C0839A FB.....72 C0519A FB.....73 C0606A I.....74 C0913A I.....75		C6017A U.....38 C3208 F-P.....43 C3356 F-P.....47 C4188A F.....49 C8133 I-P.....57 C8132 I-P.....58 C0573A I.....60 C0553A F.....61 C0725A F.....68 C0654A FB.....70 C6041A I.....74	C6053A I.....74		C6106A U.....39 C0587A I.....60 C0563A F.....61 C6048A I.....74		
14	SOLID										
	STRANDED			C4176A F.....48 C0606A F.....68 C0625A FB.....70 C0833A FB.....72 C0520A FB.....73		C0655A FB.....70					
16	SOLID										
	STRANDED			C4177A F.....48 C0607A F.....68 C0626A FB.....70 C0521A FB.....73		C0656A FB.....70				C6121A U.....	39
18	SOLID					C1672A F.....41					
	STRANDED			C4178A F.....48 C0608A F.....68 C0896A F.....69 C0607A I.....74 C0914A I.....75		C6019A U.....38 C4189A F.....49 C0574A I.....60 C0554A F.....61 C0726A F.....68 C6042A I.....74	C6054A I.....74		C6109A U.....39 C0588A I.....60 C0564A F.....61 C6049A I.....74		
20	SOLID										
	STRANDED			C4179A F.....48 C0609A F.....68 C0628A FB.....70 C0835A FB.....72 C0522A FB.....73		C0658A FB.....70					
22	SOLID										
	STRANDED				C0915A I.....75	C0575A I.....60 C0555A F.....61 C6043A I.....74				C0589A I.....	60
24	SOLID										
	STRANDED			C0836A FB.....72 C0916A I.....75		C6023A U.....38 C6059A I.....74	C6056A I.....74		C6050A I.....		74
25	SOLID										
	STRANDED			C3152 F-P.....43 C0897A F.....69 C0630A FB.....70 C0523A FB.....73		C0660A FB.....70					



B - BRAID SHIELD
 C - CAROLPRENE®
 F - FOIL SHIELD
 FB - FOIL + BRAID SHIELD
 I - INDIVIDUAL FOIL SHIELD

IFB - INDIVIDUAL FOIL + BRAID SHIELD
 P - PLENUM
 R - RUBBER
 S - SPIRAL SHIELD
 U - UNSHIELDED



Multi-Paired Cable Product Finder

NO. COND.	STRAND TYPE	AWG 28		AWG 24		AWG 22		AWG 20		AWG 18	
		P/N SHIELD	PAGE	P/N SHIELD	PAGE	P/N SHIELD	PAGE	P/N SHIELD	PAGE	P/N SHIELD	PAGE
30	SOLID					C1673A F.....	.41				
	STRANDED			C4180A F.....	.48	C6026A U.....	.38	C6058A I.....	.74	C6111A U.....	.39
				C0610A F.....	.68	C4190A F.....	.49			C0590A I.....	.60
				C0524A FB.....	.73	C0556A F.....	.61			C0566A F.....	.61
				C0917A I.....	.75	C0728A F.....	.68			C6051A I.....	.74
						C6044A I.....	.74				
34	SOLID										
	STRANDED					C6060A I.....	.74				
36	SOLID										
	STRANDED			C0525A FB.....	.73						
38	SOLID										
	STRANDED			C4181A F.....	.48	C0729A F.....	.68				
				C0611A F.....	.68	C6045A I.....	.74				
50	SOLID										
	STRANDED			C4182A F.....	.48	C0663A FB.....	.70				
				C0612A F.....	.68						
				C0526A FB.....	.73						
54	SOLID										
	STRANDED					C0730A F.....	.68				
						C6046A I.....	.74				
102	SOLID										
	STRANDED					C6451A F.....	.42				



B - BRAID SHIELD
 C - CAROLPRENE®
 F - FOIL SHIELD
 FB - FOIL + BRAID SHIELD
 I - INDIVIDUAL FOIL SHIELD

IFB - INDIVIDUAL FOIL + BRAID SHIELD
 P - PLENUM
 R - RUBBER
 S - SPIRAL SHIELD
 U - UNSHIELDED



NEC/CEC Substitution Chart

Communication wire and cable for premise installations in accordance with Article 800, and other applicable parts of the National Electrical Code (NEC), latest issue. Communication wire and cables for Canada are in accordance with the harmonized Canadian Standard Association C22.2 No. 214, Underwriters Laboratories UL 444, latest issue.

Figure 800-154(E) Cable Substitution Hierarchy

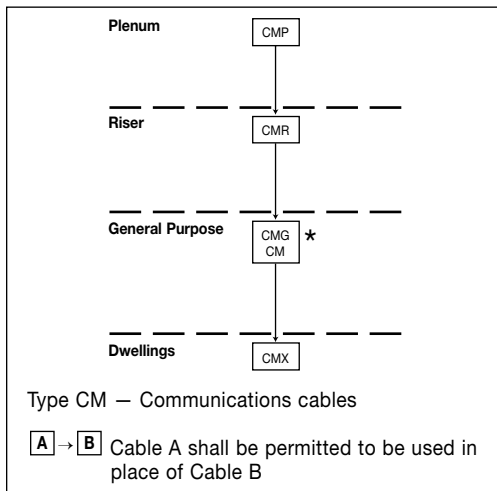

*CMG can be substituted for CM—CM can NOT be substituted for CMG

Figure 725-154(G), Cable Substitution Hierarchy

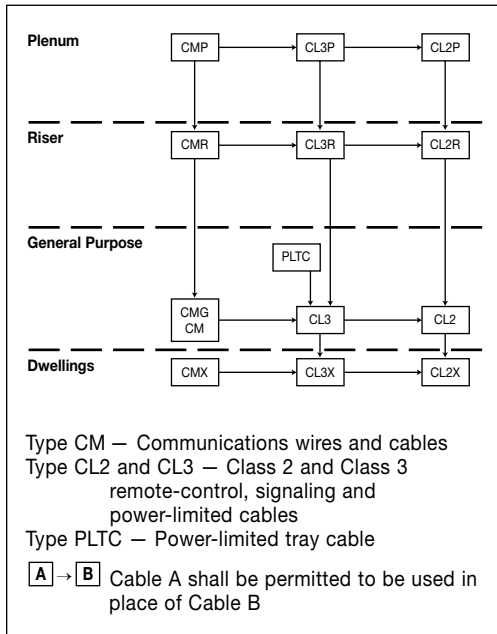

FIRE RESISTANCE LEVEL	TEST REQUIREMENT	NEC ARTICLE			
		800	725	760	820
(Highest) Plenum Cables	NFPA 262 (Steiner Tunnel) CSA-CMP (Steiner Tunnel)	CMP	CL3P CL2P	FPLP	CATVP
Riser Cables	UL-1666 (Vertical Shaft)	CMR	CL3R CL2R	FPLR	CATVR
General-Purpose Cables Multiple Floors	UL-1581 (Vertical Tray) CSA-CMG (Vertical Tray)	CMG CM	CL3	FPL	CATV
(Lowest) Residential Cables Restricted Use	UL-1581 VW-1	CMX	CL2 CL3X		CATVX

Notes: 1. Cables with a higher fire resistance level may be substituted for those with a lower fire resistance level.
2. Non-fire rated outside plant telephone cables may not run outside of a rigid metal conduit more than 50 feet from the point of entrance into a building.
3. Cables rated cmg or cm may be used in runs penetrating one floor. (nec 800-53)

ARTICLE 800

Table 800-154(E). Cable Uses and Permitted Substitutions

CABLE TYPE	USE	REFERENCE	PERMITTED SUBSTITUTIONS
CMP (FT6)	Communications plenum cable	800-154(a)	
CMR	Communications riser cable	800-154(b)	CMP
CMG (FT4) CM (FT1)	Communications general purpose cable	800-154(c)	CMP, CMR
CMX (FT1)	Communications cable, limited use	800-154(c)	CMP, CMR, CMG, CM

Note: See Figure 800-154(E), Cable Substitution Hierarchy

ARTICLE 725

Table 725-154(G). Cable Uses and Permitted Substitutions

CABLE TYPE	USE	REFERENCE	PERMITTED SUBSTITUTIONS
CL3P	Class 3 plenum cable	725-61(a)	CMP
CL2P	Class 2 plenum cable	725-61(b)	CMP, CL3P
CL3R	Class 3 riser cable	725-61(b)	CMP, CL3P, CMR
CL2R	Class 2 riser cable	725-6 (b)	CMP, CL3P, CL2P, CMR, CL3R
PLTC	Power-limited tray cable	725-61(c) and (d)	
CL3	Class 3 cable	725-61(b), (e) and (f)	CMP, CL3P, CMR, CL3R, CMG, CM, PLTC
CL2	Class 2 cable	725-61(b), (c) and (f)	CMP, CL3P, CL2P, CMR, CL3R, CL2R, CMG, CM, PLTC, CL3
CL3X	Class 3 cable, limited use	725-61(b) and (e)	CMP, CL3P, CMR, CL3R, CMG, CM, PLTC, CL3, CMX
CL2X	Class 2 cable, limited use	725-61(b) and (e)	CMP, CL3P, CL2P, CMR, CL3R, CL2R, CMG, CM, PLTC, CL3, CL2, CMX, CL3X

Note: See Figure 725-154(G), Cable Substitution Hierarchy

NEC/CEC Substitution Chart

Figure 760-154 (D), Cable Substitution Hierarchy

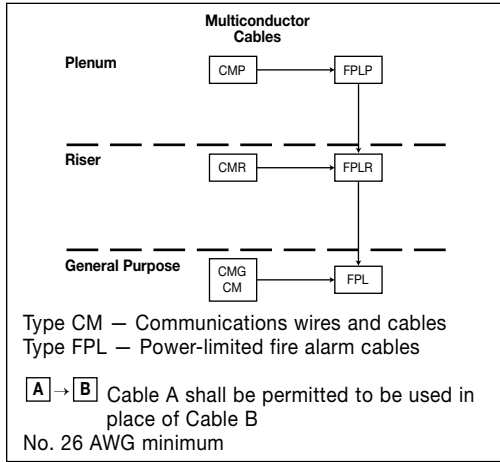

Article 760

Table 760-154 (D). Cable Uses and Permitted Substitutions

CABLE TYPE	USE	REFERENCES	PERMITTED SUBSTITUTIONS
			MULTICONDUCTOR
FPLP	Power-limited fire alarm plenum cable	760-154 (A)	CMP
FPLR	Power-limited fire alarm riser cable	760-154 (B)	CMP, FPLP, CMR
FPL	Power-limited fire alarm cable	760-154 (C)	CMP, FPLP, CMR, FPLR, CMG, CM

Note: See Figure 760-154 (D), Cable Substitution Hierarchy

Figure 820-154 (E), Cable Substitution Hierarchy

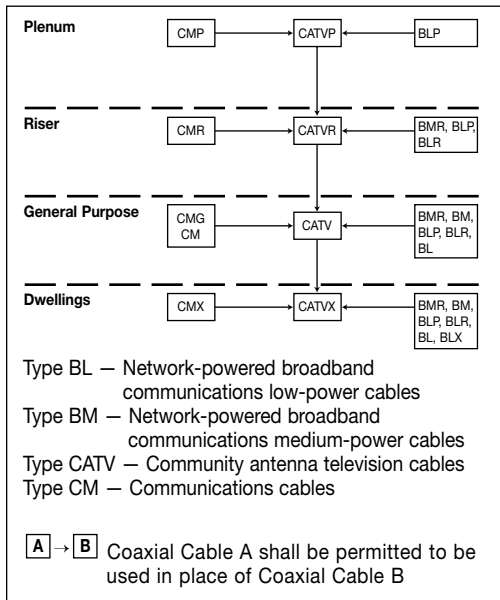

Article 820

Table 820-154 (E). Coaxial Cable Uses and Permitted Substitutions

CABLE TYPE	USE	REFERENCES	PERMITTED SUBSTITUTIONS
CATVP	Coaxial plenum cable	820-154 (A)	CMP, BLP
CATVR	Coaxial riser cable	820-154 (B)	CATVP, CMP, CMR, BMR, BLP, BLR
CATV	Coaxial general purpose cable	820-154 (C)	CATVP, CMP, CATVR, CMR, CMG, CM, BMR, BM, BLP, BLR, BL
CATVX	Coaxial cable, limited use	820-154 (C)	CATVP, CMP, CATVR, CMR, CATV, CMG, CM, BMR, BM, BLP, BLR, BL, BLX

Note: See Figure 820-154 (E), Cable Substitution Hierarchy

Agency Symbols



UL Listed Mark for the United States



CSA CMP



UL Listed Mark for Canada



CSA CMG



UL Listed Mark for Canada and the United States



CSA CMH



UL Recognized Component Mark for the United States

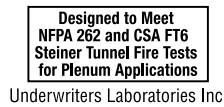

NFPA 262 and CSA FT6 Steiner Tunnel Fire Tests



TIA/EIA 568A Cat. 3

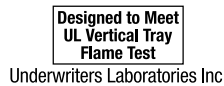

UL Vertical Tray Flame Test



TIA/EIA 568B Cat. 5e & Cat. 6



UL 1666 Riser Flame Test



California State Fire Marshal



IMSA



RoHS Compliant Directive 2011/65/EU



ETL

Put-Ups and Color Codes

PUT-UP CODES

	PULL-PAC®	SPOOL-PAC®	SPOOL	REEL
100'	-	-	12	33
250'	-	-	15	35
500'	25	-	18	38
1000'	30	86	21	41
2000'	-	-	-	43
2500'	-	-	24	44
3000'	-	-	-	52
5000'	-	-	26	46

JACKET COLOR CODES

COLOR	ABBREVIATION	COLOR CODE
Black	BK	01
White	WH	02
Red	RD	03
Orange	OR	04
Yellow	YL	05
Green	GN	06
Blue	BL	07
Brown	BR	08
Gray	GY	10
Pink	PK	13
Light Blue	LB	16
Beige	BG	17
Purple	PU	19
Natural	NT	86
Clear	CL	90

Due to variances in monitors and printed materials, the colors above are only a representation of color and do not necessarily reflect the actual jacket color of the cable.

Catalog Number Index

CATALOG NUMBER	PAGE	CATALOG NUMBER	PAGE	CATALOG NUMBER	PAGE	CATALOG NUMBER	PAGE
4EPL1S	113	23804.18.01	120	C0455A	26	C0604A	68
4EPL4S	113	23805.18.01	120	C0456A	26	C0605A	68
4ERS1S	114	23807.18.01	120	C0457A	26	C0606A	68
4ERS4S	114	23810.18.01	120	C0458A	26	C0607A	68
12/22LGRX	160	23815.60.01	120	C0459A	26	C0608A	68
16/18SVA	160	23817.60.01	120	C0460A	26	C0609A	68
16/18SVAP	160	23824.60.01	120	C0471	107	C0610A	68
18/22AXL	160	23825.60.01	120	C0472	108	C0611A	68
18/22AXLP	160	23827.60.01	120	C0473	107	C0612A	68
18/22CCD	160	61801EZ	159	C0474	108	C0620A	70
18/22CCQ	160	61801HS	159	C0475	108	C0621A	70
18/22CCT	160	72401EZ	159	C0476	108	C0622A	70
18/22CDC	160	76502	170	C0485	107	C0623A	70
18/22CRT	160	76512	170	C0486	107	C0624A	70
18/22CRTP	160	76812	170	C0491	107	C0625A	70
18/22GFE	160	76822	170	C0492	107	C0626A	70
18/22KYP	160	76832	170	C0494	108	C0628A	70
144NCAT	160	76843	170	C0495	108	C0630A	70
162VANT65	160	76954	171	C0496	108	C0650A	70
164LTCH	160	76994	171	C0497	108	C0651A	70
164NCAT	160	395011	136, 158	C0515A	73	C0652A	70
182LUTDS	160	395011-3	137	C0516A	73	C0653A	70
184LUTDS	160	395011-4	137	C0517A	73	C0654A	70
224SLTCH	160	395011-5	137	C0518A	73	C0655A	70
256VT9C5	158	395025	149	C0519A	73	C0656A	70
05091	121	395025-3	150	C0520A	73	C0658A	70
05092	121	395025-4	150	C0521A	73	C0660A	70
05093	121	395025-5	150	C0522A	73	C0663A	70
05094	121	395025-10	150	C0523A	73	C0680A	67
05095	121	395029	143, 158	C0524A	73	C0681A	67
05096	121	395035-3	151	C0525A	73	C0682A	67
05097	121	395035-4	151	C0526A	73	C0683A	67
05098	121	395035-5	151	C0550A	61	C0684A	67
05099	121	395058	143	C0551A	61	C0685A	67
05481	122	397001	139	C0552A	61	C0686A	67
05482	122	495015	143	C0553A	61	C0687A	67
05483	122	495016	143	C0554A	61	C0688A	67
05484	122	495023	149	C0555A	61	C0720A	68
05485	122	495025	136	C0556A	61	C0721A	68
05486	122	495027	143, 158	C0560A	61	C0722A	68
05487	122	495028	149, 158	C0561A	61	C0723A	68
05488	122	495035	136, 158	C0562A	61	C0724A	68
05489	122	495036	136	C0563A	61	C0725A	68
05581	122	497001	139	C0564A	61	C0726A	68
05582	122	C08###EMREFR	161	C0566A	61	C0728A	68
05583	122	C0431A	15	C0570A	60	C0729A	68
05584	122	C0432A	15	C0571A	60	C0730A	68
05585	122	C0433A	15	C0572A	60	C0740A	63
05586	122	C0434A	15	C0573A	60	C0741A	63
05587	122	C0435A	15	C0574A	60	C0742A	63
05588	122	C0436A	15	C0575A	60	C0743A	63
05589	122	C0437A	15	C0584A	60	C0744A	63
05782	123	C0438A	15	C0585A	60	C0745A	63
05783	123	C0439A	15	C0586A	60	C0746A	63
05784	123	C0440A	15	C0587A	60	C0747A	63
05785	123	C0441A	15	C0588A	60	C0748A	63
05786	123	C0444A	15	C0589A	60	C0749A	63
05788	123	C0450A	26	C0590A	60	C0750A	63
6604HS	159	C0451A	26	C0600A	68	C0751A	63
6606HS	159	C0452A	26	C0601A	68	C0753A	63
6608HS	159	C0453A	26	C0602A	68	C0754A	63
6612HS	159	C0454A	26	C0603A	68	C0755A	63

Catalog Number Index

CATALOG NUMBER	PAGE	CATALOG NUMBER	PAGE	CATALOG NUMBER	PAGE	CATALOG NUMBER	PAGE
C0760A	64	C0955A	65	C1345A	163	C2440A	7
C0761A	64	C0956A	65	C1350A	55	C2443A	7
C0762A	64	C0957A	65	C1352A	53	C2461A	4
C0763A	64	C0958A	65	C1353A	53	C2462A	4
C0764A	64	C0959A	65	C1602	36, 165	C2463A	4
C0765A	64	C0960A	65	C1603	36	C2464A	4
C0766A	64	C0961A	65	C1604	36	C2465A	4
C0767A	64	C0971A	66	C1642A	29	C2466A	4
C0768A	64	C0972A	66	C1643A	29	C2467A	4
C0780A	64	C0973A	66	C1644A	29	C2470A	4
C0781A	64	C0974A	66	C1645A	29	C2471A	4
C0782A	64	C0975A	66	C1646A	29	C2473A	4
C0783A	64	C0976A	66	C1648A	32	C2488A	4
C0784A	64	C0977A	66	C1670A	41	C2513A	16
C0785A	64	C0978A	66	C1671A	41	C2514A	16
C0786A	64	C0979A	66	C1672A	41	C2515A	16
C0787A	64	C0980A	66	C1673A	41	C2516A	16
C0788A	64	C0981A	66	C1676A	41	C2517A	16
C0829A	72	C1102	145	C2003A	167	C2518A	17
C0830A	72	C1103	145	C2004A	167	C2519A	17
C0831A	72	C1104	145	C2015A	167	C2520A	17
C0832A	72	C1106	145	C2016A	167	C2521A	17
C0833A	72	C1108A	138	C2028A	167	C2523A	16
C0835A	72	C1110	146	C2040A	167	C2524A	16
C0836A	72	C1135	145	C2052A	167	C2525A	16
C0839A	72	C1142	145, 158	C2053A	167	C2526A	16
C0841A	71	C1154	138	C2064A	167	C2528A	16
C0842A	71	C1155	144	C2065A	167	C2534A	16
C0843A	71	C1156	153	C2100A	168	C2535A	16
C0844A	71	C1160	140	C2101A	168	C2536A	16
C0890A	69	C1162	152	C2102A	168	C2537A	16
C0893A	69	C1164	152	C2103A	168	C2538A	16
C0894A	69	C1166	144	C2104A	168	C2539A	16
C0896A	69	C1176A	154	C2105A	168	C2540A	16
C0897A	69	C1180	138	C2106A	168	C2543A	18
C0899A	69	C1188	144	C2107A	168	C2555A	16
C0901A	69	C1198	138	C2117A	168	C2676A	28
C0910A	75	C1201	165	C2118A	168	C2677A	28
C0911A	75	C1202	36, 165	C2119A	168	C2678A	30
C0912A	75	C1203	36	C2404A	6	C2679A	30
C0913A	75	C1204	36	C2405A	7	C2680A	30
C0914A	75	C1206	36	C2406A	7	C2681A	30
C0915A	75	C1302	35	C2409A	7	C2683A	30
C0916A	75	C1304	35	C2410A	7	C2686A	30
C0917A	75	C1305	35	C2412A	6	C2687A	30
C0924A	76	C1308	35	C2420A	6	C2688A	30
C0925A	76	C1310	35	C2421A	6	C2689A	30
C0926A	76	C1312	35	C2422A	6	C2754A	2
C0939A	65	C1313	35	C2423A	6	C2768A	27
C0940A	65	C1318	172	C2424A	6	C2830A	6
C0941A	65	C1319	172	C2425A	7	C2831A	6
C0942A	65	C1320A	172	C2426A	7	C2882A	27
C0943A	65	C1321	172	C2427A	7	C2888A	27
C0944A	65	C1326	172	C2428A	7	C2892A	27
C0945A	65	C1331A	164	C2429A	7	C2895A	27
C0946A	65	C1332A	30	C2430A	7	C3028	51
C0947A	65	C1333A	163	C2431A	7	C3029	51
C0948A	65	C1335A	27	C2433A	6	C3030	51
C0951A	65	C1337A	27	C2434A	7	C3031	51
C0952A	65	C1340A	164	C2435A	7	C3060	21
C0953A	65	C1341A	27	C2436A	7	C3061	21
C0954A	65	C1343A	164	C2437A	7	C3062	21

Catalog Number Index

CATALOG NUMBER	PAGE	CATALOG NUMBER	PAGE	CATALOG NUMBER	PAGE	CATALOG NUMBER	PAGE
C3063	21	C3192	9	C3602	34	C4130A	11
C3064	21	C3193	9	C3603	34	C4131A	11
C3065	21	C3194	9	C3604	34	C4132A	11
C3068	21	C3195	9	C3605	34	C4133A	11
C3102	9	C3200	104	C3606	34	C4134A	11
C3103	9	C3201	104	C3607	34	C4135A	12
C3105	9	C3204	43	C3608	34	C4136A	12
C3106	9	C3205	43	C3610	34	C4137A	12
C3110	10	C3206	43	C4008A	38	C4138A	12
C3111	10	C3207	43	C4010A	38	C4139A	12
C3112	10	C3208	43	C4014A	38	C4140A	12
C3113	10	C3210	104	C4015A	38	C4141A	12
C3114	10	C3211	104	C4017A	38	C4142A	12
C3115	10	C3214	50	C4062A	5	C4143A	12
C3116	10	C3215	50	C4063A	5	C4144A	12
C3117	10	C3216	50	C4064A	5	C4145A	12
C3118	10	C3217	50	C4065A	5	C4146A	12
C3119	10	C3218	50	C4066A	5	C4147A	12
C3120	10	C3220	104	C4067A	5	C4148A	12
C3121	10	C3223	104	C4070A	5	C4149A	12
C3122	10	C3224	104	C4071A	5	C4150A	12
C3123	10	C3225	104	C4073A	5	C4151A	12
C3124	10	C3240	109	C4075A	5	C4152A	22
C3125	10	C3241	109	C4076A	5	C4153A	22
C3126	9	C3242	109	C4077A	5	C4154A	22
C3127	10	C3243	109	C4078A	5	C4155A	22
C3128	10	C3244	109	C4079A	5	C4156A	22
C3129	10	C3245	109	C4081A	3	C4157A	22
C3134	9	C3246	109	C4082A	3	C4158A	22
C3135	9	C3247	109	C4083A	3	C4159A	22
C3150	43	C3260	106	C4084A	3	C4160A	22
C3151	43	C3261	106	C4088A	5	C4161A	22
C3152	43	C3270	106	C4100A	13	C4162A	22
C3153	43	C3271	106	C4101A	13	C4163A	22
C3154	20	C3280	106	C4102A	13	C4164A	22
C3155	20	C3282	106	C4103A	13	C4165A	22
C3156	56	C3283	106	C4104A	13	C4166A	23
C3157	56	C3284	106	C4105A	13	C4167A	22
C3158	21	C3310	20	C4106A	13	C4168A	22
C3159	21	C3311	20	C4107A	13	C4169A	22
C3162	20	C3320	20	C4108A	13	C4170A	48
C3163	20	C3321	20	C4109A	13	C4171A	48
C3164	20	C3322	20	C4110A	13	C4172A	48
C3165	43	C3340	20	C4111A	13	C4173A	48
C3166	20	C3341	20	C4112A	13	C4174A	48
C3167	110	C3352	47	C4113A	13	C4175A	48
C3169	20	C3353	47	C4114A	13	C4176A	48
C3170	110	C3354	47	C4115A	13	C4177A	48
C3171	110	C3356	47	C4116A	13	C4178A	48
C3172	110	C3362	47	C4117A	11	C4179A	48
C3173	110	C3364	47	C4118A	11	C4180A	48
C3174	110	C3500	148	C4119A	11	C4181A	48
C3175	110	C3519	144	C4120A	11	C4182A	48
C3178	9	C3520	152	C4121A	11	C4183A	49
C3179	9	C3521	135	C4122A	11	C4184A	49
C3180	20	C3523	135	C4123A	11	C4185A	49
C3181	20	C3524	135, 158	C4124A	11	C4186A	49
C3182	20	C3525	135, 158	C4125A	11	C4187A	49
C3183	21	C3526	148	C4126A	11	C4188A	49
C3184	21	C3528	141	C4127A	11	C4189A	49
C3190	9	C3529	142, 158	C4128A	11	C4190A	49
C3191	9	C3531	136	C4129A	11	C4191A	48

Catalog Number Index

CATALOG NUMBER	PAGE	CATALOG NUMBER	PAGE	CATALOG NUMBER	PAGE	CATALOG NUMBER	PAGE
C4192A	23	C4326A	100	C6040A	74	C6736A	14
C4193A	23	C4327A	100	C6041A	74	C6737A	14
C4194A	23	C4328A	111	C6042A	74	C6746A	14
C4195A	23	C4329A	111	C6043A	74	C6747A	14
C4196A	23	C4330A	111	C6044A	74	C6800A	25
C4197A	23	C4331A	111	C6045A	74	C6801A	25
C4198A	23	C4332A	111	C6046A	74	C6804A	25
C4199A	23	C4333A	111	C6047A	74	C6805A	25
C4200A	23	C4334A	102	C6048A	74	C6807A	25
C4201A	23	C4335A	102	C6049A	74	C6810A	25
C4202A	23	C4336A	102	C6050A	74	C6811A	25
C4203A	54	C4337A	102	C6051A	74	C6812A	25
C4204A	23	C4338A	102	C6052A	74	C6813A	25
C4205A	23	C4339A	102	C6053A	74	C6815A	25
C4206A	11	C4340A	102	C6054A	74	C6837A	25
C4207A	23	C4341A	102	C6056A	74	C6866A	25
C4208A	23	C4342A	102	C6058A	74	C6892A	25
C4209A	48	C4343A	102	C6059A	74	C6893A	25
C4210A	23	C4344A	102	C6060A	74	C6894A	25
C4211A	23	C4345A	102	C6065A	74	C6896A	25
C4212A	23	C4346A	102	C6066A	74	C6897A	25
C4213A	23	C4347A	102	C6067A	74	C6898A	25
C4214A	11	C4348A	102	C6101A	39	C6899A	25
C4215A	23	C4349A	100	C6103A	39	C7102A	162
C4216A	24	C4350A	102	C6106A	39	C7104A	41
C4217A	24	C4408	119	C6109A	39	C7106A	53
C4218A	24	C4408ST	119	C6111A	39	C7108A	172
C4219A	24	C4410	119	C6118A	39	C7112A	61
C4220A	24	C4412	119	C6119A	39	C7114A	61
C4221A	24	C4412ST	119	C6120A	39	C7116A	61
C4222A	24	C4413	119	C6121A	39	C7600A	169
C4223A	24	C4841A	71	C6348A	5	C7602A	169
C4224A	24	C4842A	71	C6351A	6	C7604A	169
C4225A	24	C4843A	71	C6352A	6	C7606A	169
C4226A	24	C4844A	71	C6353A	6	C7608A	169
C4227A	24	C5025	140	C6355A	6	C7610A	169
C4228A	24	C5029	140	C6356A	6	C7611A	169
C4229A	24	C5034	140	C6357A	6	C8000	155
C4230A	24	C5039	141	C6358A	6	C8001	155
C4300A	100	C5043	142	C6360A	6	C8014	155
C4301A	100	C5044	141, 158	C6451A	42	C8025	146, 158
C4302A	100	C5760	132	C6500A	31	C8027	148
C4304A	100	C5761	132	C6501A	31	C8028	148, 158
C4305A	100	C5770	147	C6502A	31	C8029	135
C4306A	100	C5775	132	C6503A	31	C8030	158
C4307A	100	C5776	132	C6504A	31	C8031	135
C4308A	100	C5777	133	C6505A	31	C8101	44
C4309A	100	C5778	135	C6506A	31	C8102	8
C4310A	100	C5779	158	C6507A	31	C8103	44
C4311A	2	C5780	147	C6508A	31	C8104	44
C4312A	100	C5785	133	C6700A	14	C8105	57
C4313A	100	C5804	133	C6701A	14	C8106	19
C4314A	100	C5822	134	C6702A	14	C8107	33
C4315A	100	C5886	132, 158	C6704A	14	C8108	33
C4316A	100	C5889	133, 158	C6706A	14	C8109	44
C4317A	100	C6010A	38	C6714A	14	C8110	33
C4318A	100	C6014A	38	C6717A	14	C8111	33
C4321A	100	C6015A	38	C6718A	14	C8112	58
C4322A	100	C6017A	38	C6725A	14	C8113	46
C4323A	100	C6019A	38	C6726A	14	C8114	19
C4324A	100	C6023A	38	C6727A	14	C8115	33
C4325A	100	C6026A	38	C6735A	14	C8116	40

Catalog Number Index

CATALOG NUMBER	PAGE	CATALOG NUMBER	PAGE	CATALOG NUMBER	PAGE	CATALOG NUMBER	PAGE
C8117	52	C9023ZH	91	C9069A	87	C9128A	82
C8118	45	C9024A	81	C9070A	87	C9128ZH	92
C8119	33	C9024ZH	91	C9071A	87	C9129A	82
C8120	33	C9025A	81	C9072A	87	C9129ZH	92
C8122	40	C9025ZH	91	C9073A	87	C9130A	82
C8123	46	C9026A	81	C9074A	87	C9130ZH	92
C8124	46	C9026ZH	91	C9100A	82	C9131A	82
C8126	46	C9027A	81	C9100ZH	92	C9131ZH	92
C8127	46	C9027ZH	91	C9101A	82	C9132A	82
C8128	59	C9028A	81	C9101ZH	92	C9132ZH	92
C8129	52	C9028ZH	91	C9102A	82	C9133A	82
C8131	57	C9029A	81	C9102ZH	92	C9133ZH	92
C8132	58	C9029ZH	91	C9103A	82	C9134A	82
C8133	57	C9030A	81	C9103ZH	92	C9134ZH	92
C8134	57	C9030ZH	91	C9104A	82	C9135A	82
C9000A	81	C9031A	81	C9104ZH	92	C9135ZH	92
C9000ZH	91	C9031ZH	91	C9105A	82	C9136A	82
C9001A	81	C9032A	81	C9105ZH	92	C9136ZH	92
C9001ZH	91	C9032ZH	91	C9106A	82	C9137A	82
C9002A	81	C9033A	81	C9106ZH	92	C9137ZH	92
C9002ZH	91	C9033ZH	91	C9107A	82	C9138A	82
C9003A	81	C9034A	81	C9107ZH	92	C9138ZH	92
C9003ZH	91	C9034ZH	91	C9108A	82	C9139A	82
C9004A	81	C9035A	81	C9108ZH	92	C9139ZH	92
C9004ZH	91	C9035ZH	91	C9109A	82	C9140A	82
C9005A	81	C9036A	81	C9109ZH	92	C9140ZH	92
C9005ZH	91	C9036ZH	91	C9110A	82	C9141A	82
C9006A	81	C9037A	81	C9110ZH	92	C9141ZH	92
C9006ZH	91	C9037ZH	91	C9111A	82	C9142A	82
C9007A	81	C9038A	81	C9111ZH	92	C9142ZH	92
C9007ZH	91	C9038ZH	91	C9112A	82	C9143A	82
C9008A	81	C9039A	81	C9112ZH	92	C9143ZH	92
C9008ZH	91	C9039ZH	91	C9113A	82	C9144A	82
C9009A	81	C9040A	81	C9113ZH	92	C9144ZH	92
C9009ZH	91	C9040ZH	91	C9114A	82	C9145A	82
C9010A	81	C9041A	81	C9114ZH	92	C9145ZH	92
C9010ZH	91	C9041ZH	91	C9115A	82	C9146A	82
C9011A	81	C9042A	81	C9115ZH	92	C9146ZH	92
C9011ZH	91	C9042ZH	91	C9116A	82	C9147A	82
C9012A	81	C9043A	81	C9116ZH	92	C9147ZH	92
C9012ZH	91	C9043ZH	91	C9117A	82	C9148A	82
C9013A	81	C9044A	81	C9117ZH	92	C9148ZH	92
C9013ZH	91	C9044ZH	91	C9118A	82	C9158A	88
C9014A	81	C9045A	81	C9118ZH	92	C9159A	88
C9014ZH	91	C9045ZH	91	C9119A	82	C9160A	88
C9015A	81	C9046A	81	C9119ZH	92	C9161A	88
C9015ZH	91	C9046ZH	91	C9120A	82	C9162A	88
C9016A	81	C9047A	81	C9120ZH	92	C9163A	88
C9016ZH	91	C9047ZH	91	C9121A	82	C9164A	88
C9017A	81	C9048A	81	C9121ZH	92	C9165A	88
C9017ZH	91	C9048ZH	91	C9122A	82	C9166A	88
C9018A	81	C9058A	87	C9122ZH	92	C9167A	88
C9018ZH	91	C9059A	87	C9123A	82	C9168A	88
C9019A	81	C9060A	87	C9123ZH	92	C9169A	88
C9019ZH	91	C9061A	87	C9124A	82	C9170A	88
C9020A	81	C9062A	87	C9124ZH	92	C9171A	88
C9020ZH	91	C9063A	87	C9125A	82	C9172A	88
C9021A	81	C9064A	87	C9125ZH	92	C9173A	88
C9021ZH	91	C9065A	87	C9126A	82	C9174A	88
C9022A	81	C9066A	87	C9126ZH	92	C9175A	88
C9022ZH	91	C9067A	87	C9127A	82	C9200A	83
C9023A	81	C9068A	87	C9127ZH	92	C9200ZH	93

Catalog Number Index

CATALOG NUMBER	PAGE	CATALOG NUMBER	PAGE	CATALOG NUMBER	PAGE	CATALOG NUMBER	PAGE
C9201A	83	C9232A	83	C9306A	84	C9406A	85
C9201ZH	93	C9232ZH	93	C9306ZH	94	C9406ZH	95
C9202A	83	C9233A	83	C9307A	84	C9407A	85
C9202ZH	93	C9233ZH	93	C9307ZH	94	C9407ZH	95
C9203A	83	C9234A	83	C9308A	84	C9408A	85
C9203ZH	93	C9234ZH	93	C9308ZH	94	C9408ZH	95
C9204A	83	C9235A	83	C9309A	84	C9410A	85
C9204ZH	93	C9235ZH	93	C9309ZH	94	C9410ZH	95
C9205A	83	C9236A	83	C9310A	84	C9411A	85
C9205ZH	93	C9236ZH	93	C9310ZH	94	C9411ZH	95
C9206A	83	C9237A	83	C9311A	84	C9412A	85
C9206ZH	93	C9237ZH	93	C9311ZH	94	C9412ZH	95
C9207A	83	C9238A	83	C9312A	84	C9413A	85
C9207ZH	93	C9238ZH	93	C9312ZH	94	C9413ZH	95
C9208A	83	C9239A	83	C9313A	84	C9414A	85
C9208ZH	93	C9239ZH	93	C9313ZH	94	C9414ZH	95
C9209A	83	C9240A	83	C9314A	84	C9415A	85
C9209ZH	93	C9240ZH	93	C9314ZH	94	C9415ZH	95
C9210A	83	C9241A	83	C9315A	84	C9416A	85
C9210ZH	93	C9241ZH	93	C9315ZH	94	C9416ZH	95
C9211A	83	C9242A	83	C9316A	84	C9417A	85
C9211ZH	93	C9242ZH	93	C9316ZH	94	C9417ZH	95
C9212A	83	C9243A	83	C9317A	84	C9418A	85
C9212ZH	93	C9243ZH	93	C9317ZH	94	C9418ZH	95
C9213A	83	C9244A	83	C9318A	84	C9420A	85
C9213ZH	93	C9244ZH	93	C9318ZH	94	C9420ZH	95
C9214A	83	C9245A	83	C9319A	84	C9421A	85
C9214ZH	93	C9245ZH	93	C9319ZH	94	C9421ZH	95
C9215A	83	C9246A	83	C9320A	84	C9422A	85
C9215ZH	93	C9246ZH	93	C9320ZH	94	C9422ZH	95
C9216A	83	C9247A	83	C9321A	84	C9423A	85
C9216ZH	93	C9247ZH	93	C9321ZH	94	C9423ZH	95
C9217A	83	C9248A	83	C9322A	84	C9424A	85
C9217ZH	93	C9248ZH	93	C9322ZH	94	C9424ZH	95
C9218A	83	C9258A	89	C9323A	84	C9426A	85
C9218ZH	93	C9259A	89	C9323ZH	94	C9426ZH	95
C9219A	83	C9260A	89	C9324A	84	C9427A	85
C9219ZH	93	C9261A	89	C9324ZH	94	C9427ZH	95
C9220A	83	C9262A	89	C9325A	84	C9450ZH	95
C9220ZH	93	C9263A	89	C9325ZH	94	C9451ZH	95
C9221A	83	C9264A	89	C9326ZH	94	C9452ZH	95
C9221ZH	93	C9265A	89	C9327ZH	94	C9453ZH	95
C9222A	83	C9266A	89	C9328ZH	94	C9454ZH	95
C9222ZH	93	C9267A	89	C9329ZH	94	C9455ZH	95
C9223A	83	C9268A	89	C9330ZH	94	C9456ZH	95
C9223ZH	93	C9269A	89	C9331ZH	94	C9457ZH	95
C9224A	83	C9270A	89	C9332ZH	94	C9458ZH	95
C9224ZH	93	C9271A	89	C9333ZH	94	C9459ZH	95
C9225A	83	C9272A	89	C9334ZH	94	C9460ZH	95
C9225ZH	93	C9273A	89	C9335ZH	94	C9500A	86
C9226A	83	C9300A	84	C9400A	85	C9500ZH	96
C9226ZH	93	C9300ZH	94	C9400ZH	95	C9501A	86
C9227A	83	C9301A	84	C9401A	85	C9501ZH	96
C9227ZH	93	C9301ZH	94	C9401ZH	95	C9502A	86
C9228A	83	C9302A	84	C9402A	85	C9502ZH	96
C9228ZH	93	C9302ZH	94	C9402ZH	95	C9503A	86
C9229A	83	C9303A	84	C9403A	85	C9503ZH	96
C9229ZH	93	C9303ZH	94	C9403ZH	95	C9504A	86
C9230A	83	C9304A	84	C9404A	85	C9504ZH	96
C9230ZH	93	C9304ZH	94	C9404ZH	95	C9505A	86
C9231A	83	C9305A	84	C9405A	85	C9505ZH	96
C9231ZH	93	C9305ZH	94	C9405ZH	95	C9506A	86

Catalog Number Index

CATALOG NUMBER	PAGE	CATALOG NUMBER	PAGE	CATALOG NUMBER	PAGE	CATALOG NUMBER	PAGE
C9506ZH	96	CP5.30.02	125	DBRF200P	129	E1482S	99
C9507A	86	CP5.30.03	125	DBRF200R	128	E1484S	99
C9507ZH	96	CP5.30.05	125	DBRF240	129	E1486S	99
C9508A	86	CP5.30.06	125	DBRF240FL	129	E1502S	99
C9508ZH	96	CP5.30.07	125	DBRF240HF	129	E1503S	99
C9510A	86	CP5.30.10	125	DBRF240P	129	E1504S	99
C9510ZH	96	CP5.A3.02	125	DBRF240R	129	E1505S	99
C9511A	86	CP5.A3.03	125	DBRF300	130	E1506S	99
C9511ZH	96	CP5.A3.05	125	DBRF300FL	130	E1508S	99
C9512A	86	CP5.A3.06	125	DBRF300HF	130	E1512S	99
C9512ZH	96	CP5.A3.07	125	DBRF300P	130	E1514S	99
C9513A	86	CP5.A3.10	125	DBRF300R	130	E1522S	99
C9513ZH	96	CP6.30.02	124	DBRF400	130	E1524S	99
C9514A	86	CP6.30.03	124	DBRF400FL	131	E1532S	99
C9514ZH	96	CP6.30.05	124	DBRF400HF	131	E1534S	99
C9515A	86	CP6.30.06	124	DBRF400P	131	E1842S	158
C9515ZH	96	CP6.30.07	124	DBRF400R	131	E1843S	158
C9516A	86	CP6.30.10	124	DBRFR195R	128	E2000S	116
C9516ZH	96	CP6.A3.02	124	DLC122	160	E2002S	116
C9517A	86	CP6.A3.03	124	DLC124	160	E2003S	116
C9517ZH	96	CP6.A3.05	124	DLC222	160	E2004S	116
C9518A	86	CP6.A3.06	124	DLC224	160	E2006S	116
C9518ZH	96	CP6.A3.07	124	DS401	159	E2008S	116
C9520A	86	CP6.A3.10	124	DS401D	159	E2010S	116
C9521A	86	CR5.30.02	125	DS401TS	159	E2012S	116
C9521ZH	96	CR5.30.03	125	DS404	159	E2022S	116
C9522A	86	CR5.30.05	125	DS408	159	E2023S	116
C9522ZH	96	CR5.30.06	125	DS412	159	E2024S	116
C9523A	86	CR5.30.07	125	DS601	159	E2030S	116
C9523ZH	96	CR5.30.10	125	DS601D	159	E2032S	116
C9525A	86	CR5.A3.02	125	DS604	159	E2033S	116
C9525ZH	96	CR5.A3.03	125	DS608	159	E2034S	116
C9526A	86	CR5.A3.05	125	DS612	159	E2036S	116
C9526ZH	96	CR5.A3.06	125	DS616	159	E2038S	116
C9527A	86	CR5.A3.07	125	DS624	159	E2040S	116
C9527ZH	96	CR5.A3.10	125	E1000S	115	E2041S	116
C9528A	86	CR6.30.02	124	E1001S	115	E2042S	116
C9528ZH	96	CR6.30.03	124	E1002S	115	E2043S	116
C9529ZH	96	CR6.30.05	124	E1003S	115	E2044S	116
C9530ZH	96	CR6.30.06	124	E1004S	115	E2052S	116
C9531ZH	96	CR6.30.07	124	E1006S	115	E2054S	116
C9532ZH	96	CR6.30.10	124	E1008S	115	E2062S	116
C9533ZH	96	CR6.A3.02	124	E1010S	115	E2064S	116
C9534ZH	96	CR6.A3.03	124	E1012S	115	E2100S	118
C9535ZH	96	CR6.A3.05	124	E1022S	115	E2102S	118
C9536ZH	96	CR6.A3.06	124	E1023S	115	E2103S	118
C9537ZH	96	CR6.A3.07	124	E1024S	115	E2104S	118
C9538A	90	CR6.A3.10	124	E1030S	115	E2106S	118
C9538ZH	96	CT104/SDM	160	E1032S	115	E2108S	118
C9539A	90	CT104/SDMP	160	E1033S	115	E2110S	118
C9539ZH	96	CT504/SDM	160	E1034S	115	E2112S	118
C9540A	90	CT504/SDMP	160	E1036S	115	E2122S	118
C9541A	90	DBRF100	127	E1038S	115	E2123S	118
C9543A	90	DBRF100HF	127	E1040S	115	E2124S	118
C9544A	90	DBRF100R	127	E1041S	115	E2200S	118
C9545A	90	DBRF195	127	E1042S	115	E2202S	118
C9546A	90	DBRF195FL	127	E1043S	115	E2203S	118
C9548A	90	DBRF195HF	127	E1044S	115	E2204S	118
C9549A	90	DBRF195P	128	E1052S	115	E2206S	118
C9550A	90	DBRF200	128	E1054S	115	E2208S	118
C9551A	90	DBRF200FL	128	E1062S	115	E2242S	118
C9552A	90	DBRF200HF	128	E1064S	115	E2243S	118

Catalog Number Index

CATALOG NUMBER	PAGE	CATALOG NUMBER	PAGE	CATALOG NUMBER	PAGE	CATALOG NUMBER	PAGE
E2244S	118	E3606S	105	SSS182R	159	VDM250	158
E2252S	118	E3612S	105	SSS184P	159	VDM250D	158
E2254S	118	E3614S	105	SSS184R	159	VHD1100	158
E2262S	118	E3622S	105	SSS202P	159	VHD1100TK	158
E2264S	118	E3624S	105	SSS202R	159	VPM2000	158
E2402S	99	E3632S	105	SSS204P	159	VPM2000TS	158
E2404S	99	E3634S	105	SSS204R	159	VS32001	158
E2406S	99	E3842S	158	SSS222P	159	VS42001	158
E2482S	101	E3843S	158	SSS222R	159	VS52001	158
E2484S	101	GA61802GFC	159	SSS224P	159	VS62001	158
E2502S	101	GA61804GFC	159	SSS224R	159	VSD2001	158
E2503S	101	GA61806GFC	159	SSS226P	159	VSD2001TS	158
E2504S	101	GA61808GFC	159	SSS226R	159		
E2506S	101	GA61812GFC	159	SSU102P	159		
E2508S	101	GA61816GFC	159	SSU102R	159		
E2522S	101	GA61820GFC	159	SSU122P	159		
E2524S	101	GA61826GFC	159	SSU122R	159		
E2532S	101	GA61832GFC	159	SSU124P	159		
E2534S	101	GA72402GFC	159	SSU124R	159		
E2542S	101	GA72404GFC	159	SSU142P	159		
E2544S	101	GA72408GFC	159	SSU142R	159		
E3000S	117	GA72412GFC	159	SSU144P	159		
E3001S	117	GA72416GFC	159	SSU144R	159		
E3002S	117	GA72426GFC	159	SSU162P	159		
E3003S	117	GA72432GFC	159	SSU162R	159		
E3004S	117	GLC20	159	SSU164P	159		
E3006S	117	GSC102OFC	159	SSU164R	159		
E3008S	117	GSC122OFC	159	SSU182P	159		
E3010S	117	M1042	159	SSU182R	159		
E3012S	117	MM1024	159	SSU184P	159		
E3022S	117	MP1022	159	SSU184R	159		
E3023S	117	MP1201	159	SSU204P	159		
E3024S	117	PA01###EMIF	161	SSU204R	159		
E3030S	117	PA2	161	SSU224P	159		
E3032S	117	PA2C	161	SSU224R	159		
E3033S	117	PA02###EMPF	161	SSU226P	159		
E3034S	117	PA2T	161	SSU226R	159		
E3036S	117	PA8	161	SSUB122	159		
E3038S	117	PA08###EMEF	161	SSUB124	159		
E3042S	117	PA12	161	SSUB142	159		
E3043S	117	PA12C	161	SSUB144	159		
E3044S	117	RGB62	158	SSUB162	159		
E3052S	117	RGB62TS	158	SSUB164	159		
E3054S	117	RGB644	158	SV253SP	158		
E3062S	117	RGB644TS	158	SV253SR	158		
E3064S	117	SSPUB142	159	SV253STR	158		
E3482S	103	SSPUB144	159	SV254SP	158		
E3484S	103	SSPUB162	159	SV254SR	158		
E3502S	103	SSPUB164	159	SV254STR	158		
E3503S	103	SSS122P	159	SV255SP	158		
E3504S	103	SSS122R	159	SV255SR	158		
E3506S	103	SSS124P	159	SV255STR	158		
E3512S	103	SSS124R	159	SV256SR	158		
E3514S	103	SSS142P	159	SV256STR	158		
E3522S	103	SSS142R	159	T02###EMFIFM	161		
E3524S	103	SSS144P	159	VA2/2TP	158		
E3532S	103	SSS144R	159	VA2/3	158		
E3534S	103	SSS162P	159	VA2/3TP	158		
E3542S	105	SSS162R	159	VA2/4	158		
E3602S	105	SSS164P	159	VA2/5	158		
E3603S	105	SSS164R	159	VDM230	158		
E3604S	105	SSS182P	159	VDM230TS	158		

Notes

CAROL
BRAND
EXZEL[™]
EXCEPTIONAL PERFORMANCE

FAILURE IS NOT AN OPTION

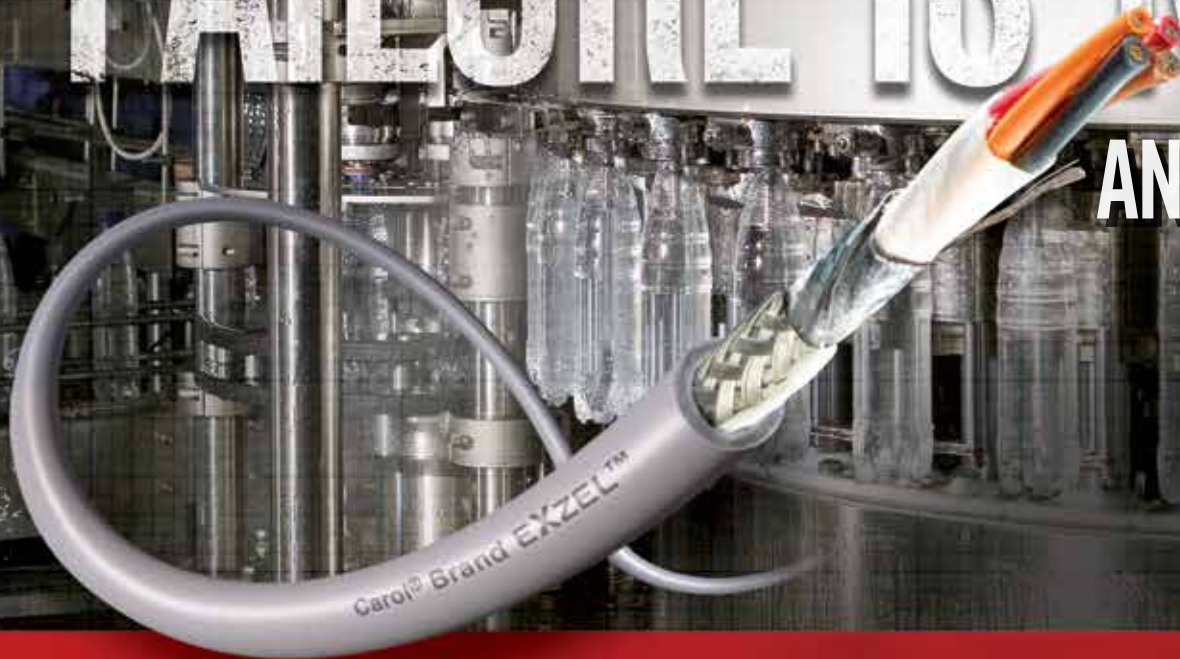

Introducing Carol[®] Brand EXZEL[™] High-Endurance Electronic Cable

Designed for cruel and usual punishment, Carol Brand's EXZEL line is the solution you expect from General Cable, a leading provider of the world's premier wire and cable. Over 165 years of innovation stand behind the "ruggedering" of our high-performing EXZEL line for punishment - it's so tough you can pull, scuff, roll, heat, freeze, bend, throw oil on it* - and it still exze/s. Not always the case with conventional, round gray PVC electronic cables.

Select Carol Brand EXZEL for enduring peace of mind and General Cable for an immediate upgrade beyond just product.

Carol Brand EXZEL, manufactured with quality and dependability, enables critical signals in industries that demand as much, with features like:

- Low-Smoke, Zero-Halogen (LSZH) Constructions
- Various Gauge & Conductor Sizes
- Shielded & Unshielded Constructions
- UV-Resistant
- Jacket Color & Print Legend Customization
- TRU-Mark[®] Sequential Footage Marking
- Low Minimum Order Quantities & Excellent Stocking Position
- Exceptional Customer Service & Technical Expertise

 **General Cable**

www.generalcable.com • 888.295.5896

*Please consult product specifications for additional information.

Global Reach

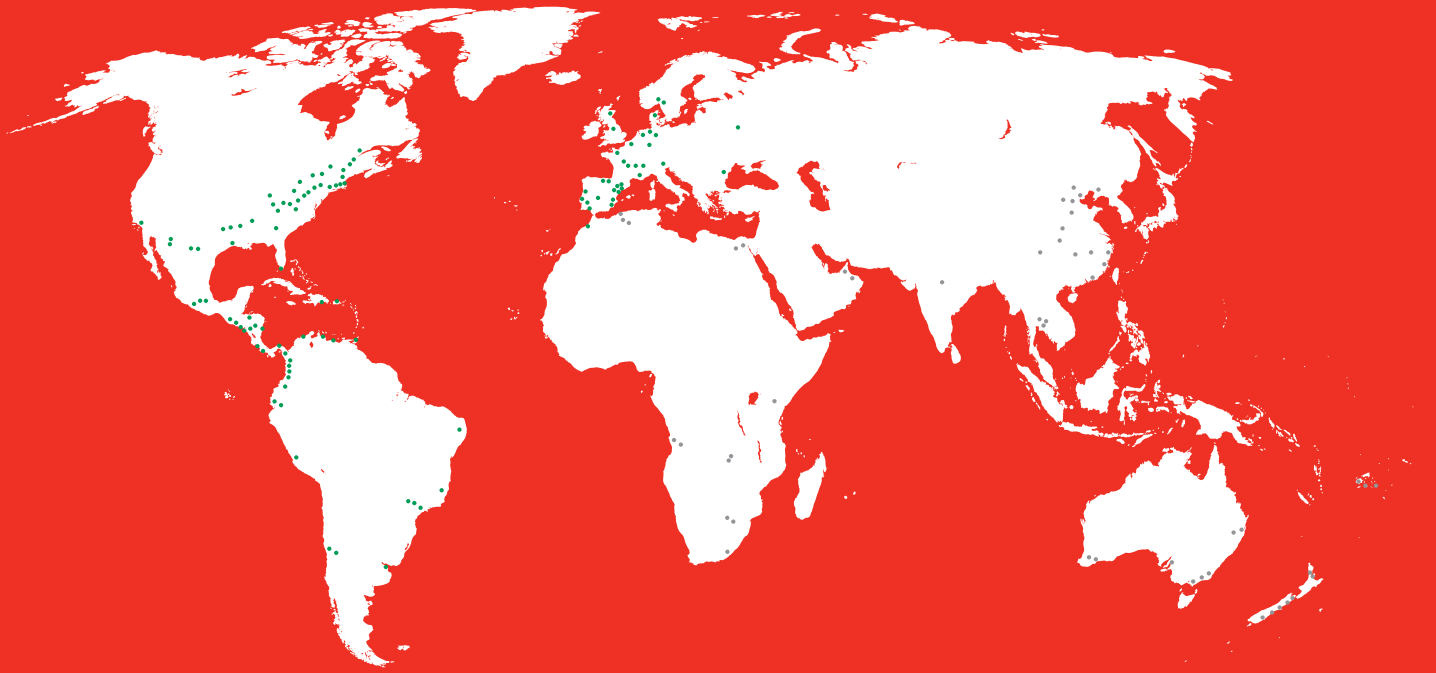

General Cable, a leading wire and cable innovator for over 170 years, serves customers through a global network of manufacturing facilities in our core markets and has worldwide sales representation and distribution. The Company is dedicated to the production of high-quality aluminum, copper and fiber optic wire and cable and systems solutions for the energy, construction, industrial, specialty and communications sectors. In addition to our strong brand recognition and strengths in technology and manufacturing, General Cable is also competitive in such areas as distribution and logistics, marketing, sales and customer service. This combination enables General Cable to better serve its customers as they expand into new geographic markets.

General Cable

4 Tesseneer Drive
Highland Heights, Kentucky 41076-9753
Telephone: 888.295.5896
859.572.8000
Email: info@generalcable.com
www.generalcable.com

156 Parkshore Drive
Brampton, Ontario L6T 5M1
Telephone: 800.561.0649
905.494.5300
Fax: 800.565.2529
Email: infoca@generalcable.com

X-ON Electronics

Largest Supplier of Electrical and Electronic Components

Click to view similar products for Carol manufacturer:

Other Similar products are found below :

[01364.35T.01](#) [01776.38.01](#) [76843.38.06](#) [C0754A.21.10](#) [C1670A.41.10](#) [C2015A.12.04](#) [C2015A.12.19](#) [C2526A.18.10](#) [C3120.18.86](#)
[C4066A.38.10](#) [02727.85.01](#) [01104.99.01](#) [01312.35T.01](#) [01343.35T.01](#) [5133290E](#) [2133016](#) [16065.41.01](#) [5131431E](#) [09814.99.01](#)
[E2206S.41.86](#) [E1524S.41.03](#) [E2534S.41.03](#) [C2016A.12.03](#) [C2064A.12.02](#) [C2103A.12.03](#) [C0570A.41.10](#) [C1302.41.01](#) [C1343A.41.10](#)
[C1357.41.90](#) [C2405A.41.10](#) [C0432A.41.10](#) [C1352A.41.10](#) [C2536A.38.10](#) [C1361.38.90](#) [E2204S.41.02](#) [E3612S.41.03](#) [C5775.27.01](#)
[E2102S.30.86](#) [E1032S.25.10](#) [02604.41T.05](#) [02605.41T.05](#) [02608.41T.05](#) [02634.41T.05](#) [02601.41T.05](#) [C0783A.41.10](#) [E1032S.41.10](#)
[E2024S.41.10](#) [01360.35T.01](#) [01342.35T.01](#) [C0744A.41.10](#)