



三环集团

— SINCE 1970 —

潮州三环（集团）股份有限公司

CHAOZHOU THREE-CIRCLE(GROUP)CO.,LTD

地址：中国广东省潮州市凤塘三环工业城 邮编（Post Code）：515646

ADD:Sanhuan Industrial District,Fengtang Chaozhou,Guangdong,China

## 承认书

### SPECIFICATION FOR APPROVAL

客户名称:	
CUSTOMER:	
产品名称:	多层片式瓷介电容器
PARTNAME:	Multilayer Chip Ceramic Capacitor
产品规格:	TCC0402COG681J500AT
SPECIFICATION:	TCC0402COG681J500AT
承认书编号:	DRAAW108M/1-2023
APPROVAL SHEET NO.:	DRAAW108M/1-2023
发出日期	2024/1/22
ISSUED DATE:	2024/1/22

制造		
MANUFACTURER		
批准	审核	经办
APPROVED	CHECKED	PREPARED
孙鹏	王彬彬	陈家锐

客户		
CUSTOMER		
批准	审核	经办
APPROVED	CHECKED	PREPARED

### 潮州三环（集团）股份有限公司

地址 1: 中国广东省潮州市凤塘三环工业城(潮州总部)

地址 2: 四川省南充市高坪区清溪街道南充三环集团三厂区(南充基地)

地址 3: 深圳光明区凤凰街道甲子塘社区三环科技大厦(深圳基地)

总部电话: 86-768-6855932

总部传真: 86-768-6855921

网址: HTTP://WWW.CCTC.CC

电话(Tel): 86-768-6855949, 658923

E-mail:gyc@cctc.cc

传真(Fax): (768)6855928, 6855921

Website:Http://www.cctc.cc

文件编号	DRAAW108M/1-2023		页数	23
文件名称	多层片式陶瓷电容器(产品承认书)		制订日期	2012. 01
版数	制定、修订日期	页数	制定、修订内容	登记者
B/0	2012/1/11	38	新制定	方千军
B/1	2012/8/11	36	增加2225、1808尺寸的载带尺寸	王彬彬
C/0	2013/1/10	39	换版	王彬彬
D/0	2014/1/6	39	更新SGS报告	王彬彬
E/0	2014/5/6	29	换版	张国信
F/0	2015/2/10	28	换版	张国信
G/0	2016/5/15	23	换版	张国信
H/0	2017/7/1	23	换版	张国信
I/0	2020/2/15	23	换版	张国信
J/0	2021/1/7	23	换版	张国信
K/0	2022/3/18	23	换版	张国信
K/1	2022/11/28	23	增加RoHS、REACH和无卤要求	陈家锐
L/0	2023/1/16	23	换版	陈家锐
L/1	2023/2/1	23	更新容值	陈家锐
L/2	2023/2/24	23	更新0105容值	陈家锐
L/3	2023/5/13	23	更新容值，增加波峰焊/回流焊的规格范围，增加引入标准备注	陈家锐
M/0	2023/9/15	23	更新容值、深圳基地地址和中盒包装尺寸	陈家锐
M/1	2023/12/8	24	更新容值、纸带尺寸	张国信

电话(Tel): 86-768-6855949, 658923

E-mail:gyc@cctc.cc

传真(Fax): (768)6855928, 6855921

Website:Http://www.cctc.cc

## 目录

1. 电容器及介质分类.....	4
2. 产品结构.....	4
3. 产品规格型号命名规则.....	5
4. 产品尺寸.....	5
5. 技术要求和测试条件.....	6
6. 产品包装.....	15
7. MLCC使用注意事项.....	18

## 1. 电容器及介质分类 Types of Capacitor and Dielectric Material

※COG：此类介质材料的电容器为 I 类电容器，包括常规、中高压COG产品。此类产品电性能稳定，几乎不随温度、电压和时间的变化而变化。适用于低损耗，稳定性要求高的电路中，如滤波器、谐振器和计时电路中。

※COG：The capacitor of this kind dielectric material is considered as Class I capacitor, including general capacitor and high frequency COG capacitor. The electrical properties of COG capacitor are the most stable one and have little change with temperature, voltage and time. They are suited for applications where low-losses and high-stability are required, such as filters, oscillators, and timing circuits.

## 2. 产品结构 Product Frame



序号	名称
1	陶瓷介质
2	内电极
3	外电极
4	镍层
5	锡层

电话(Tel): 86-768-6855949, 658923

E-mail:gyc@cctc.cc

传真(Fax): (768) 6855928, 6855921

Website:Http://www.cctc.cc

### 3. 产品规格型号命名规则

#### General Product Parts Numbering System

(例) (example)

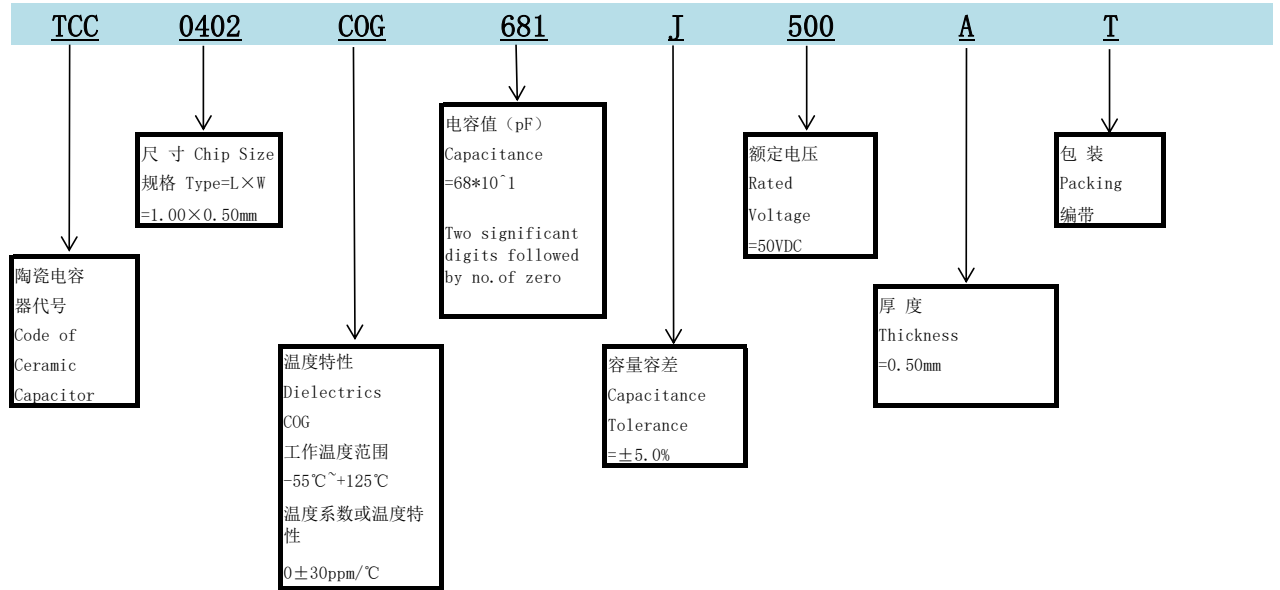

### 4. 产品尺寸 Dimensions

规格: 0402  
Chip Size: 0402

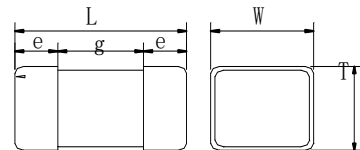

规格	L	W	e	g min	T
Type	(mm)	(mm)	(mm)	(mm)	(mm)
0402	1.00±0.10	0.50±0.10	0.15~0.3	0.40	0.50±0.10

电话(Tel): 86-768-6855949, 658923

E-mail: gyc@cctc.cc

传真(Fax): (768) 6855928, 6855921

Website: Http://www.cctc.cc

## 5. 技术要求和测试条件 Specification and Test Condition

### 5.1 外观 Appearance

类型 Dielectrics	技术要求 Specification	测试条件 Testing
COG	$l \leq 1/8L, w \leq 1/8W, t \leq 1/8T$	目视检查 Visual inspection.

### 5.2 尺寸 Dimensions

类型 Dielectrics	技术要求 Specification	测试条件 Testing Condition
COG	在要求的范围内 Within the specified dimensions	用千分尺 Using calipers on micrometer

### 5.3 容量 Capacitance

类型 Dielectrics	技术要求 Specification	测试条件 Testing Condition
COG	在要求的容值容差范围内 Within the specified tolerance 646~714pF	$1.0 \pm 0.2V_{rms}, 1MHz \pm 10\%$ ;
备注：测试温度：25℃±3℃，测试湿度：<70%RH. 针对二类介质规格需去老化处理，条件：电容器在150℃热处理1小时，放置48小时后进行测量。		

### 5.4 损耗 Dissipation Factor

类型 Dielectrics	技术要求 Specification	测试条件 Testing Condition
COG	$DF \leq 0.1\%$	$1.0 \pm 0.2V_{rms}, 1MHz \pm 10\%$ ;
备注：测试温度：25℃±3℃，测试湿度：<70%RH. 针对二类介质规格需去老化处理，条件：电容器在150℃热处理1小时，放置48小时后进行测量。		

### 5.5 绝缘电阻 Insulation Resistance

类型 Dielectrics	技术要求 Specification	测试条件 Testing Condition
COG	$\geq 10G \Omega$	测试电压: 50V; 充电时间: 60±5秒; 温度: 25℃; test voltage: 50V; Charge Time: 60±5sec; Temperature: 25℃
备注: 测试温度: 25℃±3℃, 测试湿度: <70%RH.		

### 5.6 耐电压 Dielectric Strength

类型 Dielectrics	额定电压范围 Rated voltage range	耐电压性能测试方法 Measuring Method
COG	UR=50V	施加电压150VDC, 5秒, 最大电流不超过50mA; Force 150VDC for 5second. Max. current should not exceed 50 mA.
备注: 测试温度: 25℃±3℃, 测试湿度: <70%RH.		

### 5.7 静电容量温度特性 Temperature Coefficient of Capacitance

类型 Dielectrics	技术要求 Specification	测试条件 Testing Condition	
COG	容量变化在±30ppm/℃以内, 容量漂移在±0.2%以内; Temperature coefficient within ±30ppm/℃; Cp drift within ±0.2%	按系列温度顺序测试电容量	
		Measure capacitance under follow table list temperature(℃):	
		在140~150℃预处理1小时, 放置24小时后进行测量, 测试电压≤1Vrms。	
		步骤 STEP	COG
		1	25±2
		2	-55±3
		3	25±2
4	125±3		
5	25±2		
		COG 容量漂移的计算方法为: 用步骤3测量的电容量除以在第1、3和5步骤测量得到的误差的最大值和最小值的差。温度系数的计算以第3步骤测量电容量为参考。The capacitance drift is calculated by dividing the differences between the maximum and minimum measured values in the step 1,3 and 5. The temperature coefficient is determined using the Capacitance measured in step 3 as a reference.	

5.8 附着力 Adhesion

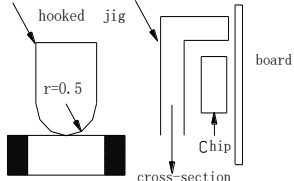
类型 Dielectrics	技术要求 Specification	测试条件 Testing Condition
COG	端电极无松动，也无其它不良现象 No removal of the terminations or other defect shall occur.	施加6N的压力，并保持10±1秒 The pressurizing force shall be 6N and the duration of application shall be 10±1sec. 

5.9 可焊性 Solderability of Termination

类型 Dielectrics	技术要求 Specification	测试条件 Testing Condition
COG	端电极挂锡面积不小于95%，针孔或粗糙面积小于5%。 95% min-coverage of both terminal electrodes and less than 5% have pin holes or rough spots.	锡炉温度：245±5℃ 浸入时间：2±1秒 两侧端电极完全浸入焊锡炉 Solder temperature: 245±5℃ Dipping time: 2±1 seconds. Completely soak both terminal electrodes in solder.

5.10 耐焊性 Resistance to leaching

类型 Dielectrics	技术要求 Specification	测试条件 Testing Condition
COG	端电极挂锡面积不小于95%，针孔或粗糙面积小于5%，外观无开裂。 95% min. coverage of both terminal electrodes and less than 5% have pin holes or rough spots.No remarkable visual damage.	预热：120℃~150℃/60秒 锡炉温度：270±5℃ 浸入时间：10±1秒 两侧端电极完全浸入焊锡炉 Solder temperature: 270±5℃ preheated: 120℃~150℃/60sec Dipping time: 10±1 seconds. Completely soak both terminal electrodes in solder.

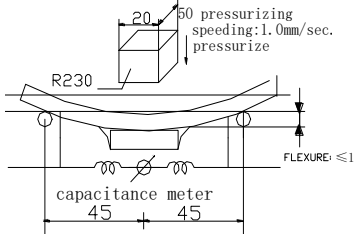

5.11 端电极结合强度 Bending

类型 Dielectrics	技术要求 Specification	测试条件 Testing Condition
COG	无可见损伤；容量变化小于等于±5% No remarkable visual damage; Cp change ≤ ± 5%.	<p>将片状电容器安装在测试夹具上，按图所示方向以1.0mm/s的速率施加压力，弯曲1mm。</p> <p>Solder the capacitor on testing substrate and put it on testing stand. The middle part of substrate shall successively be pressurized by pressuring rod at a rate of about 1.0mm/sec. Until the deflection become means of the 1mm.</p> 



5.12 耐焊接热 Resistance to Soldering Heat

类型 Dielectrics	技术要求 Specification	测试条件 Testing Condition
COG	<p>无明显可见损伤,容量变化在±2.5%以内,DF满足产品初始值的要求,IR满足产品初始值的要求</p> <p>No remarkable visual damage,Cp change within ±2.5%, whichever is larger.DF meets initial standard value. IR meets initial standard value.</p>	<p>焊接温度: 270±5℃            预热: 120~150℃ 60秒            浸入时间: 10±1秒            在室温下放置24±2 小时以后测量            试验后在标准条件下恢复</p> <p>*高介电常数电容器的初始值测量            在140~150℃进行1小时的热处理后在室温下放置48±4小时            测量初始值</p> <p>Soldering temperature: 270±5℃            Preheating: 120~150℃ 60sec.            Dipping time: 10±1 seconds.</p> <p>Measurement to be made after being kept at room temperature for 24±2hours.Recovery for the following period under the standard condition after test.</p> <p>*Initial measurement for high dielectric constant typePerform a heat treatment at 140~150℃ for 1hr and let sit for 48±4hrs at room temperature.Perform the initial measurement.</p>

电话(Tel): 86-768-6855949, 658923

E-mail:gyc@cctc.cc

传真(Fax): (768)6855928, 6855921

Website:Http://www.cctc.cc

5.13 温度快速循环 Temperature Cycle

类型 Dielectrics	技术要求 Specification	测试条件 Testing Condition															
COG	<p>无明显可见损伤，容量变化在±2.5%以内。 No remarkable visual damage. Cp change within ±2.5%.</p>	<p>按下列步骤进行5次循环： To perform 5 cycles of the stated environment</p> <table border="0"> <tr> <td>步骤Step</td> <td>温度</td> <td>时间</td> </tr> <tr> <td>1</td> <td>下限类别温度+0/-3℃ Min. operating Temp. +0/-3℃</td> <td>30min</td> </tr> <tr> <td>2</td> <td>25℃</td> <td>2~3 min</td> </tr> <tr> <td>3</td> <td>上限类别温度+3/-0℃ Max. operating Temp. +3/-0℃</td> <td>30 min</td> </tr> <tr> <td>4</td> <td>25℃</td> <td>2~3 min</td> </tr> </table> <p>在室温下放置24±2小时以后测量。</p> <p>*高介电常数电容器的初始值测量。 在140~150℃进行1小时的热处理后在室温下放置48±4小时测量初始值。</p> <p>Measurement to be made after being kept at room temperature for 24±2hrs at room temperature, then measure.</p> <p>*Initial measurement for high dielectric constant type. Perform a heat treatment at 140~150℃ for 1hr and let sit for 48±4hrs at room temperature. Perform the initial measurement.</p>	步骤Step	温度	时间	1	下限类别温度+0/-3℃ Min. operating Temp. +0/-3℃	30min	2	25℃	2~3 min	3	上限类别温度+3/-0℃ Max. operating Temp. +3/-0℃	30 min	4	25℃	2~3 min
步骤Step	温度	时间															
1	下限类别温度+0/-3℃ Min. operating Temp. +0/-3℃	30min															
2	25℃	2~3 min															
3	上限类别温度+3/-0℃ Max. operating Temp. +3/-0℃	30 min															
4	25℃	2~3 min															

5.14 稳态湿热 Moisture Resistance , steady state

类型 Dielectrics	技术要求 Specification	测试条件 Testing Condition
COG	外观无明显可见损伤，容量变化在±5%以内 $DF \leq 0.29\%$ $IR: \geq 1000M\Omega$ No remarkable visual damage, Cp change within ±5%. $DF \leq 0.29\%$ $IR \geq 1000M\Omega$	测试温度：40±2℃ 湿度：90~95% RH 测试时间：500 ±12hrs 在室温下放置24±2小时以后测量  *高介电常数电容器的初始值测量在140~150℃进行1小时的热处理后在室温下放置48±4小时测量初始值。  Test temperature: 40±2℃ Humidity: 90~95% RH Testing time: 500 ±12hrs Measurement to be made after being kept at room temperature for 24±2hrs.  *Initial measurement for high dielectric constant type. Perform a heat treatment at 140~150℃ for 1hr and let sit for 48±4hrs at room temperature. Perform the initial measurement.

5.15 耐湿负荷 Damp heat with load

类型 Dielectrics	技术要求 Specification	测试条件 Testing Condition
COG	外观无明显可见损伤,容量变化在±5%以内; DF≤0.50% IR: 大于等于500MΩ  No remarkable visual damage, Cp change≤±7.5% DF≤0.50% IR≥500MΩ	测试温度: 40±2℃ 湿度: 90~95% RH 电压: 额定电压 测试时间: 500 ±12hrs 充放电电流: ≤50mA 初始测量需在焊接后, 在室温下放置24±2小时以后测量。 *高介电常数电容器的测量 在实验结束后, 需在150℃温度下, 保持1h后, 再放置48h后再测试电性能  Test temperature: 40±2℃ Humidity: 90~95% RH Voltage: 100% of the rated Charge/discharge current 50mA max Testing time: 500 ±12hrs After soldering,, Measurement to be made after being kept at room temperature for 24±2hrs *Measurement for high dielectric constant type. After experiment, product need to keep in 150℃、1h, and measurement to be made after being kept at room temperature for 48h.
备注：该项可靠性试验仅适用于常规产品，不适用于中高压产品。		



5.16 耐久性 Life Test

类型 Dielectrics	技术要求 Specification	测试条件 Testing Condition
COG	<p>外观无明显可见损伤, 容量变化在±3.0%以内 DF≤0.29% IR: 大于等于1000MΩ</p> <p>No remarkable visual damage Cp change≤±3.0% DF≤0.29% IR≥1000MΩ</p>	<p>测试温度：上限类别温度±3℃ 1.5倍额定电压</p> <p>充放电电流：≤50mA 测试时间：1000 小时 初始测量需在焊接后，在室温下放置24±2小时以后测量。 *高介电常数电容器的测量</p> <p>在实验结束后，需在150℃温度下，保持1h后，再放置48h后再测试电性能</p> <p>Test temperature: Max. Operating Temp. ±3℃ Voltage: 150% of the rated voltage</p> <p>Charge/discharge current 50mA max Testing time: 1000 hrs After soldering, Measurement to be made after being kept at room temperature for 24±2hrs. *Measurement for high dielectric constant type.</p> <p>After experiment, product need to keep in 150℃、1h, and Measurement to be made after being kept at room temperature</p>

## 6. 产品包装 Packing

### 6.1 袋式散装 Bulk Packing

10000个/袋或按客户要求。Standard packing 10Kpcs/bag; others are according to customer request.

### 6.2 编带式包装 Tape Packing

规格 Type	尺寸 Size (mm)			编带数量(个/盘 pcs/reel)	
	长度L	宽度W	厚度T	纸带Paper Tape	塑料带Plastic Tape
0402	1.00	0.50	0.50	10000	N/A
	-	-	-	-	-

#### 6.2.1 纸带尺寸 Dimensions of Packing Paper

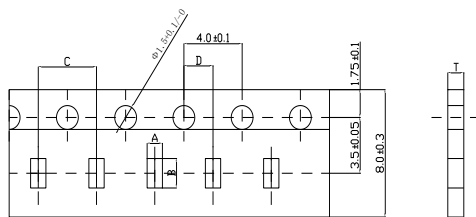

Type	A	B	C	D	T
0105	0.23±0.03	0.43±0.03	1.00±0.10	1.00±0.05	0.3max
0201	0.40±0.09	0.70±0.09	2.0±0.10	2.0±0.05	0.42max
0402	0.65±0.15	1.20±0.15	2.0±0.05	2.0±0.05	0.8max
0603	1.05±0.15	1.90±0.15	4.0±0.10	2.0±0.10	1.1max
0805	1.55±0.15	2.3±0.15	4.0±0.10	2.0±0.10	1.1max
1206	2.00±0.04	3.5±0.04	4.0±0.10	2.0±0.10	1.1max

(单位unit:毫米mm)

#### 6.2.2 塑料带尺寸 Dimensions of Embossed Packing

8mm宽, 4mm间距编带

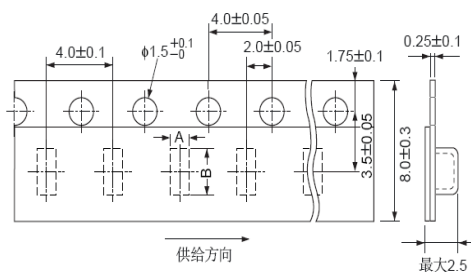

12mm宽, 8mm/4mm间距编带

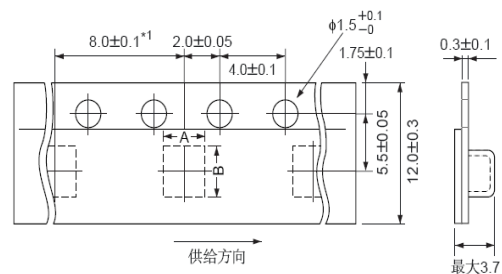

A: 1.40±0.20 B: 2.25±0.20 (0805) A: 1.90±0.20 B: 3.50±0.20 (1206)  
A: 2.90±0.30 B: 3.60±0.30 (1210) A: 3.60±0.20 B: 5.00±0.20 (1812)

(单位unit:毫米mm)

电话(Tel): 86-768-6855949, 658923

E-mail:gyc@cctc.cc

传真(Fax): (768) 6855928, 6855921

Website:Http://www.cctc.cc

### 6.2.3 编带盘尺寸 Dimensions of Reel

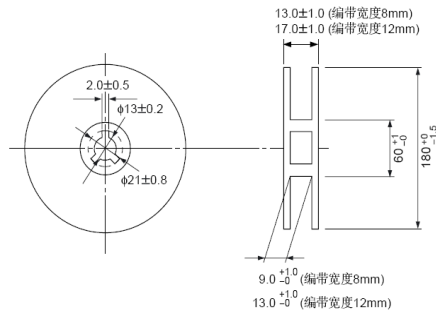

### 6.2.4 编带方式 Taping Figure

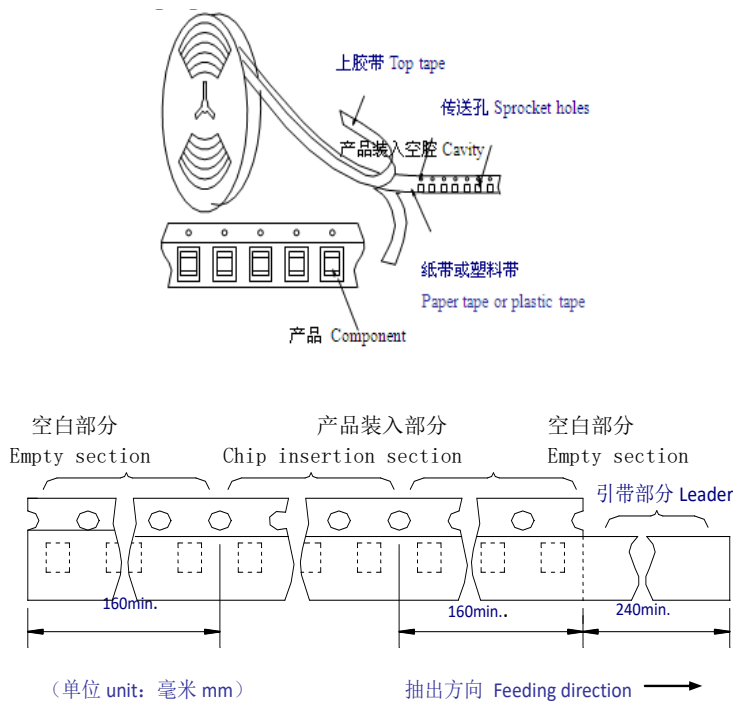

### 6.2.5 编带方法 Taping Method

- ① 包装电容器的编带是顺时针卷绕的，由上往下的方向拉出编带时，传送孔处于编带的右侧。
- ② 在编带的前端，至少留出5个间距的引出带。
- ③ 在编带时，必须按下图留出引带部分或空白部分。
- ④ 在盘带的安装中的产品装错的数量每盘必须小于表示数量的0.1%或1个为限，不连续发生错误。
- ⑤ 上胶带和下胶带不应超出编带的边缘，不能挡住传送孔。
- ⑥ 传送孔的累计误差为10个间距：±0.3毫米以内。
- ⑦ 上胶带的剥离力矩应在0.1至0.6牛顿以内，其方向如下图所示。



- ① Tapes for capacitors are wound clockwise. The sprocket holes are to the right as the tape is pulled toward the user.
- ② The top tape and base tape are not attached at the end of the tape for a minimum of 5 pitches.
- ③ Part of the leader and part of the empty tape shall be attached to the end of the tape as follows.
- ④ Missing capacitors number within 0.1% of the number per reel or lpc, whichever is greater, and are not continuous.
- ⑤ The top tape and bottom tape shall not protrude beyond the edges of the tape and shall not cover sprocket holes.
- ⑥ Cumulative tolerance of sprocket holes, 10 pitches:  $\pm 0.3\text{mm}$ .
- ⑦ Peeling off force: 0.1 to 0.6N in the direction shown down.

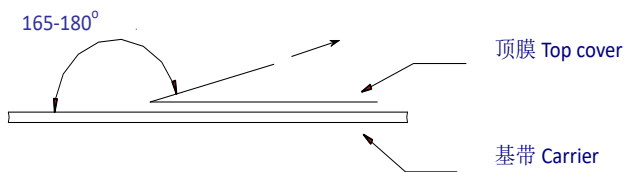

#### 6.2.6 产品标签 Reel Label

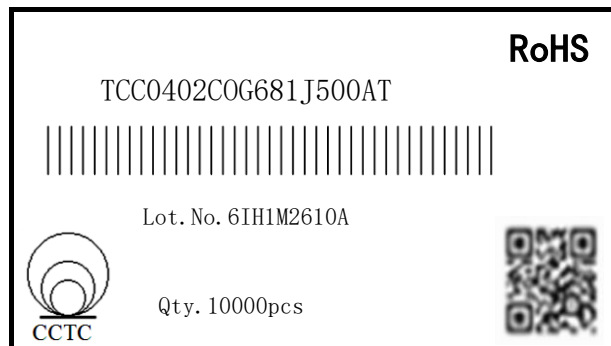

标签内容 The Contents of Label

(1)

<u>TCC</u>	<u>0402</u>	<u>COG</u>	<u>681</u>	<u>J</u>	<u>500</u>	<u>A</u>	<u>I</u>
①	②	③	④	⑤	⑥	⑦	⑧

①陶瓷电容器代号Code of Ceramic Capacitor

②尺寸chip size, ③温度特性dielectrics, ④容量capacitance, ⑤容量容差tolerance,

⑥额定电压rated voltage, ⑦厚度thickness, ⑧包装packing

(2) 产品批号Lot. No.: 6IH1M2610A

(3) 数量Qty: 10000pcs

(4) RoHS: GREEN PARTS 绿色物料

电话(Tel): 86-768-6855949, 658923

传真(Fax): (768)6855928, 6855921

E-mail: gyc@cctc.cc

Website: Http://www.cctc.cc



再流焊接时推荐设计的尺寸（单位：mm）

Recommended land dimensions for reflow-soldering (unit: mm)

规格SIZE		0402
尺寸 (mm)	L	1
	W	0.5
A		0.35~0.45
B		0.40~0.50
C		0.45~0.55

过量的焊锡会影响产品抵抗机械应力的能力，因此在设计图案时应引起注意。

Excess solder can affect the ability of chips to withstand mechanical stresses.

Therefore, please take proper precautions when designing land-patterns.

在应用中一些焊接好与坏的情况：

Examples of good and bad solder application.

项目Item	不推荐结构Not recommended	推荐结构Recommended
片状元件和带引线的元件的混合焊接 Mixed mounting of SMD and leaded component		
靠近底座的焊接 Component placement close to the chassis		
在片状元件附近带引线元件的焊接 Hand-soldering of leaded components near mounted		

### 7.1.2 图案结构 Pattern configurations

下面是电容器安装好与坏的例子。选择贴装位置，应尽可能减小电路板在弯曲时受到的机械应力。

The following are examples of good and bad capacitor layout, SMD capacitors should be located to minimize any possible mechanical stresses from board warp or deflection.

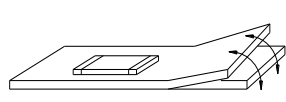
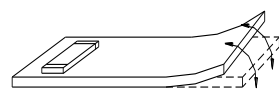
项目Item	不推荐结构Not recommended	推荐结构Recommended
电路板弯曲 Deflection of the board		

对于电路板分拨的电容器，在分拨时受到的机械应力大小与电容器的安装有关。

下面推荐了一些好的设计。

To layout the capacitors for the breakaway PC board, it should be noted that the amount of mechanical stresses given depending on capacitor layout. The example below shows recommendations for better design.

电话(Tel): 86-768-6855949, 658923

传真(Fax): (768) 6855928, 6855921

E-mail: gyc@cctc.cc

Website: Http://www.cctc.cc



在沿着分拨线分拨电路板时，对产品施加的机械应力与使用的方法关系很大。分折电路板时片状元件受到的疲劳按照如下顺序增大：分折、剪切、V型槽、穿孔。因此，贴装时应该考虑电路板的分拨过程。

When breaking PC boards along their perforations, the amount of mechanical stress on the capacitors can vary according to the method used. The following methods are listed in order from least stressful to most stressful: push-back, silt, -grooving, and perforation. Thus, any ideal SMD capacitor layout must also consider the PCB splitting procedure.

## 7.2 自动贴装注意事项 Considerations for automatic placement

贴装机的调整 Adjustment of mounting machine

- ①. 产品在电路板贴装时，不应该受到过大的冲击。
- ②. 必须定期对吸头和定位爪进行检查、维修和更换。
- ①. Excessive impact load should not be imposed on the capacitors when mounting the PC boards.
- ②. The maintenance and inspection of the mounters should be conducted periodically.

项目Item	不推荐结构Not recommended	推荐结构Recommended
单面贴装 Single-sided mounting		
双面贴装 Double-sided mounting		

## 7.3 推荐焊接曲线 Recommended soldering profile

7.3.1 说明：

- ① 产品推荐使用回流焊接工艺；
- ② 大尺寸产品适用于回流焊接工艺。

Re:

- ①flow Soldering is recommended;
- ②flow soldering is suitable for bigger size MLCCs.

电话(Tel): 86-768-6855949, 658923

E-mail: gyc@cctc.cc

传真(Fax): (768) 6855928, 6855921

Website: Http://www.cctc.cc

7.3.2 锡铅焊接曲线 Recommended Sn&Pb soldering profile

**再流焊 Reflow soldering**

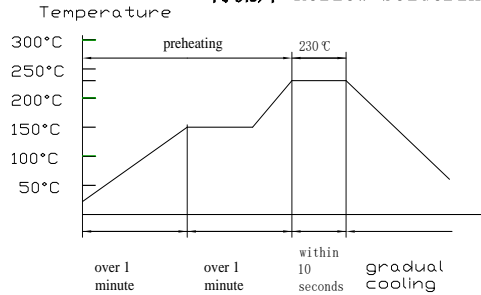

**注意 Caution**

①理想状况的焊锡高度为电容器厚度的1/3 ~1/2，如下图所示：

①The ideal condition is to have solder mass (fillet) controlled to 1/2 to 1/3of the thickness of the capacitor, as shown below:

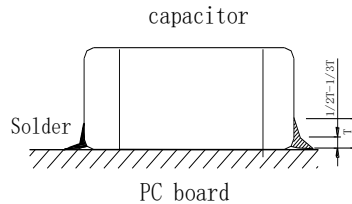

②过长的焊接时间会影响端头的可焊性，焊接时间尽可能保持与推荐时间一致。

②Because excessive dwell times can detrimentally affect solderability, soldering duration should be kept as close to recommended times as possible.

**波峰焊 Wave solder profile**

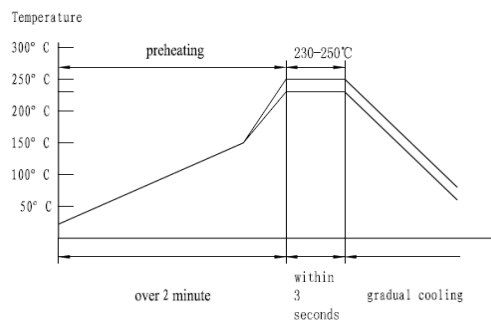

**注意Caution**

①. 确保电容器充分预热。

②. 产品预热和焊接温度差不超过100~130°C。

③. 焊接后尽可能慢速冷却。

①.Make sure the capacitors are preheated sufficiently.

②.The temperature difference between the capacitor and melted solder should not be greater than 100 to 130°C.

③.Cooling after soldering should be gradual as possible.

电话 (Tel): 86-768-6855949, 658923

传真 (Fax): (768) 6855928, 6855921

E-mail: gyc@cctc.cc

Website: Http://www.cctc.cc

手工焊接 Hand soldering

条件:

预热	烙铁头温度	烙铁功率	烙铁头直径	焊接时间	锡膏量	限制条件
$\Delta \leq 130^{\circ}\text{C}$	最高 $350^{\circ}\text{C}$	最大20W	建议1mm	最长5s	$\leq 1/2$ 芯片厚度	请勿使用烙铁头直接接触陶瓷原件

注意 Caution

①. 用尖端最大直径1.0mm功率20W的焊接烙铁。

②. 焊接烙铁不要直接接触产品。

①. Use a 20w soldering iron with a maximum tip diameter of 1.0mm.

②. The soldering iron should not directly touch the capacitor.

7.3.3无铅焊接曲线 Recommended Pb-Free soldering profile

回流焊接 Reflow solder

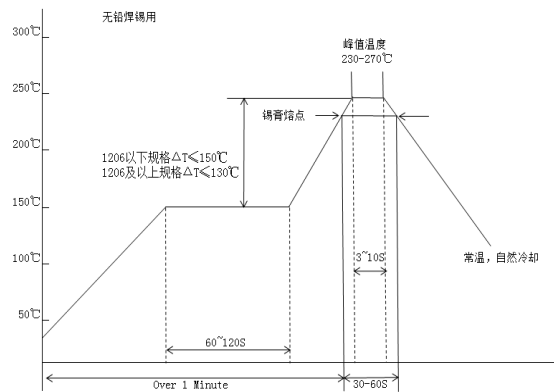

波峰焊接 Wave solder profile



波峰焊/回流焊的容值范围 Capacitance range of Wave solder profile and Reflow solder:

焊接模式 Welding mode	0402	0603	0805	1206	1210
波峰焊 Wave solder profile	/	105 及以下容值 Capacitance of 105 and below	225 及以下容值 Capacitance of 225 and below	475 及以下容值 Capacitance of 475 and below	/
回流焊 Reflow solder	所有规格 All Specifications	105 以上容值 Capacitance above 105	225 以上容值 Capacitance above 225	475 以上容值 Capacitance above 475	所有规格 All Specifications

电话(Tel): 86-768-6855949, 658923

传真(Fax): (768) 6855928, 6855921

E-mail: gyc@cctc.cc

Website: Http://www.cctc.cc

#### 7.4 分拨电路板 Handling

Breakaway PC boards (splitting along perforations)

- (1). 在电容器或其它贴装后，必须注意因电路板弯曲或变形带来的应力。
- (2). 分拨电路板时必须使用专用的夹具，不可以用手拨断。
- (1).When splitting the PC board after mounting capacitors and other components, care is required so as not to give any stresses of deflection or twisting to the board.
- (2).Board separation should not be done manually, but by using the appropriate devices.

#### 7.5保存 Storage

- (1). 在下列环境中保存产品：温度 5~40℃；湿度 ≤70% RH
- (2). 产品自生产之日保存期为一年，产品使用之前请勿拆开编带。
- (3). 编带拆开后，产品应在三个月内使用。
- (4). 高介电常数电容器（X7R, X5R, Y5V, X6S, X7T, X6T, X7S）的容值随时间会逐渐减小，所以在电路设计时应充分考虑这一现象。容值减小的电容器在150℃热处理1小时后容值会恢复到初试值。
- (1). Keep the storage environment conditions as following: Temperature: 5~40℃; Humidity: ≤70% RH
- (2). Don't open the tape until the parts are to be used, and store them within one year since the date printed on the reel.
- (3). Use the chips within 3 months after the tape is opened.
- (4). The capacitance value of high dielectric constant capacitors (X7R, X5R, Y5V, X6S, X7T, X6T, X7S) will gradually decrease with the passage of time, so this should be taken into consideration in the circuit design. If such a capacitance reduction occurs, a heat treatment of 150℃ for 1 hour will return the capacitance to its initial level.

#### 7.6 环保申明 Environmental Declaration

- (1). 我司所有MLCC产品均符合RoHS 2.0标准；
- (2). 我司所有MLCC产品均符合最新的REACH法规要求；
- (3). 我司所有MLCC产品均符合HF要求。
- (1).All MLCC products of our comply with RoHS 2.0;
- (2).All MLCC products of our comply with the latest REACH regulations;
- (3).All MLCC products of our comply meet HF requirements.

## X-ON Electronics

Largest Supplier of Electrical and Electronic Components

*Click to view similar products for [Multilayer Ceramic Capacitors MLCC - SMD/SMT](#) category:*

*Click to view products by [CCTC](#) manufacturer:*

Other Similar products are found below :

[M39014/02-1218V](#) [M39014/02-1225V](#) [M39014/22-0631](#) [D55342E07B523DR-T/R](#) [NCA1206X7R103K50TRPF](#) [NCA1206X7R104K16TRPF](#)  
[NIN-FC2R7JTRF](#) [NMC0402NPO220J50TRPF](#) [NMC0402X5R105K6.3TRPF](#) [NMC0402X5R224K6.3TRPF](#) [NMC0402X7R103J25TRPF](#)  
[NMC0402X7R392K50TRPF](#) [NMC0603NPO201J50TRPF](#) [NMC0603X7R333K16TRPF](#) [NMC0805NPO820J50TRPF](#)  
[NMC0805X7R224K16TRPLPF](#) [NMC1206X7R102K50TRPF](#) [NMC1206X7R106K10TRPLPF](#) [NMC1206X7R475K10TRPLPF](#)  
[C1608C0G2A221J](#) [C1608X7R1E334K](#) [C2012C0G2A472J](#) [2220J2K00562KXT](#) [CDR33BX104AKUR](#) [CDR33BX683AKUS](#)  
[CGA3E1X7R1C684K](#) [CL10C0R8BB8ANNC](#) [C1005X5R0G225M](#) [C2012X7R2E223K](#) [C3216C0G2J272J](#) [D55342E07B35E7R-T/R](#)  
[NMC0402X7R562J25TRPF](#) [NMC0603NPO102J25TRPF](#) [NMC1206X7R332K50TRPF](#) [726632-1](#) [CGA6M3X7R1H225K](#)  
[CGA5L2X7R2A105K](#) [CGA3E2X8R1H223K](#) [CDR33BX823AKUR\M500](#) [CDR35BX474AKUR\M500](#) [CDR35BX104BKUR\M500](#) [69995D](#)  
[NMC0201X5R473K6.3TRPF](#) [NMC0201X7R221K25TRPF](#) [NMC0402X5R105K10TRPF](#) [NMC0402X5R224K10TRPF](#)  
[NMC0603X7R104J25TRPF](#) [NMC0603X7R223K25TRPF](#) [NMC0805NPO100J50TRPF](#) [NMC0805X7R104M50TRPF](#)