



CCTC
三环集团

潮州三环（集团）股份有限公司
Chaozhou Three-Circle (Group) Co., Ltd.

地址：广东省潮州市凤塘三环工业城

邮编(Post Code)：515646

ADD：San Huan Industrial District ,Feng Tang Chao Zhou, GuangDong, China

承 认 书

SPECIFICATION FOR APPROVAL

客户名称：

CUSTOMER: _____

产品名称

多层片式瓷介电容器

PARTNAME: _____

Multilayer Chip Ceramic Capacitor

产品规格

通用系列

SPECIFICATION: _____

承认书编号

APPROVAL SHEET NO.:

DRAAW108HK/1-2022

发出日期

ISSUED DATE: _____

| 制造 MANUFACTURER | | | 客户 CUSTOMER | | |
|--------------------|---------------|----------------|----------------|---------------|----------------|
| 批准 APPROVED | 审核 CHECKED | 经办 PREPARED | 批准 APPROVED | 审核 CHECKED | 经办 PREPARED |
| 梁俊 | 王彬彬 | 张国信 | | | |

潮州三环（集团）股份有限公司

地址 1：中国广东省潮州市凤塘三环工业城(潮州总部)

地址 2：四川省南充市高坪区清溪街道南充三环集团三厂区（南充基地）

地址 3：广东省深圳市光明区光源五路汇业科技园（深圳基地）

总部电话：86-768-6855932

总部传真：86-768-6855921

网址：HTTP：//WWW.CCTC.CC



CCTC
三环集团

潮州三环（集团）股份有限公司
Chaozhou Three-Circle (Group) Co., Ltd.

地址：广东省潮州市凤塘三环工业城

邮编(Post Code)：515646

ADD：San Huan Industrial District ,Feng Tang Chao Zhou, GuangDong, China

| 文件编号 | DRAAW108K/1-2022 | | | 页数 | 39 |
|------|------------------|----|---|------|---------|
| 文件名称 | 多层片式陶瓷电容器(产品承认书) | | | 制订日期 | 2012.01 |
| 版数 | 制定、修订日期 | 页数 | 制定、修订内容 | 登记者 | |
| B/0 | 2012-01-11 | 38 | 新制定 | 方千军 | |
| B/1 | 2012-08-11 | 36 | 增加 2225、1808 尺寸的载带尺寸 | 王彬彬 | |
| C/0 | 2013-01-10 | 39 | 换版 | 王彬彬 | |
| D/0 | 2014-01-06 | 39 | 更新 SGS 报告 | 王彬彬 | |
| E/0 | 2014-05-06 | 44 | 换版 | 张国信 | |
| F/0 | 2015-02-10 | 44 | 换版 | 张国信 | |
| G/0 | 2016-05-15 | 44 | 换版 | 张国信 | |
| H/0 | 2017-07-01 | 44 | 换版 | 张国信 | |
| I/0 | 2020-02-12 | 44 | 换版 | 张国信 | |
| J/0 | 2021-01-07 | 39 | 增加 0201 尺寸及 X6S\X7T 材质， 删除 1210 尺寸以上规格 | 张国信 | |
| J/1 | 2021-03-25 | 39 | 增加 0201 尺寸 C0G 规格型号 | 张国信 | |
| K/0 | 2022-03-18 | 39 | 换版 | 张国信 | |
| K/1 | 2022-06-28 | 41 | 换版 | 陈家锐 | |
| | | | | | |



CCTC
三环集团

潮州三环（集团）股份有限公司
Chaozhou Three-Circle (Group) Co., Ltd.

地址：广东省潮州市凤塘三环工业城 邮编(Post Code)：515646
ADD：San Huan Industrial District ,Feng Tang Chao Zhou, GuangDong, China

| | |
|----------------------------|------------------|
| 产品标准书 | 编号 Document No. |
| SPECIFICATION FOR APPROVAL | DRAAW108K/1-2022 |

目录

| | |
|---------------------|-----|
| 1. 电容器及介质分类..... | 3 |
| 2. 产品结构..... | 4 |
| 3. 产品规格型号命名规则..... | 5 |
| 4. 产品容量范围..... | 6 |
| 0201 (0603) 尺寸..... | 6 |
| 0402 (1005) 尺寸..... | 7 |
| 0603 (1608) 尺寸..... | 8 |
| 0805 (2012) 尺寸..... | 90 |
| 1206 (3216) 尺寸..... | 101 |
| 1210 (3225) 尺寸..... | 124 |
| 1812 (4532) 尺寸..... | 12 |
| 2220 (5750) 尺寸..... | 126 |
| 5. 产品尺寸..... | 157 |
| 6. 技术要求和测试条件..... | 169 |
| 7. 产品包装..... | 30 |
| 8. MLCC 使用注意事项..... | 335 |



CCTC
三环集团

潮州三环（集团）股份有限公司
Chaozhou Three-Circle (Group) Co., Ltd.

地址：广东省潮州市凤塘三环工业城

邮编(Post Code)：515646

ADD：San Huan Industrial District ,Feng Tang Chao Zhou, GuangDong, China

| | |
|----------------------------|------------------|
| 产品标准书 | 编号 Document No. |
| SPECIFICATION FOR APPROVAL | DRAAW108K/1-2022 |

1. 电容器及介质分类 Types of Capacitor and Dielectric Material

※COG：此类介质材料的电容器为 I 类电容器，包括常规、中高压 COG 产品。此类产品电性能稳定，几乎不随温度、电压和时间的变化而变化。适用于低损耗，稳定性要求高的电路中，如滤波器、谐振器和计时电路中。

※COG： The capacitor of this kind dielectric material is considered as Class I capacitor, including general capacitor and high frequency COG capacitor. The electrical properties of COG capacitor are the most stable one and have little change with temperature, voltage and time. They are suited for applications where low-losses and high-stability are required, such as filters, oscillators, and timing circuits.

※X7R、X7S、X7T、X6R、X6S、X6T、X5R：此类介质材料的电容器为 II 类电容器，具有较高的介电常数，容量比 I 类电容器高，具有较稳定的温度特性，适用于容量范围广，稳定性要求不高的电路中，如隔直、耦合、旁路、鉴频等电路中。

※ X7R、X7S、X7T、X6R、X6S、X6T、X5R： material is a kind of material has high dielectric constant. The capacitor made of this kind material is considered as Class II capacitor whose capacitance is higher than that of class I. These capacitors are classified as having a semi-stable temperature characteristic and used over a wide temperature range, such in these kinds of circuits, DC-blocking, decoupling, bypassing, frequency discriminating etc.



CCTC
三环集团

潮州三环（集团）股份有限公司
Chaozhou Three-Circle (Group) Co., Ltd.

地址：广东省潮州市凤塘三环工业城

邮编(Post Code)：515646

ADD：San Huan Industrial District ,Feng Tang Chao Zhou, GuangDong, China

| | |
|-------------------------------------|------------------|
| 产品标准书 SPECIFICATION FOR APPROVAL | 编号 Document No. |
| | DRAAW108K/1-2022 |

2. 产品结构 Product Frame

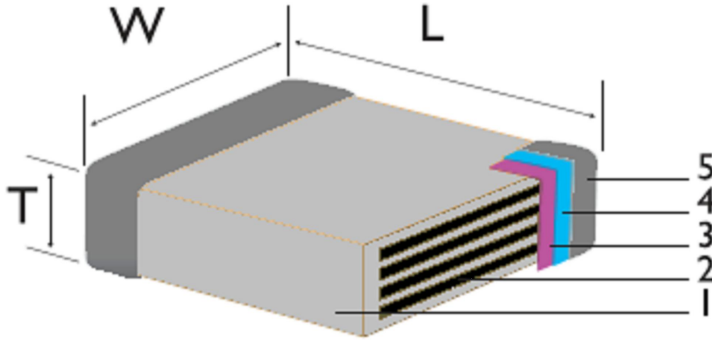

| 序号 No: | 名称 Name |
|-----------|----------------------------|
| 1 | 陶瓷介质 Ceramic dielectric |
| 2 | 内电极 Inner electrode |
| 3 | 外电极 Outer electrode |
| 4 | 镍层 Nickel |
| 5 | 锡层 Tin |



| | |
|-------------------------------------|--|
| 产品标准书 SPECIFICATION FOR APPROVAL | 编号 Document No. DRAAW108K/1-2022 |
|-------------------------------------|--|

3. 产品规格型号命名规则

General Product Parts Numbering System

(例) (example)



产品的介质特性组别

| 材质 | 工作温度范围 | 温度系数或温度特性 |
|-----|------------|-----------|
| C0G | -55℃~+125℃ | 0±30ppm/℃ |
| X7R | -55℃~+125℃ | ±15% |
| X7S | -55℃~+125℃ | ±22% |
| X7T | -55℃~+125℃ | +22/-33% |
| X6R | -55℃~+105℃ | ±15% |
| X6S | -55℃~+105℃ | ±22% |
| X6T | -55℃~+105℃ | +22/-33% |
| X5R | -55℃~+85℃ | ±15% |



| | |
|-------------------------------------|------------------|
| 产品标准书 SPECIFICATION FOR APPROVAL | 编号 Document No. |
| | DRAAW108K/1-2022 |

5. 产品尺寸 Dimensions

规格：0201、0402、0603、0805、1206、1210、1812、2220。

Chip Size：0201、0402、0603、0805、1206、1210、1812、2220。



| 规格 Type | L | W | e | g min | T (mm) /代码 Code | |
|------------|----------------|----------------|----------|-------|-----------------|---|
| | (mm) | (mm) | (mm) | (mm) | | |
| 0201 | 0.60±0.03 | 0.30±0.03 | 0.1~0.2 | 0.2 | 0.30±0.03 | Z |
| 0201*2 | 0.60-0.03/+0.1 | 0.30-0.03/+0.1 | 0.1~0.2 | 0.2 | 0.30-0.03/+0.1 | Z |
| 0402 | 1.00±0.10 | 0.50±0.10 | 0.15~0.3 | 0.4 | 0.50±0.10 | A |
| 0402*2 | 1.00-0.05/+0.2 | 0.50-0.05/+0.2 | 0.15~0.3 | 0.4 | 0.50-0.05/+0.2 | A |
| 0603 | 1.60±0.10 | 0.80±0.10 | 0.2~0.6 | 0.5 | 0.80±0.10 | C |
| 0603*1 | 1.60±0.20*1 | 0.80±0.20*1 | 0.2~0.6 | 0.5 | 0.80±0.20*1 | C |
| 0603*3 | 1.60-0/+0.3 | 0.80-0/+0.3 | 0.2~0.6 | 0.5 | 0.80-0/+0.3 | C |
| 0805 | 2.00±0.10 | 1.25±0.10 | 0.2~0.7 | 0.7 | 0.60±0.10 | B |
| | | | | | 0.85±0.10 | D |
| | | | | | 1.25±0.20 | F |
| 0805*1 | 2.00±0.20*1 | 1.25±0.20*1 | 0.2~0.7 | 0.7 | 0.60±0.10 | B |
| | | | | | 0.85±0.20 | D |
| | | | | | 1.25±0.20 | F |
| 1206 | 3.20±0.20 | 1.60±0.20 | 0.3~0.8 | 1.6 | 0.85±0.10 | D |
| | | | | | 1.00±0.10 | E |
| | | | | | 1.25±0.20 | F |
| | | | | | 1.60±0.20 | H |
| 1206*1 | 3.20±0.30*1 | 1.60±0.30*1 | 0.3~0.8 | 1.6 | 0.85±0.10 | D |
| | | | | | 1.00±0.10 | E |
| | | | | | 1.25±0.20 | F |
| | | | | | 1.60±0.30*1 | H |

*1 标识该规格型号标识为 1uF 及以上规格产品尺寸。

*2 标识该规格型号标识为 100nF 及以上规格产品尺寸。

*3 标识该规格型号标识为 10uF 及以上规格产品尺寸。



CCTC
三环集团

潮州三环（集团）股份有限公司
Chaozhou Three-Circle (Group) Co., Ltd.

地址：广东省潮州市凤塘三环工业城

邮编(Post Code)：515646

ADD：San Huan Industrial District ,Feng Tang Chao Zhou, GuangDong, China

| | |
|-------------------------------------|------------------|
| 产品标准书 SPECIFICATION FOR APPROVAL | 编号 Document No. |
| | DRAAW108K/1-2022 |

| 规格 Type | L (mm) | W (mm) | e (mm) | g min (mm) | T (mm) /代码 Code | |
|------------|-------------|------------|-----------|---------------|-----------------|-----------|
| | 1210 | 3.20±0.30 | 2.5±0.20 | 0.3~0.8 | 1.6 | 0.85±0.10 |
| 1.25±0.20 | | | | | | F |
| 1.60±0.20 | | | | | | H |
| 2.00±0.20 | | | | | | G |
| 2.50±0.30 | | | | | | M |
| 1210*1 | 3.20±0.40*1 | 2.5±0.30*1 | 0.3~0.8 | 1.6 | 0.85±0.10 | D |
| | | | | | 1.25±0.20 | F |
| | | | | | 1.60±0.30 | H |
| | | | | | 2.00±0.30 | G |
| 1812 | 4.50±0.30 | 3.2±0.30 | 0.3~1.5 | 2.5 | 1.25±0.20 | F |
| | | | | | 1.60±0.20 | H |
| | | | | | 2.00±0.20 | G |
| | | | | | 2.50±0.30 | M |
| 1812*1 | 4.50±0.40*1 | 3.2±0.40*1 | 0.3~1.5 | 2.5 | 1.25±0.20 | F |
| | | | | | 1.60±0.20 | H |
| | | | | | 2.00±0.20 | G |
| | | | | | 2.50±0.30 | M |
| 2220 | 5.70±0.40 | 5.0±0.40 | 0.3~1.1 | 3.5 | 1.25±0.20 | F |
| | | | | | 1.60±0.20 | H |
| | | | | | 2.00±0.20 | G |
| | | | | | 2.50±0.30 | M |

*1 标识该规格型号标识为 1uF 及以上规格产品尺寸。



| | |
|-------------------------------------|------------------|
| 产品标准书 SPECIFICATION FOR APPROVAL | 编号 Document No. |
| | DRAAW108K/1-2022 |

6. 技术要求和测试条件 Specification and Test Condition

6.1 外观 Appearance

| 类型 Dielectrics | 技术要求 Specification | 测试条件 Testing Condition |
|-------------------------------------|---|----------------------------|
| COG/X7R/X5R/X7T /X6S/X6R/X7S/X6T | 1/10L<L≤1/8L,1/10W<W≤1/8W, 1/10T<T≤1/8T (任意一项不符合, 均判定不合格) 1/10L<L≤1/8L,1/10W<W≤1/8W, 1/10T<T≤1/8T (None is acceptable, All judged unqualified) | 目视检查 Visual inspection. |

6.2 尺寸 Dimensions

| 类型 Dielectrics | 技术要求 Specification | 测试条件 Testing Condition |
|-------------------------------------|--|--------------------------------------|
| COG/X7R/X5R/X7T /X6S/X6R/X7S/X6T | 在要求的范围内 Within the specified dimensions | 用千分尺 Using calipers on micrometer |

6.3 容量 Capacitance

| 类型 Dielectrics | 技术要求 Specification | 测试条件 Testing Condition |
|-------------------------------------|---|---|
| COG | 在要求的容值容差范围内 Within the specified tolerance A:±0.05pF;B:±0.1pF;C:±0.25pF; D:±0.5pF;J: ±5% | 1.0±0.2Vrms, 1MHz±10% (C>1000 pF, 1.0±0.2Vrms, 1KHz±10%,) |
| X7R/X5R/X7T /X6S/X6R/X7S/ X6T | 在要求的容值容差范围内 Within the specified tolerance J: ±5%; K: ±10%; M: ±20% | 1.0±0.2Vrms, 1KHz±10% (Cp> 10uF,0.5±0.1Vrms,120±24Hz) |

备注：测试温度：25℃±3℃，测试湿度：<70%RH. 针对二类介质规格需去老化处理，条件：电容器在 150℃热处理 1 小时，放置 48h 后进行测量。



| | |
|-------------------------------------|-------------------------------------|
| 产品标准书 SPECIFICATION FOR APPROVAL | 编号 Document No. DRAAW108K/1-2022 |
|-------------------------------------|-------------------------------------|

6.4 损耗 Dissipation Factor

| 类型 Dielectrics | 技术要求 Specification | 测试条件 Testing Condition | | | | | | | | | | | | | | | | | | | | | | | | | | | | | | | | | | | | | | | | | | | | | | | | | | | | | | | | |
|--|--|---|---|-------------|----|------|---|--------------------------|------------|-----------------------|-------------|------|-------------------|--------------------------|------------|----------------|-----------------------|-------------|------|-------------------|-------------------------|------------|----------------|----------------------|-------------|------|-------------------|--------------------------|------------|----------------|-----------------------|-------------|------|-------------------|----------------------|------------|----------------|---|-------------|------|---|--------------------|------------|---------------------------------------|-------------|------|---|----------------------|------------|---|-------------|------|---|----------------------|------------|---|-------------|--|
| COG | $C_p < 30\text{pF}$, $Q \geq 400 + 20C_p$; $C_p \geq 30\text{pF}$, $Q \geq 1000$ | $1.0 \pm 0.2V_{rms}$, $1\text{MHz} \pm 10\%$, 25°C ($C_p > 1000\text{pF}$, $1.0 \pm 0.2V_{rms}$, $1\text{KHz} \pm 10\%$) | | | | | | | | | | | | | | | | | | | | | | | | | | | | | | | | | | | | | | | | | | | | | | | | | | | | | | | | |
| X7R/X5R/X7T /X6S/X6R/X7S/ X6T | <table border="1"> <thead> <tr> <th>规格</th> <th>U_R</th> <th>容量范围</th> <th>DF</th> </tr> </thead> <tbody> <tr> <td rowspan="2">0201</td> <td rowspan="2">/</td> <td>$C \leq 0.01\mu\text{F}$</td> <td>$\leq 7\%$</td> </tr> <tr> <td>$C > 0.01\mu\text{F}$</td> <td>$\leq 10\%$</td> </tr> <tr> <td rowspan="2">0402</td> <td>$\leq 25\text{V}$</td> <td>$C \leq 0.47\mu\text{F}$</td> <td>$\leq 7\%$</td> </tr> <tr> <td>$> 25\text{V}$</td> <td>$C > 0.47\mu\text{F}$</td> <td>$\leq 10\%$</td> </tr> <tr> <td rowspan="2">0603</td> <td>$\leq 25\text{V}$</td> <td>$C \leq 0.1\mu\text{F}$</td> <td>$\leq 7\%$</td> </tr> <tr> <td>$> 25\text{V}$</td> <td>$C > 0.1\mu\text{F}$</td> <td>$\leq 10\%$</td> </tr> <tr> <td rowspan="2">0805</td> <td>$\leq 25\text{V}$</td> <td>$C \leq 0.47\mu\text{F}$</td> <td>$\leq 7\%$</td> </tr> <tr> <td>$> 25\text{V}$</td> <td>$C > 0.47\mu\text{F}$</td> <td>$\leq 10\%$</td> </tr> <tr> <td rowspan="2">1206</td> <td>$\leq 25\text{V}$</td> <td>$C < 2.2\mu\text{F}$</td> <td>$\leq 7\%$</td> </tr> <tr> <td>$> 25\text{V}$</td> <td>$2.2\mu\text{F} \leq C < 47\mu\text{F}$</td> <td>$\leq 10\%$</td> </tr> <tr> <td rowspan="2">1210</td> <td rowspan="2">/</td> <td>$C < 1\mu\text{F}$</td> <td>$\leq 7\%$</td> </tr> <tr> <td>$1\mu\text{F} \leq C < 47\mu\text{F}$</td> <td>$\leq 10\%$</td> </tr> <tr> <td rowspan="2">1812</td> <td rowspan="2">/</td> <td>$C < 2.2\mu\text{F}$</td> <td>$\leq 7\%$</td> </tr> <tr> <td>$2.2\mu\text{F} \leq C < 47\mu\text{F}$</td> <td>$\leq 10\%$</td> </tr> <tr> <td rowspan="2">2220</td> <td rowspan="2">/</td> <td>$C < 2.2\mu\text{F}$</td> <td>$\leq 7\%$</td> </tr> <tr> <td>$2.2\mu\text{F} \leq C < 47\mu\text{F}$</td> <td>$\leq 10\%$</td> </tr> </tbody> </table> | 规格 | U_R | 容量范围 | DF | 0201 | / | $C \leq 0.01\mu\text{F}$ | $\leq 7\%$ | $C > 0.01\mu\text{F}$ | $\leq 10\%$ | 0402 | $\leq 25\text{V}$ | $C \leq 0.47\mu\text{F}$ | $\leq 7\%$ | $> 25\text{V}$ | $C > 0.47\mu\text{F}$ | $\leq 10\%$ | 0603 | $\leq 25\text{V}$ | $C \leq 0.1\mu\text{F}$ | $\leq 7\%$ | $> 25\text{V}$ | $C > 0.1\mu\text{F}$ | $\leq 10\%$ | 0805 | $\leq 25\text{V}$ | $C \leq 0.47\mu\text{F}$ | $\leq 7\%$ | $> 25\text{V}$ | $C > 0.47\mu\text{F}$ | $\leq 10\%$ | 1206 | $\leq 25\text{V}$ | $C < 2.2\mu\text{F}$ | $\leq 7\%$ | $> 25\text{V}$ | $2.2\mu\text{F} \leq C < 47\mu\text{F}$ | $\leq 10\%$ | 1210 | / | $C < 1\mu\text{F}$ | $\leq 7\%$ | $1\mu\text{F} \leq C < 47\mu\text{F}$ | $\leq 10\%$ | 1812 | / | $C < 2.2\mu\text{F}$ | $\leq 7\%$ | $2.2\mu\text{F} \leq C < 47\mu\text{F}$ | $\leq 10\%$ | 2220 | / | $C < 2.2\mu\text{F}$ | $\leq 7\%$ | $2.2\mu\text{F} \leq C < 47\mu\text{F}$ | $\leq 10\%$ | $1.0 \pm 0.2V_{rms}$, $1\text{KHz} \pm 10\%$, ($C_p > 10\mu\text{F}$, $0.5 \pm 0.1V_{rms}$, $120 \pm 24\text{Hz}$) |
| | 规格 | U_R | 容量范围 | DF | | | | | | | | | | | | | | | | | | | | | | | | | | | | | | | | | | | | | | | | | | | | | | | | | | | | | | |
| | 0201 | / | $C \leq 0.01\mu\text{F}$ | $\leq 7\%$ | | | | | | | | | | | | | | | | | | | | | | | | | | | | | | | | | | | | | | | | | | | | | | | | | | | | | | |
| | | | $C > 0.01\mu\text{F}$ | $\leq 10\%$ | | | | | | | | | | | | | | | | | | | | | | | | | | | | | | | | | | | | | | | | | | | | | | | | | | | | | | |
| | 0402 | $\leq 25\text{V}$ | $C \leq 0.47\mu\text{F}$ | $\leq 7\%$ | | | | | | | | | | | | | | | | | | | | | | | | | | | | | | | | | | | | | | | | | | | | | | | | | | | | | | |
| | | $> 25\text{V}$ | $C > 0.47\mu\text{F}$ | $\leq 10\%$ | | | | | | | | | | | | | | | | | | | | | | | | | | | | | | | | | | | | | | | | | | | | | | | | | | | | | | |
| | 0603 | $\leq 25\text{V}$ | $C \leq 0.1\mu\text{F}$ | $\leq 7\%$ | | | | | | | | | | | | | | | | | | | | | | | | | | | | | | | | | | | | | | | | | | | | | | | | | | | | | | |
| | | $> 25\text{V}$ | $C > 0.1\mu\text{F}$ | $\leq 10\%$ | | | | | | | | | | | | | | | | | | | | | | | | | | | | | | | | | | | | | | | | | | | | | | | | | | | | | | |
| | 0805 | $\leq 25\text{V}$ | $C \leq 0.47\mu\text{F}$ | $\leq 7\%$ | | | | | | | | | | | | | | | | | | | | | | | | | | | | | | | | | | | | | | | | | | | | | | | | | | | | | | |
| | | $> 25\text{V}$ | $C > 0.47\mu\text{F}$ | $\leq 10\%$ | | | | | | | | | | | | | | | | | | | | | | | | | | | | | | | | | | | | | | | | | | | | | | | | | | | | | | |
| | 1206 | $\leq 25\text{V}$ | $C < 2.2\mu\text{F}$ | $\leq 7\%$ | | | | | | | | | | | | | | | | | | | | | | | | | | | | | | | | | | | | | | | | | | | | | | | | | | | | | | |
| | | $> 25\text{V}$ | $2.2\mu\text{F} \leq C < 47\mu\text{F}$ | $\leq 10\%$ | | | | | | | | | | | | | | | | | | | | | | | | | | | | | | | | | | | | | | | | | | | | | | | | | | | | | | |
| | 1210 | / | $C < 1\mu\text{F}$ | $\leq 7\%$ | | | | | | | | | | | | | | | | | | | | | | | | | | | | | | | | | | | | | | | | | | | | | | | | | | | | | | |
| | | | $1\mu\text{F} \leq C < 47\mu\text{F}$ | $\leq 10\%$ | | | | | | | | | | | | | | | | | | | | | | | | | | | | | | | | | | | | | | | | | | | | | | | | | | | | | | |
| 1812 | / | $C < 2.2\mu\text{F}$ | $\leq 7\%$ | | | | | | | | | | | | | | | | | | | | | | | | | | | | | | | | | | | | | | | | | | | | | | | | | | | | | | | |
| | | $2.2\mu\text{F} \leq C < 47\mu\text{F}$ | $\leq 10\%$ | | | | | | | | | | | | | | | | | | | | | | | | | | | | | | | | | | | | | | | | | | | | | | | | | | | | | | | |
| 2220 | / | $C < 2.2\mu\text{F}$ | $\leq 7\%$ | | | | | | | | | | | | | | | | | | | | | | | | | | | | | | | | | | | | | | | | | | | | | | | | | | | | | | | |
| | | $2.2\mu\text{F} \leq C < 47\mu\text{F}$ | $\leq 10\%$ | | | | | | | | | | | | | | | | | | | | | | | | | | | | | | | | | | | | | | | | | | | | | | | | | | | | | | | |
| 备注：测试温度： $25^\circ\text{C} \pm 3^\circ\text{C}$ ，测试湿度： $< 70\%RH$ 。针对二类介质规格需去老化处理，条件：电容器在 150°C 热处理 1 小时，放置 48h 后进行测量。 | | | | | | | | | | | | | | | | | | | | | | | | | | | | | | | | | | | | | | | | | | | | | | | | | | | | | | | | | | |



| | |
|----------------------------|------------------|
| 产品标准书 | 编号 Document No. |
| SPECIFICATION FOR APPROVAL | DRAAW108K/1-2022 |

6.5 绝缘电阻 Insulation Resistance

| 类型 Dielectrics | 技术要求 Specification | 测试条件 Testing Condition |
|---|--|--|
| COG/X7R/X5R /X7T/X6S/X7S/ X6R/X6T | $U_R \leq 50V$, 大于 $10 G\Omega$ 或 $100\Omega \cdot F / CR$ (大于其中较小的数值) $U_R \leq 50V$, More than $10 G\Omega$ or $100\Omega \cdot F / CR$, whichever is smaller. | $U_R \leq 50V$ $U_{测} = U_R$; 充电时间: 60 ± 5 秒 温度: $25^\circ C$ Charge Time: 60 ± 5 sec Temperature: $25^\circ C$ |
| COG/X7R/X7T /X6S/X7S/X5R/ X6R/X6T | $U_R > 50V$, 大于 $4G\Omega$ 或 $100\Omega \cdot F / CR$ (大于其中较小的数值) $U_R > 50V$, More than $4 G\Omega$ or $100\Omega \cdot F / CR$, whichever is smaller. | $U_R \leq 400V$ $U_{测} = U_R$ $U_R > 400V$ $U_{测} = 400V$; 充电时间: 60 ± 5 秒 温度: $25^\circ C$ Charge Time: 60 ± 5 sec Temperature: $25^\circ C$ |

备注：测试温度： $25^\circ C \pm 3^\circ C$ ，测试湿度： $< 70\%RH$.

6.6 耐电压 Dielectric Strength

| 类型 Dielectrics | 额定电压范围 Rated voltage range | 耐电压性能测试方法 Measuring Method |
|--------------------------------------|----------------------------|---|
| COG | $U_R \leq 50V$ | 施加额定电压的 300%, 5 秒, 最大电流不超过 50mA Force 300% Rated voltage for 5 second. Max current should not exceed 50 mA. |
| X7R/X5R/X7T /X6S/X7S/X6R/X6T | $U_R \leq 50V$ | 施加额定电压的 250%, 5 秒, 最大电流不超过 50mA Force 250% Rated voltage for 5 second. Max current should not exceed 50 mA. |
| COG/X7R/X7S/X7T/ X5R /X6R/X6S/X6T | $100V \leq U_R < 500V$ | 施加额定电压的 200%, 5 秒, 最大电流不超过 50mA Force 200% Rated voltage for 5 second. Max current should not exceed 50 mA. |
| | $500V \leq U_R < 2000V$ | 施加额定电压的 150%, 5 秒, 最大电流不超过 50mA Force 150% Rated voltage for 5 second. Max current should not exceed 50 mA. |
| | $U_R \geq 2000V$ | 施加额定电压的 120%, 5 秒, 最大电流不超过 30mA Force 120% Rated voltage for 5 second. Max current should not exceed 30 mA. |



| | |
|----------------------------|------------------|
| 产品标准书 | 编号 Document No. |
| SPECIFICATION FOR APPROVAL | DRAAW108K/1-2022 |

6.7 静电容量温度特性 Temperature Coefficient of Capacitance

| 类型 Dielectrics | 技术要求 Specification | 测试条件 Testing Condition | | | | |
|--|---|---|---------------------|-------|-------|-------|
| COG | 容量变化在±30ppm/°C以内 容量漂移在±0.2% 或±0.05pF 以内 Temperature coefficient within ±30ppm/°C; Cp drift within ±0.2% or ±0.05pF | 按系列温度顺序测试电容容量 Measure capacitance under follow table list temperature: 在 140~150°C 预处理 1 小时，放置 24h 后进行测量。 | | | | |
| | | 步骤 STEP | COG, X7R,X7 T | X6S | X5R | X7S |
| | | 1 | 25 ±2 | 25 ±2 | 25 ±2 | 25 ±2 |
| | | 2 | -55±3 | -55±3 | -55±3 | -55±3 |
| | | 3 | 25 ±2 | 25 ±2 | 25 ±2 | 25 ±2 |
| X7R/X5R/X6 R | 容量变化在±15%以内 Capacitance change within ±15% | 4 | 125±3 | 105±3 | 85±3 | 125±3 |
| | | 5 | 25 ±2 | 25 ±2 | 25 ±2 | 25 ±2 |
| X7T/X6T | 容量变化在+22%, -33%以内 Capacitance change within +22%, -33% | 1) COG 容量漂移的计算方法为：用步骤 3 测量的电容容值量除以在第 1、3 和 5 步骤测量得到的误差的最大值和最小值的差。 温度系数的计算以第 3 步骤测量电容容量为参考。 | | | | |
| X6S/X7S | 容量变化在±22%以内 Capacitance change within ±22% | 2) X7R/X7S/ X7T /X5R/X6R/X6S/X6T 与 25°C 时的电容容量相比较，电容容量在温度范围内的变化在要求的范围之内。 | | | | |
| 备注：0201/223 及以上、0402/104 及以上规格、0603/334 及以上规格、0805/105 及以上规格、1206/1210 225 及以上规格，测试电压：<0.5V。 | | | | | | |



| | |
|----------------------------|------------------|
| 产品标准书 | 编号 Document No. |
| SPECIFICATION FOR APPROVAL | DRAAW108K/1-2022 |

6.8 附着力 Adhesion

| 类型 Dielectrics | 技术要求 Specification | 测试条件 Testing Condition |
|---|--|--|
| COG/X7R/X5R /X7T/X6S/X7S/ X6R/X6T | 端电极无松动，也无其它不良现象 No removal of the terminations or other defect shall occur. | 施加 6N 的压力，并保持 10±1 秒 The pressurizing force shall be 6N (=600g*f) and the duration of application shall be 10±1sec.  |

6.9 可焊性 Solderability of Termination

| 类型 Dielectrics | 技术要求 Specification | 测试条件 Testing Condition |
|---|--|---|
| COG/X7R/X5R /X7T/X6S/X7S/X6 R/X6T | 端电极挂锡面积不小于 95%，针孔或粗糙面积小于 5% 95% min. coverage of both terminal electrodes and less than 5% have pin holes or rough spots. | 锡炉温度：245±5℃ 浸入时间：2±1 秒 两侧端电极完全浸入焊锡炉 Solder temperature: 245±5℃ Dipping time: 2±1 seconds. Completely soak both terminal electrodes in solder |

6.10 耐焊性 Resistance to leaching

| 类型 Dielectrics | 技术要求 Specification | 测试条件 Testing Condition |
|---|--|--|
| COG/X7R/X5R /X7T/X6S/X7S/X6 R/X6T | 端电极挂锡面积不小于 95%，针孔或粗糙面积小于 5%，外观无开裂 95% min. coverage of both terminal electrodes and less than 5% have pin holes or rough spots. No remarkable visual damage. | 预热：120℃~150℃/60 秒 锡炉温度：270±5℃ 浸入时间：10±1 秒 两侧端电极完全浸入焊锡炉 Solder temperature: 270±5℃ preheated: 120℃~150℃/60sec Dipping time: 10±1 seconds. Completely soak both terminal electrodes in solder |



| | |
|----------------------------|------------------|
| 产品标准书 | 编号 Document No. |
| SPECIFICATION FOR APPROVAL | DRAAW108K/1-2022 |

6.11 端电极结合强度 Bending

| 类型 Dielectrics | 技术要求 Specification | 测试条件 Testing Condition |
|--|--|--|
| COG | 无可见损伤； 容量变化小于等于±5%或±0.5pF （取较大值） No remarkable visual damage Cp change within ±5.0% or ±0.5pF, whichever is larger. | 将片状电容器安装在测试夹具上，按图所示方向以 1.0mm/s 的速率施加压力，弯曲 1mm。 Solder the capacitor on testing substrate and put it on testing stand. The middle part of substrate shall successively be pressurized by pressuring rod at a rated of about 1.0mm/sec. Until the deflection become means of the 1.0mm. |
| X7R/X5R/X7T /X6S/X7S/X6R/ X6T | 无可见损伤； 容量变化小于等于±10% No remarkable visual damage Cp change ≤ ±10% | |
| 备注：测试样板厚度：0201/0402:1.0cm;0603/0805/1206:1.6cm | | |



| | |
|----------------------------|------------------|
| 产品标准书 | 编号 Document No. |
| SPECIFICATION FOR APPROVAL | DRAAW108K/1-2022 |

6.12 耐焊接热 Resistance to Soldering Heat

| 类型 Dielectrics | 技术要求 Specification | 测试条件 Testing Condition |
|---------------------------------|--|---|
| COG | 无明显可见损伤 容量变化在 $\pm 2.5\%$ 或 $\pm 0.25\text{pF}$ （取较大值）以内 DF 满足产品初始值的要求 IR 满足产品初始值的要求 No remarkable visual damage Cp change within $\pm 2.5\%$ or $\pm 0.25\text{pF}$, whichever is larger. DF meets initial standard value. IR meets initial standard value. | 焊接温度: $270\pm 5^\circ\text{C}$ 预热: $120\sim 150^\circ\text{C}$ 60 秒 浸入时间: 10 ± 1 秒 在室温下放置 24 ± 2 (COG) 或 48 ± 4 (X7R/X7S/X7T/X5R/X6R/X6S/X6T) 小时以后测量 试验后在标准条件下恢复 *高介电常数电容器的初始值测量 在 $140\sim 150^\circ\text{C}$ 进行 1 小时的热处理后在室温下放置 48 ± 4 小时 测量初始值 Soldering temperature: $270\pm 5^\circ\text{C}$ Preheating: $120\sim 150^\circ\text{C}$ 60sec. Dipping time: 10 ± 1 seconds. |
| X7R/X7S/X7T/X5R/ X6R/X6S/X6T | 无明显可见损伤 容量变化在 $\pm 7.5\%$ 以内 DF 满足产品初始值的要求 IR 满足产品初始值的要求 No remarkable visual damage Cp change within $\pm 7.5\%$ DF meets initial standard value. IR meets initial standard value. | Measurement to be made after being kept at room temperature for 24 ± 2 (COG) or 48 ± 4 (X7R/X7S/X7T/X5R/X6R/X6S/X6T) hours. Recovery for the following period under the standard condition after test. *Initial measurement for high dielectric constant type Perform a heat treatment at $140\sim 150^\circ\text{C}$ for 1hr and let sit for 48 ± 4 hrs at room temperature. Perform the initial measurement. |



| | |
|----------------------------|------------------|
| 产品标准书 | 编号 Document No. |
| SPECIFICATION FOR APPROVAL | DRAAW108K/1-2022 |

6.13 温度快速循环 Temperature Cycle

| 类型 Dielectrics | 技术要求 Specification | 测试条件 Testing Condition | | |
|-------------------------------------|--|---|--------------------|-------------|
| COG | 无明显可见损伤 容量变化在±2.5%或 ±0.25pF（取较大值）以内 No remarkable visual damage Cp change within ±2.5% or ±0.25pF, whichever is larger. | 按下列步骤进行 5 次循环： To perform 5 cycles of the stated environment | | |
| | | 步 骤 Step | 温 度 Temperature | 时 间 Time |
| | | 1 | 下限类别温度 +0/-3℃ | 30min |
| | | 2 | 25℃ | 2~3 min |
| | | 3 | 上限类别温度 +3/-0℃ | 30 min |
| X7R/X5R/X7T /X6S/X7S/X6R/X 6T | 无明显可见损伤 容量变化在±7.5%以内 No remarkable visual damage Cp change within ±7.5% | 4 | 25℃ | 2~3 min |
| | | 在室温下放置 24±2 (COG) 或 48±4(X7R/X7S/X7T/X5R/X6R/X6S/X6T)小时以后测量 *高介电常数电容器的初始值测量在 140~150℃进行 1 小时的热处理后在室温下放置 48±4 小时 测量初始值 Measurement to be made after being kept at room temperature for 24±2hrs (COG) or 48±4hrs (X7R/X7S/X7T/X5R/X6R/X6S/X6T) at room temperature, then measure. *Initial measurement for high dielectric constant type Perform a heat treatment at 140~150℃ for 1hr and let sit for 48±4hrs at room temperature. Perform the initial measurement. | | |



| | |
|----------------------------|------------------|
| 产品标准书 | 编号 Document No. |
| SPECIFICATION FOR APPROVAL | DRAAW108K/1-2022 |

6.14 稳态湿热 Moisture Resistance ,steady state

| 类型 Dielectrics | 技术要求 Specification | 测试条件 Testing Condition |
|-------------------------------------|--|--|
| COG | 外观无明显可见损伤 容量变化在±5%或 ±0.5pF（取较大值）以内 $C_p < 10\text{pF}$, $Q \geq 200 + 10C_p$; $10 \leq C_p < 30\text{pF}$, $Q \geq 275 + 2.5C_p$ $C_p \geq 30\text{pF}$, $Q \geq 350$ IR: 大于 1000MΩ或 10Ω·F(取较小值) No remarkable visual damage Cp change within ±5% or ±0.5pF, whichever is larger. $C_p < 10\text{pF}$, $Q \geq 200 + 10C_p$; $10 \leq C_p < 30\text{pF}$, $Q \geq 275 + 2.5C_p$ $C_p \geq 30\text{pF}$, $Q \geq 350$ $R * C \geq 1000\text{M}\Omega$ or 10Ω·F, whichever is smaller | 测试温度: 40±2℃ 湿度: 90~95% RH 测试时间: 500 ±12hrs 在室温下放置 24±2 (COG) 或 48±4(X7R/X7S/X7T/X5R/X6R/X6S/X6T) 小时以后测量 *高介电常数电容器的初始值测量 在 140~150℃进行 1 小时的热处理后在室温下放置 48±4 小时 测量初始值 Test temperature: 40±2℃ Humidity: 90~95% RH Testing time: 500 ±12hrs Measurement to be made after being kept at room temperature for 24±2hrs (COG) or 48±4hrs (X7R/X7S/X7T/X5R/X6R/X6S/X6T) |
| X7R/X7S/X7T/ X5R /X6R/X6S/X6T | 外观无明显可见损伤 容量变化在±12.5%以内 DF 为初始值的 2 倍以下 IR:大于 1000MΩ或 10Ω·F(取较小值) Cp change within ±12.5% DF:Not more than 2 times of initial value $R * C \geq 1000\text{M}\Omega$ or 10Ω·F, whichever is smaller | *Initial measurement for high dielectric constant type Perform a heat treatment at 140~150℃ for 1hr and let sit for 48±4hrs at room temperature. Perform the initial measurement. |



| | |
|----------------------------|------------------|
| 产品标准书 | 编号 Document No. |
| SPECIFICATION FOR APPROVAL | DRAAW108K/1-2022 |

6.15 耐湿负荷 Damp heat with load

| 类型 Dielectrics | 技术要求 Specification | 测试条件 Testing Condition |
|-------------------------------------|--|---|
| COG | 外观无明显可见损伤 容量变化在 $\pm 7.5\%$ 或 $\pm 0.75\text{pF}$ （取较大值）以内 $C_p < 30\text{pF}$, $Q \geq 100 + 10/3 \cdot C_p$ $C_p \geq 30\text{pF}$, $Q \geq 200$ IR: 大于 $500\text{M}\Omega$ 或 $5\Omega \cdot \text{F}$ (取较小值) No remarkable visual damage $C_p \text{ change} \leq \pm 7.5\% \text{ or } \pm 0.75\text{pF}$, whichever is larger. $C_p < 30\text{pF}$, $Q \geq 100 + 10/3 \cdot C_p$ $C_p \geq 30\text{pF}$, $Q \geq 200$ $R \cdot C \geq 500\text{M}\Omega \text{ or } 5\Omega \cdot \text{F}$, whichever is smaller | 测试温度: $40 \pm 2^\circ\text{C}$ 湿度: 90~95% RH 电压: 额定电压 测试时间: $500 \pm 12\text{hrs}$ 在室温下放置 24 ± 2 (COG) 或 48 ± 4 (X7R/X7S/X7T/X5R/X6R/X6S/X6T) 小时以后测量 *在 $40 \pm 2^\circ\text{C}$ 温度下, 将电容器加额定直流电压 1hrs. 去掉电压, 将电容器在室温下放置 $48 \pm 4\text{hrs}$ 测量初始电容值。 Test temperature: $40 \pm 2^\circ\text{C}$ |
| X7R/X7S/X7T/ X5R /X6R/X6S/X6T | 外观无明显可见损伤 容量变化在 $\pm 12.5\%$ 以内 DF 为初始值的 2 倍以下 IR: 大于 $500\text{M}\Omega$ 或 $5\Omega \cdot \text{F}$ (取较小值) No remarkable visual damage $C_p \text{ change} \leq \pm 12.5\%$ DF: Not more than 2 times of initial value $R \cdot C \geq 500\text{M}\Omega \text{ or } 5\Omega \cdot \text{F}$, whichever is smaller | Humidity: 90~95% RH Voltage: 100% of the rated voltage Testing time: $500 \pm 12\text{hrs}$ Measurement to be made after being kept at room temperature for $24 \pm 2\text{hrs}$ (COG) or $48 \pm 4\text{hrs}$ (X7R/X7S/X7T/X5R/X6R/X6S/X6T) *Apply the rated DC voltage for 1 hour at $40 \pm 2^\circ\text{C}$. Remove and let sit for $48 \pm 4\text{hrs}$ at room temperature. Perform the initial measurement. |

备注：该项可靠性试验仅适用于常规产品，不适用于中高压产品。



| | |
|----------------------------|------------------|
| 产品标准书 | 编号 Document No. |
| SPECIFICATION FOR APPROVAL | DRAAW108K/1-2022 |

6.16 耐久性 Life Test

| 类型 Dielectrics | 技术要求 Specification | 测试条件 Testing Condition |
|-------------------------------------|--|---|
| COG | 外观无明显可见损伤 容量变化在±3%或±0.3pF（取较大值）以内 容量在 30pF 以上， $Q \geq 350$ 容量在 10pF 以上且小于 30 pF， $Q \geq 275 + (2.5 * C_p)$ 容量小于 10pF, $Q \geq 200 + 10 * C_p$ IR: 大于 1000MΩ或 5Ω·F(取较小值) No remarkable visual damage Cp change ≤ ±3% or ±0.3pF, whichever is larger. $Q \geq 350$ ($C_p \geq 30$ pF) $Q \geq 275 + (2.5 * C_p)$ (10 pF ≤ C_p < 30 pF) $Q \geq 200 + 10 * C_p$ (C_p < 10 pF) $R * C \geq 1000M\Omega$ or 5Ω·F, whichever is smaller | 测试温度：上限类别温度±3℃ 电压： $U_R < 100V$ 1.5 倍额定电压(*见备注) 测试时间: 1000 小时 在室温下放置 24±2 (COG) 或 48±4(X7R/X7S/X7T/X5R/X6R/X6S/X6T) 小时以后测量 *高介电常数电容器的初始值测量 在上限类别温度±3℃，将电容器加 1.5 倍额定直流电压 1 小时 去掉电压，将电容器在室温下放置 48±4hrs 测量初始电容值 Test temperature: Max. Operating Temp. ±3℃ Voltage: $U_R < 100V$ 150% of the rated voltag (*Remarks) Testing time: 1000 hrs |
| X7R/X7S/X7T/ X5R /X6R/X6S/X6T | 外观无明显可见损伤 容量变化在±12.5%以内 DF 为初始值的 2 倍以下 IR: 大于 1000MΩ或 5Ω·F(取较小值) No remarkable visual damage Cp change ≤ ±12.5% DF: Not more than 2 times of initial value $R * C \geq 1000M\Omega$ or 5Ω·F, whichever is smaller | Measurement to be made after being kept at room temperature for 24±2hrs (COG) or 48±4hrs (X7R/X7S/X7T/X5R/X6R/X6S/X6T) *Initial measurement for high dielectric constant type Apply 150% of the rated DC voltage for one hour at the maximum operating temperature ±3℃. Remove and let sit for 48±4hrs at room temperature. Perform the initial measurement |

备注：该项可靠性试验仅适用于常规产品，不适用于中高压产品。

备注*：0201/104 及以上规格、0402/104 及以上规格、0603/105 及以上规格、0805/225 及以上规格、1206/475 及以上规格、1210/225 及以上规格，按照 1 倍额定电压测试。



| | |
|-------------------------------------|------------------|
| 产品标准书 SPECIFICATION FOR APPROVAL | 编号 Document No. |
| | DRAAW108K/1-2022 |

7. 产品包装 Packing

7.1 袋式散装 Bulk Packing

10K 个/袋或按客户要求。Standard packing 10Kpcs/bag; others are according to customer request.

7.2 编带式包装 Tape Packing

| 规格 Type | 尺寸 Size (mm) | | | 编带数量(个/盘 pcs/reel) | |
|------------|--------------|------|-----------------|--------------------|------------------|
| | 长度 L | 宽度 W | 厚度 T | 纸带 Paper Tape | 塑料带 Plastic Tape |
| 0201 | 0.6 | 0.3 | 0.3 | 15,000 | N/A |
| 0402 | 1.0 | 0.5 | 0.5 | 10,000 | N/A |
| 0603 | 1.6 | 0.8 | 0.8 | 4,000 | N/A |
| 0805 | 2.0 | 1.25 | ≤0.85 | 4,000 | N/A |
| | | | >0.85 | N/A | 3,000 |
| 1206 | 3.2 | 1.6 | ≤0.85 | 4,000 | N/A |
| | | | 0.85 < T ≤ 1.25 | N/A | 3,000 |
| | | | 1.6 | N/A | 2,000 |
| 1210 | 3.2 | 2.5 | ≤2.0 | N/A | 2,000 |
| | | | >2.0 | N/A | 1,500 |
| 1812 | 4.6 | 3.2 | ≤2.0 | N/A | 1,000 |
| | | | >2.0 | N/A | 1,000 |
| 2220 | 5.7 | 5.0 | ≤1.25 | N/A | 1,000 |
| | | | >1.25 | N/A | 500 |

7.2.1 纸带尺寸 Dimensions of Packing Paper



| Type | A | B | C | D | T |
|------|-----------|-----------|----------|----------|---------|
| 0201 | 0.36±0.03 | 0.67±0.03 | 2.0±0.10 | 2.0±0.05 | 0.42max |
| 0402 | 0.65±0.10 | 1.15±0.10 | 2.0±0.05 | 2.0±0.05 | 0.8max |
| 0603 | 1.05±0.10 | 1.85±0.10 | 4.0±0.10 | 2.0±0.10 | 1.1max |
| 0805 | 1.55±0.15 | 2.3±0.15 | 4.0±0.10 | 2.0±0.10 | 1.1max |
| 1206 | 1.95±0.15 | 3.5±0.15 | 4.0±0.10 | 2.0±0.10 | 1.1max |

(单位 unit:毫米 mm)



| | |
|-------------------------------------|------------------|
| 产品标准书 SPECIFICATION FOR APPROVAL | 编号 Document No. |
| | DRAAW108K/1-2022 |

7.2.2 塑料带尺寸 Dimensions of Embossed Packing

8mm宽，4mm间距编带

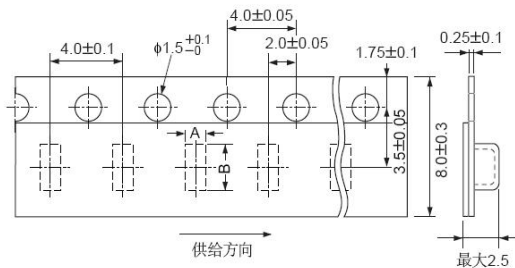

12mm宽，8mm/4mm间距编带



- A: 1.45 ± 0.20 B: 2.25 ± 0.20 (0805) A: 1.95 ± 0.20 B: 3.50 ± 0.20 (1206)
 A: 2.90 ± 0.20 B: 3.60 ± 0.20 (1210) A: 3.60 ± 0.20 B: 4.90 ± 0.20 (1812)
 A: 5.40 ± 0.20 B: 6.10 ± 0.20 (2220)

(单位 unit:毫米 mm)

7.2.3 编带盘尺寸 Dimensions of Reel

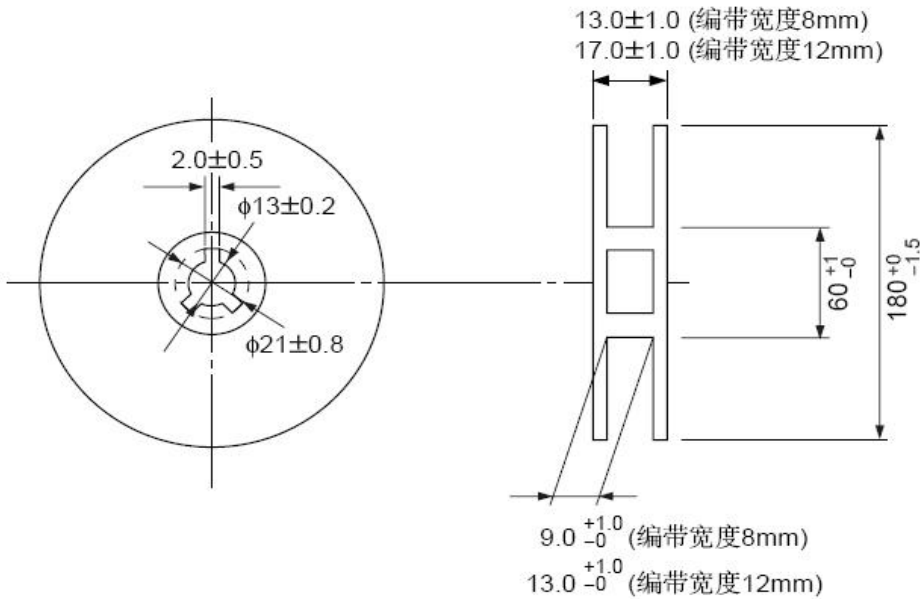

7.2.4 编带方式 Taping Figure





| | |
|----------------------------|------------------|
| 产品标准书 | 编号 Document No. |
| SPECIFICATION FOR APPROVAL | DRAAW108K/1-2022 |

空白部分 Empty section 产品装入部分 Chip insertion section 空白部分 Empty section



7.2.5 编带方法 Taping Method

- ① 包装电容器的编带是顺时针卷绕的，由上往下的方向拉出编带时，传送孔处于编带的右侧。
- ② 在编带的前端，至少留出 5 个间距的引出带。
- ③ 在编带时，必须按下图留出引带部分或空白部分。
- ④ 在盘带的安装中的产品装错的数量每盘必须小于表示数量的 0.1% 或 1 个为限，不连续发生错误。
- ⑤ 上胶带和下胶带不应超出编带的边缘，不能挡住传送孔。
- ⑥ 传送孔的累计误差为 10 个间距： ± 0.3 毫米以内。
- ⑦ 上胶带的剥离力矩应在 0.1 至 0.6 牛顿以内，其方向如下图所示。

- ① Tapes for capacitors are wound clockwise. The sprocket holes are to the right as the tape is pulled toward the user.
- ② The top tape and base tape are not attached at the end of the tape for a minimum of 5 pitches.
- ③ Part of the leader and part of the empty tape shall be attached to the end of the tape as follows.
- ④ Missing capacitors number within 0.1% of the number per reel or 1pc, whichever is greater, and are not continuous.
- ⑤ The top tape and bottom tape shall not protrude beyond the edges of the tape and shall not cover sprocket holes.
- ⑥ Cumulative tolerance of sprocket holes, 10 pitches: ± 0.3 mm.
- ⑦ Peeling off force: 0.1 to 0.6N in the direction shown down.





| | |
|-------------------------------------|-------------------------------------|
| 产品标准书 SPECIFICATION FOR APPROVAL | 编号 Document No. DRAAW108K/1-2022 |
|-------------------------------------|-------------------------------------|

7.2.6 产品标签 Reel Label

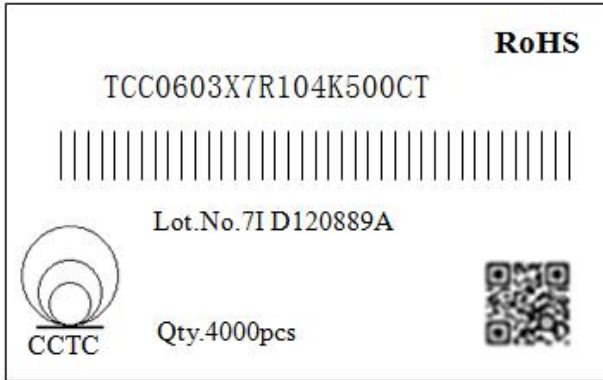

标签内容 The Contents of Label

(1) TCC 0603 X7R 104 K 500 C T

① ② ③ ④ ⑤ ⑥ ⑦ ⑧

①陶瓷电容器代号 Code of Ceramic Capacitor, ②尺寸 chip size, ③温度特性 dielectrics, ④容量 capacitance, ⑤容量容差 tolerance, ⑥额定电压 rated voltage, ⑦厚度 thickness, ⑧包装 packing

(2) 产品批号 Lot. No.: 7ID120889A

(3) 数量 Qty: 4000pcs

(4) RoHS: GREEN PARTS 绿色物料

7.2.7.外包装 Package

7.2.7.1 包装箱 Carton

7.2.7.1.1 包装箱尺寸 Carton Size

| L | W | H |
|--------|--------|--------|
| 41.0cm | 38.5cm | 20.2cm |

7.2.7.1.2 数量: 240Kpcs /箱 The Quantity: 240Kpcs /one carton

1 内包装盒=40,000PCS 1 INNER BOX=40,000PCS

1 包装箱 =40,000PCS × 6 包装盒=240,000PCS 1 CARTON=40,000PCS × 6 INNER BOX =240,000PCS

RoHS 标识(根据客户要求张贴) according to customer request



CCTC
三环集团

潮州三环（集团）股份有限公司
Chaozhou Three-Circle (Group) Co., Ltd.

地址：广东省潮州市凤塘三环工业城

邮编(Post Code)：515646

ADD：San Huan Industrial District ,Feng Tang Chao Zhou, GuangDong, China

| | |
|-------------------------------------|-------------------------------------|
| 产品标准书 SPECIFICATION FOR APPROVAL | 编号 Document No. DRAAW108K/1-2022 |
|-------------------------------------|-------------------------------------|

7.2.7.2 内包装盒 Inner Box

7.2.7.2.1 包装盒尺寸 Size

| | | |
|--------|-------|------|
| L | W | H |
| 18.5cm | 6.5cm | 19cm |

7.2.7.2.2 数量：40Kpcs /盒

1 盘=4000PCS 1 REEL=4,000PCS

1 包装盒=4,000PCS × 10 盘 =40,000PCS 1 INNER BOX=4,000PCS × 10REEL =40,000PCS



| | |
|----------------------------|------------------|
| 产品标准书 | 编号 Document No. |
| SPECIFICATION FOR APPROVAL | DRAAW108K/1-2022 |

8. MLCC 使用注意事项 Precautions on the use of MLCC

8.1 电路板设计 PCB Design

8.1.1 电路板图案设计 Design of Land-patterns

下面图和表格给出了部分推荐的设计图案，可以防止安装时焊锡量过多。

同时也给出了不正确的图案。

The following diagrams and tables show some examples recommended patterns to prevent excessive solder amounts (larger fillets which above the component end terminations)

Examples of improper pattern designs are also shown.

电路板设计推荐图案尺寸：

Recommended land dimensions for a typical chip capacitor land patterns for PCBs

波峰焊接时推荐设计的尺寸 (单位: mm):

Recommended land dimensions for wave-soldering (unit: mm)

| 规格 SIZE | | 0603 | 0805 | 1206 |
|---------|---|---------|---------|---------|
| 尺寸 | L | 1.6 | 2.0 | 3.2 |
| | W | 0.8 | 1.25 | 1.6 |
| A | | 0.8~1.0 | 1.0~1.4 | 1.8~2.5 |
| B | | 0.5~0.8 | 0.8~1.5 | 0.8~1.7 |
| C | | 0.6~0.8 | 0.9~1.2 | 1.2~1.6 |



再流焊接时推荐设计的尺寸 (单位: mm)

Recommended land dimensions for reflow-soldering (unit: mm)

| 规格 SIZE | | 0201 | 0402 | 0603 | 0805 | 1206 | 1210 | 1812 | 2220 |
|---------|---|-----------|-----------|---------|---------|---------|---------|---------|---------|
| 尺寸 | L | 0.6 | 1.0 | 1.6 | 2.00 | 3.2 | 4.5 | 5.7 | 3.2 |
| | W | 0.3 | 0.5 | 0.8 | 1.25 | 1.6 | 3.2 | 5.0 | 2.5 |
| A | | 0.20~0.25 | 0.35~0.45 | 0.6~0.8 | 0.8~1.2 | 1.8~2.5 | 1.8~2.5 | 2.5~3.4 | 4.0~4.6 |
| B | | 0.20~0.30 | 0.40~0.50 | 0.6~0.8 | 0.8~1.2 | 1.0~1.5 | 1.0~1.5 | 1.8~2.0 | 2.0~2.2 |
| C | | 0.25~0.35 | 0.45~0.55 | 0.6~0.8 | 0.9~1.6 | 1.2~2.0 | 1.6~3.2 | 2.3~3.5 | 3.5~4.8 |

过量的焊锡会影响产品抵抗机械应力的能力，因此在设计图案时应引起注意。

Excess solder can affect the ability of chips to withstand mechanical stresses. Therefore, please take proper precautions when designing land-patterns.

在应用中一些焊接好与坏的情况：

Examples of good and bad solder application



| | |
|-------------------------------------|-------------------------------------|
| 产品标准书 SPECIFICATION FOR APPROVAL | 编号 Document No. DRAAW108K/1-2022 |
|-------------------------------------|-------------------------------------|

| 项目 Item | 不推荐结构 Not recommended | 推荐结构 Recommended |
|--|-----------------------|------------------|
| 片状元件和带引线的元件的混合焊接 Mixed mounting of SMD and leaded component | | |
| 靠近底座的焊接 Component placement close to the chassis | | |
| 在片状元件附近带引线元件的焊接 Hand-soldering of leaded components near mounted components | | |

8.1.2 图案结构 Pattern configurations

下面是电容器安装好与坏的样子。选择贴装位置，应尽可能减小电路板在弯曲时受到的机械应力。

The following are examples of good and bad capacitor layout, SMD capacitors should be located to minimize any possible mechanical stresses from board warp or deflection.

| | 不推荐结构 Not recommended | 推荐结构 Recommended |
|----------------------------------|-----------------------|------------------|
| 电路板弯曲 Deflection of the board | | |

对于电路板分拨的电容器，在分拨时受到的机械应力大小与电容器的安装有关。下面推荐了一些好的设计。

To layout the capacitors for the breakaway PC board, it should be noted that the amount of mechanical stresses given depending on capacitor layout. The example below shows recommendations for better design.



| | |
|-------------------------------------|-------------------------------------|
| 产品标准书 SPECIFICATION FOR APPROVAL | 编号 Document No. DRAAW108K/1-2022 |
|-------------------------------------|-------------------------------------|

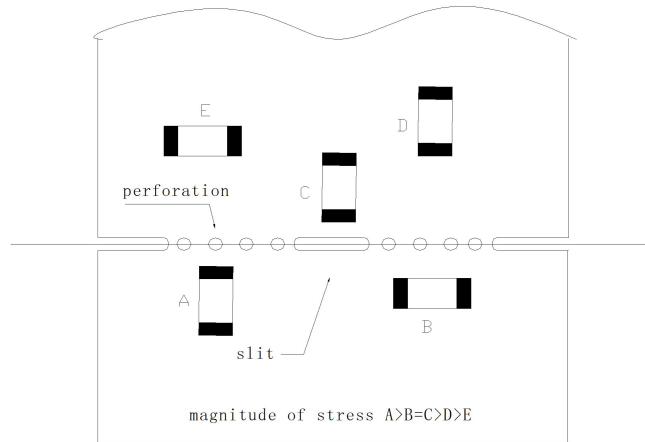

在沿着分拨线分拨电路板时，对产品施加的机械应力与使用的方法关系很大。分折电路板时片状元件受到的疲劳按照如下顺序增大：分折、剪切、V型槽、穿孔。因此，贴装时应该考虑电路板的分拨过程。

When breaking PC boards along their perforations, the amount of mechanical stress on the capacitors can vary according to the method used. The following methods are listed in order from least stressful to most stressful: push-back, slit, grooving, and perforation. Thus, any ideal SMD capacitor layout must also consider the PCB splitting procedure.

8.2 自动贴装注意事项 Considerations for automatic placement

贴装机的调整 Adjustment of mounting machine

- ① 产品在电路板贴装时，不应该受到过大的冲击。
- ② 必须定期对吸头和定位爪进行检查、维修和更换
- ① Excessive impact load should not be imposed on the capacitors when mounting the PC boards.
- ② The maintenance and inspection of the mounters should be conducted periodically.

| | 不推荐结构 Not recommended | 推荐结构 Recommended |
|-------------------------------|-----------------------|------------------|
| 单面贴装 Single-sided mounting | crack | supporting pin |
| 双面贴装 Double-sided mounting | solder peeling crack | supporting pin |



| | |
|-------------------------------------|-------------------------------------|
| 产品标准书 SPECIFICATION FOR APPROVAL | 编号 Document No. DRAAW108K/1-2022 |
|-------------------------------------|-------------------------------------|

8.3 推荐焊接曲线 Recommended soldering profile

8.3.1 说明：① 产品推荐使用回流焊接工艺；② 大尺寸产品适用于回流焊接工艺

Re: ① flow Soldering is recommended; ② flow soldering is suitable for bigger size MLCCs

8.3.2 锡铅焊接曲线 Recommended Sn&Pb soldering profile

回流焊 Reflow soldering

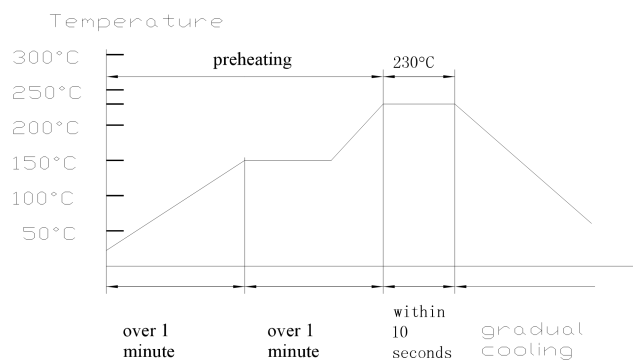

注意 Caution

- ① 理想状况的焊锡高度为电容器厚度的 1/3 ~1/2，如下图所示：
- ① The ideal condition is to have solder mass (fillet) controlled to 1/2 to 1/3 of the thickness of the capacitor, as shown below:

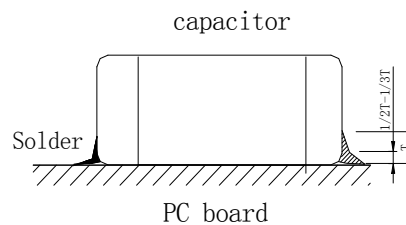

- ② 过长的焊接时间会影响端头的可焊性，焊接时间尽可能保持与推荐时间一致。
- ② Because excessive dwell times can detrimentally affect solderability, soldering duration should be kept as close to recommended times as possible.

波峰焊

Wave solder profile

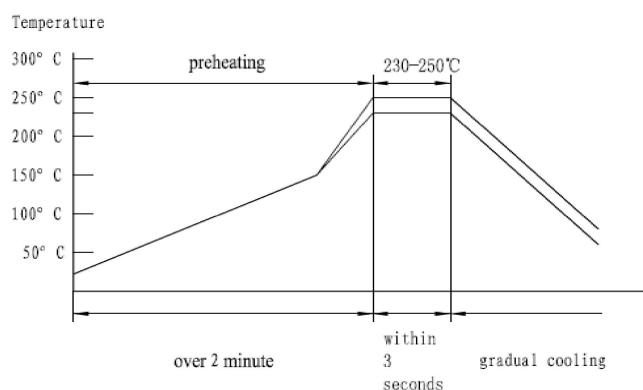



| | |
|----------------------------|------------------|
| 产品标准书 | 编号 Document No. |
| SPECIFICATION FOR APPROVAL | DRAAW108K/1-2022 |

注意 Caution

- ① 确保电容器充分预热。
- ② 产品预热和焊接温度差不超过 150℃。
- ③ 焊接后尽可能慢速冷却。
- ① Make sure the capacitors are preheated sufficiently.
- ② The temperature difference between the capacitor and melted solder should not be greater than 100 to 130℃.
- ③ Cooling after soldering should be gradual as possible.

手工焊接 Hand soldering

条件:

| 预热 | 烙铁头温度 | 烙铁功率 | 烙铁头直径 | 焊接时间 | 锡膏量 | 限制条件 |
|-----------------------------------|--------|-------|-------|------|-----------------|-----------------|
| $\Delta \leq 130^{\circ}\text{C}$ | 最高350℃ | 最大20W | 建议1mm | 最长5s | $\leq 1/2$ 芯片厚度 | 请勿使用烙铁头直接接触陶瓷原件 |

注意 Caution

- ① 用尖端最大直径 1.0mm 功率 20W 的焊接烙铁。
- ② 焊接烙铁不要直接接触产品。
- ① Use a 20w soldering iron with a maximum tip diameter of 1.0mm.
- ② The soldering iron should not directly touch the capacitor.

8.3.3 无铅焊接曲线 Recommended Pb-Free soldering profile

**回流焊接
Reflow solder**





| | |
|----------------------------|------------------|
| 产品标准书 | 编号 Document No. |
| SPECIFICATION FOR APPROVAL | DRAAW108K/1-2022 |

波峰焊接

Wave solder profile



8.4 分拨电路板 Handling

Breakaway PC boards (splitting along perforations)

- (1) 在电容器或其它贴装后，必须注意因电路板弯曲或变形带来的应力。
- (2) 分拨电路板时必须使用专用的夹具，不可以用手拨断。

- (1) When splitting the PC board after mounting capacitors and other components, care is required so as not to give any stresses of deflection or twisting to the board.
- (2) Board separation should not be done manually, but by using the appropriate devices.

8.5 保存 Storage

- (1) 在下列环境中保存产品：温度 5~40°C；湿度 ≤70% RH
- (2) 产品自生产之日保存期为一年，产品使用之前请勿拆开编带。
- (3) 编带拆开后，产品应在三个月内使用。
- (4) 高介电常数电容器 (X7R/X7S/X7T/X5R/X6R/X6S/X6T) 的容值随时间会逐渐减小，所以在电路设计时应充分考虑这一现象。容值减小的电容器在 150°C 热处理 1 小时后容值会恢复到初始值。

- (1) Keep the storage environment conditions as following: Temperature: 5~40°C； Humidity: ≤70% RH
- (2) Don't open the tape until the parts are to be used, and store them within one year since the date printed on the reel.
- (3) Use the chips within 3 months after the tape is opened.
- (4) The capacitance value of high dielectric constant capacitors (X7R/X7S/X7T/X5R/X6R/X6S/X6T) will gradually decrease with the passage of time, so this should be taken into consideration in the circuit design. If such a capacitance reduction occurs, a heat treatment of 150°C for 1 hour will return the capacitance to its initial level.



CCTC
三环集团

潮州三环（集团）股份有限公司
Chaozhou Three-Circle (Group) Co., Ltd.

地址：广东省潮州市凤塘三环工业城

邮编(Post Code)：515646

ADD：San Huan Industrial District ,Feng Tang Chao Zhou, GuangDong, China

相关特性曲线图 Curve diagram of related features

(例)(example) **TCC0603X7R104K500CT**

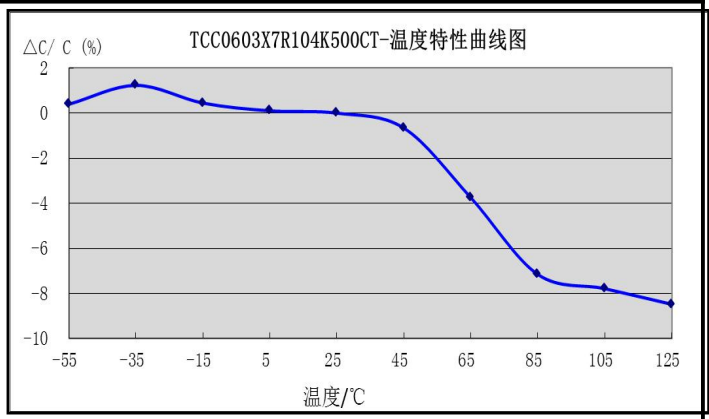
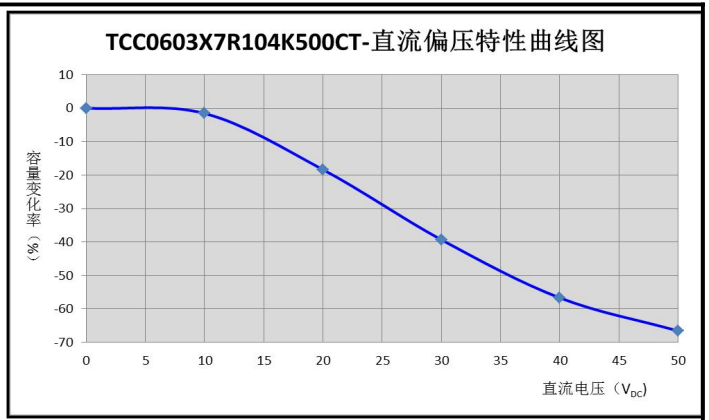

X-ON Electronics

Largest Supplier of Electrical and Electronic Components

Click to view similar products for [Multilayer Ceramic Capacitors MLCC - SMD/SMT](#) category:

Click to view products by [CCTC](#) manufacturer:

Other Similar products are found below :

[M39014/02-1218V](#) [M39014/02-1225V](#) [M39014/22-0631](#) [D55342E07B523DR-T/R](#) [NIN-FB391JTRF](#) [NIN-FC2R7JTRF](#)
[NMC0402NPO220J50TRPF](#) [NMC0402X5R105K6.3TRPF](#) [NMC0402X5R224K6.3TRPF](#) [NMC0402X7R103J25TRPF](#)
[NMC0402X7R392K50TRPF](#) [NMC0603NPO201J50TRPF](#) [NMC0603NPO330G50TRPF](#) [NMC0603NPO331F50TRPF](#)
[NMC0603X5R475M6.3TRPF](#) [NMC0603X7R333K16TRPF](#) [NMC0805NPO220J100TRPF](#) [NMC0805NPO820J50TRPF](#)
[NMC1206X7R102K50TRPF](#) [NMC1206X7R106K10TRPLPF](#) [NMC-H0805X7R472K250TRPF](#) [C1608C0G2A221J](#) [C1608X7R1E334K](#)
[C2012C0G2A472J](#) [2220J2K00562KXT](#) [CCR06CG153FSV](#) [CDR33BX104AKUR](#) [CDR33BX683AKUS](#) [CGA3E1X7R1C684K](#)
[CL10C0R8BB8ANNC](#) [M55342H06B20G0R-T/R](#) [C1005X5R0G225M](#) [C2012X7R2E223K](#) [C3216C0G2J272J](#) [D55342E07B35E7R-T/R](#)
[CDR34BX563BKUS](#) [CDR34BX563BKWS](#) [NMC0402NPO220F50TRPF](#) [NMC0402X7R562J25TRPF](#) [NMC0603NPO102J25TRPF](#)
[NMC1206X7R332K50TRPF](#) [NMC-P1206X7R104K250TRPLPF](#) [726632-1](#) [CGA6M3X7R1H225K](#) [CGA5L2X7R2A105K](#)
[CGA3E2X8R1H223K](#) [CDR33BX823AKUR\M500](#) [CDR33BP132BJUR](#) [CDR35BX474AKUR\M500](#) [CDR35BX104BKUR\M500](#)