

## 承认书

### SPECIFICATION FOR APPROVAL

客户名称: CUSTOMER:	灿容
产品名称: PARTNAME:	多层片式瓷介电容器 Multilayer Chip Ceramic Capacitor
产品规格: SPECIFICATION:	TCC0603X7R332K500CTS TCC0603X7R332K500CTS
承认书编号: APPROVAL SHEET NO.:	DRAAW108G/1-2023 DRAAW108G/1-2023
发出日期 ISSUED DATE:	2023/5/31 2023/5/31

制造		
MANUFACTURER		
批准	审核	经办
APPROVED	CHECKED	PREPARED
梁俊	王彬彬	陈家锐

客户		
CUSTOMER		
批准	审核	经办
APPROVED	CHECKED	PREPARED

**潮州三环（集团）股份有限公司**

地址 1：中国广东省潮州市凤塘三环工业城(潮州总部)  
 地址 2：四川省南充市高坪区清溪街道南充三环集团三厂区（南充基地）  
 地址 3：广东省深圳市光明区光源五路汇业科技园（深圳基地）  
 总部电话：86-768-6855932  
 总部传真：86-768-6855921  
 网址：HTTP://WWW.CCTC.CC

电话(Tel): 86-768-6855949, 658923  
 E-mail:gyc@cctc.cc

传真(Fax): (768)6855928, 6855921  
 Website:Http://www.cctc.cc



文件编号	DRAAW108G/1-2023		页数	23
文件名称	多层片式陶瓷电容器(产品承认书)		制订日期	2012.01
版数	制定、修订日期	页数	制定、修订内容	登记者
B/0	2012/1/11	38	新制定	方千军
B/1	2012/8/11	36	增加2225、1808尺寸的载带尺寸	王彬彬
C/0	2013/1/10	39	换版	王彬彬
C/1	2013/6/5	29	新制定	王彬彬
D/0	2014/5/6	25	换版	张国信
E/0	2016/5/19	25	换版	张国信
F/0	2017/7/1	25	换版	张国信
G/0	2020/2/12	25	换版	张国信
G/1	2022/11/28	23	增加RoHS、REACH和无卤要求	陈家锐

## 目录

1. 电容器及介质分类.....	4
2. 产品结构.....	4
3. 产品规格型号命名规则.....	5
4. 产品尺寸.....	5
5. 技术要求和测试条件.....	6
6. 产品包装.....	15
7. MLCC使用注意事项.....	18

## 1. 电容器及介质分类 Types of Capacitor and Dielectric Material

※X7R：此类介质材料的电容器为Ⅱ类电容器，具有较高的介电常数，容量比Ⅰ类电容器高，具有较稳定的温度特性，适用于容量范围广，稳定性要求不高的电路中，如隔直、耦合、旁路、鉴频等电路中。

※ X7R: material is a kind of material has high dielectric constant. The capacitor made of this kind material is considered as Class II capacitor whose capacitance is higher than that of class I. These capacitors are classified as having a semi-stable temperature characteristic and used over a wide temperature range, such in these kinds of circuits, DC-blocking, decoupling, bypassing, frequency discriminating etc.

## 2. 产品结构 Product Frame

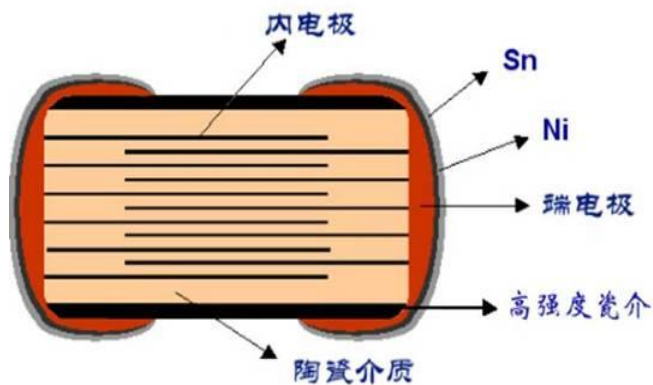

### 3. 产品规格型号命名规则

#### General Product Parts Numbering System

(例) (example)

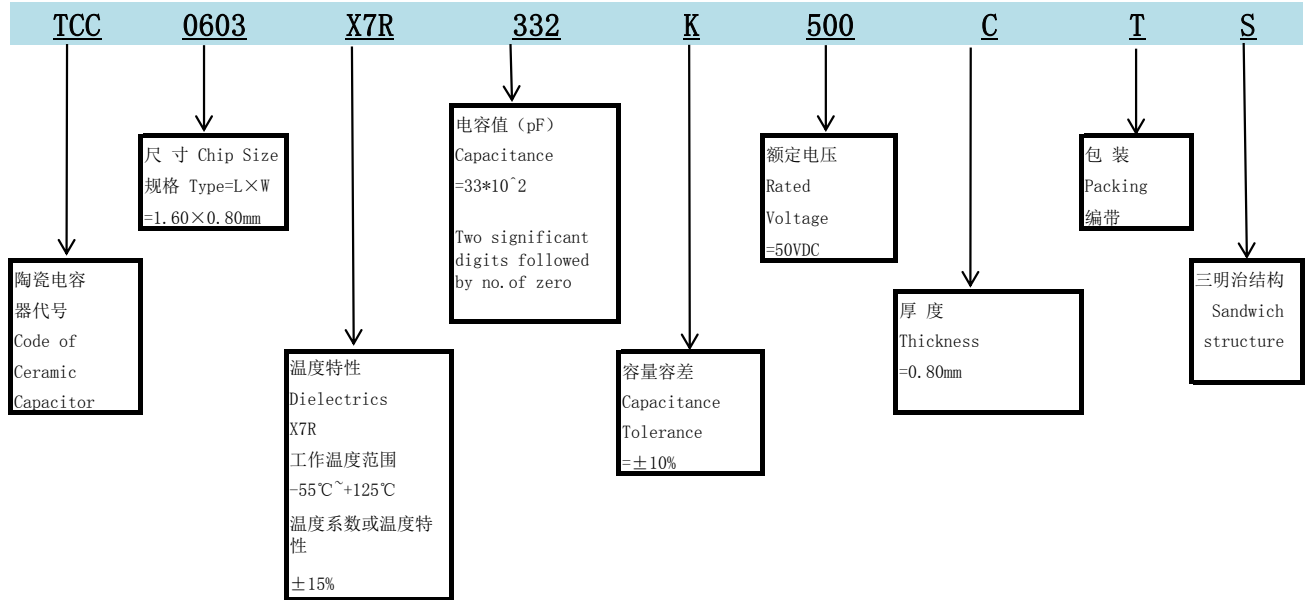

### 4. 产品尺寸 Dimensions

规格：0603  
Chip Size：0603

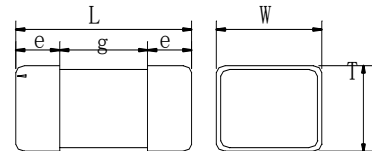

规格	L	W	e	g min	T
Type	(mm)	(mm)	(mm)	(mm)	(mm)
0603	1.60±0.10	0.80±0.10	0.2~0.6	0.50	0.80±0.10

电话(Tel)：86-768-6855949, 658923

E-mail:gyc@cctc.cc

传真(Fax)：(768)6855928, 6855921

Website:Http://www.cctc.cc

## 5. 技术要求和测试条件 Specification and Test Condition

### 5.1 外观 Appearance

类型 Dielectrics	技术要求 Specification	测试条件 Testing
X7R	$l \leq 1/8L, w \leq 1/8W, t \leq 1/8T$	目视检查 Visual inspection.

### 5.2 尺寸 Dimensions

类型 Dielectrics	技术要求 Specification	测试条件 Testing Condition
X7R	在要求的范围内 Within the specified dimensions	用千分尺 Using calipers on micrometer

### 5.3 容量 Capacitance

类型 Dielectrics	技术要求 Specification	测试条件 Testing Condition
X7R	在要求的容值容差范围内 Within the specified tolerance 2. $97 \sim 3.63nF$	$1.0 \pm 0.2V_{rms}, 1KHz \pm 10\%$ ;
备注：测试温度： $25^{\circ}C \pm 3^{\circ}C$ ，测试湿度：<70%RH. 针对二类介质规格需去老化处理， 条件：电容器在 $150^{\circ}C$ 热处理1小时，放置48h后进行测量。		

### 5.4 损耗 Dissipation Factor

类型 Dielectrics	技术要求 Specification	测试条件 Testing Condition
X7R	$DF \leq 5.0\%$	$1.0 \pm 0.2V_{rms}, 1KHz \pm 10\%$ ;
备注：测试温度： $25^{\circ}C \pm 3^{\circ}C$ ，测试湿度：<70%RH. 针对二类介质规格需去老化处理， 条件：电容器在 $150^{\circ}C$ 热处理1小时，放置48h后进行测量。		

5.5 绝缘电阻 Insulation Resistance

类型 Dielectrics	技术要求 Specification	测试条件 Testing Condition
X7R	$\geq 10G\Omega$	测试电压：50V； 充电时间：60±5秒； 温度：25℃； test voltage:50V； Charge Time:60±5sec； Temperture:25℃
备注：测试温度：25℃±3℃，测试湿度：<70%RH.		

5.6耐电压 Dielectric Strength

类型 Dielectrics	额定电压范围 Rated voltage range	耐电压性能测试方法 Measuring Method
X7R	UR=50V	施加电压125V, 5秒, 最大电流不超过50mA； Force 125V for 5second. Max. current should not exceed 50 mA.
备注：测试温度：25℃±3℃，测试湿度：<70%RH.		

5.7 静电容量温度特性 Temperature Coefficient of Capacitance

类型 Dielectrics	技术要求 Specification	测试条件 Testing Condition	
X7R	容量变化在±15%以内 Capacitance change within ±15%	按系列温度顺序测试电容容量	
		Measure capacitance under follow table list temperature(℃):	
		在140~150℃预处理1小时，放置24小时后进行测量，测试电压1Vrms。	
		步骤 STEP	X7R
		1	25±2
		2	-55±3
		3	25±2
4	125±3		
5	25±2		
		X7R 与25℃时的电容容量相比较，电容容量在温度范围内的变化在要求的范围之内。 The ranges of capacitance change compared within the above 25℃ value over the temperature ranges shall be within the specified ranges.	
备注1：测试温度：25℃±3℃，测试湿度：<70%RH.			
备注2：0201/223及以上、0402/104及以上规格、0603/334及以上规格、0805/105及以上规格、1206/1210 225及以上规格，测试电压：0.1Vrms			

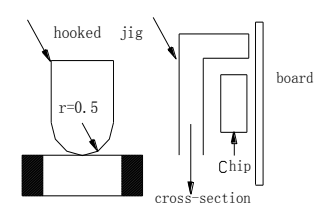

5.8 附着力 Adhesion

类型 Dielectrics	技术要求 Specification	测试条件 Testing Condition
X7R	端电极无松动，也无其它不良现象No removal of the terminations or other defect shall occur.	施加6N的压力，并保持10±1秒 The pressurizing force shall be 6N and the duration of application shall be 10±1sec. 

5.9可焊性 Solderability of Termination

类型 Dielectrics	技术要求 Specification	测试条件 Testing Condition
X7R	端电极挂锡面积不小于95%，针孔或粗糙面积小于5%。 95% min-coverage of both terminal electrodes and less than 5% have pin holes or rough spots.	锡炉温度：245±5℃ 浸入时间：2±1秒 两侧端电极完全浸入焊锡炉 Solder temperature: 245±5℃ Dipping time: 2±1 seconds. Completely soak both terminal electrodes in solder.

5.10 耐焊性 Resistance to leaching

类型 Dielectrics	技术要求 Specification	测试条件 Testing Condition
X7R	端电极挂锡面积不小于95%，针孔或粗糙面积小于5%，外观无开裂。 95% min. coverage of both terminal electrodes and less than 5% have pin holes or rough spots.No remarkable visual damage.	预热：120℃~150℃/60秒 锡炉温度：270±5℃ 浸入时间：10±1秒 两侧端电极完全浸入焊锡炉 Solder temperature: 270±5℃ preheated: 120℃~150℃/60sec Dipping time: 10±1 seconds. Completely soak both terminal electrodes in solder.

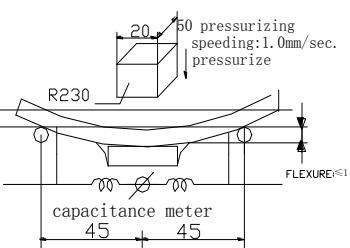

5.11 端电极结合强度 Bending

类型 Dielectrics	技术要求 Specification	测试条件 Testing Condition
X7R	无可见损伤；容量变化小于等于±10% No remarkable visual damage; Cp change ≤ ± 10%.	<p>将片状电容器安装在测试夹具上，按图所示方向以1.0mm/s的速率施加压力，弯曲2mm。</p> <p>Solder the capacitor on testing substrate and put it on testing stand. The middle part of substrate shall successively be pressurized by pressuring rod at a rate of about 1.0mm/sec. Until the deflection become means of the 2mm.</p> 

5.12 耐焊接热 Resistance to Soldering Heat

类型 Dielectrics	技术要求 Specification	测试条件 Testing Condition
X7R	<p>无明显可见损伤,容量变化在±7.5%以内,DF满足产品初始值的要求,IR满足产品初始值的要求</p> <p>No remarkable visual damage,Cp change within ±7.5%.DF and IR meets initial standard value.</p>	<p>焊接温度: 270±5℃            预热: 120~150℃ 60秒            浸入时间: 10±1秒            在室温下放置 48±4 小时以后测量            试验后在标准条件下恢复</p> <p>*高介电常数电容器的初始值测量            在140~150℃进行1小时的热处理后在室温下放置48±4小时            测量初始值</p> <p>Soldering temperature: 270±5℃            Preheating: 120~150℃ 60sec.            Dipping time: 10±1 seconds.</p> <p>Measurement to be made after being kept at room temperature for 48±4hours.Recovery for the following period under the standard condition after test.</p> <p>*Initial measurement for high dielectric constant typePerform a heat treatment at 140~150℃ for 1hr and let sit for 48±4hrs at room temperature.Perform the initial measurement.</p>

5.13 温度快速循环 Temperature Cycle

类型 Dielectrics	技术要求 Specification	测试条件 Testing Condition															
X7R	<p>无明显可见损伤，容量变化在±7.5%以内。</p> <p>No remarkable visual damage.Cp change within ±7.5%.</p>	<p>按下列步骤进行5次循环： To perform 5 cycles of the stated environment</p> <table border="1"> <thead> <tr> <th>步骤Step</th> <th>温度</th> <th>时间</th> </tr> </thead> <tbody> <tr> <td>1</td> <td>下限类别温度+0/-3℃ Min. operating Temp. +0/-3℃</td> <td>30min</td> </tr> <tr> <td>2</td> <td>25℃</td> <td>2~3 min</td> </tr> <tr> <td>3</td> <td>上限类别温度+3/-0℃ Max. operating Temp. +3/-0℃</td> <td>30 min</td> </tr> <tr> <td>4</td> <td>25℃</td> <td>2~3 min</td> </tr> </tbody> </table> <p>在室温下放置48±4小时以后测量。</p> <p>*高介电常数电容器的初始值测量。 在140~150℃进行1小时的热处理后在室温下放置48±4小时测量初始值。</p> <p>Measurement to be made after being kept at room temperature for 48±4hrs at room temperature, then measure.</p> <p>*Initial measurement for high dielectric constant type.Perform a heat treatment at 140~150℃ for 1hr and let sit for 48±4hrs at room temperature.Perform the initial measurement.</p>	步骤Step	温度	时间	1	下限类别温度+0/-3℃ Min. operating Temp. +0/-3℃	30min	2	25℃	2~3 min	3	上限类别温度+3/-0℃ Max. operating Temp. +3/-0℃	30 min	4	25℃	2~3 min
步骤Step	温度	时间															
1	下限类别温度+0/-3℃ Min. operating Temp. +0/-3℃	30min															
2	25℃	2~3 min															
3	上限类别温度+3/-0℃ Max. operating Temp. +3/-0℃	30 min															
4	25℃	2~3 min															

5.14 稳态湿热 Moisture Resistance ,steady state

类型 Dielectrics	技术要求 Specification	测试条件 Testing Condition
X7R	外观无明显可见损伤，容量变化在±12.5%以内，DF为初始值的2倍以下，IR:大于等于1000MΩ Cp change within ±12.5%.DF:Not more than 2 times of initial value, IR≥1000MΩ	测试温度：40±2℃ 湿度：90~95% RH 测试时间：500 ±12hrs 在室温下放置48±4小时以后测量  *高介电常数电容器的初始值测量在140~150℃进行1小时的热处理后在室温下放置48±4小时测量初始值。  Test temperature: 40±2℃ Humidity: 90~95% RH Testing time: 500 ±12hrs Measurement to be made after being kept at room temperature for 48±4hrs.  *Initial measurement for high dielectric constant type.Perform a heat treatment at 140~150℃ for 1hr and let sit for 48±4hrs at room temperature.Perform the initial measurement.

5.15 耐湿负荷 Damp heat with load

类型 Dielectrics	技术要求 Specification	测试条件 Testing Condition
X7R	<p>外观无明显可见损伤,容量变化在±12.5%以内,DF为初始值的2倍以下。 IR: 大于等于500MΩ No remarkable visual damage, Cp change ≤ ± 12.5%. DF: Not more than 2 times of initial value. IR ≥ 500MΩ</p>	<p>测试温度: 40±2℃ 湿度: 90~95% RH 电压: 额定电压 测试时间: 500 ±12hrs 初始测量需在焊接后, 在室温下放置48±4小时以后测量。 *高介电常数电容器的测量 在实验结束后, 需在150℃温度下, 保持1h后, 再放置48h后再测试电性能</p> <p>Test temperature: 40±2℃ Humidity: 90~95% RH Voltage: 100% of the rated Testing time: 500 ±12hrs After soldering, Measurement to be made after being kept at room temperature for 48±4hrs. *Measurement for high dielectric constant type. After experiment, product need to keep in 150℃、1h, and measurement to be made after being kept at room temperature for 48h.</p>
备注：该项可靠性试验仅适用于常规产品，不适用于中高压产品。		

5.16 耐久性 Life Test

类型 Dielectrics	技术要求 Specification	测试条件 Testing Condition
X7R	外观无明显可见损伤, 容量变化在±12.5%以内, DF为初始值的2倍以下。IR:大于等于1000MΩ No remarkable visual damage. Cp change ≤ ±12.5%. DF: Not more than 2 times of initial value. IR ≥ 1000MΩ	测试温度: 上限类别温度±3℃ 1.5倍额定电压 (*见备注)  测试时间: 1000 小时 初始测量需在焊接后, 在室温下放置48±4小时以后测量。 *高介电常数电容器的测量  在实验结束后, 需在150℃温度下, 保持1h后, 再放置48h后再测试电性能  Test temperature: Max. Operating Temp. ±3℃ Voltage: 150% of the rated voltage (*Remarks) Testing time: 1000 hrs  After soldering, Measurement to be made after being kept at room temperature for 48±4hrs.  *Measurement for high dielectric constant type.  After experiment, product need to keep in 150℃、1h, and Measurement to be made after being kept at room temperature
备注*1: Ur ≥ 100V都按照1倍额定电压。 备注*2: 0201/104及以上规格、0402/104的25V及以上电压及容量、0603/105的25V及以上电压及容量、0805/225的25V及以上电压及容量、1206/475的25V及以上电压及容量、1210/225的25V及以上电压及容量, 按照1倍额定电压测试。		



## 6. 产品包装 Packing

### 6.1 袋式散装 Bulk Packing

10000个/袋或按客户要求。Standard packing 10Kpcs/bag; others are according to customer request.

### 6.2 编带式包装 Tape Packing

规格 Type	尺寸 Size (mm)			编带数量(个/盘 pcs/reel)	
	长度L	宽度W	厚度T	纸带Paper Tape	塑料带Plastic Tape
0603	1.60	0.80	0.80	4000	N/A
	-	-	-	-	-

#### 6.2.1 纸带尺寸 Dimensions of Packing Paper

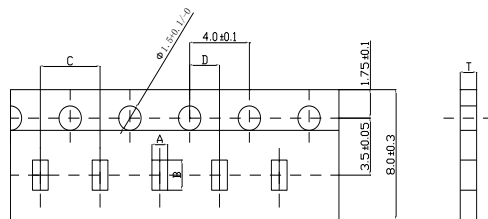

Type	A	B	C	D	T
0201	0.36±0.03	0.67±0.03	2.00±0.10	2.00±0.05	0.42max
0402	0.65±0.10	1.15±0.10	2.00±0.05	2.00±0.05	0.8max
0603	1.05±0.10	1.85±0.10	4.00±0.10	2.00±0.10	1.1max
0805	1.55±0.15	2.30±0.15	4.00±0.10	2.00±0.10	1.1max
1206	1.95±0.15	3.50±0.15	4.00±0.10	2.00±0.10	1.1max

(单位unit:毫米mm)

#### 6.2.2 塑料带尺寸 Dimensions of Embossed Packing

8mm宽, 4mm间距编带

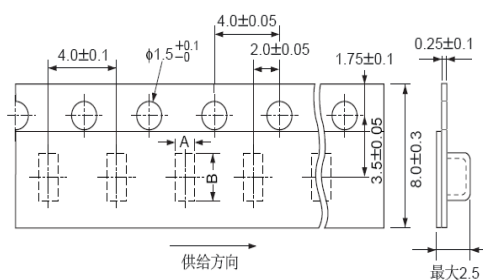

12mm宽, 8mm/4mm间距编带

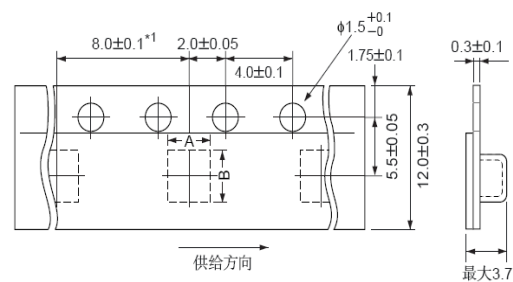

A: 1.45±0.20 B: 2.25±0.20 (0805) A: 1.95±0.20 B: 3.50±0.20 (1206)

A: 2.90±0.20 B: 3.60±0.20 (1210)

(单位unit:毫米mm)

电话(Tel): 86-768-6855949, 658923

传真(Fax): (768)6855928, 6855921

E-mail:gyc@cctc.cc

Website:Http://www.cctc.cc

### 6.2.3 编带盘尺寸 Dimensions of Reel

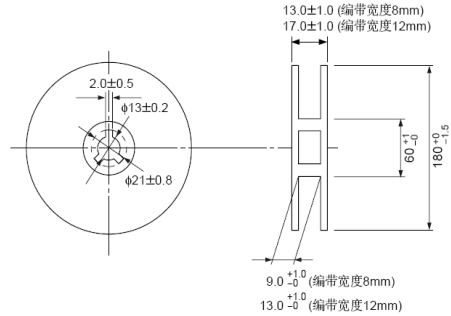

### 6.2.4 编带方式 Taping Figure

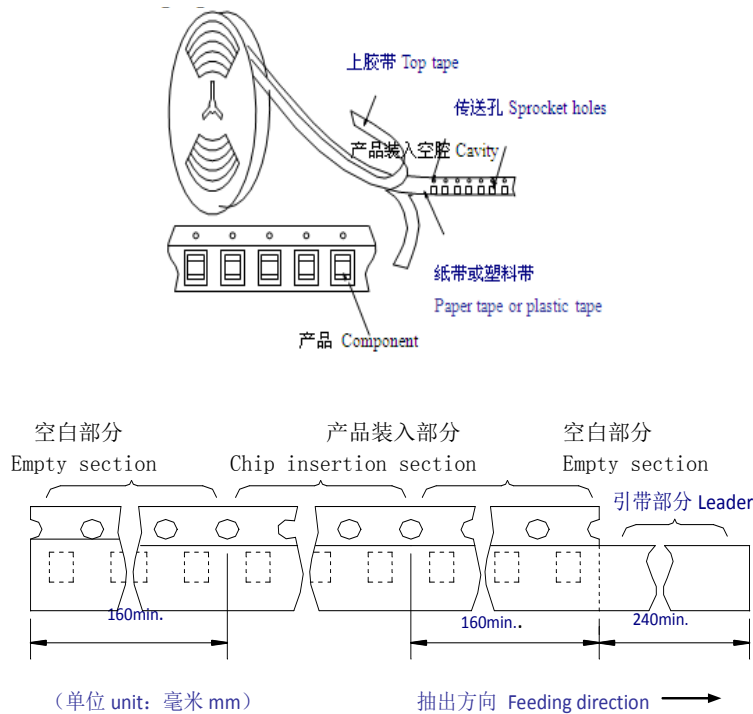

### 6.2.5 编带方法 Taping Method

- ① 包装电容器的编带是顺时针卷绕的，由上往下的方向拉出编带时，传送孔处于编带的右侧。
- ② 在编带的前端，至少留出5个间距的引出带。
- ③ 在编带时，必须按下图留出引带部分或空白部分。
- ④ 在盘带的安装中的产品装错的数量每盘必须小于表示数量的0.1%或1个为限，不连续发生错误。
- ⑤ 上胶带和下胶带不应超出编带的边缘，不能挡住传送孔。
- ⑥ 传送孔的累计误差为10个间距： $\pm 0.3$ 毫米以内。
- ⑦ 上胶带的剥离力矩应在0.1至0.6牛顿以内，其方向如下图所示。

- ① Tapes for capacitors are wound clockwise. The sprocket holes are to the right as the tape is pulled toward the user.
- ② The top tape and base tape are not attached at the end of the tape for a minimum of 5 pitches.
- ③ Part of the leader and part of the empty tape shall be attached to the end of the tape as follows.
- ④ Missing capacitors number within 0.1% of the number per reel or lpc, whichever is greater, and are not continuous.
- ⑤ The top tape and bottom tape shall not protrude beyond the edges of the tape and shall not cover sprocket holes.
- ⑥ Cumulative tolerance of sprocket holes, 10 pitches:  $\pm 0.3\text{mm}$ .
- ⑦ Peeling off force: 0.1 to 0.6N in the direction shown down.

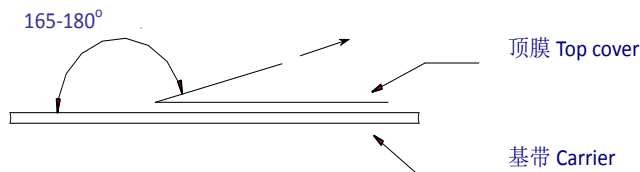

#### 6.2.6 产品标签 Reel Label

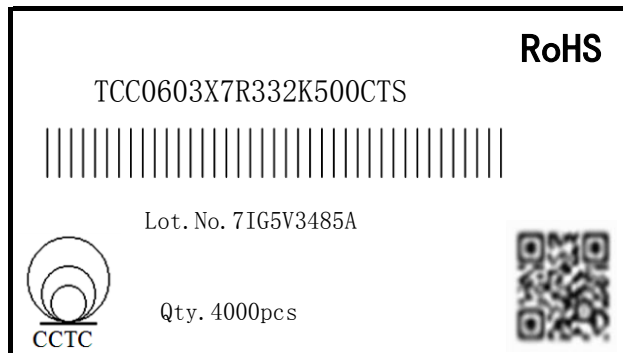

标签内容 The Contents of Label

- (1)
- |            |             |            |            |          |            |          |          |          |
|------------|-------------|------------|------------|----------|------------|----------|----------|----------|
| <u>TCC</u> | <u>0603</u> | <u>X7R</u> | <u>332</u> | <u>K</u> | <u>500</u> | <u>C</u> | <u>T</u> | <u>S</u> |
| ①          | ②           | ③          | ④          | ⑤        | ⑥          | ⑦        | ⑧        | ⑨        |

①陶瓷电容器代号Code of Ceramic Capacitor

②尺寸chip size, ③温度特性dielectrics, ④容量capacitance, ⑤容量容差tolerance,

⑥额定电压rated voltage, ⑦厚度thickness, ⑧包装packing, ⑨三明治Sandwich structure;

(2) 产品批号Lot. No.: 7IG5V3485A

(3) 数量Qty: 4000pcs

(4) RoHS: GREEN PARTS 绿色物料

电话(Tel): 86-768-6855949, 658923

E-mail:gyc@cctc.cc

传真(Fax): (768) 6855928, 6855921

Website:Http://www.cctc.cc

## 6.2.7. 外包装 Package

### 6.2.7.1 包装箱Carton

#### 6.2.7.1.1 包装箱尺寸Carton Size

L	W	H
41.0cm	38.5cm	20.2cm

#### 6.2.7.1.2 数量:

240Kpcs /箱

The Quantity:240Kpcs /one carton

1 内包装盒=40000PCS

1 INNER BOX=40000PCS

1 包装箱 =40000PCS × 10包装盒=240KPCS

1 CARTON=40000PCS × 10BOX=240KPCS

RoHS标识(根据客户要求张贴) according to customer request

### 6.2.7.2 内包装盒 Inner Box

#### 6.2.7.2.1 包装盒尺寸 Size

L	W	H
18.5cm	6.5cm	19cm

#### 6.2.7.2.2 数量: 40000pcs /盒

1盘=4000PCS

1 REEL=4000PCS

1包装盒=4000PCS × 10盘 =40000PCS

1 INNER BOX=4000PCS × 10REEL =40000PCS

## 7. MLCC使用注意事项 Precautions on the use of MLCC

### 7.1 电路板设计 PCB Design

#### 7.1.1 电路板图案设计 Design of Land-patterns

下面图和表格给出了部分推荐的设计图案，可以防止安装时焊锡量过多。

同时也给出了不正确的图案。

电路板设计推荐图案尺寸：

波峰焊接时推荐设计的尺寸（单位：mm）：

The following diagrams and tables show some examples recommended patterns to prevent excessive solder amounts (larger fillets which above the component end terminations).

Examples of improper pattern designs are also shown.

Recommended land dimensions for a typical chip capacitor land patterns for PCBs. Recommended land dimensions for wave-soldering. (unit: mm)

规格SIZE	0603	0805	1206	
尺寸	L	1.6	2	3.2
	W	0.8	1.25	1.6
A	0.8~1.0	1.0~1.4	1.8~2.5	
B	0.5~0.8	0.8~1.5	0.8~1.7	
C	0.6~0.8	0.9~1.2	1.2~1.6	

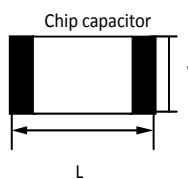
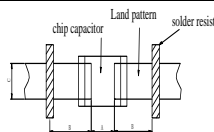

电话(Tel): 86-768-6855949, 658923

传真(Fax): (768)6855928, 6855921

E-mail:gyc@cctc.cc

Website:Http://www.cctc.cc

再流焊接时推荐设计的尺寸（单位：mm）

Recommended land dimensions for reflow-soldering (unit: mm)

规格SIZE		0603
尺寸 (mm)	L	1.6
	W	0.8
A		0.6~0.8
B		0.6~0.8
C		0.6~0.8

过量的焊锡会影响产品抵抗机械应力的能力，因此在设计图案时应引起注意。

Excess solder can affect the ability of chips to withstand mechanical stresses.

Therefore, please take proper precautions when designing land-patterns.

在应用中一些焊接好与坏的情况：

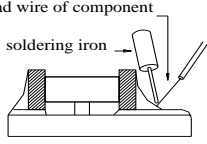
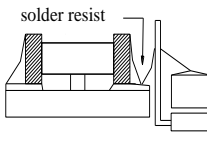
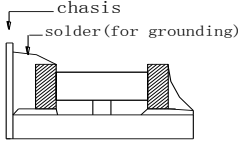
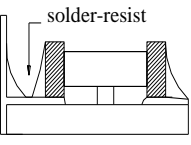
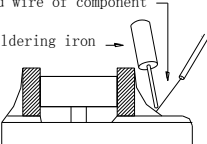
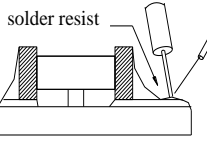

Examples of good and bad solder application.

项目Item	不推荐结构Not recommended	推荐结构Recommended
片状元件和带引线的元件的混合焊接 Mixed mounting of SMD and leaded component		
靠近底座的焊接 Component placement close to the chassis		
在片状元件附近带引线元件的焊接 Hand-soldering of leaded components near mounted		

### 7.1.2 图案结构 Pattern configurations

下面是电容器安装好与坏的例子。选择贴装位置，应尽可能减小电路板在弯曲时受到的机械应力。

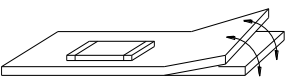
The following are examples of good and bad capacitor layout, SMD capacitors should be located to minimize any possible mechanical stresses from board warp or deflection..

项目Item	不推荐结构Not recommended	推荐结构Recommended
电路板弯曲 Deflection of the board		

对于电路板分拨的电容器，在分拨时受到的机械应力大小与电容器的安装有关。

下面推荐了一些好的设计。

To layout the capacitors for the breakaway PC board, it should be noted that the amount of mechanical stresses given depending on capacitor layout. The example below shows recommendations for better design.

电话(Tel): 86-768-6855949, 685923

传真(Fax): (768) 6855928, 6855921

E-mail:gyc@cctc.cc

Website:Http://www.cctc.cc

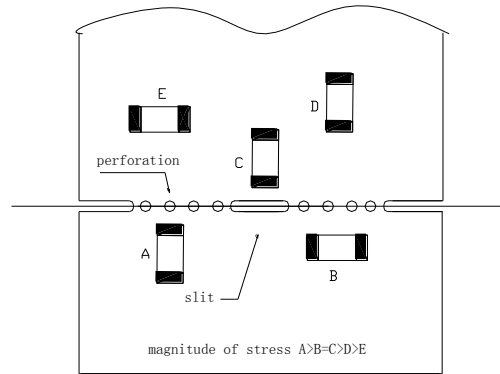

在沿着分拨线分拨电路板时，对产品施加的机械应力与使用的方法关系很大。分折电路板时片状元件受到的疲劳按照如下顺序增大：分折、剪切、V型槽、穿孔。因此，贴装时应该考虑电路板的分拨过程。

When breaking PC boards along their perforations, the amount of mechanical stress on the capacitors can vary according to the method used. The following methods are listed in order from least stressful to most stressful: push-back, silt, -grooving, and perforation. Thus, any ideal SMD capacitor layout must also consider the PCB splitting procedure.

## 7.2 自动贴装注意事项 Considerations for automatic placement

贴装机的调整 Adjustment of mounting machine

- ①. 产品在电路板贴装时，不应该受到过大的冲击。
- ②. 必须定期对吸头和定位爪进行检查、维修和更换。
- ①. Excessive impact load should not be imposed on the capacitors when mounting the PC boards.
- ②. The maintenance and inspection of the mounters should be conducted periodically.

项目Item	不推荐结构Not recommended	推荐结构Recommended
单面贴装 Single-sided mounting		
双面贴装 Double-sided mounting		

## 7.3 推荐焊接曲线 Recommended soldering profile

7.3.1 说明:

- ① 产品推荐使用回流焊接工艺;
- ② 大尺寸产品适用于回流焊接工艺。

Re:

- ①flow Soldering is recommended;
- ②flow soldering is suitable for bigger size MLCCs.



7.3.2 锡铅焊接曲线 Recommended Sn&Pb soldering profile

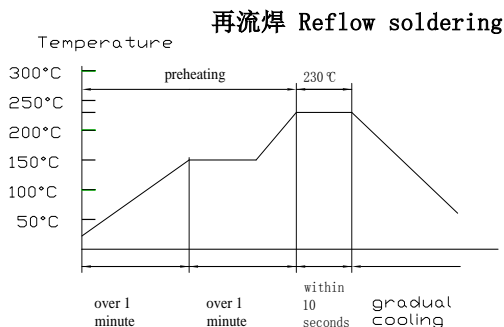

注意 Caution

①理想状况的焊锡高度为电容器厚度的 $1/3 \sim 1/2$ ，如下图所示：

①The ideal condition is to have solder mass (fillet) controlled to  $1/2$  to  $1/3$  of the thickness of the capacitor, as shown below:

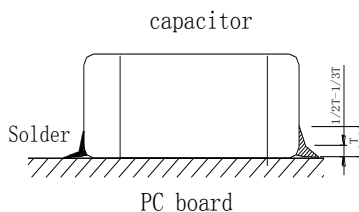

②过长的焊接时间会影响端头的可焊性，焊接时间尽可能保持与推荐时间一致。

②Because excessive dwell times can detrimentally affect solderability, soldering duration should be kept as close to recommended times as possible.

**波峰焊 Wave solder profile**

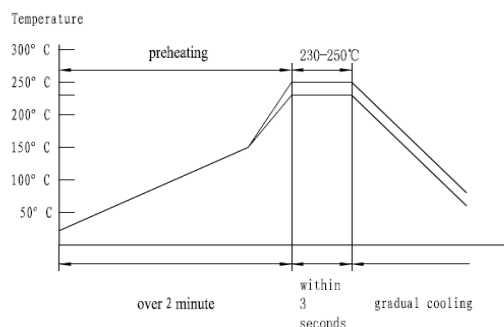

注意Caution

①. 确保电容器充分预热。

②. 产品预热和焊接温度差不超过 $100 \sim 130^\circ\text{C}$ 。

③. 焊接后尽可能慢速冷却。

①.Make sure the capacitors are preheated sufficiently.

②.The temperature difference between the capacitor and melted solder should not be greater than 100 to  $130^\circ\text{C}$ .

③.Cooling after soldering should be gradual as possible.

手工焊接 Hand soldering

条件:

预热	烙铁头温度	烙铁功率	烙铁头直径	焊接时间	锡膏量	限制条件
$\Delta \leq 130^{\circ}\text{C}$	最高 $350^{\circ}\text{C}$	最大20W	建议1mm	最长5s	$\leq 1/2$ 芯片厚度	请勿使用烙铁头直接接触陶瓷原件

注意 Caution

- ①. 用尖端最大直径1.0mm功率20W的焊接烙铁。
- ②. 焊接烙铁不要直接接触产品。
- ①. Use a 20w soldering iron with a maximum tip diameter of 1.0mm.
- ②. The soldering iron should not directly touch the capacitor.

7.3.3无铅焊接曲线 Recommended Pb-Free soldering profile

回流焊接 Reflow solder

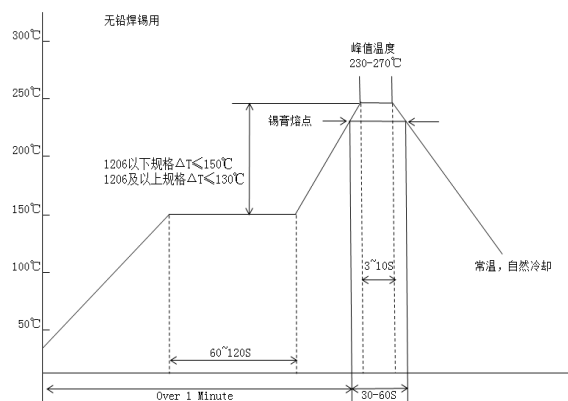

波峰焊接 Wave solder profile

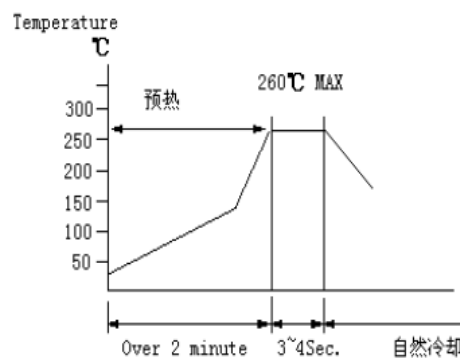

电话(Tel): 86-768-6855949, 658923

传真(Fax): (768)6855928, 6855921

E-mail: gyc@cctc.cc

Website: Http://www.cctc.cc

#### 7.4 分拨电路板 Handling

Breakaway PC boards (splitting along perforations)

(1). 在电容器或其它贴装后，必须注意因电路板弯曲或变形带来的应力。

(2). 分拨电路板时必须使用专用的夹具，不可以用手拨断。

(1).When splitting the PC board after mounting capacitors and other components, care is required so as not to give any stresses of deflection or twisting to the board.

(2).Board separation should not be done manually, but by using the appropriate devices.

#### 7.5保存 Storage

(1). 在下列环境中保存产品：温度 5~40℃；湿度 ≤70% RH

(2). 产品自生产之日保存期为一年，产品使用之前请勿拆开编带。

(3). 编带拆开后，产品应在三个月内使用。

(4). 高介电常数电容器（X7R, X5R, Y5V）的容值随时间会逐渐减小，所以在电路设计时应充分考虑这一现象。容值减小的电容器在150℃热处理1小时后容值会恢复到初试值。

(1). Keep the storage environment conditions as following: Temperature: 5~40℃; Humidity: ≤70% RH

(2). Don' t open the tape until the parts are to be used, and store them within one year since the date printed on the reel.

(3). Use the chips within 3 months after the tape is opened.

(4). The capacitance value of high dielectric constant capacitors (X7R, X5R, Y5V) will gradually decrease with the passage of time, so this should be taken into consideration in the circuit design. If such a capacitance reduction occurs, a heat treatment of 150℃ for 1 hour will return the capacitance to its initial level.

#### 7.6 环保申明 Environmental Declaration

(1). 我司所有MLCC产品均符合RoHS 2.0标准；

(2). 我司所有MLCC产品均符合最新的REACH法规要求；

(3). 我司所有MLCC产品均符合HF要求。

(1).All MLCC products of our comply with RoHS 2.0;

(2).All MLCC products of our comply with the latest REACH regulations;

(3).All MLCC products of our comply meet HF requirements.

## X-ON Electronics

Largest Supplier of Electrical and Electronic Components

*Click to view similar products for [Multilayer Ceramic Capacitors MLCC - SMD/SMT](#) category:*

*Click to view products by [CCTC](#) manufacturer:*

Other Similar products are found below :

[M39014/02-1218V](#) [M39014/02-1225V](#) [M39014/22-0631](#) [D55342E07B523DR-T/R](#) [NIN-FB391JTRF](#) [NIN-FC2R7JTRF](#)  
[NMC0402NPO220J50TRPF](#) [NMC0402X5R105K6.3TRPF](#) [NMC0402X5R224K6.3TRPF](#) [NMC0402X7R103J25TRPF](#)  
[NMC0402X7R392K50TRPF](#) [NMC0603NPO201J50TRPF](#) [NMC0603NPO330G50TRPF](#) [NMC0603NPO331F50TRPF](#)  
[NMC0603X5R475M6.3TRPF](#) [NMC0603X7R333K16TRPF](#) [NMC0805NPO220J100TRPF](#) [NMC0805NPO820J50TRPF](#)  
[NMC1206X7R102K50TRPF](#) [NMC1206X7R106K10TRPLPF](#) [NMC-H0805X7R472K250TRPF](#) [C1608C0G2A221J](#) [C1608X7R1E334K](#)  
[C2012C0G2A472J](#) [2220J2K00562KXT](#) [CCR06CG153FSV](#) [CDR33BX104AKUR](#) [CDR33BX683AKUS](#) [CGA3E1X7R1C684K](#)  
[CL10C0R8BB8ANNC](#) [M55342H06B20G0R-T/R](#) [C1005X5R0G225M](#) [C2012X7R2E223K](#) [C3216C0G2J272J](#) [D55342E07B35E7R-T/R](#)  
[CDR34BX563BKUS](#) [CDR34BX563BKWS](#) [NMC0402NPO220F50TRPF](#) [NMC0402X7R562J25TRPF](#) [NMC0603NPO102J25TRPF](#)  
[NMC1206X7R332K50TRPF](#) [NMC-P1206X7R104K250TRPLPF](#) [726632-1](#) [CGA6M3X7R1H225K](#) [CGA5L2X7R2A105K](#)  
[CGA3E2X8R1H223K](#) [CDR33BX823AKUR\M500](#) [CDR33BP132BJUR](#) [CDR35BX474AKUR\M500](#) [CDR35BX104BKUR\M500](#)