



CCTC
三环集团

潮州三环（集团）股份有限公司
Chaozhou Three-Circle (Group) Co., Ltd.

地址：广东省潮州市凤塘三环工业城

邮编(Post Code)：515646

ADD：San Huan Industrial District ,Feng Tang Chao Zhou, GuangDong, China

S 系列 MLCC 产品承认书

SPECIFICATION FOR APPROVAL

客户名称：深圳灿容

CUSTOMER:

产品名称：多层片式瓷介电容器

PARTNAME: Multilayer Chip Ceramic Capacitor

产品规格：“S”系列产品

SPECIFICATION:

承认书编号

APPROVAL SHEET NO.: DRAAW108G/0-2020

发出日期

ISSUED DATE: 2020-03-31

制造 MANUFACTURER			客户 CUSTOMER		
批准 APPROVED	审核 CHECKED	经办 PREPARED	批准 APPROVED	审核 CHECKED	经办 PREPARED
梁俊	翟艳明	张国信			

潮州三环（集团）股份有限公司

地址：中国广东省潮州市凤塘三环工业城

电话：86-768-6855932

传真：86-768-6855921

网址：HTTP://WWW.CCTC.CC

品管课



CCTC
三环集团

潮州三环（集团）股份有限公司
Chaozhou Three-Circle (Group) Co., Ltd.

地址：广东省潮州市凤塘三环工业城

邮编(Post Code)：515646

ADD：San Huan Industrial District ,Feng Tang Chao Zhou, GuangDong, China

文件编号		DRAAW108G/0-2020		页数	25
文件名称		多层片式陶瓷电容器(产品承认书)		制订日期	2012.01
版数	制定、修订日期	页数	制定、修订内容	登记者	
B/0	2012-01-11	38	新制定	方千军	
B/1	2012-08-11	36	增加 2225、1808 尺寸的载带尺寸	王彬彬	
C/0	2013-01-10	39	换版	王彬彬	
C/1	2013-06-05	29	新制定	王彬彬	
D/0	2014-05-06	25	换版	张国信	
E/0	2016-05-19	25	换版	张国信	
F/0	2017-07-01	25	换版	张国信	
G/0	2020-02-12	25	换版	张国信	



CCTC
三环集团

潮州三环（集团）股份有限公司

Chaozhou Three-Circle (Group) Co., Ltd.

地址：广东省潮州市凤塘三环工业城

邮编(Post Code)：515646

ADD：San Huan Industrial District ,Feng Tang Chao Zhou,GuangDong,China

产品标准书	编号 Document No.
SPECIFICATION FOR APPROVAL	DRAAW108G/0-2020

目录

1. 产品优势	3
2. 产品应用	4
3. 电容器及介质分类	4
4. 产品命名	5
5. 产品容量范围	6
6. 产品尺寸	7
7. 技术要求和测试条件	8
8. 产品包装	15
9. MLCC 使用注意事项	20



产品标准书 SPECIFICATION FOR APPROVAL	编号 Document No.
	DRAAW108G/0-2020

1. 产品优势 Advantages

1.1 产品结构对比 Structure

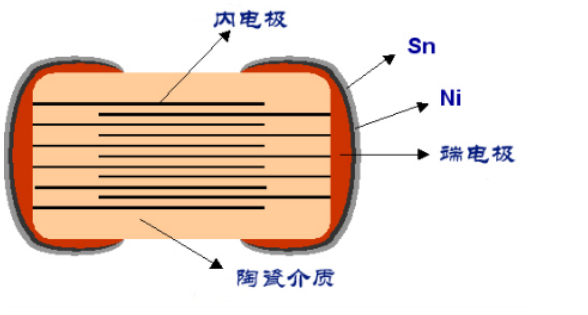
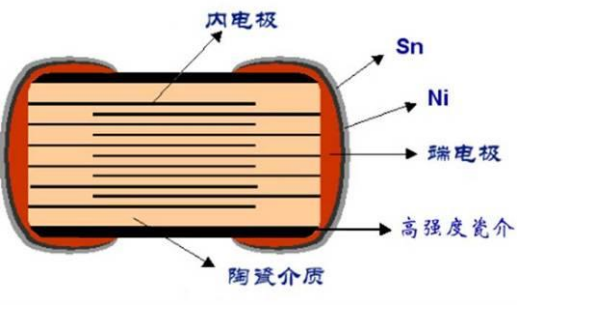
传统产品结构 Structure of traditional product	三明治产品结构 Structure of the sandwich-structure product
	
<p>相对传统产品，三明治机构产品增加了高强度介质层。 The new product called sandwich-structure add high intensity layers .</p>	

1.2 产品强度对比 Product Intensity Contrast

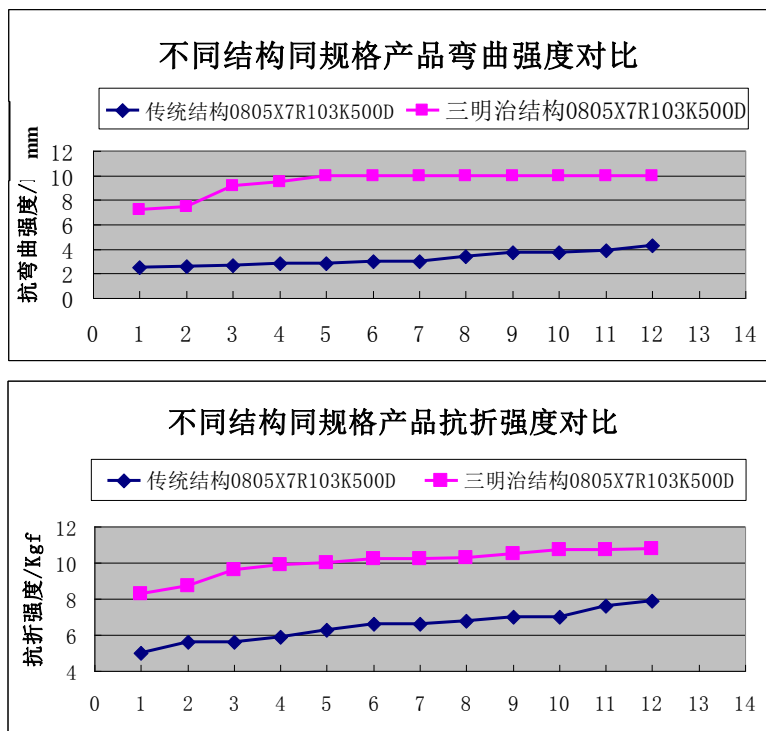

以上对比，表明三明治结构产品强度更高。

Above all , the sandwich-structure products are more stronger .



CCTC
三环集团

潮州三环（集团）股份有限公司
Chaozhou Three-Circle (Group) Co., Ltd.

地址：广东省潮州市凤塘三环工业城

邮编(Post Code)：515646

ADD：San Huan Industrial District ,Feng Tang Chao Zhou,GuangDong,China

产品标准书	编号 Document No.
SPECIFICATION FOR APPROVAL	DRAAW108G/0-2020

2. 产品应用 Product Application

三明治结构产品用于替代低容值常规 X7R 产品，如节能灯、LED 灯、通用电源、工业控制、家电等要求元件具有较好抗折强度以保证产品可靠性的领域。

With better flexural strength to ensure product reliability, Sandwich MLCC is used to replace normal low capacitance X7R MLCCs, which applied to ESL, LED lamp, Power supply, Industrial control, Home appliance fields.

3. 电容器及介质分类 Types of Capacitor and Dielectric Material

※X7R：此类介质材料的电容器为 II 类电容器，具有较高的介电常数，容量比 I 类电容器高，具有较稳定的温度特性，适用于容量范围广，稳定性要求不高的电路中，如隔直、耦合、旁路、鉴频等电路中。

※ X7R: material is a kind of material has high dielectric constant. The capacitor made of this kind material is considered as Class II capacitor whose capacitance is higher than that of class I. These capacitors are classified as having a semi-stable temperature characteristic and used over a wide temperature range, such in these kinds of circuits, DC-blocking, decoupling, bypassing, frequency discriminating etc.



产品标准书 SPECIFICATION FOR APPROVAL	编号 Document No. DRAAW108G/0-2020
-------------------------------------	-------------------------------------

4. 产品命名 Product Parts Numbering System

(例) (example)

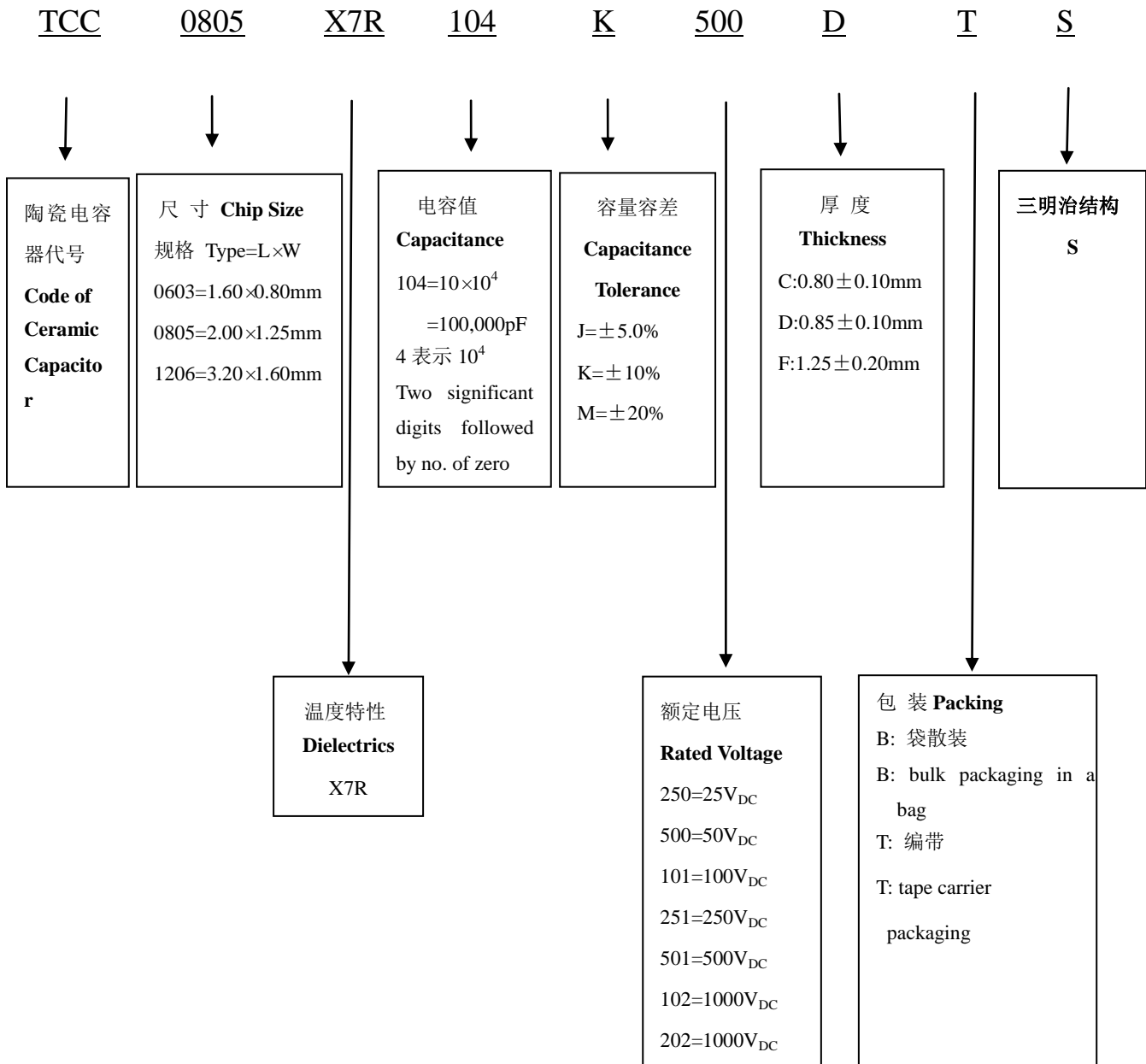



CCTC
三环集团

潮州三环（集团）股份有限公司
Chaozhou Three-Circle (Group) Co., Ltd.

地址：广东省潮州市凤塘三环工业城

邮编(Post Code)：515646

ADD：San Huan Industrial District ,Feng Tang Chao Zhou, GuangDong, China

产品标准书	编号 Document No.
SPECIFICATION FOR APPROVAL	DRAAW108G/0-2020

5. 产品容量范围 Product Capacitance Range

0603 (1608)				0805 (2012)						1206 (3216)									
X7R系列				X7R系列						X7R系列									
Cp	V _{DC}	250	100	50	Cp	V _{DC}	500	250	100	50	25	Cp	V _{DC}	2000	1000	500	250	100	50
221	C	C	C	C	221	D	D	D	D	D	D	151	D/F	D/F	D/F	D/F	D	D	D
331	C	C	C	C	331	D	D	D	D	D	D	221	D/F	D/F	D/F	D/F	D	D	D
471	C	C	C	C	471	D	D	D	D	D	D	331	D/F	D/F	D/F	D/F	D	D	D
561	C	C	C	C	561	D	D	D	D	D	D	471	D/F	D/F	D/F	D/F	D	D	D
681	C	C	C	C	681	D	D	D	D	D	D	561	D/F	D/F	D/F	D/F	D	D	D
821	C	C	C	C	821	D	D	D	D	D	D	681	D/F	D/F	D/F	D/F	D	D	D
102	C	C	C	C	102	D	D	D	D	D	D	821	D/F	D/F	D/F	D/F	D	D	D
222	C	C	C	C	222	D	D	D	D	D	D	102	D/F	D/F	D/F	D/F	D	D	D
332	C	C	C	C	332		D	D	D	D	D	222		D/F	D/F	D/F	D	D	D
472	C	C	C	C	472		D	D	D	D	D	332		D/F	D/F	D/F	D	D	D
562	C	C	C	C	562		D	D	D	D	D	472		D/F	D/F	D/F	D	D	D
682	C	C	C	C	682		D	D	D	D	D	562		F	D/F	D/F	D	D	D
103		C	C	C	103		D	D	D	D	D	682		F	D/F	D/F	D	D	D
153		C	C	C	153			D	D	D	D	103		F	D/F	D/F	D	D	D
183		C	C	C	183			D	D	D	D	153			D/F	D/F	D	D	D
223			C	C	223			D	D	D	D	183			D/F	D/F	D	D	D
273			C	C	273			D	D	D	D	223			D/F	D/F	D	D	D
333			C	C	333			D	D	D	D	273			F	D/F	D	D	D
393			C	C	393			D	D	D	D	333			F	D/F	D	D	D
473			C	C	473			D	D	D	D	393			F	F	D	D	D
563			C	C	563			D	D	D	D	473			F	F	D	D	D
683			C	C	683			D	D	D	D	563				F	D	D	D
104			C	C	104			D	D	D	D	683				F	D	D	D
154					154				D	D	D	104				F	D	D	D
184					184					D	D	154							D
224					224						D	184							D
334					334							224							D
474					474							334							
684					684							474							
105					105							684							
												105							

容量容差： X7R: J(±5.0%); K(±10%); M(±20%)

厚度： C: 0.80±0.10mm、D: 0.85±0.10mm、F: 1.25±0.20mm; 以上容量仅供参考，具体容量取决于使用要求。

Tolerance: X7R: J(±5.0%), K(±10%), M(±20%)

Thickness: C: 0.80±0.10mm、D: 0.85±0.10mm、F: 1.25±0.20mm; Above capacitance for reference only, actual cap. range depends on the standard products.



产品标准书 SPECIFICATION FOR APPROVAL	编号 Document No.
	DRAAW108G/0-2020

6. 产品尺寸 Dimensions

规格：0603、0805、1206。

Chip Size：0603、0805、1206。

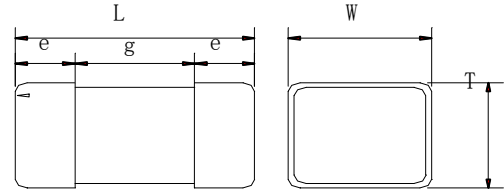

规格 Type	L (mm)	W (mm)	e (mm)	g min (mm)	T (mm)	
0603	1.60±0.10	0.80±0.10	0.2~0.6	0.5	0.80±0.10	---
0805	2.00±0.20	1.25±0.20	0.2~0.7	0.7	0.85±0.10	1.25±0.20
1206	3.20±0.20	1.60±0.20	0.3~0.8	1.6	0.85±0.10	1.25±0.20



产品标准书 SPECIFICATION FOR APPROVAL	编号 Document No. DRAAW108G/0-2020
-------------------------------------	-------------------------------------

7. 技术要求和测试条件 Specification and Test Condition

7.1 外观 Appearance

类型 Dielectrics	技术要求 Specification	测试条件 Testing Condition
X7R	无损伤或异常 No defects or abnormalities	目视检查 Visual inspection.

7.2 尺寸 Dimensions

类型 Dielectrics	技术要求 Specification	测试条件 Testing Condition
X7R	在要求的范围内 Within the specified dimensions	用千分尺 Using calipers on micrometer

7.3 容量 Capacitance

类型 Dielectrics	技术要求 Specification	测试条件 Testing Condition
X7R	在要求的容值容差范围内 Within the specified tolerance J: ±5%; K: ±10%; M: ±20%	1.0±0.2Vrms, 1KHz±10%

备注：测试温度：25℃±3℃，测试湿度：<70%RH. 针对容量 1uF 及以上规格需去老化处理，条件：电容器在 150℃热处理 1 小时，放置 48h 后进行测量。

7.4 损耗 Dissipation Factor

类型 Dielectrics	技术要求 Specification				测试条件 Testing Condition
	规格	U _R	容量范围	DF	
X7R	0603	>25V	C≤0.1 μF	≤5.0%	1.0±0.2Vrms, 1KHz±10%,
		25V	C≤1 μF	≤7.0%	
	0805	>25V	C≤0.47 μF	≤7.0%	
		C>0.47 μF	≤10.0%		
1206	>25V	C≤0.22 μF	≤7.0%		

备注：测试温度：25℃±3℃，测试湿度：<70%RH. 针对容量 1uF 及以上规格需去老化处理，条件：电容器在 150℃热处理 1 小时，放置 48h 后进行测量。

7.5 绝缘电阻 Insulation Resistance

类型 Dielectrics	技术要求 Specification	测试条件 Testing Condition
X7R	U _R ≤50V, 大于 10 GΩ 或 100Ω·F /CR(大于其中较小的数值) U _R ≤50V, More than 10 GΩ or 100Ω·F /CR, whichever is smaller.	U _R ≤50V U _测 =U _R ; 充电时间:60±5 秒、温度:25℃ Charge Time:60±5sec Temperature:25℃
	U _R >50V, 大于 4GΩ 或 100Ω·F/CR (大于其中较小的数值) U _R >50V, More than 4 GΩ or 100Ω·F/CR, whichever is smaller.	U _R ≤400V U _测 =U _R U _R >400V U _测 =400V; 充电时间:60±5 秒、温度:25℃ Charge Time:60±5sec Temperature:25℃

备注：测试温度：25℃±3℃，测试湿度：<70%RH.



产品标准书 SPECIFICATION FOR APPROVAL	编号 Document No.
	DRAAW108G/0-2020

7.6 耐电压 Dielectric Strength

类型 Dielectrics	额定电压范围 Rated voltage range	耐电压性能测试方法 Measuring Method
X7R	$U_R \leq 50V$	施加额定电压的 250%，5 秒，最大电流不超过 50mA Force 250% Rated voltage for 5second. Max..current should not exceed 50 mA.
	$100V \leq U_R < 500V$	施加额定电压的 200%，5 秒，最大电流不超过 50mA Force 200% Rated voltage for 5second. Max..current should not exceed 50 mA.
	$500V \leq U_R < 1000V$	施加额定电压的 150%，5 秒，最大电流不超过 50mA Force 150% Rated voltage for 5second. Max..current should not exceed 50 mA.
	$1000V \leq U_R < 2000V$	施加额定电压的 150%，5 秒，最大电流不超过 50mA Force 150% Rated voltage for 5second. Max..current should not exceed 50 mA.
	$U_R \geq 2000V$	施加额定电压的 120%，5 秒，最大电流不超过 30mA Force 120% Rated voltage for 5second. Max..current should not exceed 30 mA.



产品标准书 SPECIFICATION FOR APPROVAL	编号 Document No. DRAAW108G/0-2020
-------------------------------------	--

7.7 静电容量温度特性 Temperature Coefficient of Capacitance

类型 Dielectrics	技术要求 Specification	测试条件 Testing Condition												
X7R	容量变化在 ±15% 以内 Capacitance change within ±15%	<p>按系列温度顺序测试电容容量 Measure capacitance under follow table list temperature: 在 140~150℃ 预处理 1 小时, 放置 24h 后进行测量。</p> <table border="1" style="margin-left: auto; margin-right: auto;"> <thead> <tr> <th style="text-align: center;">步骤 STEP</th> <th style="text-align: center;">X7R</th> </tr> </thead> <tbody> <tr> <td style="text-align: center;">1</td> <td style="text-align: center;">25 ±2</td> </tr> <tr> <td style="text-align: center;">2</td> <td style="text-align: center;">-55 ±3</td> </tr> <tr> <td style="text-align: center;">3</td> <td style="text-align: center;">25 ±2</td> </tr> <tr> <td style="text-align: center;">4</td> <td style="text-align: center;">125 ±3</td> </tr> <tr> <td style="text-align: center;">5</td> <td style="text-align: center;">25 ±2</td> </tr> </tbody> </table> <p>X7R 与 25℃ 时的电容容量相比较, 电容容量在温度范围内的变化在要求的范围之内。 The ranges of capacitance change compared within the above 25℃ value over the temperature ranges shall be within the specified ranges.</p>	步骤 STEP	X7R	1	25 ±2	2	-55 ±3	3	25 ±2	4	125 ±3	5	25 ±2
步骤 STEP	X7R													
1	25 ±2													
2	-55 ±3													
3	25 ±2													
4	125 ±3													
5	25 ±2													

7.8 附着力 Adhesion

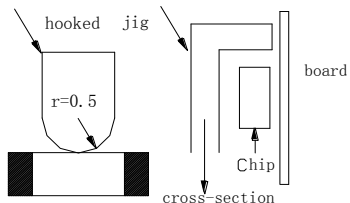
类型 Dielectrics	技术要求 Specification	测试条件 Testing Condition
X7R	端电极无松动, 也无其它不良现象 No removal of the terminations or other defect shall occur.	<p>施加 6N 的压力, 并保持 10±1 秒 The pressurizing force shall be 6N (=600g*f) and the duration of application shall be 10±1sec.</p> 



产品标准书	编号 Document No.
SPECIFICATION FOR APPROVAL	DRAAW108G/0-2020

7.9 可焊性 Solderability of Termination

类型 Dielectrics	技术要求 Specification	测试条件 Testing Condition
X7R	端电极挂锡面积不小于 95%，针孔或粗糙面积小于 5% 95% min. coverage of both terminal electrodes and less than 5% have pin holes or rough spots.	锡炉温度：245±5℃ 浸入时间：2±1 秒 两侧端电极完全浸入焊锡炉 Solder temperature: 245±5℃ Dipping time: 2±1 seconds. Completely soak both terminal electrodes in solder

7.10 耐焊性 Resistance to leaching

类型 Dielectrics	技术要求 Specification	测试条件 Testing Condition
X7R	端电极挂锡面积不小于 95%，针孔或粗糙面积小于 5%，外观无开裂 95% min. coverage of both terminal electrodes and less than 5% have pin holes or rough spots. No remarkable visual damage.	预热：120℃~150℃/60 秒 锡炉温度：270±5℃ 浸入时间：10±1 秒 两侧端电极完全浸入焊锡炉 Solder temperature: 270±5℃ preheated: 120℃~150℃/60sec Dipping time: 10±1 seconds. Completely soak both terminal electrodes in solder

7.11 端电极结合强度 Bending

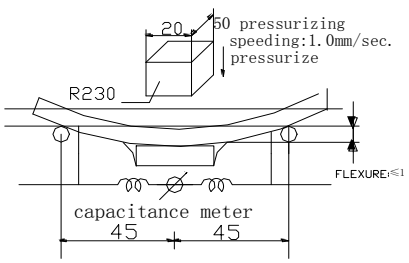
类型 Dielectrics	技术要求 Specification	测试条件 Testing Condition
X7R	无可见损伤； 容量变化小于等于 ±10% No remarkable visual damage Cp change ≤ ±10%	将片状电容器安装在测试夹具上，按图所示方向以 1.0mm/s 的速率施加压力，弯曲 1mm。 Solder the capacitor on testing substrate and put it on testing stand. The middle part of substrate shall successively be pressurized by pressuring rod at a rated of about 1.0mm/sec. Until the deflection become means of the 1.0mm. 



产品标准书	编号 Document No.
SPECIFICATION FOR APPROVAL	DRAAW108G/0-2020

7.12 耐焊接热 Resistance to Soldering Heat

类型 Dielectrics	技术要求 Specification	测试条件 Testing Condition
X7R	无明显可见损伤 容量变化在 $\pm 7.5\%$ 以内 DF 满足产品初始值的要求 IR 满足产品初始值的要求 No remarkable visual damage Cp change within $\pm 7.5\%$ DF meets initial standard value. IR meets initial standard value.	焊接温度: $270 \pm 5^\circ\text{C}$ 预热: $120 \sim 150^\circ\text{C}$ 60 秒 浸入时间: 10 ± 1 秒 在室温下放置 24 ± 2 (COG) 或 48 ± 4 (X7R) 小时以后测量 试验后在标准条件下恢复 Soldering temperature: $270 \pm 5^\circ\text{C}$ Preheating: $120 \sim 150^\circ\text{C}$ 60sec. Dipping time: 10 ± 1 seconds. Measurement to be made after being kept at room temperature for 48 ± 4 (X7R) hours. Recovery for the following period under the standard condition after test.

7.13 温度快速循环 Temperature Cycle

类型 Dielectrics	技术要求 Specification	测试条件 Testing Condition															
X7R	无明显可见损伤 容量变化在 $\pm 7.5\%$ 以内 No remarkable visual damage Cp change within $\pm 7.5\%$	按下列步骤进行 5 次循环： To perform 5 cycles of the stated environment <table border="1" style="width: 100%; border-collapse: collapse;"> <thead> <tr> <th>步骤 Step</th> <th>温度 Temperature</th> <th>时间 Time</th> </tr> </thead> <tbody> <tr> <td style="text-align: center;">1</td> <td>下限类别温度 $+0/-3^\circ\text{C}$ Min. operating Temp. $+0/-3^\circ\text{C}$</td> <td style="text-align: center;">30min</td> </tr> <tr> <td></td> <td style="text-align: center;">25°C</td> <td style="text-align: center;">2~3 in</td> </tr> <tr> <td style="text-align: center;">3</td> <td>上限类别温度 $+3/-0^\circ\text{C}$ Max. operating Temp. $+3/-0^\circ\text{C}$</td> <td style="text-align: center;">30 mi</td> </tr> <tr> <td style="text-align: center;">4</td> <td style="text-align: center;">25°C</td> <td style="text-align: center;">2~ min</td> </tr> </tbody> </table> 在室温下放置 48 ± 4 (X7R) 小时以后测量 Measurement to be made after being kept at room temperature for 48 ± 4 hrs (X7R) at room temperature, then measure.	步骤 Step	温度 Temperature	时间 Time	1	下限类别温度 $+0/-3^\circ\text{C}$ Min. operating Temp. $+0/-3^\circ\text{C}$	30min		25°C	2~3 in	3	上限类别温度 $+3/-0^\circ\text{C}$ Max. operating Temp. $+3/-0^\circ\text{C}$	30 mi	4	25°C	2~ min
步骤 Step	温度 Temperature	时间 Time															
1	下限类别温度 $+0/-3^\circ\text{C}$ Min. operating Temp. $+0/-3^\circ\text{C}$	30min															
	25°C	2~3 in															
3	上限类别温度 $+3/-0^\circ\text{C}$ Max. operating Temp. $+3/-0^\circ\text{C}$	30 mi															
4	25°C	2~ min															



产品标准书	编号 Document No.
SPECIFICATION FOR APPROVAL	DRAAW108G/0-2020

7.14 稳态湿热 Moisture Resistance ,steady state

类型 Dielectrics	技术要求 Specification	测试条件 Testing Condition
X7R	外观无明显可见损伤 容量变化在 $\pm 2.5\%$ 以内 DF为初始值的2倍以下 IR:大于 $1000M\Omega$ 或 $10\Omega \cdot F$ (取较小值) No remarkable visual damage Cp change within $\pm 2.5\%$ DF:Not more than 2 times of initial value R*C $\geq 1000M\Omega$ or $10\Omega \cdot F$, whichever is smaller	测试温度: $40 \pm 2^\circ C$ 湿度: 90~95% RH 测试时间: 500 ± 12 hrs 在室温下放置 48 ± 4 小时以后测量 Test temperature: $40 \pm 2^\circ C$ Humidity: 90~95% RH Testing time: 500 ± 12 hrs Measurement to be made after being kept at room temperature for 48 ± 4 hrs

7.15 耐湿负荷 Damp heat with load

类型 Dielectrics	技术要求 Specification	测试条件 Testing Condition
X7R	外观无明显可见损伤 容量变化在 $\pm 2.5\%$ 以内 DF为初始值的2倍以下 IR: 大于 $500M\Omega$ 或 $5\Omega \cdot F$ (取较小值) No remarkable visual damage Cp change $\leq \pm 2.5\%$ DF:Not more than 2 times of initial value R*C $\geq 500M\Omega$ or $5\Omega \cdot F$, whichever is smaller	测试温度: $40 \pm 2^\circ C$ 湿度: 90~95% RH 电压: 额定电压 测试时间: 500 ± 12 hrs 在室温下放置 48 ± 4 (X7R) 小时以后测量 *在 $40 \pm 2^\circ C$ 温度下, 将电容器加额定直流电压 1hrs. 去掉电压, 将电容器在室温下放置 48 ± 4 hrs 测量初始电容值。 Test temperature: $40 \pm 2^\circ C$ Humidity: 90~95% RH Voltage: 100% of the rated voltage Testing time: 500 ± 12 hrs Measurement to be made after being kept at room temperature for 48 ± 4 hrs (X7R) *Apply the rated DC voltage for 1 hour at $40 \pm 2^\circ C$. Remove and let sit for 48 ± 4 hrs at room temperature. Perform the initial measurement.
备注：该项可靠性试验仅适用于常规产品，不适用于中高压产品。		



产品标准书	编号 Document No.
SPECIFICATION FOR APPROVAL	DRAAW108G/0-2020

7.16 耐久性 Life Test

类型 Dielectrics	技术要求 Specification	测试条件 Testing Condition
X7R	外观无明显可见损伤 容量变化在 12.5% 以内 DF 为初始值的 2 倍以下 IR: 大于 1000MΩ 或 5Ω·F (取较小值) No remarkable visual damage Cp change ≤ ±12.5% DF: Not more than 2 times of initial value R*C ≥ 1000MΩ or 5Ω·F, whichever is smaller	测试温度：上限类别温度 ±3℃ 电压： U _R < 100V 1.5 倍额定电压 测试时间：1000 小时 在室温下放置 48 ± 4 (X7R) 小时以后测量 Test temperature: Max. Operating Temp. ±3℃ Voltage: U _R < 100V 150% of the rated voltage Testing time: 1000 hrs Measurement to be made after being kept at room temperature for 48 ± 4 hrs (X7R)

备注：该项可靠性试验仅适用于常规产品，不适用于中高压产品。



产品标准书 SPECIFICATION FOR APPROVAL	编号 Document No.
	DRAAW108G/0-2020

8. 产品包装 Packing

8.1 袋式散装 Bulk Packing

10000 个/袋或按客户要求。Standard packing 10Kpcs/bag; others are according to customer request.

8.2 编带式包装 Tape Packing

规格 Type	尺寸 Size (mm)			编带数量(个/盘 pcs/reel)	
	长度 L	宽度 W	厚度 T	纸带 Paper Tape	塑料带 Plastic Tape
0603	1.60	0.80	0.80	4,000	N/A
0805	2.00	1.25	<0.85	4,000	N/A
1206	3.20	1.60	≤0.85	4,000	N/A
			>0.85	N/A	2,000

8.2.1 纸带尺寸 Dimensions of Packing Paper

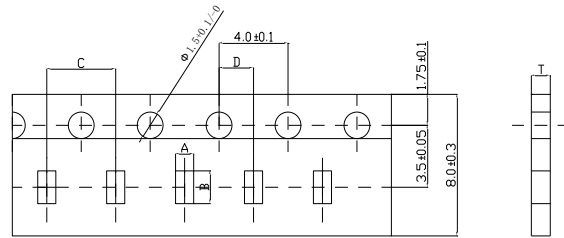

Type	A	B	C	D	T
0603	1.05±0.10	1.85±0.10	4.0±0.10	2.0±0.10	1.1max
0805	1.55±0.15	2.3±0.15	4.0±0.10	2.0±0.10	1.1max
1206	1.95±0.15	3.5±0.15	4.0±0.10	2.0±0.10	1.1max

(单位 unit:毫米 mm)



产品标准书 SPECIFICATION FOR APPROVAL	编号 Document No.
	DRAAW108G/0-2020

8.2.2 塑料带尺寸 Dimensions of Embossed Packing

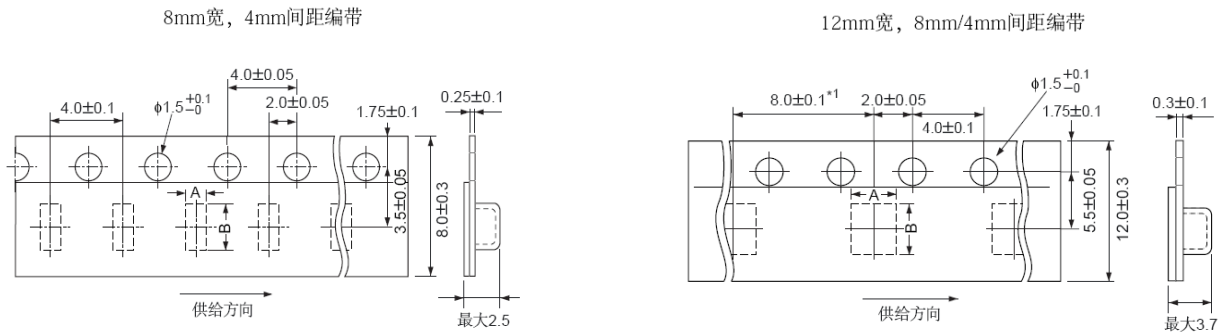

A: 1.45 ± 0.20 B: 2.25 ± 0.20 (0805) A: 1.95 ± 0.20 B: 3.50 ± 0.20 (1206) (单位 unit:毫米 mm)

8.2.3 编带盘尺寸 Dimensions of Reel

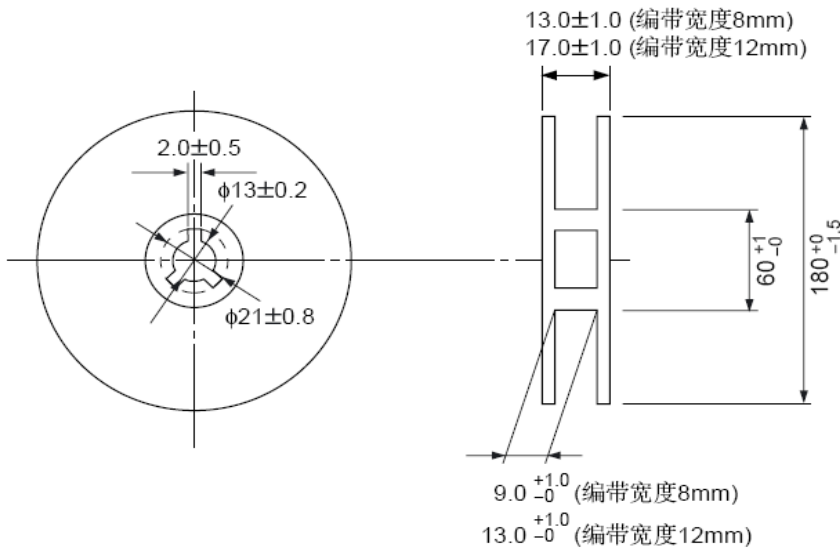

8.2.4 编带方式 Taping Figure

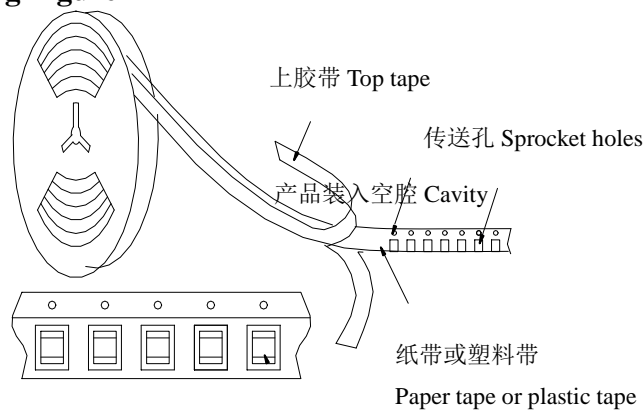



产品标准书 SPECIFICATION FOR APPROVAL	编号 Document No. DRAAW108G/0-2020
-------------------------------------	--

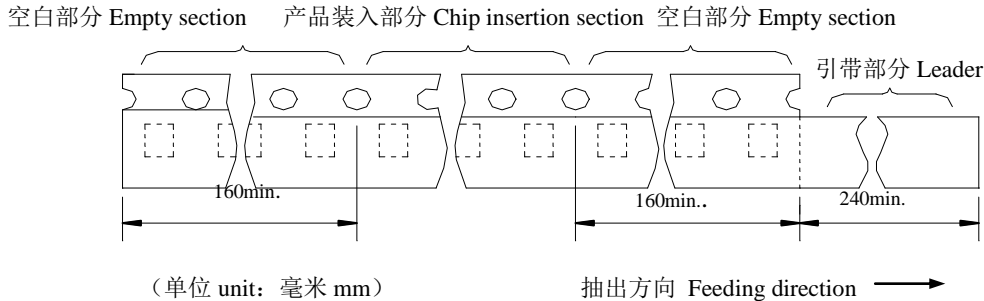

8.2.5 编带方法 Taping Method

- ① 包装电容器的编带是顺时针卷绕的，由上往下的方向拉出编带时，传送孔处于编带的右侧。
- ② 在编带的前端，至少留出 5 个间距的引出带。
- ③ 在编带时，必须按下图留出引出带部分或空白部分。
- ④ 在盘带的安装中的产品装错的数量每盘必须小于表示数量的 0.1% 或 1 个为限，不连续发生错误。
- ⑤ 上胶带和下胶带不应超出编带的边缘，不能挡住传送孔。
- ⑥ 传送孔的累计误差为 10 个间距：±0.3 毫米以内。
- ⑦ 上胶带的剥离力矩应在 0.1 至 0.6 牛顿以内，其方向如下图所示。

- ① Tapes for capacitors are wound clockwise. The sprocket holes are to the right as the tape is pulled toward the user.
- ② The top tape and base tape are not attached at the end of the tape for a minimum of 5 pitches.
- ③ Part of the leader and part of the empty tape shall be attached to the end of the tape as follows.
- ④ Missing capacitors number within 0.1% of the number per reel or 1pc, whichever is greater, and are not continuous.
- ⑤ The top tape and bottom tape shall not protrude beyond the edges of the tape and shall not cover sprocket holes.
- ⑥ Cumulative tolerance of sprocket holes, 10 pitches: ±0.3mm.
- ⑦ Peeling off force: 0.1 to 0.6N in the direction shown down.

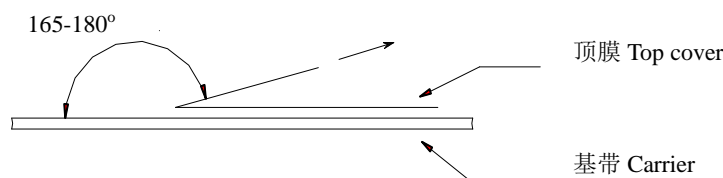



产品标准书 SPECIFICATION FOR APPROVAL	编号 Document No. DRAAW108G/0-2020
-------------------------------------	--

8.2.6 产品标签 Reel Label

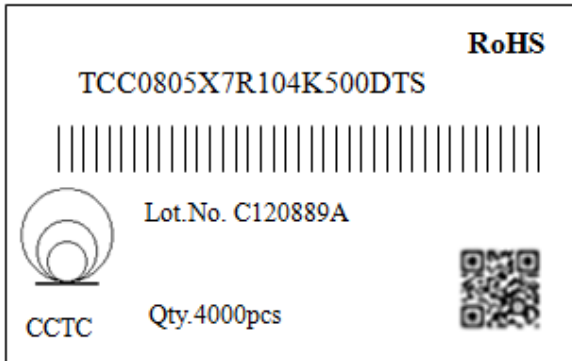

标签内容 The Contents of Label

- (1) TCC 0805 X7R 104 K 500 D T S
① ② ③ ④ ⑤ ⑥ ⑦ ⑧ ⑨

① 陶瓷电容器代号 Code of Ceramic Capacitor

② 尺寸 chip size, ③ 温度特性 dielectrics, ④ 容量 capacitance, ⑤ 容量容差 tolerance, ⑥ 额定电压 rated voltage, ⑦ 厚度 thickness, ⑧ 包装 packing, ⑨ 三明治

(2) 产品批号 Lot. No.: C120889A

(3) 数量 Qty: 4000pcs

(4) RoHS: GREEN PARTS 绿色物料

8.2.7. 外包装 Package

8.2.7.1 包装箱 Carton

8.2.7.1.1 包装箱尺寸 Carton Size

L	W	H
41cm	38.5cm	20.2cm

8.2.7.1.2 数量： 240Kpcs /箱 The Quantity: 240Kpcs /one carton

1 内包装盒=40,000PCS 1 INNER BOX=40,000PCS

1 包装箱 =40,000PCS × 6 包装盒=240,000PCS 1 CARTON=40,000PCS × 6BOX=240,000PCS

RoHS 标识(根据客户要求张贴) according to customer request



产品标准书 SPECIFICATION FOR APPROVAL	编号 Document No. DRAAW108G/0-2020
-------------------------------------	--

8.2.7.2 内包装盒 Inner Box

8.2.7.2.1 包装盒尺寸 Size

L	W	H
18.5cm	6.5cm	19cm

8.2.7.2.2 数量：40Kpcs /盒

1 盘=4000PCS 1 REEL=4,000PCS

1 包装盒=4,000PCS × 10 盘 =40,000PCS 1 INNER BOX=4,000PCS × 10REEL =40,000PCS



产品标准书 SPECIFICATION FOR APPROVAL	编号 Document No. DRAAW108G/0-2020
-------------------------------------	-------------------------------------

9. MLCC 使用注意事项 Precautions on the use of MLCC

9.1 电路板设计 PCB Design

9.1.1 电路板图案设计 Design of Land-patterns

下面图和表格给出了部分推荐的设计图案，可以防止安装时焊锡量过多。

同时也给出了不正确的图案。

The following diagrams and tables show some examples recommended patterns to prevent excessive solder amounts (larger fillets which above the component end terminations)

Examples of improper pattern designs are also shown.

电路板设计推荐图案尺寸：

Recommended land dimensions for a typical chip capacitor land patterns for PCBs

波峰焊接时推荐设计的尺寸 (单位: mm):

Recommended land dimensions for wave-soldering (unit: mm)

规格 SIZE		0603	0805	1206
尺寸	L	1.6	2.0	3.2
	W	0.8	1.25	1.6
A		0.8~1.0	1.0~1.4	1.8~2.5
B		0.5~0.8	0.8~1.5	0.8~1.7
C		0.6~0.8	0.9~1.2	1.2~1.6

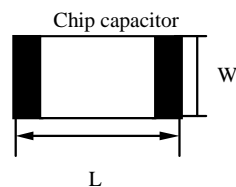
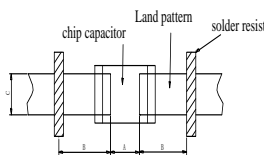

再流焊接时推荐设计的尺寸 (单位: mm)

Recommended land dimensions for reflow-soldering (unit: mm)

规格 SIZE		0603	0805	1206
尺寸	L	1.6	2.00	3.2
	W	0.8	1.25	1.6
A		0.6~0.8	0.8~1.2	1.8~2.5
B		0.6~0.8	0.8~1.2	1.0~1.5
C		0.6~0.8	0.9~1.6	1.2~2.0

过量的焊锡会影响产品抵抗机械应力的能力，因此在设计图案时应引起注意。

Excess solder can affect the ability of chips to withstand mechanical stresses. Therefore, please take proper precautions when designing land-patterns.

在应用中一些焊接好与坏的情况：

Examples of good and bad solder application



产品标准书	编号 Document No.
SPECIFICATION FOR APPROVAL	DRAAW108G/0-2020

项目 Item	不推荐结构 Not recommended	推荐结构 Recommended
片状元件和带引线的元件的混合焊接 Mixed mounting of SMD and leaded component		
靠近底座的焊接 Component placement close to the chassis		
在片状元件附近带引线元件的焊接 Hand-soldering of leaded components near mounted components		

9.1.2 图案结构

Pattern configurations

下面是电容器安装好与坏例子。选择贴装位置，应尽可能减小电路板在弯曲时受到的机械应力。

The following are examples of good and bad capacitor layout, SMD capacitors should be located to minimize any possible mechanical stresses from board warp or deflection..

	不推荐结构 Not recommended	推荐结构 Recommended
电路板弯曲 Deflection of the board		

对于电路板分拨的电容器，在分拨时受到的机械应力大小与电容器的安装有关。下面推荐了一些好的设计。

To layout the capacitors for the breakaway PC board, it should be noted that the amount of mechanical stresses given depending on capacitor layout. The example below shows recommendations for better design.



产品标准书	编号 Document No.
SPECIFICATION FOR APPROVAL	DRAAW108G/0-2020

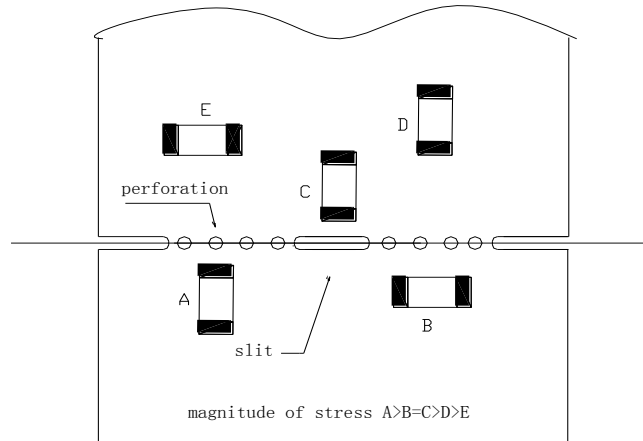

在沿着分拨线分拨电路板时，对产品施加的机械应力与使用的方法关系很大。分折电路板时片状元件受到的疲劳按照如下顺序增大：分折、剪切、V型槽、穿孔。因此，贴装时应该考虑电路板的分拨过程。

When breaking PC boards along their perforations, the amount of mechanical stress on the capacitors can vary according to the method used. The following methods are listed in order from least stressful to most stressful: push-back, slit, -grooving, and perforation. Thus, any ideal SMD capacitor layout must also consider the PCB splitting procedure.

9.2 自动贴装注意事项 Considerations for automatic placement

贴装机的调整 Adjustment of mounting machine

- ①. 产品在电路板贴装时，不应该受到过大的冲击。
- ②. 必须定期对吸头和定位爪进行检查、维修和更换
- ①. Excessive impact load should not be imposed on the capacitors when mounting the PC boards.
- ②. The maintenance and inspection of the mounters should be conducted periodically.

	不推荐结构 Not recommended	推荐结构 Recommended
单面贴装 Single-sided mounting	crack	supporting pin
双面贴装 Double-sided mounting	solder peeling crack	supporting pin



产品标准书 SPECIFICATION FOR APPROVAL	编号 Document No. DRAAW108G/0-2020
-------------------------------------	--

9.3 推荐焊接曲线 Recommended soldering profile

9.3.1 说明：① 产品推荐使用回流焊接工艺；② 大尺寸产品适用于回流焊接工艺

9.3.1 Re: ① flow Soldering is recommended; ② flow soldering is suitable for bigger size MLCCs

9.3.2 锡铅焊接曲线 Recommended Sn&Pb soldering profile

回流焊 Reflow soldering

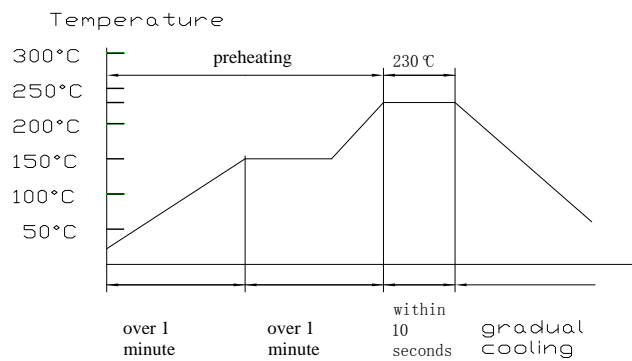

注意 Caution

① . 理想状况的焊锡高度为电容器厚度的 1/3 ~1/2，如下图所示：

① .The ideal condition is to have solder mass (fillet) controlled to 1/3 ~1/2 of the thickness of the capacitor, as shown below:

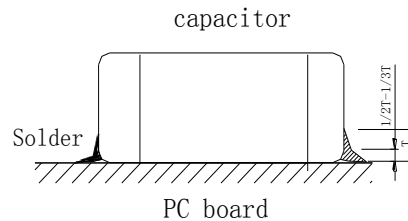

②. 过长的焊接时间会影响端头的可焊性，焊接时间尽可能保持与推荐时间一致。

②. Because excessive dwell times can detrimentally affect solderability, soldering duration should be kept as close to recommended times as possible.

波峰焊 Wave solder profile

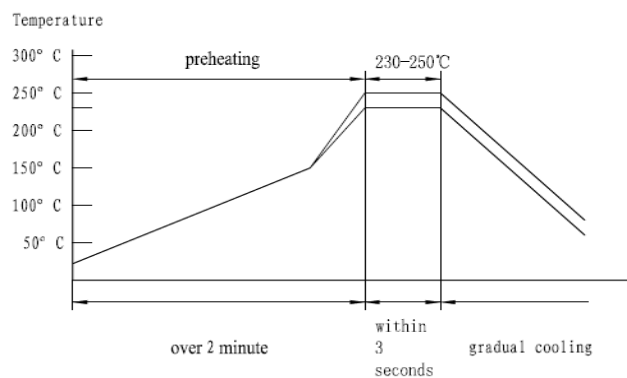



产品标准书 SPECIFICATION FOR APPROVAL	编号 Document No.
	DRAAW108G/0-2020

注意 Caution

- ①.确保电容器充分预热。
- ②.产品预热和焊接温度差不超过 100~130℃。
- ③.焊接后尽可能慢速冷却。
- ①.Make sure the capacitors are preheated sufficiently.
- ②.The temperature difference between the capacitor and melted solder should not be greater than 100 to 130℃.
- ③.Cooling after soldering should be gradual as possible.

手工焊接 Hand soldering

条件:

预热	烙铁头温度	烙铁功率	烙铁头直径	焊接时间	锡膏量	限制条件
$\Delta \leq 130^{\circ}\text{C}$	最高350℃	最大20W	建议1mm	最长5s	$\leq 1/2$ 芯片厚度	请勿使用烙铁头直接接触陶瓷原件

注意 Caution

- ①.用尖端最大直径 1.0mm 功率 20W 的焊接烙铁。
- ②.焊接烙铁不要直接接触产品。
- ①.Use a 20w soldering iron with a maximum tip diameter of 1.0mm.
- ②.The soldering iron should not directly touch the capacitor.

9.3.3 无铅焊接曲线 Recommended Pb-Free soldering profile

回流焊接 Reflow soldering

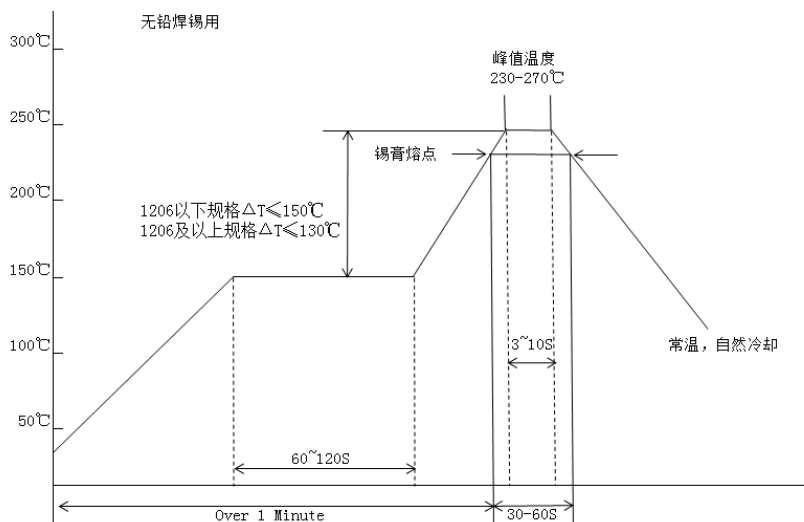



产品标准书	编号 Document No.
SPECIFICATION FOR APPROVAL	DRAAW108G/0-2020

波峰焊接 Wave solder profile

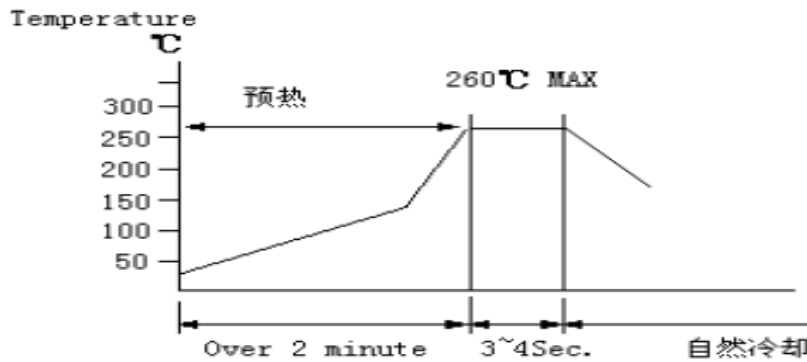

9.4 分拨电路板 Handling

Breakaway PC boards (splitting along perforations)

- (1).在电容器或其它贴装后，必须注意因电路板弯曲或变形带来的应力。
- (2).分拨电路板时必须使用专用的夹具，不可以用手拨断。

- (1).When splitting the PC board after mounting capacitors and other components, care is required so as not to give any stresses of deflection or twisting to the board.
- (2).Board separation should not be done manually, but by using the appropriate devices.

9.5 保存 Storage

- (1).在下列环境中保存产品：温度 5~40°C；湿度 ≤70% RH
- (2).产品自生产之日保存期为一年，产品使用之前请勿拆开编带。
- (3).编带拆开后，产品应在三个月内使用。
- (4).高介电常数电容器的容值随时间会逐渐减小，所以在电路设计时应充分考虑这一现象。容值减小的电容器在 150°C 热处理 1 小时后容值会恢复到初试值。

(1). Keep the storage environment conditions as following:

Temperature: 5~40°C

Humidity: ≤70% RH

- (2). Don't open the tape until the parts are to be used, and store them within one year since the date printed on the reel.
- (3). Use the chips within 3 months after the tape is opened.
- (4). The capacitance value of high dielectric constant capacitors will gradually decrease with the passage of time, so this should be taken into consideration in the circuit design. If such a capacitance reduction occurs, a heat treatment of 150°C for 1 hour will return the capacitance to its initial level.

X-ON Electronics

Largest Supplier of Electrical and Electronic Components

Click to view similar products for [Multilayer Ceramic Capacitors MLCC - SMD/SMT](#) category:

Click to view products by [CCTC](#) manufacturer:

Other Similar products are found below :

[M39014/01-1467](#) [M39014/02-1218V](#) [M39014/02-1225V](#) [M39014/02-1262V](#) [M39014/02-1301](#) [M39014/22-0631](#) [1210J5000102JCT](#)
[1210J2K00102KXT](#) [1210J5000103KXT](#) [1210J5000223KXT](#) [D55342E07B379BR-TR](#) [D55342E07B523DR-T/R](#) [1812J1K00103KXT](#)
[1812J1K00473KXT](#) [1812J2K00680JCT](#) [1812J4K00102MXT](#) [1812J5000102JCT](#) [1812J5000103JCT](#) [1812J5000682JCT](#) [NIN-FB391JTRF](#)
[NIN-FC2R7JTRF](#) [NPIS27H102MTRF](#) [C1206C101J1GAC](#) [C1608C0G1E472JT000N](#) [C2012C0G2A472J](#) [2220J2K00101JCT](#)
[KHC201E225M76N0T00](#) [LRC-LRF1206LF-01R025FTR1K](#) [1812J1K00222JCT](#) [1812J2K00102KXT](#) [1812J2K00222KXT](#)
[1812J2K00472KXT](#) [2-1622820-7-CUT-TAPE](#) [2220J3K00102KXT](#) [2225J2500824KXT](#) [CCR07CG103KM](#) [CGA2B2C0G1H010C](#)
[CGA2B2C0G1H040C](#) [CGA2B2C0G1H050C](#) [CGA2B2C0G1H060D](#) [CGA2B2C0G1H070D](#) [CGA2B2C0G1H151J](#) [CGA2B2C0G1H1R5C](#)
[CGA2B2C0G1H2R2C](#) [CGA2B2C0G1H3R3C](#) [CGA2B2C0G1H680J](#) [CGA2B2C0G1H6R8D](#) [CGA2B2X8R1H221K](#) [CGA2B2X8R1H472K](#)
[CGA3E1X7R1C474K](#)