

NPN SILICON PLANAR EPITAXIAL TRANSISTORS

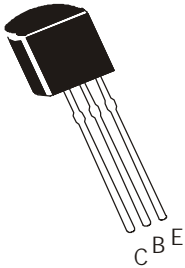

BC182, A, B
BC183, A, B, C
BC184, B, C

TO-92
Plastic Package
For Lead Free Parts, Device
Part # will be Prefixed with
"T"

Amplifier Transistors

ABSOLUTE MAXIMUM RATINGS ($T_a=25^\circ\text{C}$)

DESCRIPTION	SYMBOL	BC182	BC183	BC184	UNITS
Collector Emitter Voltage	V_{CEO}	50	30	30	V
Collector Base Voltage	V_{CBO}	60	45	45	V
Emitter Base Voltage	V_{EBO}	6.0			V
Collector Current Continuous	I_C	100			mA
Power Dissipation at $T_a=25^\circ\text{C}$	P_D	350			mW
Derate Above 25°C		2.8			mW/ $^\circ\text{C}$
Power Dissipation at $T_c=25^\circ\text{C}$	P_D	1.0			W
Derate Above 25°C		8.0			mW/ $^\circ\text{C}$
Operating And Storage Junction Temperature Range	T_j, T_{stg}	- 55 to +150			$^\circ\text{C}$

THERMAL RESISTANCE

Junction to Case	$R_{th(j-c)}$	125	$^\circ\text{C/W}$
Junction to Ambient in free air	$R_{th(j-a)}$	357	$^\circ\text{C/W}$

ELECTRICAL CHARACTERISTICS ($T_a=25^\circ\text{C}$ unless specified otherwise)

DESCRIPTION	SYMBOL	TEST CONDITION	MIN	TYP	MAX	UNITS
Collector Emitter Voltage	V_{CEO}	$I_C=2\text{mA}, I_B=0$				
		BC182	50			V
		BC183/BC184	30			V
Collector Base Voltage	V_{CBO}	$I_C=10\mu\text{A}, I_E=0$				
		BC182	60			V
		BC183/BC184	45			V
Emitter Base Voltage	V_{EBO}	$I_E=100\mu\text{A}, I_C=0$	6.0			V
Collector Cut Off Current	I_{CBO}	$V_{CB}=50\text{V}, I_E=0$			15	nA
		$V_{CB}=30\text{V}, I_E=0$	BC182			15
						BC183/184
Emitter Cut Off Current	I_{EBO}	$V_{EB}=4\text{V}, I_C=0$			15	nA

BC182_184Rev_1 201205E

NPN SILICON PLANAR EPITAXIAL TRANSISTORS

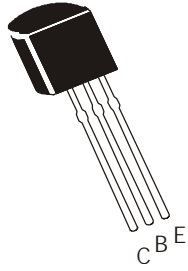

BC182, A, B
BC183, A, B, C
BC184, B, C

TO-92
Plastic Package
 For Lead Free Parts, Device
 Part # will be Prefixed with
 "T"

ELECTRICAL CHARACTERISTICS (T_a=25°C unless specified otherwise)

DESCRIPTION	SYMBOL	TEST CONDITION	MIN	TYP	MAX	UNITS
DC Current Gain	h _{FE}	I _C =10μA, V _{CE} =5V				
		BC182/183	40			
		BC184	100			
		I _C =2mA, V _{CE} =5V				
		BC182	120		500	
		BC183	120		800	
		BC184	240		800	
		I _C =100mA, V _{CE} =5V				
		BC182	80			
		BC183	80			
		BC184	130			
Collector Emitter Saturation Voltage	V _{CE (sat)}	I _C =10mA, I _B =0.5mA			0.25	V
		*I _C =100mA, I _B =5mA			0.60	V
Base Emitter Saturation Voltage	V _{BE (sat)}	*I _C =100mA, I _B =5mA			1.2	V
Base Emitter On Voltage	V _{BE (on)}	I _C =100μA, V _{CE} =5V		0.50		V
		I _C =2mA, V _{CE} =5V	0.55		0.70	V
		I _C =100mA, V _{CE} =5V		0.83		V

SMALL SIGNAL CHARACTERISTICS

DESCRIPTION	SYMBOL	TEST CONDITION	MIN	TYP	MAX	UNITS
Transistors Frequency	f _T	I _C =0.5mA, V _{CE} =3V, f=100MHz				
		BC182		100		MHz
		BC183		120		MHz
		BC184		140		MHz
		I _C =10mA, V _{CE} =5V, f=100MHz	150			MHz
Output Capacitance	C _{ob}	V _{CB} =10V, I _E =0, f=1MHz			5.0	pF
Input Capacitance	C _{ib}	V _{BE} =0.5V, I _C =0, f=1MHz		8.0		pF
Small Signal Current Gain	h _{fe}	I _C =2mA, V _{CE} =5V, f=1KHz				
		BC182	125		500	
		BC183	125		900	
		BC184	240		900	
		BC182A/BC183A	125		260	
		BC182B/183B/184B	240		500	
		BC183C/184C	450		900	
Noise Figure	NF	I _C =0.2mA, V _{CE} =5V, R _S =2 kΩ, f=30Hz to 15KHz			4.0	dB
		BC184				
		I _C =0.2mA, V _{CE} =5V, R _S =2 kΩ, f=1kHz, F=200Hz			10	dB
		BC182/BC183			4.0	dB
		BC184				dB

*Pulse Test: Pulse Time 300 ns, Duty Cycle=2%

BC182_184Rev_1 201205E

BC182, A, B
 BC183, A, B, C
 BC184, B, C

TO-92
Plastic Package

For Lead Free Parts, Device Part #
 will be Prefixed with "T"

TO-92 Leaded Plastic Package

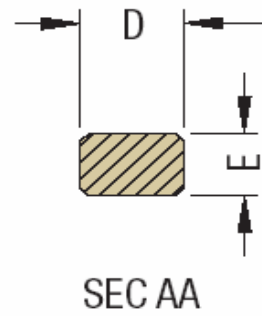
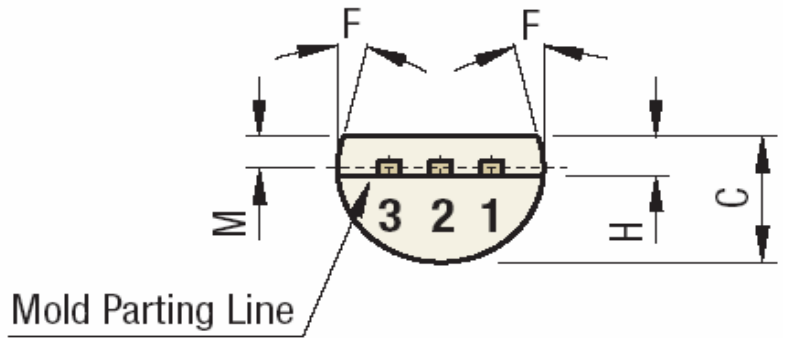
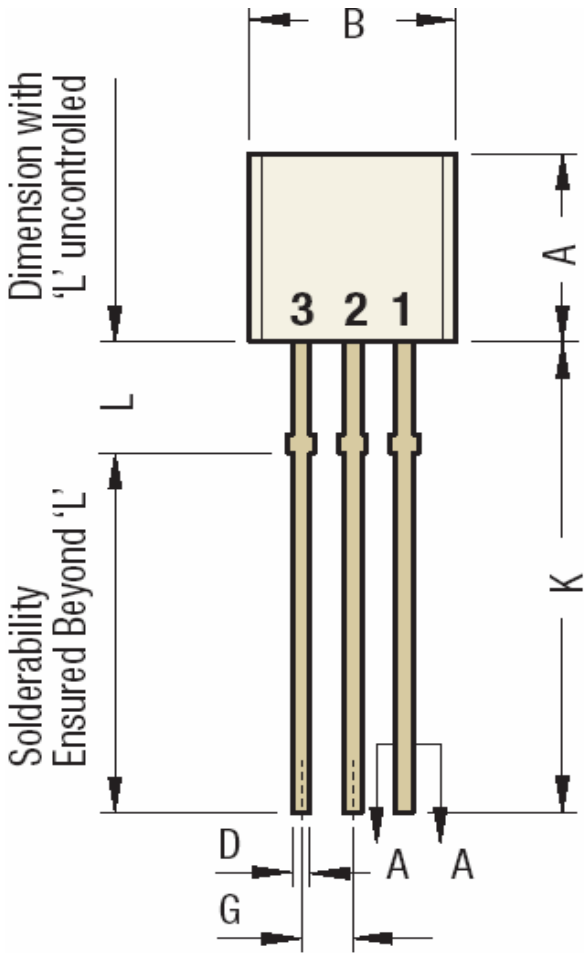

DIM	Min	Max
A	4.32	5.33
B	4.45	5.20
C	3.18	4.19
D	0.40	0.55
E	0.30	0.55
F	5°	

All Dimensions are in mm

DIM	Min	Max
G	1.14	1.40
H	1.20	1.80
K	12.5	
L	1.982	2.082
M	1.03	1.53

Pin 1 Emitter
 Pin 2 Base
 Pin 3 Collector

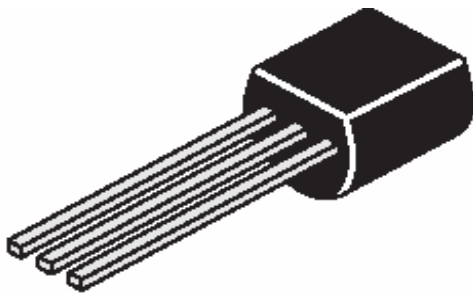

TO-92 Tape and Ammo Packaging

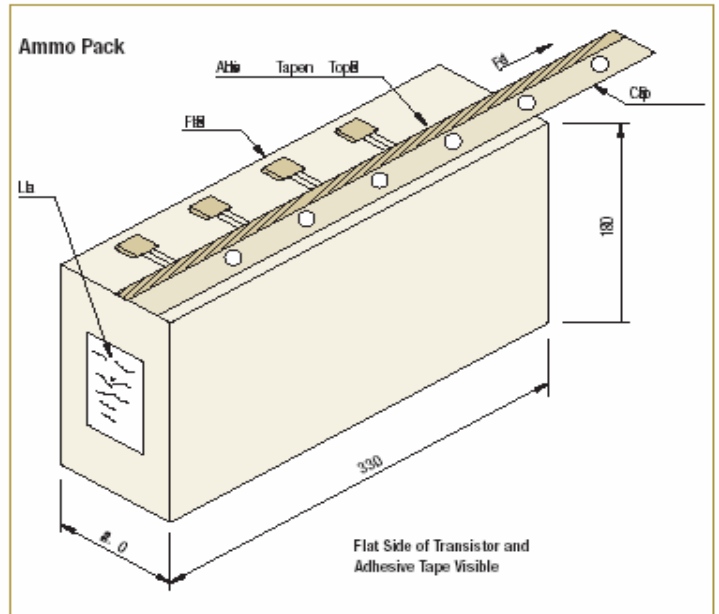
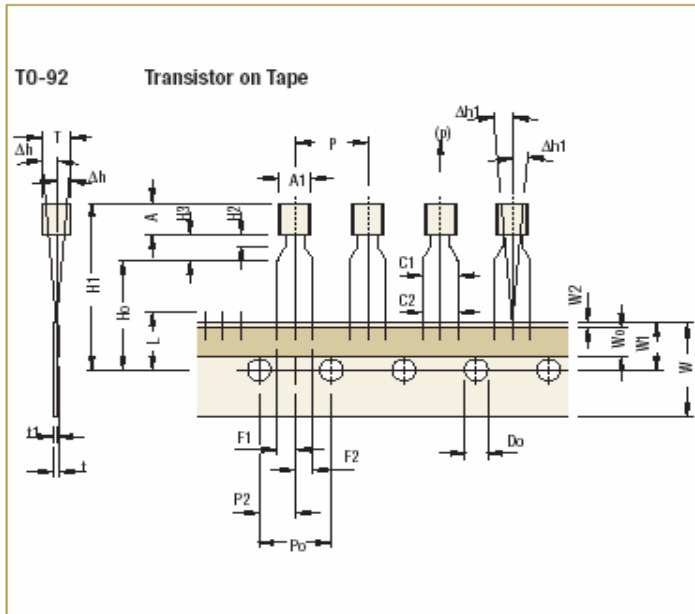

All Dimensions are in mm

Tape Specifications

Item description	Symbol	TO-92			
		Min	Nom	Max	Tol
Body width	A1	4.45		5.20	
Body height	A	4.32		5.33	
Body thickness	T	3.18		4.19	
Pitch of component ^{Cr}	P		12.7		±1.0
Feed hole pitch ^{§1}	Po		12.7		±0.3
Feed hole center to component centre ^{§2}	P2		6.35		±0.4
Comp. alignment, Side view ^{§3}	Dh		0	1.0	
Comp. alignment, Front view ^{§3}	Dh1		0	1.3	
Tape width ^{Cr}	W		18		±0.5
Hold down tape width ^{Cr}	W0		6		±0.2
Hole position	W1		9		+0.7 -0.5
Hold-down tape position	W2	0.0		0.7	
Lead wire clinch height	Ho		16		±0.5
Component height	H1			24.0	
Length of snipped leads	L			11.0	
Feed hole diameter ^{Cr}	Do		4		±0.2
Total tape thickness ^{§4}	t			1.2	
Lead-to-lead distance ^{Cr}	F1, F2	2.4		2.7	
Stand off	H2	0.45		1.45	
Clinch height	H3			3.0	
Lead parallelism ^{Cr}	C1-C2			0.22	
Pull-out force	(p)	6N			

Taping Specification

- Maximum alignment deviation between leads not to be greater than 0.20 mm.
- Maximum non-cumulative variation between tape feed holes shall not exceed 1 mm in 20 pitches.
- Hold down tape not to exceed beyond the edge(s) carrier tape and there shall be no exposure of adhesive.
- No more than 3 consecutive missing components is permitted.
- A tape trailer, having at least three feed holes is required after the last component.
- Splices shall not interfere with the sprocket feed holes.

§1 Cumulative pitch error 1.0 mm/20 pitch.

§2 To be measured at bottom of clinch.

§3 At top of body.

§4 t1 = 0.3 – 0.6 mm

Cr Critical Dimension.

All Dimensions are in mm

BC182, A, B
BC183, A, B, C
BC184, B, C

TO-92

Plastic Package

For Lead Free Parts, Device Part #
will be Prefixed with "T"

Packaging Information

T & A: Tape and Ammo Pack; T & R: Tape and Red; Bulk: Loose in Poly bags; Tube: Tube and Ammo Pack; k: 1.000

Package/Case Type	Packaging Type	Std. Packing		Inner Carton		Outer Carton		
		Qty	Qty	Size L x W x H (cm)	Gross Weight (Kg)	Qty	Size L x W x H (cm)	Gross Weight (Kg)
TO-92	Bulk	1,000	5K	19x19x8	1.10	80K	43x40x35	20.0
	T&A	2,000	2K	32x4.5x20	0.70	40K	43x40x35	15.20

Component Disposal Instructions

1. CDIL Semiconductor Devices are RoHS compliant, customers are requested to please dispose as per prevailing Environmental Legislation of their Country.
2. In Europe, please dispose as per EU Directive 2002/96/EC on Waste Electrical and Electronic Equipment (WEEE).

Customer Notes

Disclaimer

The product information and the selection guides facilitate selection of the CDIL's Semiconductor Device(s) best suited for application in your product(s) as per your requirement. It is recommended that you completely review our Data Sheet(s) so as to confirm that the Device(s) meet functionality parameters for your application. The information furnished in the Data Sheet and on the CDIL Web Site/CD are believed to be accurate and reliable. CDIL however, does not assume responsibility for inaccuracies or incomplete information. Furthermore, CDIL does not assume liability whatsoever, arising out of the application or use of any CDIL product; neither does it convey any license under its patent rights nor rights of others. These products are not designed for use in life saving/support appliances or systems. CDIL customers selling these products (either as individual Semiconductor Devices or incorporated in their end products), in any life saving/support appliances or systems or applications do so at their own risk and CDIL will not be responsible for any damages resulting from such sale(s). CDIL strives for continuous improvement and reserves the right to change the specifications of its products without prior notice.



CDIL is a registered Trademark of
Continental Device India Limited

C-120 Naraina Industrial Area, New Delhi 110 028, India.

Telephone + 91-11-2579 6150, 4141 1112 Fax + 91-11-2579 5290, 4141 1119

BC182_184Rev_1 201205E

email@cdil.com

www.cdilsemi.com

X-ON Electronics

Largest Supplier of Electrical and Electronic Components

Click to view similar products for [Bipolar Transistors - BJT category](#):

Click to view products by [CDIL manufacturer](#):

Other Similar products are found below :

[619691C](#) [MCH4017-TL-H](#) [BC546/116](#) [BC557/116](#) [BSW67A](#) [NTE158](#) [NTE187A](#) [NTE195A](#) [NTE2302](#) [NTE2330](#) [NTE63](#) [C4460](#)
[2SA1419T-TD-H](#) [2SA1721-O\(TE85L,F\)](#) [2SA2126-E](#) [2SB1204S-TL-E](#) [2SD2150T100R](#) [SP000011176](#) [FMMTA92QTA](#) [2N2369ADCSM](#)
[2N5769](#) [2SC2412KT146S](#) [2SC5490A-TL-H](#) [2SD1816S-TL-E](#) [2SD1816T-TL-E](#) [CMXT2207 TR](#) [CPH6501-TL-E](#) [MCH4021-TL-E](#)
[US6T6TR](#) [NJL0281DG](#) [732314D](#) [CMXT3906 TR](#) [CPH3121-TL-E](#) [CPH6021-TL-H](#) [873787E](#) [IMZ2AT108](#) [UMX21NTR](#) [MCH6102-TL-E](#)
[FP204-TL-E](#) [NJL0302DG](#) [2N3583](#) [2SA1434-TB-E](#) [2SC3143-4-TB-E](#) [2SD1621S-TD-E](#) [NTE103](#) [30A02MH-TL-E](#) [NSV40301MZ4T1G](#)
[NTE101](#) [NTE13](#) [NTE15](#)