

## Specification Sheet for Approved

Customer Name:	
Customer Part No.:	
Ceaiya Part No:	CMPI0518 系列
Spec No:	L0518

**【For Customer Approval Only】**

If you Approval, Please Stamp

**【RoHS Compliant Parts】**

Approved By	Checked By	Prepared By
李庆辉	刘志坚	劳水花

## Shenzhen Ceaiya Electronics Co., Ltd.

销售地址 1: 深圳市龙华区观湖街道鹭湖社区观盛二路 5 号捷顺科技中心 B706

工厂地址 2: 广东省东莞清溪镇青滨东路 105 号力合紫荆智能制造中心 10 栋

[Http://www.szceaiya.com](http://www.szceaiya.com)

Tel: 0769-89135516

Fax: 0769-89135519

Specification Sheet for SMD Power Inductor

**【Version of Changed Record】**

<b>Rev.</b>	<b>Effective Date</b>	<b>Changed Contents</b>	<b>Change Reasons</b>	<b>Approved By</b>
A0	2020-12-31	New release	/	Li qing hui

# Specification Sheet for SMD Power Inductor

## 1. Scope

This specification applies to the CMPI0518 Series of wire wound SMD power inductor.

## 2. Product Description and Identification (Part Number)

1) Description:

CMPI0518 series of Wire wound SMD power inductor.

2) Product Identification (Part Number)

CMPI  
①
0518  
②
-
1R0  
③
M  
④

- ① Product Series
- ② Choke Size
- ③ Initial Inductance(L @ 0A):1R0=1.0μH
- ④ Inductance Tolerance:M=L+/-20%

## 3. Electrical Characteristics

- 1) Operating temperature range (individual chip without packing): -40°C ~ +125°C (Including Self-heating)
- 2) Storage temperature range (On PCB): -40°C ~ +125°C

## 4. Shape and Dimensions (Unit:mm)

### MECHANICAL PARAMETERS

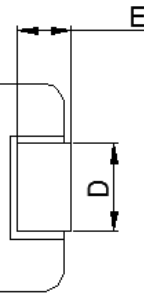
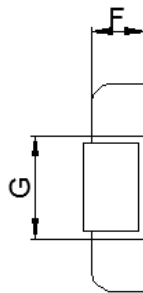
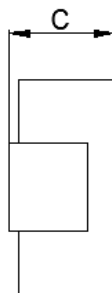
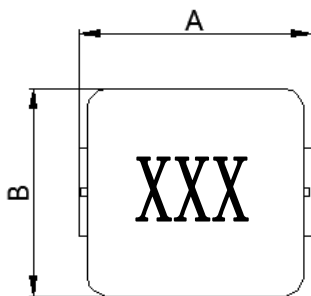

### RECOMMENDED PCB LAYOUT

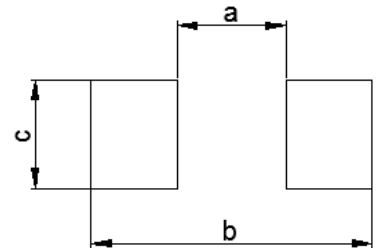

A	B	C	D	E	F	G	a	b	c
5.50	5.20	2.0	2.20	1.20	1.50	2.50	2.20	6.00	2.50
±0.30	±0.20	Max.	±0.30	±0.30	Typ.	Typ.	Typ.	Typ.	Typ.

#### Notes:

1. Marking :Ink Marking
2. Stamping XXX :inductor
3. Dimensions of recommended PCB layout are reference only.
4. Do not route traces nor place vias underneath the inductor. Proper layout is required.

## Specification Sheet for SMD Power Inductor

### 5. Electrical Characteristics

Part Number	L0(uH) ±20%	DCR(mΩ) @25°C		Isat(Amp) Typ.	Irms(Amp) Typ.
		Max.	Typ.		
CMPI0518-R47M	0.47	9.0	7.7	15.5	10.5
CMPI0518-R56M	0.56	10	8.0	15.0	9.5
CMPI0518-R68M	0.68	14	12	12.0	9.0
CMPI0518-1R0M	1.0	17	15	9.0	8.0
CMPI0518-1R5M	1.5	26	21	9.0	7.5
CMPI0518-2R2M	2.2	35	30	6.5	5.0
CMPI0518-3R3M	3.3	58	52	5.0	4.5
CMPI0518-4R7M	4.7	85.0	78	4.0	3.5
CMPI0518-5R6M	5.6	120	107	3.8	2.8
CMPI0518-6R8M	6.8	120	107	3.4	2.8
CMPI0518-100M	10	155	140	3.0	2.5

#### Notes:

1. Initial Inductance (L0) Test Parameters: 100KHz, 1V, Idc=0.0A, +25°C
2. All test data is referenced to 25°C ambient;
3. Rated current: Isat or Irms, whichever is smaller;
4. Irms(A): DC current that causes the temperature rise ( $\Delta T = 40^\circ \text{C}$ ) from 25° C ambient.
5. Isat(A): DC current at which the inductance drops approximate 30% from its value without current;

# Specification Sheet for SMD Power Inductor

## 6. Reliability Test

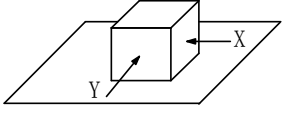
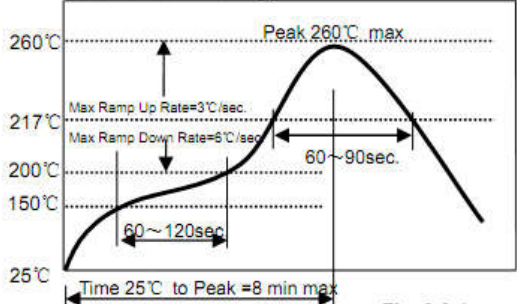
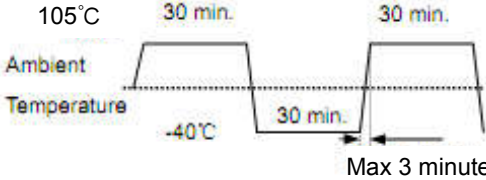
Items	Requirements	Test Methods and Remarks
6.1 Terminal Strength	No removal or split of the termination or other defects shall occur.   Fig.6.1-1	1) Solder the inductor to the testing jig (glass epoxy board shown in Fig.6.1-1) using eutectic solder. Then apply a force in the direction of the arrow. 2) 10N force. 3) Keep time: 5±2s
6.2 High Temperature	1. No visible mechanical damage. 2. Inductance change: Within ±10%	1) Storage Temperature :125+/-5°C 2) Duration : 96 ±4 Hours 3) Recovery : then measured at room ambient temperature after placing 24 hours.
6.3 Low Temperature	1. No visible mechanical damage 2. Inductance change: Within ±10%	1) Temperature and time: -40±5°C 2) Duration: 96±4 hours 3) Recovery : then measured at room ambient temperature after placing 24 hours.
6.4 Vibration test	1. No visible mechanical damage. 2. Inductance change: Within ±10%	1) Frequency range:10Hz~55Hz~10Hz 2) Amplitude:1.5mm p-p 3) Direction:X,Y,Z 4) Time:1 minute/cycle,2hours per axis
6.5 High Temperature Storage Tested	1. No visible mechanical damage. 2. Inductance change: Within ±10%	1) Storage Temperature :60+/-2°C 2) Relative Humidity :90-95% 3) Duration : 96 ±4 Hours 4) Recovery : then measured at room ambient temperature after placing 24 hours.
6.6 Resistance to Soldering Heat	1. No visible mechanical damage. 2. Inductance change: Within ±10%   Fig.6.6-1	1) Re-flowing Profile: Please refer to Fig.6.6-1 2) Test board thickness: 1.0mm 3) Test board material: glass epoxy resin 4) The chip shall be stabilized at normal condition for 1~2 hours before measuring
6.7 Thermal Shock	1. No visible mechanical damage. 2. Inductance change: Within ±10%   Fig.6.7-1	1) Temperature and time: -40±3°C for 30±3 min→105°C for 30±3min, please refer to Fig.6.7-1. 2) Transforming interval: Max, 3 minutes 3) Tested cycle: 100 cycles 4) The chip shall be stabilized at normal condition for 1~2 hours before measuring

# Specification Sheet for SMD Power Inductor

## 7. MATERIAL LIST

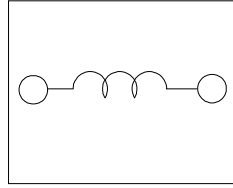
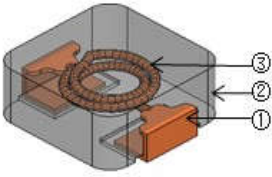

NO.	Part Name	Material
1	Electrode	Cu+Sn plating
2	Core	Metal composite core
3	Coil	Copper wire, 220°C

## 8. PACKAGE INFORMATION-mm

### Peel-off Force

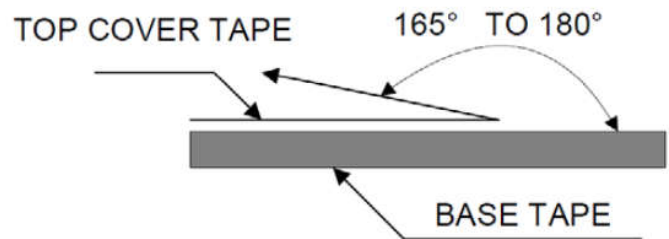
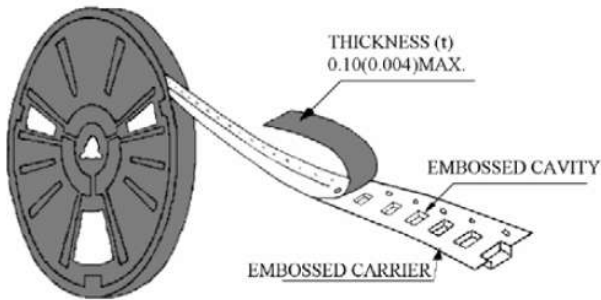

The force for peeling off cover tape is 10 to 70 grams in the arrow direction.

### 8.1 Tape Packaging Dimensions

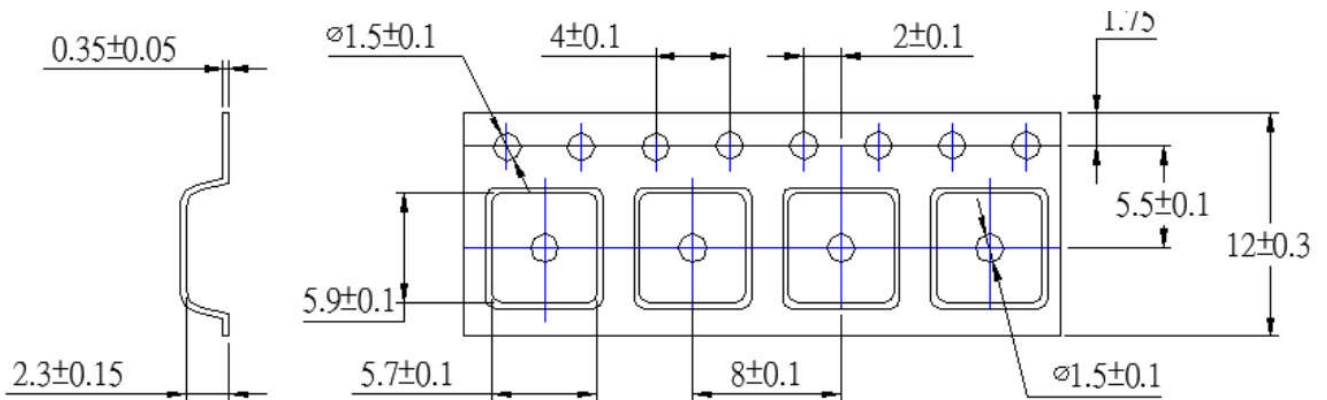

**8.2 Taping dimension and tape direction, Leader ,Trailer, section dimension**

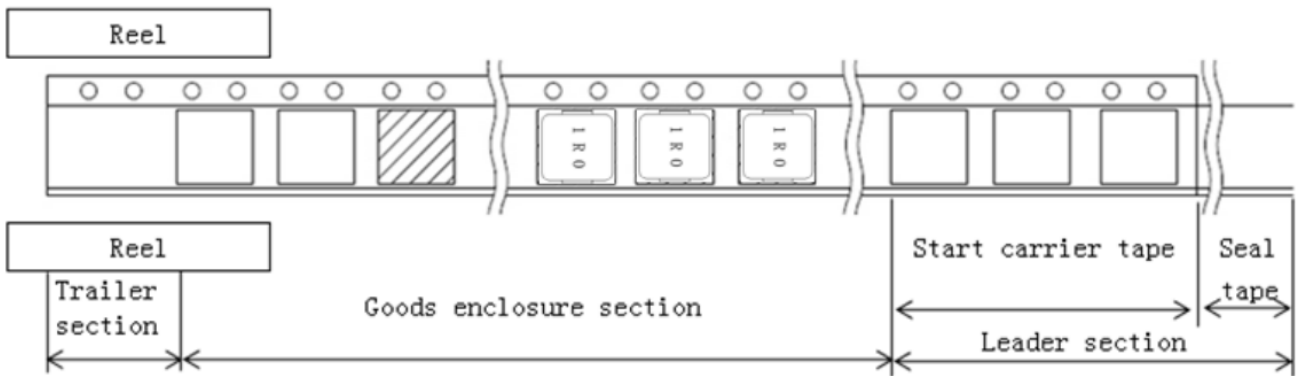

Leader section	Min.400mm
Carrier tape start size	Min.100mm
Trailer section size	Min.160mm

**8.3 Reel Dimensions**

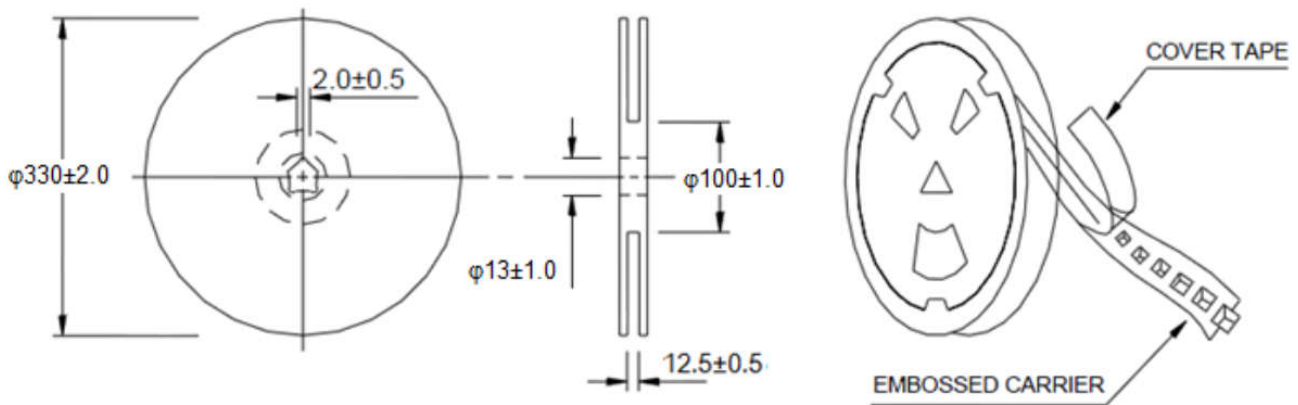

**8.4 Taping Quantity**

2000pieces/Reel,

**8.5 Carton**

Pizza packaging: 3Reel/ Pizza Box

External Packaging :3 Boxes/Carton

## X-ON Electronics

Largest Supplier of Electrical and Electronic Components

*Click to view similar products for [Fixed Inductors](#) category:*

*Click to view products by [Ceaiya](#) manufacturer:*

Other Similar products are found below :

[CR32NP-100KC](#) [CR54NP-470LC](#) [70F224AI](#) [MGDQ4-00004-P](#) [MHQ1005P10NJ](#) [MHQ1005P1N0S](#) [MHQ1005P2N4S](#) [MHQ1005P3N6S](#)  
[MHQ1005P5N1S](#) [MHQ1005P8N2J](#) [PE-53601NL](#) [PE-53602NL](#) [PG0936.113NLT](#) [9220-20](#) [9310-16](#) [PM06-2N7](#) [PM06-39NJ](#) [A01TK](#)  
[1206CS-471XJ](#) [HC2-R47-R](#) [HC8-1R2-R](#) [HCF1305-3R3-R](#) [1206CS-151XG](#) [RCH664NP-140L](#) [RCH664NP-4R7M](#) [RCP1317NP-391L](#)  
[RCR110DNP-331L](#) [DH2280-4R7M](#) [DS1608C-106](#) [B10TJ](#) [B82498B3101J000](#) [ELJ-RE27NJF2](#) [1812CS-153XJ](#) [1812CS-183XJ](#) [1812CS-](#)  
[223XJ](#) [1812LS-104XJ](#) [1812LS-105XJ](#) [1812LS-124XJ](#) [1812LS-154XJ](#) [1812LS-223XJ](#) [1812LS-224XJ](#) [1812LS-563XJ](#) [1812LS-683XJ](#)  
[1812LS-824XJ](#) [NIN-FB101JTR110F](#) [NIN-FB471JTR62F](#) [NIN-FC1R5JTR220F](#) [NIN-HCR15JTRF](#) [NIN-HCR33JTRF](#) [NIN-HDR22JTRF](#)