

Specification Sheet for Approved

Customer Name:	
Customer Part No.:	
Ceaiya Part No:	CMPI0518 系列
Spec No:	L0518

【For Customer Approval Only】

If you Approval, Please Stamp

【RoHS Compliant Parts】

Approved By	Checked By	Prepared By
李庆辉	刘志坚	劳水花

Shenzhen Ceaiya Electronics Co., Ltd.

销售地址 1: 深圳市龙华区观湖街道鹭湖社区观盛二路 5 号捷顺科技中心 B706

工厂地址 2: 广东省东莞清溪镇青滨东路 105 号力合紫荆智能制造中心 10 栋

[Http://www.szceaiya.com](http://www.szceaiya.com)

Tel: 0769-89135516

Fax: 0769-89135519

Specification Sheet for SMD Power Inductor

1. Scope

This specification applies to the CMPI0518 Series of wire wound SMD power inductor.

2. Product Description and Identification (Part Number)

1) Description:

CMPI0518 series of Wire wound SMD power inductor.

2) Product Identification (Part Number)

CMPI
①
0518
②
-
1R0
③
M
④

- ① Product Series
- ② Choke Size
- ③ Initial Inductance(L @ 0A):1R0=1.0μH
- ④ Inductance Tolerance:M=L+/-20%

3. Electrical Characteristics

- 1) Operating temperature range (individual chip without packing): -40°C ~ +125°C (Including Self-heating)
- 2) Storage temperature range (On PCB): -40°C ~ +125°C

4. Shape and Dimensions (Unit:mm)

MECHANICAL PARAMETERS

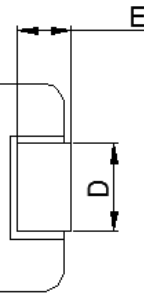
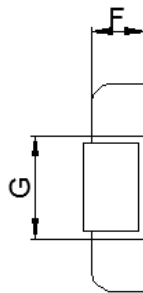
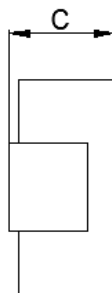
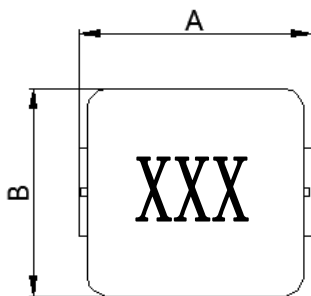

RECOMMENDED PCB LAYOUT

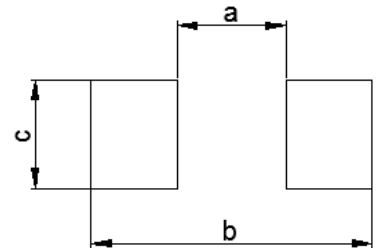

A	B	C	D	E	F	G	a	b	c
5.50	5.20	2.0	2.20	1.20	1.50	2.50	2.20	6.00	2.50
±0.30	±0.20	Max.	±0.30	±0.30	Typ.	Typ.	Typ.	Typ.	Typ.

Notes:

1. Marking :Ink Marking
2. Stamping XXX :inductor
3. Dimensions of recommended PCB layout are reference only.
4. Do not route traces nor place vias underneath the inductor. Proper layout is required.

Specification Sheet for SMD Power Inductor

5. Electrical Characteristics

Part Number	L0(uH) ±20%	DCR(mΩ) @25°C		Isat(Amp) Typ.	Irms(Amp) Typ.
		Max.	Typ.		
CMPI0518-R47M	0.47	9.0	7.7	15.5	10.5
CMPI0518-R56M	0.56	10	8.0	15.0	9.5
CMPI0518-R68M	0.68	14	12	12.0	9.0
CMPI0518-1R0M	1.0	17	15	9.0	8.0
CMPI0518-1R5M	1.5	26	21	9.0	7.5
CMPI0518-2R2M	2.2	35	30	6.5	5.0
CMPI0518-3R3M	3.3	58	52	5.0	4.5
CMPI0518-4R7M	4.7	85.0	78	4.0	3.5
CMPI0518-5R6M	5.6	120	107	3.8	2.8
CMPI0518-6R8M	6.8	120	107	3.4	2.8
CMPI0518-100M	10	155	140	3.0	2.5

Notes:

1. Initial Inductance (L0) Test Parameters:100KHz,1V,Idc=0.0A,+25°C
2. All test data is referenced to 25°C ambient;
3. Rated current: Isat or Irms, whichever is smaller;
4. Irms(A): DC current that causes the temperature rise ($\Delta T = 40^{\circ} C$) from 25° C ambient.
5. Isat(A): DC current at which the inductance drops approximate 30% from its value without current;

Specification Sheet for SMD Power Inductor

6. Reliability Test

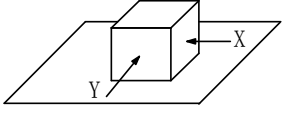
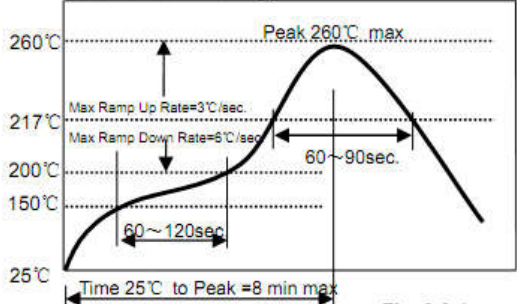
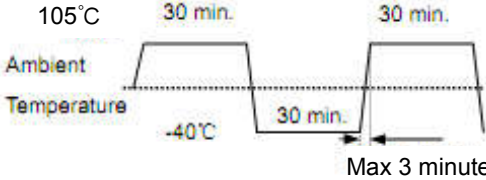
Items	Requirements	Test Methods and Remarks
6.1 Terminal Strength	No removal or split of the termination or other defects shall occur.  Fig.6.1-1	1) Solder the inductor to the testing jig (glass epoxy board shown in Fig.6.1-1) using eutectic solder. Then apply a force in the direction of the arrow. 2) 10N force. 3) Keep time: 5±2s
6.2 High Temperature	1. No visible mechanical damage. 2. Inductance change: Within ±10%	1) Storage Temperature :125+/-5°C 2) Duration : 96 ±4 Hours 3) Recovery : then measured at room ambient temperature after placing 24 hours.
6.3 Low Temperature	1. No visible mechanical damage 2. Inductance change: Within ±10%	1) Temperature and time: -40±5°C 2) Duration: 96±4 hours 3) Recovery : then measured at room ambient temperature after placing 24 hours.
6.4 Vibration test	1. No visible mechanical damage. 2. Inductance change: Within ±10%	1) Frequency range:10Hz~55Hz~10Hz 2) Amplitude:1.5mm p-p 3) Direction:X,Y,Z 4) Time:1 minute/cycle,2hours per axis
6.5 High Temperature Storage Tested	1. No visible mechanical damage. 2. Inductance change: Within ±10%	1) Storage Temperature :60+/-2°C 2) Relative Humidity :90-95% 3) Duration : 96 ±4 Hours 4) Recovery : then measured at room ambient temperature after placing 24 hours.
6.6 Resistance to Soldering Heat	1. No visible mechanical damage. 2. Inductance change: Within ±10%  Fig.6.6-1	1) Re-flowing Profile: Please refer to Fig.6.6-1 2) Test board thickness: 1.0mm 3) Test board material: glass epoxy resin 4) The chip shall be stabilized at normal condition for 1~2 hours before measuring
6.7 Thermal Shock	1. No visible mechanical damage. 2. Inductance change: Within ±10%  Fig.6.7-1	1) Temperature and time: -40±3°C for 30±3 min→105°C for 30±3min, please refer to Fig.6.7-1. 2) Transforming interval: Max, 3 minutes 3) Tested cycle: 100 cycles 4) The chip shall be stabilized at normal condition for 1~2 hours before measuring

Specification Sheet for SMD Power Inductor

7. MATERIAL LIST

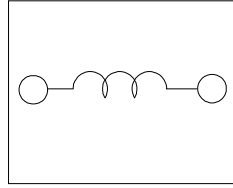
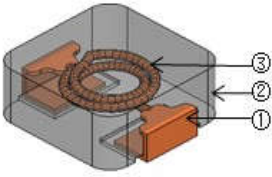

NO.	Part Name	Material
1	Electrode	Cu+Sn plating
2	Core	Metal composite core
3	Coil	Copper wire, 220°C

8. PACKAGE INFORMATION-mm

Peel-off Force

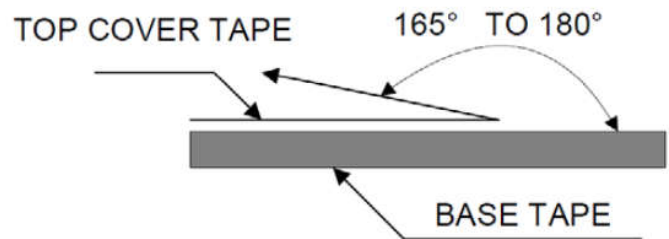
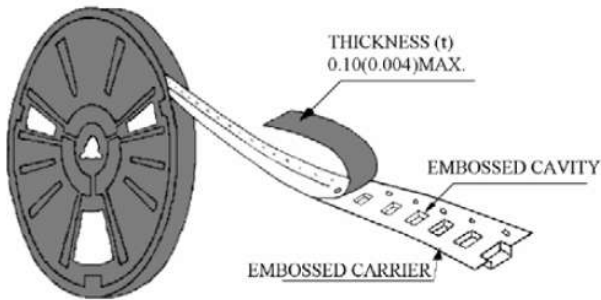

The force for peeling off cover tape is 10 to 70 grams in the arrow direction.

8.1 Tape Packaging Dimensions

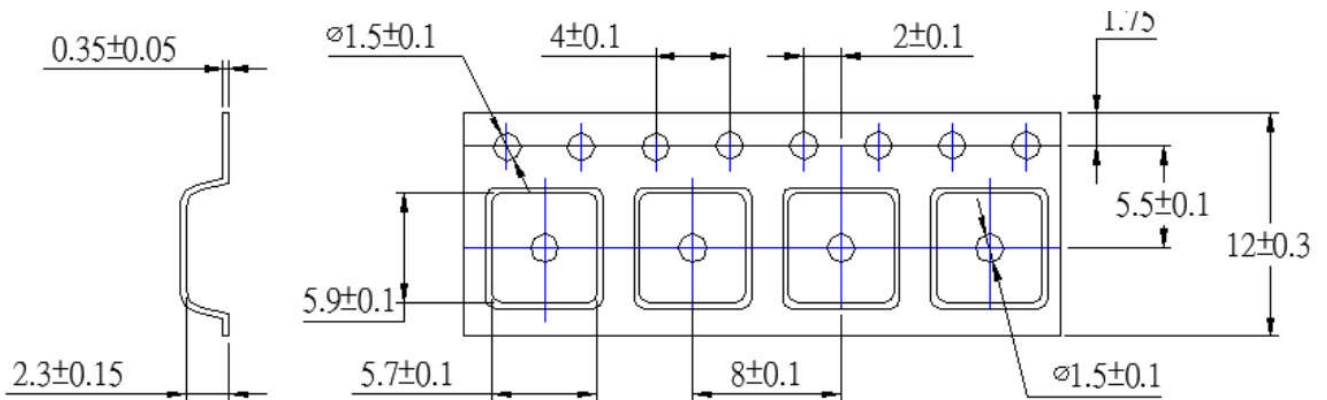

8.2 Taping dimension and tape direction, Leader ,Trailer, section dimension

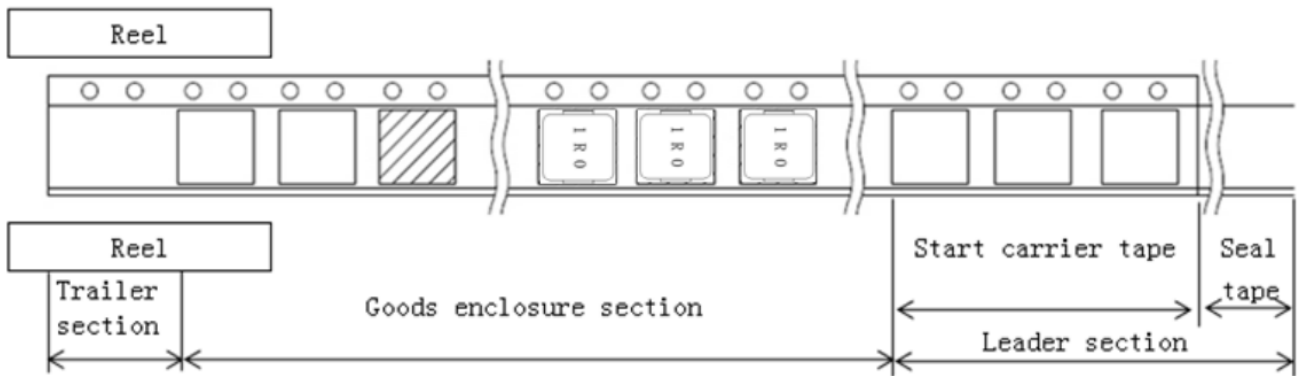

Leader section	Min.400mm
Carrier tape start size	Min.100mm
Trailer section size	Min.160mm

8.3 Reel Dimensions

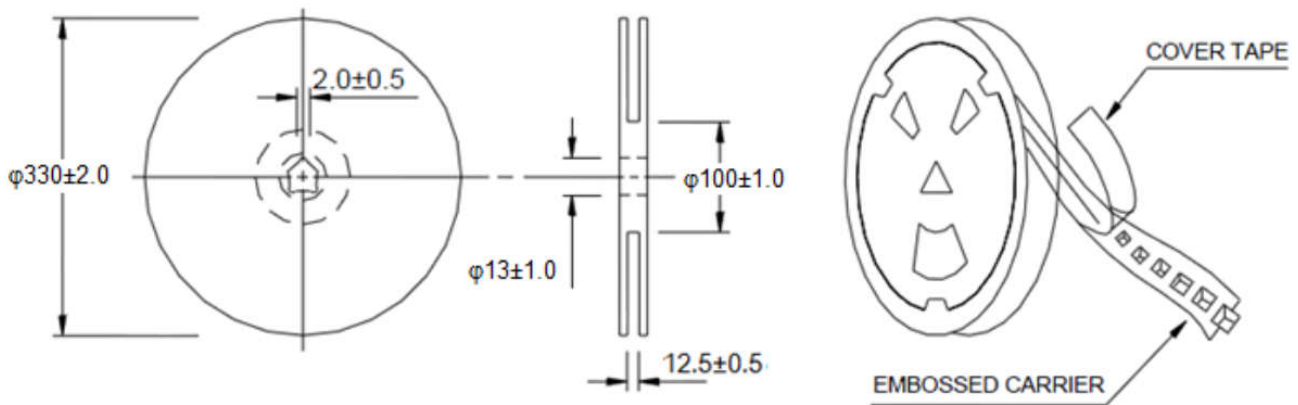

8.4 Taping Quantity

2000pieces/Reel,

8.5 Carton

Pizza packaging: 3Reel/ Pizza Box

External Packaging :3 Boxes/Carton

X-ON Electronics

Largest Supplier of Electrical and Electronic Components

Click to view similar products for [Fixed Inductors](#) category:

Click to view products by [Ceaiya](#) manufacturer:

Other Similar products are found below :

[CR32NP-100KC](#) [CR54NP-470LC](#) [70F224AI](#) [MGDQ4-00004-P](#) [MHQ1005P10NJ](#) [MHQ1005P1N0S](#) [MHQ1005P2N4S](#) [MHQ1005P3N6S](#)
[MHQ1005P5N1S](#) [MHQ1005P8N2J](#) [PE-53601NL](#) [PE-53602NL](#) [PG0936.113NLT](#) [9220-20](#) [9310-16](#) [PM06-2N7](#) [PM06-39NJ](#) [A01TK](#)
[1206CS-471XJ](#) [HC2-R47-R](#) [HC8-1R2-R](#) [HCF1305-3R3-R](#) [1206CS-151XG](#) [RCH664NP-140L](#) [RCH664NP-4R7M](#) [RCP1317NP-391L](#)
[RCR110DNP-331L](#) [DH2280-4R7M](#) [DS1608C-106](#) [B10TJ](#) [B82498B3101J000](#) [ELJ-RE27NJF2](#) [1812CS-153XJ](#) [1812CS-183XJ](#) [1812CS-](#)
[223XJ](#) [1812LS-104XJ](#) [1812LS-105XJ](#) [1812LS-124XJ](#) [1812LS-154XJ](#) [1812LS-223XJ](#) [1812LS-224XJ](#) [1812LS-563XJ](#) [1812LS-683XJ](#)
[1812LS-824XJ](#) [NIN-FB101JTR110F](#) [NIN-FB471JTR62F](#) [NIN-FC1R5JTR220F](#) [NIN-HCR15JTRF](#) [NIN-HCR33JTRF](#) [NIN-HDR22JTRF](#)