

电感、变压器一流供应商
Inductors, transformers first-class suppliers

深圳市柯爱亚电子有限公司
SHENZHEN CEAIYA ELECTRONICS CO.,LTD.

淮安市柯爱亚电子有限公司
HUAIAN CEAIYA ELECTRONICS CO.,LTD.

Add: 深圳市观兰镇环观中路66号

Tel: 0755-2799 3000 2799 3488

Fax: 0755-2799 3067

Http://www.ceaiya.com

E-mail:ceaiya@vip.163.com

ceaiya
柯爱亚

2014
www.ceaiya.com

RoHS
Compliance

深圳市柯爱亚电子有限公司
SHENZHEN CEAIYA ELECTRONICS CO.,LTD.

**PRODUCT
CATALOG**

电感、变压器一流供应商
Inductors, transformers first-class suppliers

www.ceaiya.com



2014
PRODUCT
CATALOG

深圳市柯爱亚电子有限公司

SHENZHEN CEAIYA ELECTRONICS CO.,LTD.

淮安市柯爱亚电子有限公司

HUAIAN CEAIYA ELECTRONICS CO.,LTD.

Add: 深圳市观兰镇环观中路66号

Tel: 0755-2799 3000 2799 3488

Fax: 0755-2799 3067

Http://www.ceaiya.com

E-mail:ceaiya@vip.163.com



深圳市柯爱亚电子有限公司
SHENZHEN CEAIYA ELECTRONICS CO.,LTD.

电感、变压器一流供应商
Inductors, transformers first-class suppliers

www.ceaiya.com



2014 产·品·目·录

P R O D U C T C A T A L O G

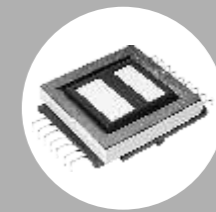

深圳市柯爱亚电子有限公司
SHENZHEN CEAIYA ELECTRONICS CO.,LTD.

淮安市柯爱亚电子有限公司
HUAIAN CEAIYA ELECTRONICS CO.,LTD.

Add: 深圳市观兰镇环观中路66号

Tel: 0755-2799 3000 2799 3488

Fax: 0755-2799 3067

Http://www.ceaiya.com

E-mail: ceaiya@vip.163.com



深圳市柯爱亚电子有限公司
SHENZHEN CEAIYA ELECTRONICS CO.,LTD.



电感、变压器一流供应商
Inductors, transformers first-class suppliers

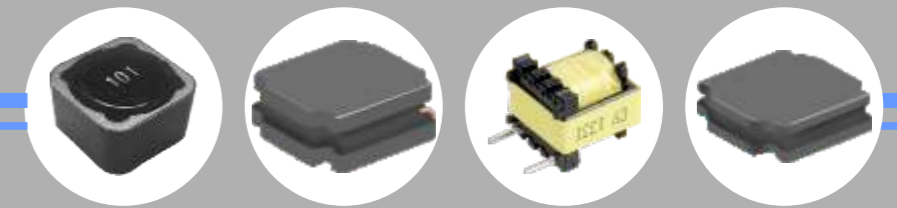

2014产品目录 PRODUCT CATALOG

www.ceaiya.com

深圳市柯爱亚电子有限公司

SHENZHEN CEAIYA ELECTRONICS CO.,LTD.

淮安市柯爱亚电子有限公司

HUAIAN CEAIYA ELECTRONICS CO.,LTD.

Add: 深圳市观兰镇环观中路66号

Tel: 0755-2799 3000 2799 3488

Fax: 0755-2799 3067

Http://www.ceaiya.com

E-mail:ceaiya@vip.163.com



深圳市柯爱亚电子有限公司
SHENZHEN CEAIYA ELECTRONICS CO.,LTD.

公司简介 Company Introduction

1998年深圳市柯爱亚电子有限公司成立，专业从事功率电感，变压器研发、生产；2004年淮安市柯爱亚电子有限公司成立，目前公司厂房15000平米，员工1500人（其中工程技术人员100余人），月产量40KK,年营业额2亿。

2010年起，我们潜心于自动化技术的进步，投入千万元，形成十条功率电感、变压器自动化生产线，效率提高50%以上。付出总有回报，大规模的制造能力，稳定的品质水准，领先的专业技术，我们成为国内外一批著名企业(HISENSE,CHANGHONG,SKYWORTH,TCL,OPPO,FOXCONN)的合作伙伴。

坚持改进，创新的工作方法，坚持诚实，永续的经营思想，坚持追求更好的服务理念。

柯爱亚人，秉着工作付出不亚于任何人的生活态度，努力争取成为国际大厂供应链中的一员。

Shenzhen Keaiya Electronics Co., Ltd. was established in 1998. It is a professional company engaged in developing and manufacturing power inductors, transformers, as well as high current molding inductors. In the year of 2004, Huaian Keaiya Electronics Co., Ltd. was founded. Until now it covers 15000 square meters and has staff of 1500 people, including over 100 R & D engineers and technicians, with a monthly output reached up to 40 million and a annual turnover of 200 million.

Since 2010, we have made good efforts in automated manufacturing. Having an investment of nearly 10 million, we have developed ten automated production lines of power inductors and transformers, which increases the efficiency by 50 %. What comes around goes around. Relying on large-scale automated manufacturing, high quality and advanced technology, we are honored to be partner with the famous companies at household appliance and broad, such as HISENSE, CHANGHONG, SKYWORTH, TCL, OPPO and FOXCONN.

Insisting on innovational working way and sincere business idea, we are always pursuing better services for our customers. Never lagging behind others, all our members of Keaiya are working hard, in the hope of being a member of international supply chain.

Contents

| | |
|--|-------|
| ■ Coils /Inductors | |
| ● SMD Power Inductors | |
| CR Series | |
| CR25Series..... | 1-2 |
| CR30Series..... | 3-4 |
| CR40Series..... | 5-7 |
| CR50Series..... | 8-9 |
| CR60Series..... | 10-11 |
| CR80Series..... | 12 |
| SHI Series | |
| SHI0402..... | 13-14 |
| SHI0515..... | 13-14 |
| SHI0603..... | 13-14 |
| CD Series | |
| CD43 Series..... | 15-16 |
| CD54 Series..... | 17 |
| CD75 Series..... | 18 |
| CD105 Series..... | 19-20 |
| CDH Series | |
| CDH6B Series..... | 21-22 |
| CDH8B Series..... | 23-24 |
| CDH103R Series..... | 25-26 |
| CDH104R Series..... | 26 |
| CDH105R Series..... | 27 |
| CDH12 Series..... | 28-30 |
| BF Series | |
| BF1608..... | 31-32 |
| BF3316..... | 31-32 |
| BF5022..... | 31-32 |
| B Series | |
| B1608..... | 33-34 |
| B3316..... | 33-34 |
| B3340..... | 35-36 |
| B5022..... | 35-36 |
| ● SMD Wire Wound Ferrite Common Mode Choke | |
| CM Series..... | 37 |
| PCM Series..... | 38 |
| TCM Series..... | 38 |
| ● SMD Wire Wound Chip Ceramic Inductors | |
| WIC1005 Series..... | 44 |
| WIC1608 Series..... | 44-46 |
| WIC2012 Series..... | 46 |
| WIC2520 Series..... | 47 |
| ● SMD Wire Wound Chip Ferrite Inductors | |
| WIF2520 Series..... | 49 |
| WIF3225 Series..... | 49-50 |
| WIF4532 Series..... | 50 |
| ■ Coils /Transformers | |
| ● EE Series | |
| EE10 | 50 |
| EE13..... | 51 |

Wound Ferrite SMD Inductor for Power Circuit-----CR Series

Operating Temp. : -40°C~125°C(including self-heating)



Feature

- Metallization on ferrite core result in excellent thermal shock.
- Magnetic-resin shielded construction reduce buzz noise to ultra-low levels
- Closed magnetic circuit design reduces leakage flux and excellent for EMI

Application

- Smart phone, MID, table terminal , HDDs ,DSCs , VRMs
- Set Top Boxes, Mobile Power
- Portable gaming device , navigation systems

Production identification

CR 252012 6R8 M T

① ② ③ ④ ⑤

① CR
Series Name

③ Inductance value
6R8 -----> 6.8uH
100----->10uH

④ Inductance Tolerance
K-----> ± 10%
M-----> ± 20%
N-----> ± 30%

⑤ Packing Type
T---->Tape Carrier Package

② External Dimensions (L x W x H.) [Unit: mm]

| | |
|--------|------------------|
| 252010 | 2.5 × 2.0 × 1.0 |
| 252012 | 2.5 × 2.0 × 1.2 |
| 3010 | 3.0 × 3.0 × 1.0 |
| 3012 | 3.0 × 3.0 × 1.2 |
| 3015 | 3.0 × 3.0 × 1.5 |
| 4012 | 4.0 × 4.0 × 1.35 |
| 4015 | 4.0 × 4.0 × 1.65 |
| 4018 | 4.0 × 4.0 × 1.85 |
| 4020 | 4.0 × 4.0 × 2.0 |
| 4030 | 4.0 × 4.0 × 3.0 |
| 5015 | 5.0 × 5.0 × 1.5 |
| 5020 | 5.0 × 5.0 × 2.0 |
| 5030 | 5.0 × 5.0 × 3.0 |
| 5040 | 5.0 × 5.0 × 4.0 |
| 6015 | 6.0 × 6.0 × 1.5 |
| 6020 | 6.0 × 6.0 × 2.0 |
| 6028 | 6.0 × 6.0 × 3.0 |
| 6045 | 6.0 × 6.0 × 4.5 |
| 8040 | 8.0 × 8.0 × 4.2 |

※CR2 Series

Shape and Dimension (Unit:mm)

Recommended Land Pattern

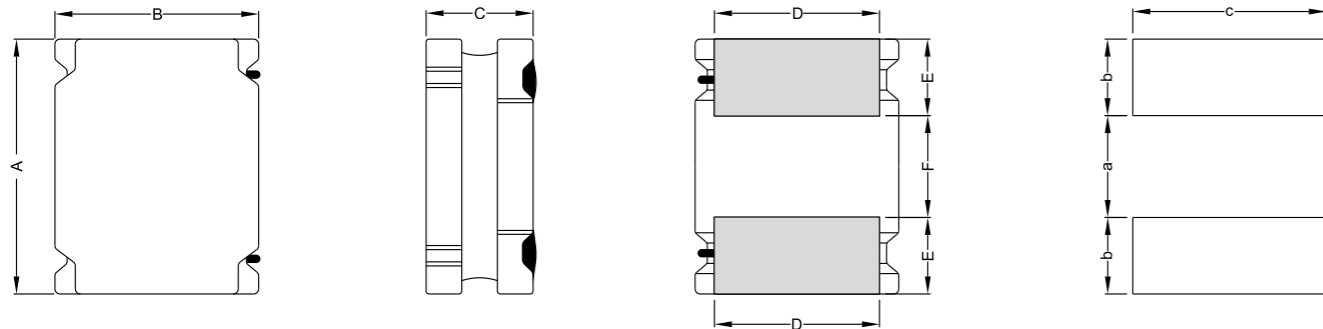

| Series | A | B | C | D | E | F | a Typ. | b Typ. | c Typ. |
|----------|-----------|-----------|---------|-----------|------------|------------|--------|--------|--------|
| CR252010 | 2.5 ± 0.1 | 2.0 ± 0.1 | 1.0Max. | 1.5 ± 0.2 | 0.80 ± 0.2 | 0.80 ± 0.2 | 0.80 | 0.85 | 2.0 |
| CR252012 | 2.5 ± 0.1 | 2.0 ± 0.1 | 1.2Max. | 1.5 ± 0.2 | 0.80 ± 0.2 | 0.80 ± 0.2 | 0.80 | 0.85 | 2.0 |

Wound Ferrite SMD Inductor for Power Circuit-----CR Series

Operating Temp. : -40°C~125°C(including self-heating)

Electronic Characteristics List

| Part Number | Inductance (uH) | Tolerance (±%) | DCR(mΩ) ±25% | Isat (A) | | Irise(A) | Test Condition |
|---------------|-----------------|----------------|--------------|----------|------|----------|----------------|
| | | | | Max | Typ | | |
| CR252010-1R0N | 1.0 | 30 | 90 | 1.85 | 2.20 | 1.65 | 100KHz /0.25V |
| CR252010-1R5M | 1.5 | 20 | 152 | 1.80 | 2.10 | 1.30 | 100KHz /0.25V |
| CR252010-2R2M | 2.2 | 20 | 174 | 1.20 | 1.60 | 1.20 | 100KHz /0.25V |
| CR252010-3R3M | 3.3 | 20 | 273 | 1.05 | 1.30 | 0.90 | 100KHz /0.25V |
| CR252010-4R7M | 4.7 | 20 | 469 | 0.95 | 1.15 | 0.70 | 100KHz /0.25V |
| CR252010-6R8M | 6.8 | 20 | 747 | 0.78 | 0.92 | 0.59 | 100KHz /0.25V |
| CR252010-100M | 10 | 20 | 910 | 0.65 | 0.78 | 0.50 | 100KHz /0.25V |
| CR252012-1R0N | 1.0 | 30 | 85 | 2.68 | 3.00 | 1.58 | 100KHz /0.25V |
| CR252012-1R5M | 1.5 | 20 | 113 | 2.24 | 2.51 | 1.40 | 100KHz /0.25V |
| CR252012-2R2M | 2.2 | 20 | 165 | 1.85 | 2.07 | 1.15 | 100KHz /0.25V |
| CR252012-3R3M | 3.3 | 20 | 200 | 1.61 | 1.80 | 1.04 | 100KHz /0.25V |
| CR252012-4R7M | 4.7 | 20 | 315 | 1.18 | 1.32 | 0.84 | 100KHz /0.25V |
| CR252012-6R8M | 6.8 | 20 | 447 | 0.98 | 1.10 | 0.69 | 100KHz /0.25V |
| CR252012-8R2M | 8.2 | 20 | 506 | 0.92 | 1.00 | 0.65 | 100KHz /0.25V |
| CR252012-100M | 10 | 20 | 575 | 0.88 | 0.97 | 0.62 | 100KHz /0.25V |

Isat (A):

The saturation current value (Isat) is the DC current value having inductance decrease down to 30%(at 20°C).

Irise (A)

The temperature rise current value (Irise) is the DC current having temperature increase up to 40°C(at 20°C).

Wound Ferrite SMD Inductor for Power Circuit-----CR Series

Operating Temp. : -40°C~125°C(including self-heating)



※CR3 Series

Shape and Dimension (Unit:mm)

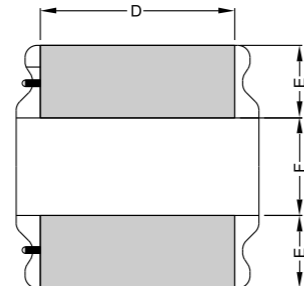
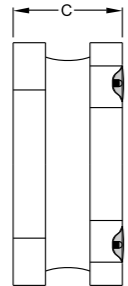
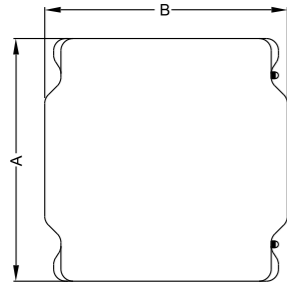

Recommended Land Pattern

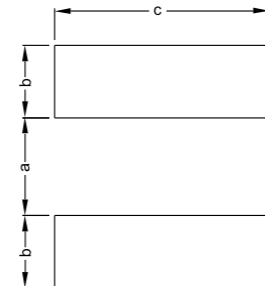

| Series | A | B | C | D | E | F | a Typ. | b Typ. | c Typ. |
|--------|---------|---------|---------|---------|---------|---------|--------|--------|--------|
| Cr3010 | 3.0±0.2 | 3.0±0.2 | 1.0Max | 2.5±0.2 | 2.5±0.2 | 1.5±0.2 | 2.7 | 1.5 | 0.8 |
| CR3012 | 3.0±0.2 | 3.0±0.2 | 1.2Max | 2.5±0.2 | 2.5±0.2 | 1.5±0.2 | 2.7 | 1.5 | 0.8 |
| CR3015 | 3.0±0.2 | 3.0±0.2 | 1.5Max | 2.5±0.2 | 2.5±0.2 | 1.5±0.2 | 2.7 | 1.5 | 0.8 |
| CR3018 | 3.0±0.2 | 3.0±0.2 | 1.85Max | 2.5±0.2 | 2.5±0.2 | 1.5±0.2 | 2.7 | 1.5 | 0.8 |
| CR3020 | 3.0±0.2 | 3.0±0.2 | 2.00Max | 2.5±0.2 | 2.5±0.2 | 1.5±0.2 | 2.7 | 1.5 | 0.8 |
| CR3021 | 3.0±0.2 | 3.0±0.2 | 2.35Max | 2.5±0.2 | 2.5±0.2 | 1.5±0.2 | 2.7 | 1.5 | 0.8 |

Electronic Characteristics List

| Part Number | Inductance (uH) | Tolerance (±%) | DCR(mΩ) ±25% | Isat (A) | Irise(A) | Test Condition |
|-------------|-----------------|----------------|--------------|----------|----------|----------------|
| CR3010-1R0N | 1.0 | 30 | 65 | 1.40 | 1.45 | 100KHz /0.25V |
| CR3010-1R2N | 1.2 | 30 | 65 | 1.25 | 1.45 | 100KHz /0.25V |
| CR3010-1R5N | 1.5 | 30 | 80 | 1.27 | 1.30 | 100KHz /0.25V |
| CR3010-2R2N | 2.2 | 30 | 110 | 1.15 | 1.09 | 100KHz /0.25V |
| CR3010-2R7N | 2.7 | 30 | 130 | 1.00 | 1.02 | 100KHz /0.25V |
| CR3010-3R3N | 3.3 | 30 | 145 | 0.97 | 0.96 | 100KHz /0.25V |
| CR3010-3R6M | 3.6 | 20 | 165 | 0.95 | 0.90 | 100KHz /0.25V |
| CR3010-4R7M | 4.7 | 20 | 225 | 0.75 | 0.77 | 100KHz /0.25V |
| CR3010-6R8M | 6.8 | 20 | 305 | 0.55 | 0.66 | 100KHz /0.25V |
| CR3010-100M | 10 | 20 | 400 | 0.55 | 0.58 | 100KHz /0.25V |
| CR3010-120M | 12 | 20 | 505 | 0.43 | 0.52 | 100KHz /0.25V |
| CR3010-150M | 15 | 20 | 610 | 0.42 | 0.47 | 100KHz /0.25V |
| CR3010-220M | 22 | 20 | 930 | 0.35 | 0.38 | 100KHz /0.25V |
| CR3012-R47N | 0.47 | 30 | 33 | 2.20 | 2.20 | 100KHz /0.25V |
| CR3012-R82N | 0.82 | 30 | 40 | 2.05 | 2.10 | 100KHz /0.25V |
| CR3012-1R0N | 1.0 | 30 | 48 | 1.90 | 2.00 | 100KHz /0.25V |
| CR3012-1R5N | 1.5 | 30 | 55 | 1.62 | 1.85 | 100KHz /0.25V |
| CR3012-2R2M | 2.2 | 20 | 75 | 1.20 | 1.55 | 100KHz /0.25V |
| CR3012-3R3M | 3.3 | 20 | 100 | 1.05 | 1.35 | 100KHz /0.25V |
| CR3012-4R7M | 4.7 | 20 | 120 | 0.90 | 1.25 | 100KHz /0.25V |
| CR3012-6R8M | 6.8 | 20 | 190 | 0.75 | 1.00 | 100KHz /0.25V |
| CR3012-100M | 10 | 20 | 265 | 0.60 | 0.89 | 100KHz /0.25V |
| CR3012-150M | 15 | 20 | 430 | 0.45 | 0.72 | 100KHz /0.25V |
| CR3012-220M | 22 | 20 | 630 | 0.42 | 0.55 | 100KHz /0.25V |

Wound Ferrite SMD Inductor for Power Circuit-----CR Series

Operating Temp. : -40°C~125°C(including self-heating)

| Part Number | Inductance (uH) | Tolerance (±%) | DCR(mΩ) ±25% | Isat (A) | Irise(A) | Test Condition |
|-------------|-----------------|----------------|--------------|----------|----------|----------------|
| CR3015-1R0N | 1.0 | 30 | 37 | 2.32 | 2.10 | 100KHz /0.25V |
| CR3015-1R5N | 1.5 | 30 | 50 | 2.00 | 1.70 | 100KHz /0.25V |
| CR3015-2R2N | 2.2 | 30 | 60 | 1.60 | 1.60 | 100KHz /0.25V |
| CR3015-3R3M | 3.3 | 20 | 80 | 1.32 | 1.36 | 100KHz /0.25V |
| CR3015-4R7M | 4.7 | 20 | 125 | 1.10 | 1.09 | 100KHz /0.25V |
| CR3015-6R8M | 6.8 | 20 | 200 | 0.85 | 0.85 | 100KHz /0.25V |
| CR3015-100M | 10 | 20 | 250 | 0.72 | 0.77 | 100KHz /0.25V |
| CR3015-220M | 22 | 20 | 460 | 0.52 | 0.57 | 100KHz /0.25V |

Isat (A):

The saturation current value (Isat) is the DC current value having inductance decrease down to 30%(at 20°C).

Irise(A)

The temperature rise current value (Irise) is the DC current having temperature increase up to 40°C(at 20°C)

Remarks:

With the series of other highly products have been improved

同系列其他高度的产品已在完善中

Wound Ferrite SMD Inductor for Power Circuit-----CR Series

Operating Temp. : -40°C~125°C(including self-heating)



※CR4 Series

Shape and Dimension (Unit:mm)

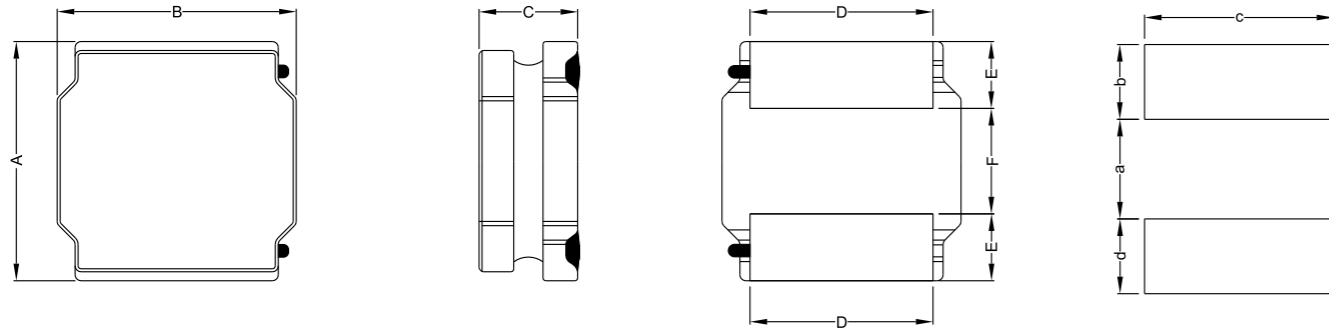

Recommended Land Pattern

| Series | A | B | C | D | E | F | a Typ. | b Typ. | c Typ. |
|--------|---------|---------|---------|---------|----------|---------|--------|--------|--------|
| CR4010 | 4.0±0.2 | 4.0±0.2 | 1.0Max | 3.3±0.2 | 0.95±0.2 | 2.1±0.2 | 3.7 | 1.9 | 1.1 |
| CR4012 | 4.0±0.2 | 4.0±0.2 | 1.2Max | 3.3±0.2 | 0.95±0.2 | 2.1±0.2 | 3.7 | 1.9 | 1.1 |
| CR4015 | 4.0±0.2 | 4.0±0.2 | 1.65Max | 3.3±0.2 | 0.95±0.2 | 2.1±0.2 | 3.7 | 1.9 | 1.1 |
| CR4018 | 4.0±0.2 | 4.0±0.2 | 1.8Max | 3.3±0.2 | 0.95±0.2 | 2.1±0.2 | 3.7 | 1.9 | 1.1 |
| CR4020 | 4.0±0.2 | 4.0±0.2 | 2.0Max | 3.3±0.2 | 0.95±0.2 | 2.1±0.2 | 3.7 | 1.9 | 1.1 |
| CR4030 | 4.0±0.2 | 4.0±0.2 | 3.0Max | 3.3±0.2 | 0.95±0.2 | 2.1±0.2 | 3.7 | 1.9 | 1.1 |
| CR4032 | 4.0±0.2 | 4.0±0.2 | 3.50Max | 3.3±0.2 | 0.95±0.2 | 2.1±0.2 | 3.7 | 1.9 | 1.1 |

Electronic Characteristics List

| Part Number | Inductance (uH) | Tolerance (±%) | DCR(mΩ) ±25% | Isat (A) | Irise(A) | Test Condition |
|-------------|-----------------|----------------|--------------|----------|----------|----------------|
| CR4010-1R0N | 1.0 | 30 | 56 | 2.00 | 1.90 | 100KHz /0.25V |
| CR4010-1R5N | 1.5 | 30 | 70 | 1.68 | 1.70 | 100KHz /0.25V |
| CR4010-2R2M | 2.2 | 20 | 85 | 1.20 | 1.50 | 100KHz /0.25V |
| CR4010-3R3M | 3.3 | 20 | 100 | 1.10 | 1.40 | 100KHz /0.25V |
| CR4010-4R7M | 4.7 | 20 | 140 | 0.95 | 1.20 | 100KHz /0.25V |
| CR4010-6R8M | 6.8 | 20 | 200 | 0.80 | 1.00 | 100KHz /0.25V |
| CR4010-100M | 10 | 20 | 300 | 0.62 | 0.75 | 100KHz /0.25V |
| CR4010-150M | 15 | 20 | 430 | 0.54 | 0.60 | 100KHz /0.25V |
| CR4010-220M | 22 | 20 | 570 | 0.45 | 0.50 | 100KHz /0.25V |

Wound Ferrite SMD Inductor for Power Circuit-----CR Series

Operating Temp. : -40°C~125°C(including self-heating)

| Part Number | Inductance (uH) | Tolerance (±%) | DCR(mΩ) ±25% | Isat (A) | Irise(A) | Test Condition |
|-------------|-----------------|----------------|--------------|----------|----------|----------------|
| CR4012-R82N | 0.82 | 30 | 50 | 3.02 | 1.65 | 100KHz /0.25V |
| CR4012-1R0N | 1.0 | 30 | 50 | 2.61 | 1.65 | 100KHz /0.25V |
| CR4012-1R5N | 1.5 | 30 | 65 | 2.10 | 1.46 | 100KHz /0.25V |
| CR4012-1R8N | 1.8 | 30 | 80 | 2.12 | 1.32 | 100KHz /0.25V |
| CR4012-2R2N | 2.2 | 30 | 85 | 1.90 | 1.32 | 100KHz /0.25V |
| CR4012-2R7N | 2.7 | 30 | 90 | 1.76 | 1.25 | 100KHz /0.25V |
| CR4012-3R3N | 3.3 | 30 | 110 | 1.72 | 1.12 | 100KHz /0.25V |
| CR4012-3R6N | 3.6 | 30 | 110 | 1.20 | 1.12 | 100KHz /0.25V |
| CR4012-4R3N | 4.3 | 30 | 140 | 1.58 | 1.00 | 100KHz /0.25V |
| CR4012-4R7N | 4.7 | 30 | 125 | 1.15 | 1.05 | 100KHz /0.25V |
| CR4012-5R1N | 5.1 | 30 | 155 | 1.55 | 0.95 | 100KHz /0.25V |
| CR4012-5R6N | 5.6 | 30 | 140 | 1.00 | 1.00 | 100KHz /0.25V |
| CR4012-6R8M | 6.8 | 20 | 198 | 0.85 | 0.84 | 100KHz /0.25V |
| CR4012-100M | 10 | 20 | 265 | 0.80 | 0.77 | 100KHz /0.25V |
| CR4012-120M | 12 | 20 | 290 | 0.66 | 0.70 | 100KHz /0.25V |
| CR4012-150M | 15 | 20 | 340 | 0.56 | 0.64 | 100KHz /0.25V |
| CR4012-180M | 18 | 20 | 470 | 0.55 | 0.55 | 100KHz /0.25V |
| CR4012-220M | 22 | 20 | 587 | 0.46 | 0.49 | 100KHz /0.25V |
| CR4015-1R5N | 1.5 | 30 | 40 | 2.70 | 2.20 | 100KHz /0.25V |
| CR4015-2R2M | 2.2 | 20 | 53 | 2.10 | 2.00 | 100KHz /0.25V |
| CR4015-3R3M | 3.3 | 20 | 75 | 1.90 | 1.80 | 100KHz /0.25V |
| CR4015-4R7M | 4.7 | 20 | 100 | 1.45 | 1.35 | 100KHz /0.25V |
| CR4015-6R8M | 6.8 | 20 | 135 | 1.30 | 1.20 | 100KHz /0.25V |
| CR4015-100M | 10 | 20 | 200 | 1.10 | 1.00 | 100KHz /0.25V |
| CR4015-150M | 15 | 20 | 300 | 0.90 | 0.85 | 100KHz /0.25V |
| CR4015-220M | 22 | 20 | 400 | 0.72 | 0.68 | 100KHz /0.25V |
| CR4018-1R0N | 1.0 | 30 | 23 | 4.5 | 2.50 | 100KHz /0.25V |
| CR4018-1R5N | 1.5 | 30 | 33 | 3.35 | 2.34 | 100KHz /0.25V |
| CR4018-2R2M | 2.2 | 20 | 44 | 2.70 | 2.00 | 100KHz /0.25V |
| CR4018-3R3M | 3.3 | 20 | 70 | 2.45 | 1.90 | 100KHz /0.25V |
| CR4018-4R7M | 4.7 | 20 | 90 | 1.70 | 1.70 | 100KHz /0.25V |
| CR4018-5R6M | 5.6 | 20 | 103 | 1.60 | 1.50 | 100KHz /0.25V |
| CR4018-6R8M | 6.8 | 20 | 124 | 1.45 | 1.30 | 100KHz /0.25V |
| CR4018-100M | 10 | 20 | 200 | 1.30 | 1.10 | 100KHz /0.25V |
| CR4018-150M | 15 | 20 | 268 | 0.94 | 0.92 | 100KHz /0.25V |
| CR4018-220M | 22 | 20 | 390 | 0.80 | 0.80 | 100KHz /0.25V |
| CR4018-330M | 33 | 20 | 560 | 0.65 | 0.60 | 100KHz /0.25V |
| CR4018-470M | 47 | 20 | 756 | 0.57 | 0.50 | 100KHz /0.25V |

Isat (A):

The saturation current value (Isat) is the DC current value having inductance decrease down to 30%(at 20°C).

Irise(A)

The temperature rise current value (Irise) is the DC current having temperature increase up to 40°C(at 20°C)

Remarks:

With the series of other highly products have been improved

同系列其他高度的产品已在完善中

Wound Ferrite SMD Inductor for Power Circuit-----CR Series

Operating Temp. : -40°C~125°C(including self-heating)

| Part Number | Inductance (uH) | Tolerance (±%) | DCR(mΩ) ±25% | Isat (A) | Irise(A) | Test Condition |
|-------------|-----------------|----------------|--------------|----------|----------|----------------|
| CR4020-1R0N | 1.0 | 30 | 29 | 5.10 | 2.15 | 100KHz /0.25V |
| CR4020-1R2N | 1.2 | 30 | 29 | 4.78 | 2.15 | 100KHz /0.25V |
| CR4020-1R5N | 1.5 | 30 | 35 | 4.45 | 1.98 | 100KHz /0.25V |
| CR4020-2R2N | 2.2 | 30 | 40 | 3.20 | 1.85 | 100KHz /0.25V |
| CR4020-3R3M | 3.3 | 20 | 70 | 3.10 | 1.40 | 100KHz /0.25V |
| CR4020-3R6M | 3.6 | 20 | 55 | 2.80 | 1.54 | 100KHz /0.25V |
| CR4020-4R7M | 4.7 | 20 | 75 | 2.35 | 1.34 | 100KHz /0.25V |
| CR4020-5R1M | 5.1 | 20 | 85 | 2.30 | 1.27 | 100KHz /0.25V |
| CR4020-5R6M | 5.6 | 20 | 90 | 2.20 | 1.22 | 100KHz /0.25V |
| CR4020-6R2M | 6.2 | 20 | 115 | 2.15 | 1.08 | 100KHz /0.25V |
| CR4020-6R8M | 6.8 | 20 | 125 | 2.20 | 1.04 | 100KHz /0.25V |
| CR4020-7R5M | 7.5 | 20 | 115 | 1.85 | 1.08 | 100KHz /0.25V |
| CR4020-8R2M | 8.2 | 20 | 125 | 1.75 | 1.04 | 100KHz /0.25V |
| CR4020-100M | 10 | 20 | 165 | 1.60 | 0.90 | 100KHz /0.25V |
| CR4020-120M | 12 | 20 | 175 | 1.50 | 0.88 | 100KHz /0.25V |
| CR4020-150M | 15 | 20 | 230 | 1.35 | 0.77 | 100KHz /0.25V |
| CR4020-220M | 22 | 20 | 350 | 1.05 | 0.62 | 100KHz /0.25V |
| CR4030-R91N | 0.91 | 30 | 13 | 6.25 | 4.00 | 100KHz /0.25V |
| CR4030-1R2N | 1.2 | 30 | 15 | 5.80 | 3.82 | 100KHz /0.25V |
| CR4030-1R5N | 1.5 | 30 | 20 | 4.84 | 3.34 | 100KHz /0.25V |
| CR4030-1R8N | 1.8 | 30 | 28 | 4.80 | 3.00 | 100KHz /0.25V |
| CR4030-2R2N | 2.2 | 30 | 35 | 4.10 | 2.95 | 100KHz /0.25V |
| CR4030-3R3M | 3.3 | 20 | 40 | 3.30 | 2.40 | 100KHz /0.25V |
| CR4030-4R3M | 4.3 | 20 | 55 | 2.95 | 2.10 | 100KHz /0.25V |
| CR4030-4R7M | 4.7 | 20 | 60 | 2.90 | 2.00 | 100KHz /0.25V |
| CR4030-5R6M | 5.6 | 20 | 65 | 2.60 | 1.95 | 100KHz /0.25V |
| CR4030-6R8M | 6.8 | 20 | 90 | 2.75 | 1.60 | 100KHz /0.25V |
| CR4030-7R5M | 7.5 | 20 | 85 | 2.20 | 1.65 | 100KHz /0.25V |
| CR4030-8R2M | 8.2 | 20 | 90 | 2.10 | 1.60 | 100KHz /0.25V |
| CR4030-100M | 10 | 20 | 100 | 1.95 | 1.50 | 100KHz /0.25V |
| CR4030-120M | 12 | 20 | 135 | 1.70 | 1.30 | 100KHz /0.25V |
| CR4030-150M | 15 | 20 | 190 | 1.65 | 1.11 | 100KHz /0.25V |
| CR4030-180M | 18 | 20 | 200 | 1.40 | 1.10 | 100KHz /0.25V |
| CR4030-220M | 22 | 20 | 225 | 1.30 | 1.00 | 100KHz /0.25V |
| CR4030-330M | 33 | 20 | 330 | 1.10 | 0.84 | 100KHz /0.25V |
| CR4030-360M | 36 | 20 | 335 | 1.05 | 0.83 | 100KHz /0.25V |
| CR4030-390M | 39 | 20 | 435 | 1.03 | 0.73 | 100KHz /0.25V |
| CR4030-470M | 47 | 20 | 445 | 0.95 | 0.72 | 100KHz /0.25V |

Isat (A):

The saturation current value (Isat) is the DC current value having inductance decrease down to 30%(at 20°C)。

Irise(A)

The temperature rise current value (Irise) is the DC current having temperature increase up to 40°C(at 20°C)

Remarks:

With the series of other highly products have been improved

同系列其他高度的产品已在完善中

Wound Ferrite SMD Inductor for Power Circuit-----CR Series

Operating Temp. : -40°C~125°C(including self-heating)



※CR5 Series

Shape and Dimension (Unit:mm)

Recommended Land Pattern

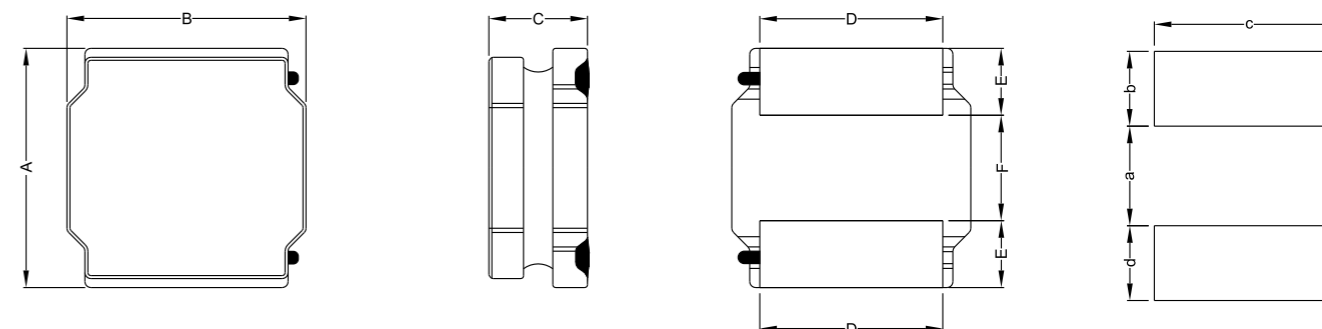

| Series | A | B | C Max | D | E | F | a Typ. | b Typ. | c Typ. |
|--------|---------|---------|-------|---------|----------|---------|--------|--------|--------|
| CR5015 | 5.0±0.2 | 5.0±0.2 | 1.5 | 4.0±0.2 | 1.25±0.2 | 2.5±0.2 | 4.2 | 2.3 | 1.4 |
| CR5020 | 5.0±0.2 | 5.0±0.2 | 2.0 | 4.0±0.2 | 1.25±0.2 | 2.5±0.2 | 4.2 | 2.3 | 1.4 |
| CR5030 | 5.0±0.2 | 5.0±0.2 | 3.0 | 4.0±0.2 | 1.25±0.2 | 2.5±0.2 | 4.2 | 2.3 | 1.4 |
| CR5040 | 5.0±0.2 | 5.0±0.2 | 4.0 | 4.0±0.2 | 1.25±0.2 | 2.5±0.2 | 4.2 | 2.3 | 1.4 |

Electronic Characteristics List

| Part Number | Inductance (uH) | Tolerance (±%) | DCR(mΩ) ±25% | Isat (A) | Irise(A) | Test Condition |
|-------------|-----------------|----------------|--------------|----------|----------|----------------|
| CR5015-1R0N | 1.0 | 30 | 35 | 4.50 | 2.80 | 100KHz /0.25V |
| CR5015-1R5N | 1.5 | 30 | 50 | 3.50 | 2.50 | 100KHz /0.25V |
| CR5015-2R2N | 2.2 | 30 | 65 | 3.00 | 2.20 | 100KHz /0.25V |
| CR5015-3R3N | 3.3 | 30 | 80 | 2.50 | 1.90 | 100KHz /0.25V |
| CR5015-4R7N | 4.7 | 30 | 100 | 2.10 | 1.60 | 100KHz /0.25V |
| CR5015-6R8M | 6.8 | 20 | 150 | 1.65 | 1.40 | 100KHz /0.25V |
| CR5015-100M | 10 | 20 | 200 | 1.45 | 1.20 | 100KHz /0.25V |
| CR5020-1R0N | 1.0 | 30 | 20 | 4.33 | 3.70 | 100KHz /0.25V |
| CR5020-1R5N | 1.5 | 30 | 26 | 4.10 | 3.20 | 100KHz /0.25V |
| CR5020-2R2N | 2.2 | 30 | 38 | 3.85 | 2.90 | 100KHz /0.25V |
| CR5020-3R3N | 3.3 | 30 | 46 | 3.25 | 2.40 | 100KHz /0.25V |
| CR5020-4R7M | 4.7 | 20 | 65 | 2.40 | 2.05 | 100KHz /0.25V |
| CR5020-6R8M | 6.8 | 20 | 92 | 2.10 | 1.70 | 100KHz /0.25V |
| CR5020-100M | 10 | 20 | 125 | 1.80 | 1.50 | 100KHz /0.25V |
| CR5020-150M | 15 | 20 | 180 | 1.44 | 1.25 | 100KHz /0.25V |
| CR5020-220M | 22 | 20 | 250 | 1.18 | 1.05 | 100KHz /0.25V |
| CR5020-330M | 33 | 20 | 370 | 0.97 | 0.83 | 100KHz /0.25V |
| CR5020-470M | 47 | 20 | 560 | 0.81 | 0.70 | 100KHz /0.25V |

Isat (A):

The saturation current value (Isat) is the DC current value having inductance decrease down to 30%(at 20°C)。

Irise(A)

The temperature rise current value (Irise) is the DC current having temperature increase up to 40°C(at 20°C)

Remarks:

With the series of other highly products have been improved

同系列其他高度的产品已在完善中

Wound Ferrite SMD Inductor for Power Circuit-----CR Series

Operating Temp. : -40°C~125°C(including self-heating)

| Part Number | Inductance (uH) | Tolerance (±%) | DCR(mΩ) ±25% | Isat (A) | Irise(A) | Test Condition |
|-------------|-----------------|----------------|--------------|----------|----------|----------------|
| CR5040-1R0N | 1.0 | 30 | 12 | 7.35 | 4.90 | 100KHz /0.25V |
| CR5040-1R5N | 1.5 | 30 | 15 | 6.30 | 4.30 | 100KHz /0.25V |
| CR5040-2R2N | 2.2 | 30 | 19 | 4.90 | 3.80 | 100KHz /0.25V |
| CR5040-2R7N | 2.7 | 30 | 22 | 4.30 | 3.60 | 100KHz /0.25V |
| CR5040-3R3N | 3.3 | 30 | 24 | 3.95 | 3.40 | 100KHz /0.25V |
| CR5040-3R9N | 3.9 | 30 | 27 | 3.55 | 3.20 | 100KHz /0.25V |
| CR5040-4R7N | 4.7 | 30 | 30 | 3.50 | 3.00 | 100KHz /0.25V |
| CR5040-6R8M | 6.8 | 20 | 43 | 2.90 | 2.50 | 100KHz /0.25V |
| CR5040-100M | 10 | 20 | 64 | 2.35 | 2.10 | 100KHz /0.25V |
| CR5040-150M | 15 | 20 | 86 | 2.00 | 2.00 | 100KHz /0.25V |
| CR5040-220M | 22 | 20 | 129 | 1.60 | 1.50 | 100KHz /0.25V |
| CR5040-330M | 33 | 20 | 188 | 1.30 | 1.20 | 100KHz /0.25V |
| CR5040-470M | 47 | 20 | 272 | 1.10 | 1.00 | 100KHz /0.25V |
| CR5040-680M | 68 | 20 | 400 | 0.90 | 0.80 | 100KHz /0.25V |
| CR5040-101M | 100 | 20 | 560 | 0.75 | 0.70 | 100KHz /0.25V |

Isat (A):

The saturation current value (Isat) is the DC current value having inductance decrease down to 30%(at 20°C)。

Irise(A)

The temperature rise current value (Irise) is the DC current having temperature increase up to 40°C(at 20°C)

Remarks:

With the series of other highly products have been improved

同系列其他高度的产品已在完善中

Wound Ferrite SMD Inductor for Power Circuit-----CR Series

Operating Temp. : -40°C~125°C(including self-heating)

※CR6 Series

Shape and Dimension (Unit:mm)

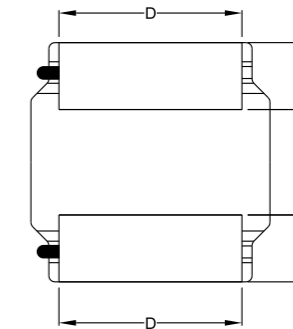
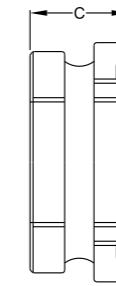
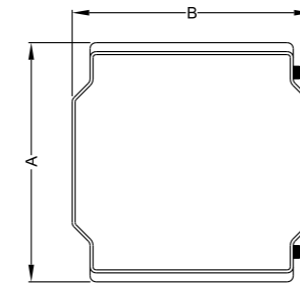

Recommended Land Pattern

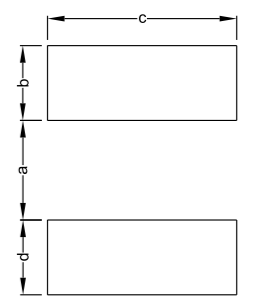

| Series | A | B | C Max | D | E | F | a Typ. | b Typ. | c Typ. |
|--------|---------|---------|-------|---------|----------|---------|--------|--------|--------|
| CR6010 | 6.0±0.3 | 6.0±0.3 | 1.0 | 4.9±0.3 | 1.55±0.3 | 2.9±0.3 | 1.7 | 2.8 | 5.7 |
| CR6012 | 6.0±0.3 | 6.0±0.3 | 1.2 | 4.9±0.3 | 1.55±0.3 | 2.9±0.3 | 1.7 | 2.8 | 5.7 |
| CR6015 | 6.0±0.3 | 6.0±0.3 | 1.5 | 4.9±0.3 | 1.55±0.3 | 2.9±0.3 | 1.7 | 2.8 | 5.7 |
| CR6020 | 6.0±0.3 | 6.0±0.3 | 2.0 | 4.9±0.3 | 1.55±0.3 | 2.9±0.3 | 1.7 | 2.8 | 5.7 |
| CR6028 | 6.0±0.3 | 6.0±0.3 | 2.8 | 4.9±0.3 | 1.55±0.3 | 2.9±0.3 | 1.7 | 2.8 | 5.7 |
| CR6045 | 6.0±0.3 | 6.0±0.3 | 4.5 | 4.9±0.3 | 1.55±0.3 | 2.9±0.3 | 1.7 | 2.8 | 5.7 |

Electronic Characteristics List

| Part Number | Inductance (uH) | Tolerance (±%) | DCR(mΩ) ±25% | Isat (A) | Irise(A) | Test Condition |
|-------------|-----------------|----------------|--------------|----------|----------|----------------|
| CR6015-1R2N | 1.2 | 30 | 35 | 4.20 | 2.80 | 100KHz /0.25V |
| CR6015-2R2N | 2.2 | 30 | 50 | 3.10 | 2.30 | 100KHz /0.25V |
| CR6015-3R3N | 3.3 | 30 | 60 | 2.60 | 2.10 | 100KHz /0.25V |
| CR6015-4R7M | 4.7 | 20 | 90 | 2.10 | 1.90 | 100KHz /0.25V |
| CR6015-6R8M | 6.8 | 20 | 115 | 1.80 | 1.65 | 100KHz /0.25V |
| CR6015-100M | 10 | 20 | 155 | 1.45 | 1.35 | 100KHz /0.25V |
| CR6015-150M | 15 | 20 | 220 | 1.20 | 1.20 | 100KHz /0.25V |
| CR6015-220M | 22 | 20 | 320 | 1.00 | 1.00 | 100KHz /0.25V |
| CR6020-1R0N | 1.0 | 30 | 20 | 4.30 | 3.50 | 100KHz /0.25V |
| CR6020-1R5N | 1.5 | 30 | 25 | 4.25 | 3.20 | 100KHz /0.25V |
| CR6020-2R2N | 2.2 | 30 | 35 | 3.75 | 2.75 | 100KHz /0.25V |
| CR6020-3R3N | 3.3 | 30 | 45 | 3.15 | 2.60 | 100KHz /0.25V |
| CR6020-4R7N | 4.7 | 30 | 58 | 3.00 | 2.00 | 100KHz /0.25V |
| CR6020-5R6M | 5.6 | 20 | 70 | 2.40 | 1.90 | 100KHz /0.25V |
| CR6020-6R8M | 6.8 | 20 | 85 | 2.20 | 1.80 | 100KHz /0.25V |
| CR6020-100M | 10 | 20 | 120 | 1.75 | 1.40 | 100KHz /0.25V |
| CR6020-150M | 15 | 20 | 160 | 1.50 | 1.20 | 100KHz /0.25V |
| CR6020-220M | 22 | 20 | 240 | 1.25 | 1.00 | 100KHz /0.25V |
| CR6020-470M | 47 | 20 | 500 | 1.00 | 0.80 | 100KHz /0.25V |

Isat (A):

The saturation current value (Isat) is the DC current value having inductance decrease down to 30%(at 20°C)。

Irise(A)

The temperature rise current value (Irise) is the DC current having temperature increase up to 40°C(at 20°C)

Remarks:

With the series of other highly products have been improved

同系列其他高度的产品已在完善中

Wound Ferrite SMD Inductor for Power Circuit-----CR Series

Operating Temp. : -40°C~125°C(including self-heating)

| Part Number | Inductance (uH) | Tolerance (±%) | DCR(mΩ) ±25% | Isat (A) | Irise(A) | Test Condition |
|-------------|-----------------|----------------|--------------|----------|----------|----------------|
| CR6028-1R0N | 1.0 | 30 | 10 | 5.75 | 5.20 | 100KHz /0.25V |
| CR6028-1R5N | 1.5 | 30 | 13 | 6.00 | 4.58 | 100KHz /0.25V |
| CR6028-2R2N | 2.2 | 30 | 20 | 5.10 | 3.75 | 100KHz /0.25V |
| CR6028-2R7N | 2.7 | 30 | 20 | 3.80 | 3.75 | 100KHz /0.25V |
| CR6028-3R3N | 3.3 | 30 | 25 | 4.15 | 3.48 | 100KHz /0.25V |
| CR6028-4R7N | 4.7 | 30 | 30 | 3.00 | 3.08 | 100KHz /0.25V |
| CR6028-5R1N | 5.1 | 30 | 43 | 3.20 | 2.60 | 100KHz /0.25V |
| CR6028-6R2M | 6.2 | 20 | 47 | 3.05 | 2.40 | 100KHz /0.25V |
| CR6028-6R8M | 6.8 | 20 | 47 | 2.60 | 2.40 | 100KHz /0.25V |
| CR6028-8R2M | 8.2 | 20 | 55 | 2.30 | 2.25 | 100KHz /0.25V |
| CR6028-9R1M | 9.1 | 20 | 74 | 2.55 | 2.15 | 100KHz /0.25V |
| CR6028-100M | 10 | 20 | 72 | 2.04 | 1.95 | 100KHz /0.25V |
| CR6028-120M | 12 | 20 | 80 | 1.80 | 1.85 | 100KHz /0.25V |
| CR6028-150M | 15 | 20 | 125 | 1.75 | 1.45 | 100KHz /0.25V |
| CR6028-180M | 18 | 20 | 120 | 1.52 | 1.45 | 100KHz /0.25V |
| CR6028-220M | 22 | 20 | 140 | 1.45 | 1.40 | 100KHz /0.25V |
| CR6028-270M | 27 | 20 | 155 | 1.50 | 1.32 | 100KHz /0.25V |
| CR6028-330M | 33 | 20 | 185 | 1.35 | 1.22 | 100KHz /0.25V |
| CR6028-360M | 36 | 20 | 215 | 1.25 | 1.13 | 100KHz /0.25V |
| CR6045-1R0N | 1.0 | 30 | 10 | 9.0 | 5.1 | 100KHz /0.25V |
| CR6045-2R2N | 2.2 | 30 | 13 | 6.5 | 4.6 | 100KHz /0.25V |
| CR6045-3R3N | 3.3 | 30 | 20 | 5.3 | 3.2 | 100KHz /0.25V |
| CR6045-4R7N | 4.7 | 30 | 24 | 4.5 | 3.0 | 100KHz /0.25V |
| CR6045-5R6N | 5.6 | 30 | 31 | 3.7 | 2.8 | 100KHz /0.25V |
| CR6045-6R8M | 6.8 | 20 | 33 | 3.3 | 2.7 | 100KHz /0.25V |
| CR6045-100M | 10 | 20 | 52 | 3.0 | 2.5 | 100KHz /0.25V |
| CR6045-150M | 15 | 20 | 77 | 2.5 | 1.9 | 100KHz /0.25V |
| CR6045-220M | 22 | 20 | 115 | 2.0 | 1.5 | 100KHz /0.25V |
| CR6045-330M | 33 | 20 | 150 | 1.6 | 1.45 | 100KHz /0.25V |
| CR6045-470M | 47 | 20 | 220 | 1.4 | 1.20 | 100KHz /0.25V |
| CR6045-560M | 56 | 20 | 260 | 1.3 | 1.10 | 100KHz /0.25V |
| CR6045-680M | 68 | 20 | 290 | 1.2 | 0.9 | 100KHz /0.25V |
| CR6045-101M | 100 | 20 | 430 | 1.0 | 0.8 | 100KHz /0.25V |

Isat (A):

The saturation current value (Isat) is the DC current value having inductance decrease down to 30%(at 20°C).

Irise(A)

The temperature rise current value (Irise) is the DC current having temperature increase up to 40°C(at 20°C)

Remarks:

With the series of other highly products have been improved

同系列其他高度的产品已在完善中

Wound Ferrite SMD Inductor for Power Circuit-----CR Series

Operating Temp. : -40°C~125°C(including self-heating)

※CR8 Series

Shape and Dimension (Unit:mm)

Recommended Land Pattern

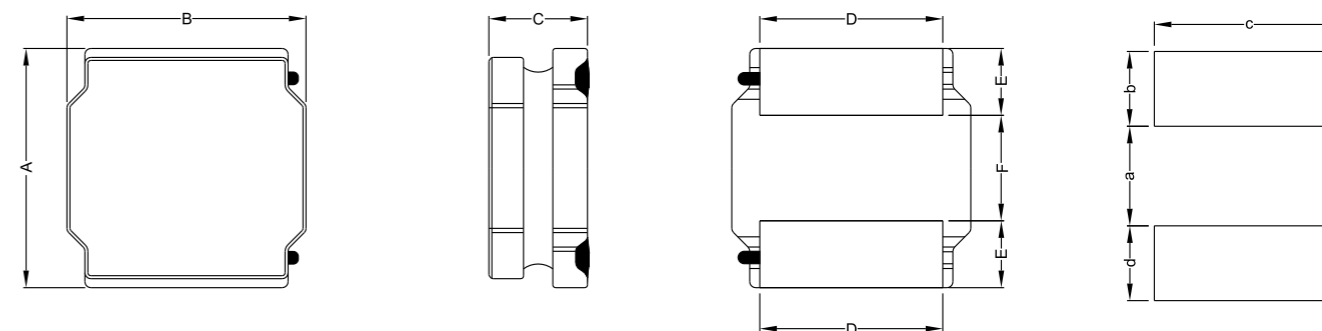

| Series | A | B | C | D | E | F | a Typ. | b Typ. | c Typ. |
|--------|-----------|-----------|--------|---------|---------|---------|--------|--------|--------|
| CR8040 | 8.0 ± 0.3 | 8.0 ± 0.3 | 4.2Max | 6.3±0.3 | 2.2±0.3 | 4.0±0.3 | 2.2 | 3.8 | 7.5 |

Electronic Characteristics List

| Part Number | Inductance (uH) | Tolerance (±%) | DCR(mΩ) ±25% | Isat (A) | Irise(A) | Test Condition |
|-------------|-----------------|----------------|--------------|----------|----------|----------------|
| CR8040-1R0N | 1.0 | 30 | 8 | 9.85 | 6.30 | 100KHz /0.25V |
| CR8040-1R5N | 1.0 | 30 | 10 | 8.15 | 5.65 | 100KHz /0.25V |
| CR8040-2R2N | 2.2 | 30 | 12 | 7.10 | 5.15 | 100KHz /0.25V |
| CR8040-3R3N | 3.3 | 30 | 17 | 6.50 | 4.40 | 100KHz /0.25V |
| CR8040-4R7N | 4.7 | 30 | 20 | 5.90 | 4.00 | 100KHz /0.25V |
| CR8040-5R6N | 5.6 | 30 | 24 | 5.50 | 3.80 | 100KHz /0.25V |
| CR8040-6R8M | 6.8 | 20 | 28 | 4.55 | 3.60 | 100KHz /0.25V |
| CR8040-8R2M | 8.2 | 20 | 35 | 4.20 | 3.40 | 100KHz /0.25V |
| CR8040-100M | 10 | 20 | 37 | 3.60 | 3.10 | 100KHz /0.25V |
| CR8040-150M | 15 | 20 | 56 | 2.95 | 2.50 | 100KHz /0.25V |
| CR8040-220M | 22 | 20 | 74 | 2.40 | 2.00 | 100KHz /0.25V |
| CR8040-330M | 33 | 20 | 100 | 2.05 | 1.70 | 100KHz /0.25V |
| CR8040-470M | 47 | 20 | 158 | 1.75 | 1.50 | 100KHz /0.25V |
| CR8040-680M | 68 | 20 | 196 | 1.45 | 1.20 | 100KHz /0.25V |
| CR8040-101M | 100 | 20 | 295 | 1.15 | 1.00 | 100KHz /0.25V |
| CR8040-151M | 150 | 20 | 470 | 1.10 | 0.80 | 100KHz /0.25V |
| CR8040-221M | 220 | 20 | 660 | 0.85 | 0.70 | 100KHz /0.25V |
| CR8040-331M | 330 | 20 | 970 | 0.68 | 0.55 | 100KHz /0.25V |

Isat (A):

The saturation current value (Isat) is the DC current value having inductance decrease down to 30%(at 20°C).

Irise(A)

The temperature rise current value (Irise) is the DC current having temperature increase up to 40°C(at 20°C)

Remarks:

With the series of other highly products have been improved

同系列其他高度的产品已在完善中

Molding Power Choke-----SHI Series

Operating Temp. : -40°C~125°C(including self-heating)



Feature

- Shielded construction
- Handles high transient current spikes without saturation
- Ultra low buzz noise, due to composite construction
- 100% Pb lead(Pb) free meet RoHS standard

Application

- PAD/Notebook/Desktop/sever application
- Low profile, high current power supplies
- Battery powered devices
- DC/DC converter for Filed Programmable Gate Array (FPGA)

Production identification

SHI 0603 1R0 M

① ② ③ ④

| |
|--------------|
| SHI ① |
| Product Name |

| |
|------------------|
| 1R0 ③ |
| Inductance Value |
| 1R0 :1.0uH |

| ② External Dimensions {L x W x H[max.]} [Unit: mm] | |
|--|------------------|
| 0402 | 4.1 x 4.5 x 2.0 |
| 0515 | 5.4 x 5.75 x 1.8 |
| 0603 | 6.6 x 7.1 x 3.0 |

| |
|-----------|
| M ④ |
| Tolerance |
| M : ± 20% |
| N : ± 30% |

※SHI Series

Shape and Dimension (Unit:mm)

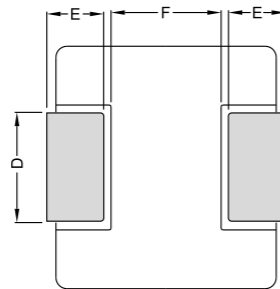
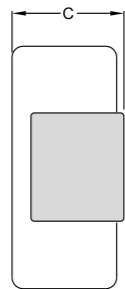
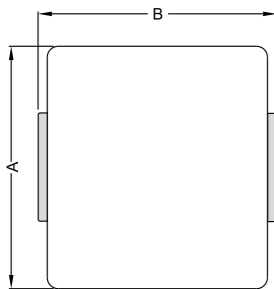

Recommended Land Pattern

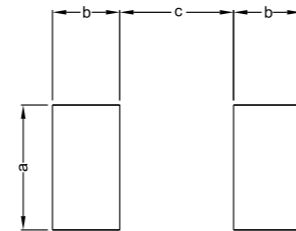

| Series | A | B | C | D | E | F | a Typ. | b Typ. | c Typ. |
|---------|-----------|-----------|--------|--------|--------|--------|--------|---------|--------|
| SHI0402 | 4.1 ± 0.2 | 4.5 ± 0.2 | 2.0Max | 1.5Ref | 0.8Ref | 2.2Ref | 2.5Ref | 1.5Ref | 2.3Ref |
| SHI0515 | 5.4 ± 0.2 | 5.7 ± 0.2 | 1.8Max | 2.0Ref | 1.2Ref | 2.4Ref | 2.5Ref | 1.5Ref | 2.2Ref |
| SHI0603 | 6.6 ± 0.2 | 7.1 ± 0.2 | 3.0Max | 3.0Ref | 1.8Ref | 3.5Ref | 3.5Ref | 2.45Ref | 3.5Ref |

Molding Power Choke-----SHI Series

Operating Temp. : -40°C~125°C(including self-heating)

Electronic Characteristics List

| P/N | L0 Inductance uH±20% @0A | DCR | | Heat Rating Current | Saturation Current |
|--------------|--------------------------------|---------|-------|------------------------|------------------------|
| | | Typical | Max | Idc(Amp) Typical※ 1 | Isat(Amp) Typical※2 |
| SHI0402-R15M | 0.15 | 5.0 | 5.5 | 10.0 | 15.0 |
| SHI0402-R22M | 0.22 | 6.0 | 6.6 | 9.0 | 12.5 |
| SHI0402-R33M | 0.33 | 11.0 | 12.0 | 8.0 | 11.0 |
| SHI0402-R47M | 0.47 | 12.0 | 14.0 | 7.0 | 9.5 |
| SHI0402-R68M | 0.68 | 19.5 | 21.0 | 5.0 | 8.0 |
| SHI0402-1R0M | 1.0 | 25.0 | 27.0 | 4.5 | 7.0 |
| SHI0402-1R5M | 1.5 | 42.0 | 46.0 | 4.0 | 6.0 |
| SHI0402-2R2M | 2.2 | 52.0 | 58.0 | 3.0 | 5.0 |
| SHI0402-3R3M | 3.3 | 78.0 | 87.0 | 2.5 | 4.0 |
| SHI0402-4R7M | 4.7 | 105.0 | 115.0 | 2.4 | 3.0 |
| SHI0515-1R0M | 1.0 | 20.0 | 23.0 | 6.5 | 9.0 |
| SHI0515-1R2M | 1.2 | 29.3 | 33.7 | 5.3 | 8.0 |
| SHI0515-2R2M | 2.2 | 58.0 | 64.0 | 3.3 | 6.0 |
| SHI0515-3R3M | 3.3 | 65.0 | 72.0 | 3.2 | 5.0 |
| SHI0515-4R7M | 4.7 | 95.0 | 106.0 | 3.0 | 4.0 |
| SHI0515-6R8M | 6.8 | 120.0 | 130.0 | 2.5 | 3.2 |
| SHI0515-100M | 10.0 | 153.0 | 170.0 | 2.0 | 3.0 |
| SHI0515-150M | 15.0 | 310.0 | 350.0 | 1.3 | 2.3 |
| SHI0603-R15M | 0.15 | 1.9 | 2.5 | 22.5 | 42.0 |
| SHI0603-R20M | 0.20 | 2.4 | 3.0 | 19.5 | 41.0 |
| SHI0603-R22M | 0.22 | 2.5 | 3.5 | 19.0 | 40.0 |
| SHI0603-R33M | 0.33 | 3.5 | 3.9 | 17.0 | 30.0 |
| SHI0603-R47M | 0.47 | 4.0 | 4.5 | 14.0 | 20.0 |
| SHI0603-R68M | 0.68 | 5.5 | 6.5 | 15.5 | 25.0 |
| SHI0603-R82M | 0.82 | 6.7 | 8.0 | 13.0 | 24.0 |
| SHI0603-1R0M | 1.0 | 9.0 | 10.0 | 11.0 | 22.0 |
| SHI0603-1R5M | 1.5 | 13.0 | 15.0 | 9.0 | 18.0 |
| SHI0603-2R2M | 2.2 | 16.0 | 20.0 | 8.0 | 14.0 |
| SHI0603-3R3M | 3.3 | 28.0 | 30.0 | 6.0 | 13.5 |
| SHI0603-4R7M | 4.7 | 37.0 | 40.0 | 5.5 | 10.0 |
| SHI0603-6R8M | 6.8 | 54.0 | 60.0 | 4.5 | 8.0 |
| SHI0603-8R2M | 8.2 | 64.0 | 68.0 | 4.0 | 7.5 |
| SHI0603-100M | 10.0 | 84.0 | 105.0 | 3.0 | 7.0 |

Isat (A): ※ 1

The saturation current value (Isat) is the DC current value having inductance decrease down to 25%(at 20°C).

Irise (A): ※ 2

The temperature rise current value (Irise) is the DC current having temperature increase up to 40°C(at 20°C).

Wound Ferrite SMD Inductor for Power Circuit-----CD Series

Operating Temp. : -40°C~125°C(including self-heating)



Feature

- Ferrite drum core construction.
- Magnetically unshielded.
- Moisture Sensitivity Level: 1
- RoHS compliance.
- Halogen Free available.

Application

- Ideally used in Mobilephone,PDA,MP3,DSC/DVC, portable DVD etc as DC-DC Converter inductors.

Production identification

CD 43 6R8 M T

① ② ③ ④ ⑤

| |
|-------------|
| ① CD |
| Series Name |

| |
|--------------------|
| ③ Inductance value |
| 6R8 -----> 6.8uH |
| 100----->10uH |

| |
|------------------------|
| ④ Inductance Tolerance |
| K-----> ± 10% |
| M-----> ± 20% |
| N-----> ± 30% |

| | |
|---|-----------------|
| ② External Dimensions (L × W × H.) [Unit: mm] | |
| CD32 | 3.0 × 3.5 × 2.4 |
| CD43 | 4.0 × 4.5 × 3.5 |
| CD54 | 5.2 × 5.8 × 4.8 |
| CD75 | 7.0 × 7.8 × 5.2 |

| |
|----------------------------|
| ⑤ Packing Type |
| T---->Tape Carrier Package |

※CD Series

Shape and Dimension (Unit:mm)

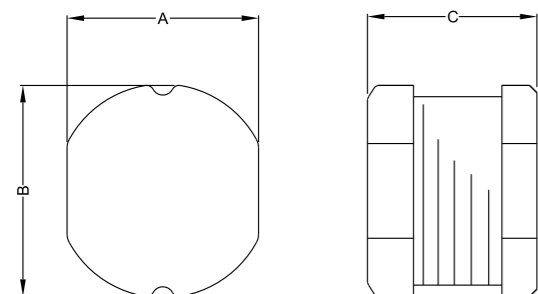

Recommended Land Pattern

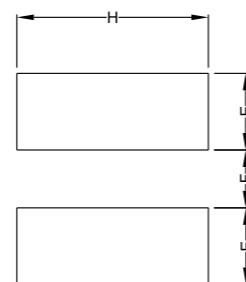

| Series | A | B | C | D | E Typ. | F Typ. | H Typ. |
|--------|---------|----------|--------|--------|---------|--------|--------|
| CD32 | 3.0±0.3 | 3.5±0.3 | 2.4Max | 1.0Ref | 1.3Ref | 0.9Ref | 3.5Ref |
| CD43 | 4.0±0.3 | 4.5±0.3 | 3.5Max | 1.5Ref | 1.8Ref | 1.2Ref | 4.5Ref |
| CD54 | 5.2±0.3 | 5.8±0.3 | 4.8Max | 1.5Ref | 2.6Ref | 1.0Ref | 5.8Ref |
| CD75 | 7.0±0.3 | 7.8±0.3 | 5.2Max | 2.5Ref | 3.0Ref | 2.0Ref | 7.5Ref |
| CD105 | 9.0±0.3 | 10.0±0.3 | 5.9Max | 3.0Ref | 3.75Ref | 2.5Ref | 9.5Ref |

Wound Ferrite SMD Inductor for Power Circuit-----CD Series

Operating Temp. : -40°C~125°C(including self-heating)

Electronic Characteristics List

| Part Name | Stamp | Inductance (μH) [Within] | D.C.R. (mΩ) [Max.] (20°C) | Rated Current (A) |
|-----------|-------|--------------------------|----------------------------|-------------------|
| CD43-1R0M | 1R0 | 1.0 | 23.0m | 2.60 |
| CD43-1R5M | 1R5 | 1.5 | 28.0m | 2.50 |
| CD43-2R2M | 2R2 | 2.2 | 42.0m | 2.30 |
| CD43-3R3M | 3R3 | 3.3 | 51.0m | 2.10 |
| CD43-3R9M | 3R9 | 3.9 | 60.0m | 1.90 |
| CD43-4R7M | 4R7 | 4.7 | 76.0m | 1.60 |
| CD43-5R6M | 5R6 | 5.6 | 83.0m | 1.45 |
| CD43-6R8M | 6R8 | 6.8 | 100.0m | 1.35 |
| CD43-8R2M | 8R2 | 8.2 | 120.0m | 1.30 |
| CD43-100K | 100 | 10 | 150.0m | 1.00 |
| CD43-120K | 120 | 12 | 155.0m | 0.90 |
| CD43-150K | 150 | 15 | 195.0m | 0.80 |
| CD43-180K | 180 | 18 | 230.0m | 0.70 |
| CD43-220K | 220 | 22 | 270.0m | 0.60 |
| CD43-270K | 270 | 27 | 310.0m | 0.55 |
| CD43-330K | 330 | 33 | 345.0m | 0.50 |
| CD43-390K | 390 | 39 | 400.0m | 0.48 |
| CD43-470K | 470 | 47 | 525.0m | 0.40 |
| CD43-560K | 560 | 56 | 595.0m | 0.38 |
| CD43-680K | 680 | 68 | 740.0m | 0.33 |
| CD43-820K | 820 | 82 | 880.0m | 0.29 |
| CD43-101K | 101 | 100 | 1.20 | 0.26 |
| CD43-121K | 121 | 120 | 1.25 | 0.24 |
| CD43-151K | 151 | 150 | 1.60 | 0.22 |
| CD43-181K | 181 | 180 | 2.00 | 0.19 |
| CD43-221K | 221 | 220 | 2.35 | 0.18 |
| CD43-271K | 271 | 270 | 3.25 | 0.16 |
| CD43-331K | 331 | 330 | 3.55 | 0.15 |
| CD43-391K | 391 | 390 | 4.20 | 0.13 |
| CD43-471K | 471 | 470 | 4.90 | 0.12 |
| CD43-561K | 561 | 560 | 6.50 | 0.10 |
| CD43-681K | 681 | 680 | 8.30 | 0.09 |

1. Inductance tolerance: M: ± 20%; K ± 10%

2. Inductance measuring frequency: L ≤ 10uH at 100KHz/0.25V
L > 10uH at 1KHz/0.25v

3. Rated current: The DC current at which the inductance decreases to 90% of it's initial value or when Δt=40°C, whichever is lower(Ta=20°C).

Wound Ferrite SMD Inductor for Power Circuit-----CD Series

Operating Temp. : -40°C~125°C(including self-heating)

Electronic Characteristics List

| Part Name | Stamp | Inductance (μ H) [Within] | D.C.R. (m Ω) [Max.] (20°C) | Rated Current (A) |
|-----------|-------|--------------------------------------|--|----------------------|
| CD54-1R0M | 1R0 | 1.0 | 13.0m | 5.4 |
| CD54-1R5M | 1R5 | 1.5 | 16.9m | 4.7 |
| CD54-1R8M | 1R8 | 1.8 | 19.5m | 4.5 |
| CD54-2R2M | 2R2 | 2.2 | 22.1m | 4.0 |
| CD54-3R3M | 3R3 | 3.3 | 31.2m | 3.7 |
| CD54-3R9M | 3R9 | 3.9 | 36.4m | 3.2 |
| CD54-4R7M | 4R7 | 4.7 | 52.0m | 3.1 |
| CD54-5R6M | 5R6 | 5.6 | 54.6m | 2.8 |
| CD54-6R8M | 6R8 | 6.8 | 60.0m | 2.4 |
| CD54-8R2M | 8R2 | 8.2 | 65.0m | 2.0 |
| CD54-100K | 100 | 10 | 76.0m | 1.42 |
| CD54-120K | 120 | 12 | 85.0m | 1.38 |
| CD54-150K | 150 | 15 | 105.0m | 1.28 |
| CD54-180K | 180 | 18 | 125.0m | 1.22 |
| CD54-220K | 220 | 22 | 150.0m | 1.10 |
| CD54-270K | 270 | 27 | 188.0m | 0.95 |
| CD54-330K | 330 | 33 | 215.0m | 0.86 |
| CD54-390K | 390 | 39 | 263.0m | 0.78 |
| CD54-470K | 470 | 47 | 355.0m | 0.71 |
| CD54-560K | 560 | 56 | 377.0m | 0.66 |
| CD54-680K | 680 | 68 | 390.0m | 0.60 |
| CD54-820K | 820 | 82 | 416.0m | 0.57 |
| CD54-101K | 101 | 100 | 611.0m | 0.51 |
| CD54-121K | 121 | 120 | 754.0m | 0.47 |
| CD54-151K | 151 | 150 | 845.0m | 0.38 |
| CD54-181K | 181 | 180 | 1.04 | 0.36 |
| CD54-221K | 221 | 220 | 1.45 | 0.34 |
| CD54-271K | 271 | 270 | 1.51 | 0.31 |
| CD54-331K | 331 | 330 | 1.76 | 0.28 |
| CD54-391K | 391 | 390 | 2.08 | 0.26 |
| CD54-471K | 471 | 470 | 2.99 | 0.24 |
| CD54-561K | 561 | 560 | 3.12 | 0.22 |
| CD54-681K | 681 | 680 | 3.90 | 0.20 |
| CD54-821K | 821 | 820 | 5.20 | 0.19 |

1. Inductance tolerance: M: \pm 20%; K \pm 10%

2. Inductance measuring frequency: $L \leq 10\mu$ H at 100KHz/0.25V
 $L > 10\mu$ H at 1KHz/0.25v

3. Rated current: The DC current at which the inductance decreases to 90% of it's initial value or when $\Delta t = 40^\circ\text{C}$, whichever is lower ($T_a = 20^\circ\text{C}$).

Wound Ferrite SMD Inductor for Power Circuit-----CD Series

Operating Temp. : -40°C~125°C(including self-heating)

Electronic Characteristics List

| Part Name | Stamp | Inductance (μ H) [Within] | D.C.R. (m Ω) [Max.] (20°C) | Rated Current (A) |
|-----------|-------|--------------------------------------|--|----------------------|
| CD75-1R0N | 1R0 | 1.0 | 13.00m | 5.20 |
| CD75-2R2M | 2R2 | 2.2 | 14.00m | 5.00 |
| CD75-2R7M | 2R7 | 2.7 | 16.90m | 4.60 |
| CD75-3R3M | 3R3 | 3.3 | 19.50m | 4.00 |
| CD75-3R9M | 3R9 | 3.9 | 23.40m | 4.00 |
| CD75-4R7M | 4R7 | 4.7 | 26.00m | 3.80 |
| CD75-5R6M | 5R6 | 5.6 | 27.30m | 3.10 |
| CD75-6R8M | 6R8 | 6.8 | 32.50m | 2.80 |
| CD75-8R2M | 8R2 | 8.2 | 39.00m | 2.52 |
| CD75-100K | 100 | 10 | 41.60m | 2.31 |
| CD75-120K | 120 | 12 | 49.40m | 2.00 |
| CD75-150K | 150 | 15 | 71.50m | 1.81 |
| CD75-180K | 180 | 18 | 84.50m | 1.59 |
| CD75-220K | 220 | 22 | 91.00m | 1.50 |
| CD75-270K | 270 | 27 | 106.60m | 1.28 |
| CD75-330K | 330 | 33 | 119.60m | 1.20 |
| CD75-390K | 390 | 39 | 149.50m | 1.08 |
| CD75-470K | 470 | 47 | 175.50m | 1.05 |
| CD75-560K | 560 | 56 | 208.00m | 930m |
| CD75-680K | 680 | 68 | 234.00m | 830m |
| CD75-820K | 820 | 82 | 273.00m | 780m |
| CD75-101K | 101 | 100 | 325.00m | 730m |
| CD75-121K | 121 | 120 | 390.00m | 650m |
| CD75-151K | 151 | 150 | 520.00m | 580m |
| CD75-181K | 181 | 180 | 598.00m | 510m |
| CD75-221K | 221 | 220 | 793.00m | 480m |
| CD75-271K | 271 | 270 | 884.00m | 400m |
| CD75-331K | 331 | 330 | 1.13 | 390m |
| CD75-391K | 391 | 390 | 1.30 | 350m |
| CD75-471K | 471 | 470 | 1.68 | 330m |
| CD75-561K | 561 | 560 | 1.90 | 300m |
| CD75-681K | 681 | 680 | 2.47 | 270m |
| CD75-821K | 821 | 820 | 2.86 | 250m |

1. Inductance tolerance: M: \pm 20%; K \pm 10%

2. Inductance measuring frequency: $L \leq 10\mu$ H at 100KHz/0.25V
 $L > 10\mu$ H at 1KHz/0.25v

3. Rated current: The DC current at which the inductance decreases to 90% of it's initial value or when $\Delta t = 40^\circ\text{C}$, whichever is lower ($T_a = 20^\circ\text{C}$).

Wound Ferrite SMD Inductor for Power Circuit-----CD Series

Operating Temp. : -40°C~125°C(including self-heating)

Electronic Characteristics List

| Part Name | Stamp | Inductance (μ H) [Within] | D.C.R. (Ω) [Max.] (20°C) | Rated Current (A) |
|------------|-------|--------------------------------------|---------------------------------------|----------------------|
| CD105-1R0M | 1R0 | 1.0 | 8.45m | 8.00 |
| CD105-1R4M | 1R4 | 1.4 | 13.78m | 6.80 |
| CD105-1R5M | 1R5 | 1.5 | 13.78m | 6.80 |
| CD105-1R8M | 1R8 | 1.8 | 15.60m | 6.50 |
| CD105-2R7M | 2R7 | 2.7 | 17.81m | 5.50 |
| CD105-3R3M | 3R3 | 3.3 | 19.50m | 5.00 |
| CD105-4R7M | 4R7 | 4.7 | 22.10m | 4.60 |
| CD105-5R6M | 5R6 | 5.6 | 23.79m | 4.00 |
| CD105-6R8M | 6R8 | 6.8 | 26.00m | 3.60 |
| CD105-8R2M | 8R2 | 8.2 | 31.20m | 3.20 |
| CD105-100K | 100 | 10 | 34.45m | 2.58 |
| CD105-120K | 120 | 12 | 40.30m | 2.44 |
| CD105-150K | 150 | 15 | 45.50m | 2.26 |
| CD105-180K | 180 | 18 | 48.49m | 2.13 |
| CD105-220K | 220 | 22 | 70.20m | 1.93 |
| CD105-270K | 270 | 27 | 84.11m | 1.74 |
| CD105-330K | 330 | 33 | 92.30m | 1.46 |
| CD105-390K | 390 | 39 | 124.80m | 1.36 |
| CD105-470K | 470 | 47 | 135.20m | 1.26 |
| CD105-560K | 560 | 56 | 158.60m | 1.15 |
| CD105-680K | 680 | 68 | 200.20m | 1.10 |
| CD105-820K | 820 | 82 | 230.10m | 980m |
| CD105-101K | 101 | 100 | 260.00m | 950m |
| CD105-121K | 121 | 120 | 351.00m | 870m |
| CD105-151K | 151 | 150 | 403.00m | 740m |
| CD105-181K | 181 | 180 | 494.00m | 700m |
| CD105-221K | 221 | 220 | 572.00m | 650m |
| CD105-271K | 271 | 270 | 728.00m | 540m |
| CD105-331K | 331 | 330 | 845.00m | 500m |
| CD105-391K | 391 | 390 | 1.04 | 460m |
| CD105-471K | 471 | 470 | 1.18 | 400m |
| CD105-561K | 561 | 560 | 1.42 | 300m |
| CD105-681K | 681 | 680 | 1.99 | 280m |
| CD105-821K | 821 | 820 | 2.03 | 240m |

1. Inductance tolerance: M: $\pm 20\%$; K $\pm 10\%$

2. Inductance measuring frequency: $L \leq 10\mu\text{H}$ at 100KHz/0.25V
 $L > 10\mu\text{H}$ at 1KHz/0.25v

3. Rated current: The DC current at which the inductance decreases to 90% of it's initial value or when $\Delta t = 40^\circ\text{C}$, whichever is lower($T_a = 20^\circ\text{C}$).

Wound Ferrite SMD Inductor for Power Circuit-----CDH6B Series

Operating Temp. : -40°C~125°C(including self-heating)



Feature

- Ferrite drum core construction.
- Magnetically shielded.
- Moisture Sensitivity Level: 1
- RoHS compliance.
- Halogen Free available.

Application

- Ideally used in Notebook PC, LCD TV, DVD, Game machine, STB, Projector etc as DC-DC converter inductors.

Production identification

CDH 6B38 6R8 M T

① ② ③ ④ ⑤

| |
|-------------|
| ① CDH |
| Series Name |

| |
|--------------------|
| ③ Inductance value |
| 6R8 -----> 6.8uH |
| 100-----> 10uH |

| |
|------------------------|
| ④ Inductance Tolerance |
| K-----> $\pm 10\%$ |
| M-----> $\pm 20\%$ |
| N-----> $\pm 30\%$ |

| | |
|---|-----------------|
| ② External Dimensions (L x W x H.) [Unit: mm] | |
| CDH6B28 | 7.0 x 7.0 x 3.0 |
| CDH6B38 | 7.0 x 7.0 x 4.0 |

| |
|-----------------------------|
| ⑤ Packing Type |
| T----> Tape Carrier Package |

※CDH6B Series

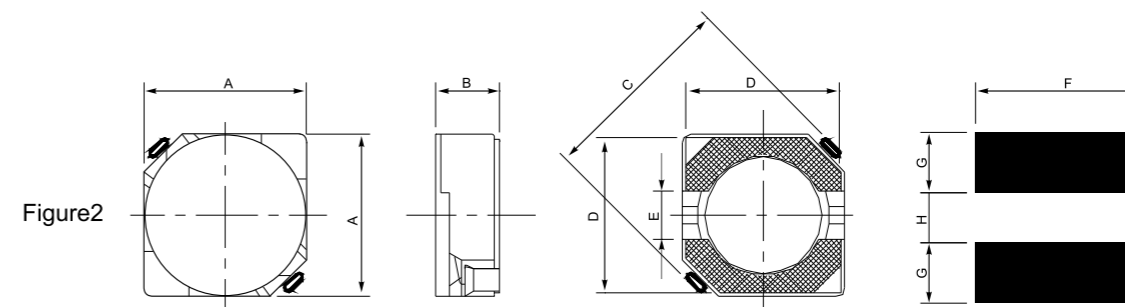

| TYPE | A(max) | B (max) | C(max) | D | E | F | G | H |
|---------|--------|----------|--------|------|------|------|------|------|
| CDH6B28 | 7.00 | 3.00 | 9.50 | 6.50 | 2.00 | 7.30 | 2.65 | 2.00 |
| CDH6B38 | 7.00 | 4.00 | 9.50 | 6.50 | 2.00 | 7.30 | 2.65 | 2.00 |

Wound Ferrite SMD Inductor for Power Circuit-----CDH6B Series

Operating Temp. : -40°C~125°C(including self-heating)

Electronic Characteristics List

| Part Name | L(H) | D.C.R(Ω) : MAX. | Rated Current (A)※3 |
|--------------|------|-----------------------------|------------------------|
| CDH6B28-1R0N | 1.0u | 18.2m | 3.60 |
| CDH6B28-1R8N | 1.8u | 20.8m | 3.45 |
| CDH6B28-2R2N | 2.2u | 24.7m | 3.15 |
| CDH6B28-2R7N | 2.7u | 27.3m | 2.84 |
| CDH6B28-3R3N | 3.3u | 29.9m | 2.80 |
| CDH6B28-3R9N | 3.9u | 32.5m | 2.60 |
| CDH6B28-4R7N | 4.7u | 40.3m | 2.30 |
| CDH6B28-5R6N | 5.6u | 45.5m | 2.13 |
| CDH6B28-6R8N | 6.8u | 46.8m | 1.88 |
| CDH6B28-8R2N | 8.2u | 55.9m | 1.73 |
| CDH6B28-100M | 10u | 75.4m | 1.60 |
| CDH6B28-120M | 12u | 80.6m | 1.50 |
| CDH6B28-150M | 15u | 89.7m | 1.34 |
| CDH6B28-180M | 18u | 93.6m | 1.21 |
| CDH6B28-220M | 22u | 122.2m | 1.10 |
| CDH6B28-270M | 27u | 131.3m | 1.02 |
| CDH6B28-330M | 33u | 159.9m | 918m |
| CDH6B28-390M | 39u | 195m | 835m |
| CDH6B28-470M | 47u | 234m | 745m |
| CDH6B28-560M | 56u | 273m | 685m |
| CDH6B28-680M | 68u | 364m | 607m |
| CDH6B28-820M | 82u | 403m | 570m |
| CDH6B28-101M | 100u | 507m | 520m |
| CDH6B28-121M | 120u | 676m | 450m |
| CDH6B28-151M | 150u | 806m | 410m |
| CDH6B28-181M | 180u | 949m | 380m |
| CDH6B28-221M | 220u | 1.11 | 350m |
| CDH6B28-271M | 270u | 1.56 | 310m |
| CDH6B28-331M | 330u | 1.70 | 285m |
| CDH6B28-391M | 390u | 1.95 | 253m |
| CDH6B28-471M | 470u | 2.73 | 230m |
| CDH6B28-561M | 560u | 2.99 | 220m |
| CDH6B28-681M | 680u | 3.51 | 193m |

1. Inductance tolerance: M: $\pm 20\%$; N: $\pm 30\%$

2. Inductance measuring frequency: $L \leq 10\mu\text{H}$ at 100KHz/0.25V
 $L > 10\mu\text{H}$ at 1KHz/0.25v

3. Rated current: The DC current at which the inductance decreases to 65% of it's initial value or when $\Delta t = 40^\circ\text{C}$, whichever is lower($T_a = 20^\circ\text{C}$).

Wound Ferrite SMD Inductor for Power Circuit-----CDH6B Series

Operating Temp. : -40°C~125°C(including self-heating)

Electronic Characteristics List

| Part Name | L(H) | D.C.R(Ω) : MAX. | Rated Current (A)※3 |
|-------------|------|-----------------------------|------------------------|
| CDH6B38-1R0 | 1.0u | 19.5m | 5.00 |
| CDH6B38-1R8 | 1.8u | 23.4m | 3.90 |
| CDH6B38-2R7 | 2.7u | 28.6m | 3.40 |
| CDH6B38-3R3 | 3.3u | 33.8m | 2.95 |
| CDH6B38-3R9 | 3.9u | 36.4m | 2.90 |
| CDH6B38-4R7 | 4.7u | 37.7m | 2.88 |
| CDH6B38-5R6 | 5.6u | 41.6m | 2.61 |
| CDH6B38-6R8 | 6.8u | 49.4m | 2.39 |
| CDH6B38-8R2 | 8.2u | 54.6m | 2.07 |
| CDH6B38-100 | 10u | 63.7m | 2.00 |
| CDH6B38-120 | 12u | 78.0m | 1.94 |
| CDH6B38-150 | 15u | 87.1m | 1.60 |
| CDH6B38-180 | 18u | 106.6m | 1.44 |
| CDH6B38-220 | 22u | 113.1m | 1.30 |
| CDH6B38-270 | 27u | 130.0m | 1.20 |
| CDH6B38-330 | 33u | 143.0m | 1.07 |
| CDH6B38-390 | 39u | 163.8m | 1.00 |
| CDH6B38-470 | 47u | 182m | 950m |
| CDH6B38-560 | 56u | 221m | 850m |
| CDH6B38-680 | 68u | 234m | 750m |
| CDH6B38-750 | 75u | 286m | 720m |
| CDH6B38-820 | 82u | 324m | 700m |
| CDH6B38-101 | 100u | 358m | 630m |
| CDH6B38-121 | 120u | 442m | 605m |
| CDH6B38-151 | 150u | 572m | 513m |
| CDH6B38-181 | 180u | 637m | 486m |
| CDH6B38-221 | 220u | 936m | 427m |
| CDH6B38-271 | 270u | 1.00 | 387m |
| CDH6B38-331 | 330u | 1.20 | 350m |
| CDH6B38-391 | 390u | 1.30 | 318m |
| CDH6B38-471 | 470u | 1.95 | 294m |
| CDH6B38-561 | 560u | 2.34 | 260m |
| CDH6B38-681 | 680u | 2.47 | 230m |

1. Inductance tolerance: M: $\pm 20\%$; N: $\pm 30\%$

2. Inductance measuring frequency: $L \leq 10\mu\text{H}$ at 100KHz/0.25V
 $L > 10\mu\text{H}$ at 1KHz/0.25v

3. Rated current: The DC current at which the inductance decreases to 65% of it's initial value or when $\Delta t = 40^\circ\text{C}$, whichever is lower($T_a = 20^\circ\text{C}$).

Wound Ferrite SMD Inductor for Power Circuit-----CDH8B Series

Operating Temp. : -40°C~125°C(including self-heating)



Feature

- Ferrite drum core construction
- Magnetically shielded
- Moisture Sensitivity Level: 1
- RoHS compliance
- Halogen Free available

Application

- Ideally used in Mobile phone, MP3, PDA ,HDD,DSC/DVC, etc as DC-DC converter inductors

Production identification

CDH 8B43 6R8 M T

① ② ③ ④ ⑤

| |
|------------------------|
| ① CDH |
| Series Name |
| ③ Inductance value |
| 6R8 -----> 6.8uH |
| 100----->10uH |
| ④ Inductance Tolerance |
| K-----> ± 10% |
| M-----> ± 20% |
| N-----> ± 30% |

| | |
|---|-----------------|
| ② External Dimensions (L × W × H.) [Unit: mm] | |
| CDH8B28B | 8.3 × 8.3 × 3.0 |
| CDH8B38B | 8.3 × 8.3 × 4.0 |
| CDH8B43B | 8.3 × 8.3 × 4.5 |

| |
|----------------------------|
| ⑤ Packing Type |
| T---->Tape Carrier Package |

※CDH8B Series

Dimensions and Land Patterns
(UNIT: mm)

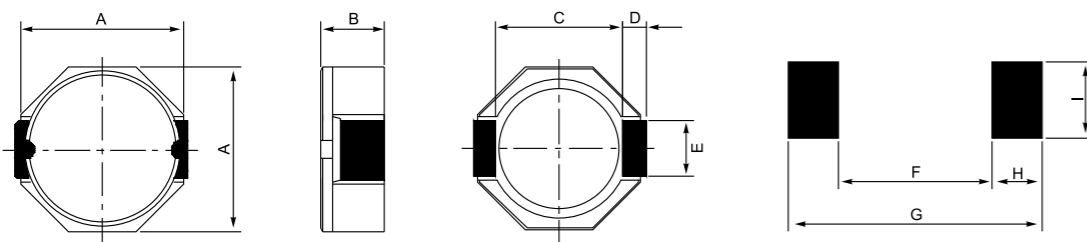

| Series | A | B | C | D | E (Ref) | F (Ref) | G (Ref) | H (Ref) | I (Ref) |
|----------|------|------|------|------|---------|---------|---------|---------|---------|
| CDH8B28B | 8.30 | 3.00 | 5.90 | 1.20 | 2.50 | 6.10 | 10.10 | 2.00 | 2.80 |
| CDH8B38B | 8.30 | 4.00 | 5.90 | 1.20 | 2.50 | 6.10 | 10.10 | 2.00 | 2.80 |
| CDH8B43B | 8.30 | 4.50 | 5.90 | 1.20 | 2.50 | 6.10 | 10.10 | 2.00 | 2.80 |

Wound Ferrite SMD Inductor for Power Circuit-----CDH8B Series

Operating Temp. : -40°C~125°C(including self-heating)

Electronic Characteristics List

| Part Name | L(H) | D.C.R(Ω) : MAX. | Rated Current (A)※1 |
|---------------|------|--------------------|------------------------|
| CDH8B28B-2R5N | 2.5u | 26.00m | 4.13 |
| CDH8B28B-3R3N | 3.3u | 32.50m | 3.70 |
| CDH8B28B-3R9N | 3.9u | 58.50m | 3.00 |
| CDH8B28B-4R7N | 4.7u | 62.00m | 2.60 |
| CDH8B28B-6R8N | 6.8u | 85.00m | 2.50 |
| CDH8B28B-100M | 10u | 91.00m | 2.50 |
| CDH8B28B-150M | 15u | 137.00m | 1.61 |
| CDH8B28B-220M | 22u | 195.00m | 1.40 |
| CDH8B28B-330M | 33u | 319.00m | 1.16 |
| CDH8B28B-470M | 47u | 423.00m | 900m |
| CDH8B28B-680M | 68u | 559.00m | 750m |
| CDH8B28B-101M | 100u | 793.00m | 580m |
| CDH8B28B-121M | 120u | 935.00m | 510m |
| CDH8B28B-151M | 150u | 1.09 | 470m |
| CDH8B28B-181M | 180u | 1.65 | 420m |
| CDH8B28B-221M | 220u | 1.82 | 400m |
| CDH8B28B-331M | 330u | 2.0 | 330m |
| CDH8B38B-2R2N | 2.2u | 20m | 5.40 |
| CDH8B38B-3R9N | 3.9u | 29m | 4.30 |
| CDH8B38B-6R8N | 6.8u | 36m | 3.00 |
| CDH8B38B-100M | 10u | 49m | 2.70 |
| CDH8B38B-150M | 15u | 75m | 2.30 |
| CDH8B38B-220M | 22u | 109m | 1.88 |
| CDH8B38B-330M | 33u | 163m | 1.52 |
| CDH8B38B-470M | 47u | 211m | 1.28 |
| CDH8B38B-680M | 68u | 304m | 1.10 |
| CDH8B38B-101M | 100u | 416m | 880m |
| CDH8B38B-121M | 120u | 494m | 830m |
| CDH8B38B-151M | 150u | 598m | 780m |
| CDH8B38B-181M | 180u | 780m | 700m |
| CDH8B38B-221M | 220u | 910m | 636m |
| CDH8B38B-271M | 270u | 1.1 | 550m |
| CDH8B43B-1R8N | 1.8u | 16.00m | 5.15 |
| CDH8B43B-2R5N | 2.5u | 20.00m | 5.00 |
| CDH8B43B-3R3N | 3.3u | 22.00m | 4.50 |
| CDH8B43B-3R9N | 3.9u | 22.00m | 4.50 |
| CDH8B43B-4R7N | 4.7u | 30.00m | 4.0 |
| CDH8B43B-6R8N | 6.8u | 33.00m | 3.87 |
| CDH8B43B-100M | 10u | 44.00m | 3.10 |
| CDH8B43B-150M | 15u | 75.00m | 2.35 |
| CDH8B43B-220M | 22u | 82.00m | 1.90 |
| CDH8B43B-330M | 33u | 125.00m | 1.62 |
| CDH8B43B-470M | 47u | 176.00m | 1.35 |
| CDH8B43B-680M | 68u | 247.00m | 1.20 |
| CDH8B43B-101M | 100u | 377.00m | 1.02 |
| CDH8B43B-121M | 120u | 429.00m | 900m |
| CDH8B43B-151M | 150u | 520.00m | 830m |
| CDH8B43B-181M | 180u | 624.00m | 785m |
| CDH8B43B-221M | 220u | 793.00m | 685m |
| CDH8B43B-271M | 270u | 962.00m | 620m |
| CDH8B43B-331M | 330u | 1.23 | 540m |

1. Inductance tolerance: M: ± 20%; N: ± 30%

2. Inductance measuring frequency: L ≤ 10uH at 100KHz/0.25V
L > 10uH at 1KHz/0.25V

3. Rated current: The DC current at which the inductance decreases to 65% of its initial value or when Δt=40°C, whichever is lower (Ta=20°C).

Wound Ferrite SMD Inductor for Power Circuit-----CDH10*R Series

Operating Temp. : -40°C~125°C(including self-heating)



Feature

- Ferrite drum core construction.
- Magnetically shielded.
- Moisture Sensitivity Level: 1
- RoHS compliance.
- Halogen Free available.

Application

- Ideally used in Notebook PC, LCD TV,DVD,Game machine, STB ,Projector etc as DC-DC converter inductors.

Production identification

CDH 103R 6R8 M T

① ② ③ ④ ⑤

| |
|------------------------|
| ① CDH |
| Series Name |
| ③ Inductance value |
| 6R8 -----> 6.8uH |
| 100----->10uH |
| ④ Inductance Tolerance |
| M-----> ± 20% |
| N-----> ± 30% |

| | |
|---|-------------------|
| ② External Dimensions (L x W x H.) [Unit: mm] | |
| CDH103R | 10.5 × 10.5 × 3.1 |
| CDH104R | 10.5 × 10.5 × 4.0 |
| CDH105R | 10.5 × 10.5 × 5.1 |

| |
|----------------------------|
| ⑤ Packing Type |
| T---->Tape Carrier Package |

※CDH10*R Series

Dimensions and Land Patterns
(UNIT: mm)

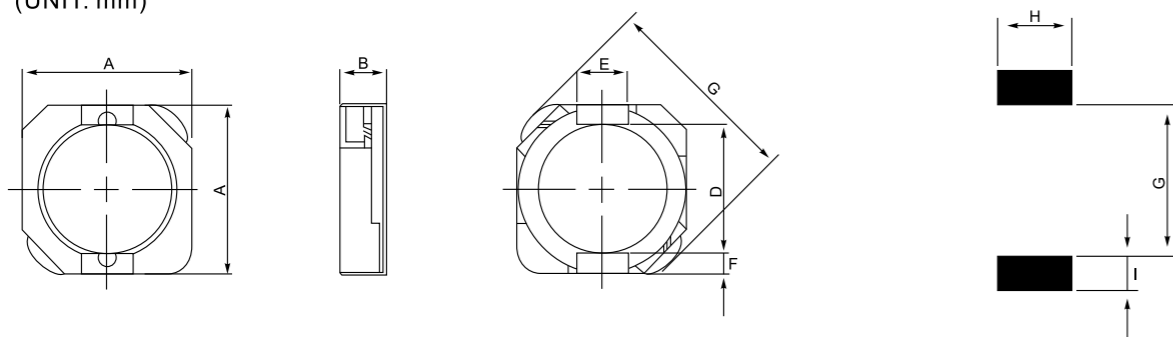

| Series | A | B | C | D | E (Ref) | F (Ref) | G (Ref) | H (Ref) | I (Ref) |
|---------|-------|------|-------|------|---------|---------|---------|---------|---------|
| CDH103R | 10.50 | 3.10 | 13.50 | 7.70 | 3.00 | 1.20 | 7.30 | 3.20 | 1.60 |
| CDH104R | 10.50 | 4.00 | 13.50 | 7.70 | 3.00 | 1.20 | 7.30 | 3.20 | 1.60 |
| CDH105R | 10.50 | 5.10 | 13.50 | 7.70 | 3.00 | 1.20 | 7.30 | 3.20 | 1.60 |

Wound Ferrite SMD Inductor for Power Circuit-----CDH10*R Series

Operating Temp. : -40°C~125°C(including self-heating)

Electronic Characteristics List

| Part Name | L(H) | D.C.R(Ω) : MAX. | Rated Current (A)※3 |
|-------------|------|--------------------|------------------------|
| CDH103R-1R2 | 1.2u | 12m(9m) | 4.80 |
| CDH103R-1R8 | 1.8u | 14m(11m) | 4.50 |
| CDH103R-2R7 | 2.7u | 18m(14m) | 4.10 |
| CDH103R-3R9 | 3.9u | 22m(17m) | 3.76 |
| CDH103R-6R8 | 6.8u | 36m(28m) | 3.10 |
| CDH103R-8R2 | 8.2u | 42m(32m) | 3.00 |
| CDH103R-100 | 10u | 52m(40m) | 2.80 |
| CDH103R-150 | 15u | 62m(48m) | 2.10 |
| CDH103R-220 | 22u | 91m(70m) | 1.80 |
| CDH103R-330 | 33u | 150m(115m) | 1.53 |
| CDH103R-470 | 47u | 208m(160m) | 1.34 |
| CDH103R-560 | 56u | 228m(175m) | 1.19 |
| CDH103R-680 | 68u | 289m(222m) | 1.13 |
| CDH103R-820 | 82u | 312m(240m) | 1.04 |
| CDH103R-101 | 100u | 377m(290m) | 960m |
| CDH103R-121 | 120u | 449m(345m) | 882m |
| CDH103R-151 | 150u | 607m(467m) | 747m |
| CDH103R-181 | 180u | 676m(520m) | 688m |
| CDH103R-221 | 220u | 826(635m) | 666m |
| CDH103R-271 | 270u | 933(718m) | 580m |
| CDH103R-331 | 330u | 1.14(880m) | 513m |
| CDH103R-391 | 390u | 1.43(1.10) | 490m |
| CDH103R-471 | 470u | 1.61(1.24) | 450m |
| CDH104R-1R2 | 1.2u | 12m(9.5m) | 5.40 |
| CDH104R-2R2 | 2.2u | 17m(13m) | 4.95 |
| CDH104R-3R3 | 3.3u | 22m(17m) | 4.35 |
| CDH104R-3R9 | 3.9u | 26m(20m) | 4.05 |
| CDH104R-5R6 | 5.6u | 33(25m) | 3.80 |
| CDH104R-100 | 10u | 60m(46m) | 3.15 |
| CDH104R-150 | 15u | 78m(60m) | 2.90 |
| CDH104R-220 | 22u | 107m(82m) | 2.50 |
| CDH104R-330 | 33u | 133m(102m) | 2.00 |
| CDH104R-470 | 47u | 241m(185m) | 1.80 |
| CDH104R-560 | 56u | 260m(200m) | 1.62 |
| CDH104R-680 | 68u | 338m(260m) | 1.35 |
| CDH104R-820 | 82u | 384m(295m) | 1.26 |
| CDH104R-101 | 100u | 429m(330m) | 1.17 |
| CDH104R-151 | 150u | 611m(470m) | 1.05 |
| CDH104R-221 | 220u | 939m(722m) | 900m |
| CDH104R-271 | 270u | 1.17(900m) | 720m |
| CDH104R-331 | 330u | 1.30(1.00) | 530m |
| CDH104R-391 | 390u | 1.56(1.20) | 450m |
| CDH104R-471 | 470u | 1.76(1.35) | 405m |

1. Inductance tolerance: M: ± 20%; N: ± 30%

2. Inductance measuring frequency: L ≤ 10uH at 100KHz/0.25V
L > 10uH at 1KHz/0.25V

3. Rated current: The DC current at which the inductance decreases to 65% of its initial value or when Δt=40°C, whichever is lower(Ta=20°C).

Wound Ferrite SMD Inductor for Power Circuit-----CDH10*R Series

Operating Temp. : -40°C~125°C(including self-heating)

Electronic Characteristics List

| Part Name | L(H) | D.C.R(Ω) : MAX. | Rated Current (A)※3 |
|-------------|------|-----------------------------|------------------------|
| CDH105R-1R2 | 1.2u | 12.00m | 8.30 |
| CDH105R-1R5 | 1.5u | 14.00m | 8.30 |
| CDH105R-2R2 | 2.2u | 16.00m | 7.50 |
| CDH105R-3R3 | 3.3u | 19.50m | 6.50 |
| CDH105R-4R7 | 4.7u | 28.00m | 5.50 |
| CDH105R-5R6 | 5.6u | 30.00m | 4.50 |
| CDH105R-6R8 | 6.8u | 36.00m | 4.90 |
| CDH105R-100 | 10u | 51.00m | 4.00 |
| CDH105R-150 | 15u | 57.00m | 3.30 |
| CDH105R-180 | 18u | 59.00m | 3.10 |
| CDH105R-220 | 22u | 82.00m | 2.90 |
| CDH105R-330 | 33u | 95.00m | 2.60 |
| CDH105R-470 | 47u | 183.00m | 2.00 |
| CDH105R-560 | 56u | 205.00m | 1.80 |
| CDH105R-680 | 68u | 234.00m | 1.60 |
| CDH105R-820 | 82u | 247.00m | 1.40 |
| CDH105R-101 | 100u | 325.00m | 1.35 |
| CDH105R-151 | 150u | 403.00m | 1.10 |
| CDH105R-181 | 180u | 527.00m | 1.00 |
| CDH105R-221 | 220u | 658.00m | 940m |
| CDH105R-331 | 330u | 775.00m | 600m |
| CDH105R-471 | 470u | 1.30 | 540m |

1. Inductance tolerance: M: $\pm 20\%$; N: $\pm 30\%$

2. Inductance measuring frequency: $L \leq 10\mu\text{H}$ at 100KHz/0.25V
 $L > 10\mu\text{H}$ at 1KHz/0.25v

3. Rated current: The DC current at which the inductance decreases to 65% of it's initial value or when $\Delta t = 40^\circ\text{C}$, whichever is lower($T_a = 20^\circ\text{C}$).

Wound Ferrite SMD Inductor for Power Circuit-----12 Series

Operating Temp. : -40°C~125°C(including self-heating)



Feature

- Ferrite drum core construction.
- Magnetically shielded.
- Moisture Sensitivity Level: 1
- RoHS compliance.
- Halogen Free available.

Application

- Ideally used in Notebook PC, LCD TV, DVD, Game machine, STB, Projector etc. as DC-DC converter inductors.

Production identification

CDH 124 6R8 M T

① ② ③ ④ ⑤

| |
|-------------|
| ① CDH |
| Series Name |

| |
|--------------------|
| ③ Inductance Value |
| 6R8 -----> 6.8uH |
| 100-----> 10uH |

| |
|------------------------|
| ④ Inductance Tolerance |
| M-----> $\pm 20\%$ |
| N-----> $\pm 30\%$ |

| | |
|---|-------------------|
| ② External Dimensions (L x W x H.) [Unit: mm] | |
| CDH124 | 12.3 x 12.3 x 4.5 |
| CDH125 | 12.3 x 12.3 x 6.0 |
| CDH127 | 12.3 x 12.3 x 8.0 |

| |
|-----------------------------|
| ⑤ Packing Type |
| T----> Tape Carrier Package |

※CDH12 Series

Dimensions and Land Patterns.

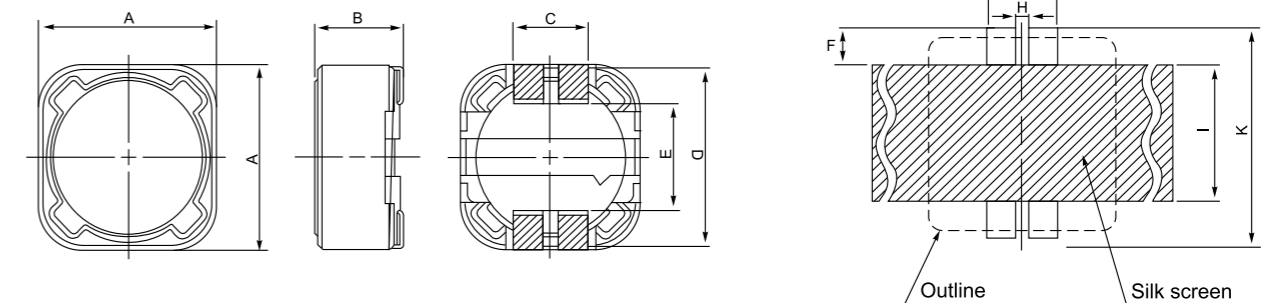

| Series | A | B | C | D | E (Ref) | F (Ref) | G (Ref) | H (Ref) | I (Ref) | K (Ref) |
|--------|-------|------|------|-------|---------|---------|---------|---------|---------|---------|
| CDH124 | 12.30 | 4.50 | 5.00 | 12.00 | 7.60 | 2.80 | 5.40 | 0.50 | 7.00 | 12.80 |
| CDH125 | 12.30 | 6.00 | 5.00 | 12.00 | 7.60 | 2.80 | 5.40 | 0.50 | 7.00 | 12.80 |
| CDH127 | 12.30 | 8.00 | 5.00 | 12.00 | 7.60 | 2.80 | 5.40 | 0.50 | 7.00 | 12.80 |

Wound Ferrite SMD Inductor for Power Circuit-----12 Series

Operating Temp. : -40°C~125°C(including self-heating)

Electronic Characteristics List

| Part Name | L(H) | D.C.R(Ω) : MAX. | Rated Current (A)※3 |
|-------------|-------|--------------------|------------------------|
| CDH124-1R0N | 1.0u | 8m(6m) | 7.80 |
| CDH124-1R5N | 1.5u | 11m(8.8m) | 7.20 |
| CDH124-2R2N | 2.2u | 13m(10m) | 6.00 |
| CDH124-3R3N | 3.3u | 18m(14m) | 5.40 |
| CDH124-3R9N | 3.9u | 21m(16m) | 5.10 |
| CDH124-4R7N | 4.7u | 22m(17m) | 4.80 |
| CDH124-5R6N | 5.6u | 23m(18m) | 4.30 |
| CDH124-6R8N | 6.8u | 26m(20m) | 4.20 |
| CDH124-8R2N | 8.2u | 31m(24m) | 4.00 |
| CDH124-100M | 10u | 39m(30m) | 3.90 |
| CDH124-120M | 12u | 44m(34m) | 3.40 |
| CDH124-150M | 15u | 55m(42m) | 3.20 |
| CDH124-180M | 18u | 65m(50) | 2.90 |
| CDH124-220M | 22u | 75m(58m) | 2.50 |
| CDH124-270M | 27u | 86m(66m) | 2.25 |
| CDH124-330M | 33u | 112m(86m) | 2.00 |
| CDH124-390M | 39u | 121m(93m) | 1.90 |
| CDH124-470M | 47u | 166m(128m) | 1.80 |
| CDH124-560M | 56u | 182m(140m) | 1.70 |
| CDH124-680M | 68u | 205m(158m) | 1.55 |
| CDH124-820M | 82u | 243m(187m) | 1.35 |
| CDH124-101M | 100u | 299m(230m) | 1.20 |
| CDH124-121M | 120u | 358m(275m) | 1.10 |
| CDH124-151M | 150u | 462m(355m) | 950m |
| CDH124-181M | 180u | 507m(390m) | 850m |
| CDH124-221M | 220u | 663m(510m) | 800m |
| CDH124-271M | 270u | 741m(570m) | 650m |
| CDH124-331M | 330u | 936m(720m) | 550m |
| CDH124-391M | 390u | 1.05(810m) | 500m |
| CDH124-471M | 470u | 1.30(1.00) | 440m |
| CDH124-561M | 560u | 1.53(1.18) | 400m |
| CDH124-681M | 680u | 1.72(1.32) | 370m |
| CDH124-821M | 820u | 2.21(1.70) | 350m |
| CDH124-102M | 1000u | 2.67(2.05) | 320m |
| CDH125-1R0N | 1.0u | 11.00m | 8.50 |
| CDH125-2R2N | 2.2u | 15.50m | 6.50 |
| CDH125-3R3N | 3.3u | 18.00m | 5.70 |
| CDH125-4R7N | 4.7u | 20.50m | 4.70 |
| CDH125-5R6N | 5.6u | 21.00m | 4.70 |
| CDH125-6R8N | 6.8u | 14.30m | 4.40 |
| CDH125-100M | 10u | 25.00m | 4.00 |
| CDH125-120M | 12u | 27.00m | 3.50 |
| CDH125-150M | 15u | 30.00m | 3.30 |
| CDH125-180M | 18u | 38.40m | 3.00 |
| CDH125-220M | 22u | 46.00m | 2.80 |
| CDH125-270M | 27u | 52.00m | 2.30 |
| CDH125-330M | 33u | 70.00m | 2.10 |
| CDH125-390M | 39u | 76.00m | 2.00 |
| CDH125-470M | 47u | 85.00m | 1.80 |
| CDH125-560M | 56u | 110.00m | 1.70 |
| CDH125-680M | 68u | 120.00m | 1.50 |

Wound Ferrite SMD Inductor for Power Circuit-----12 Series

Operating Temp. : -40°C~125°C(including self-heating)

Electronic Characteristics List

| Part Name | L(H) | D.C.R(Ω) : MAX. | Rated Current (A)※3 |
|-------------|------|--------------------|------------------------|
| CDH125-820M | 82u | 162.00m | 1.40 |
| CDH125-101M | 100u | 170.00m | 1.30 |
| CDH125-121M | 120u | 206.00m | 1.10 |
| CDH125-151M | 150u | 280.00m | 1.00 |
| CDH125-181M | 180u | 310.00m | 900m |
| CDH125-221M | 220u | 350.00m | 800m |
| CDH125-271M | 270u | 440.00m | 750m |
| CDH125-331M | 330u | 570.00m | 680m |
| CDH125-391M | 390u | 685.00m | 650m |
| CDH125-471M | 470u | 905.00m | 580m |
| CDH125-561M | 560u | 1000.00m | 540m |
| CDH127-1R0N | 1.0u | 6.50m | 10.40 |
| CDH127-1R5N | 1.5u | 8.50m | 9.20 |
| CDH127-2R2N | 2.2u | 11.00m | 8.40 |
| CDH127-2R7N | 2.7u | 12.20m | 7.80 |
| CDH127-3R3N | 3.3u | 13.00m | 7.60 |
| CDH127-3R9N | 3.9u | 14.00m | 7.20 |
| CDH127-4R7N | 4.7u | 15.80m | 6.80 |
| CDH127-5R6N | 5.6u | 16.70m | 6.70 |
| CDH127-6R8N | 6.8u | 18.40m | 6.50 |
| CDH127-7R6N | 7.6u | 20.00m | 5.90 |
| CDH127-100M | 10u | 23.40m | 5.40 |
| CDH127-120M | 12u | 26.00m | 4.90 |
| CDH127-150M | 15u | 28.60m | 4.50 |
| CDH127-180M | 18u | 39.20m | 3.90 |
| CDH127-220M | 22u | 43.20m | 3.60 |
| CDH127-270M | 27u | 51.09m | 3.30 |
| CDH127-330M | 33u | 64.80m | 3.00 |
| CDH127-390M | 39u | 72.90m | 2.75 |
| CDH127-470M | 47u | 100.00m | 2.50 |
| CDH127-560M | 56u | 110.00m | 2.35 |
| CDH127-680M | 68u | 140.00m | 2.10 |
| CDH127-820M | 82u | 160.00m | 1.95 |
| CDH127-101M | 100u | 220.00m | 1.70 |
| CDH127-121M | 120u | 250.00m | 1.60 |
| CDH127-151M | 150u | 280.00m | 1.42 |
| CDH127-181M | 180u | 290.00m | 1.30 |
| CDH127-221M | 220u | 299.00m | 1.16 |
| CDH127-271M | 270u | 403.00m | 1.06 |
| CDH127-331M | 330u | 455.00m | 950m |
| CDH127-391M | 390u | 494.00m | 880m |
| CDH127-471M | 470u | 689.00m | 790m |
| CDH127-561M | 560u | 793.00m | 730m |

1. Inductance tolerance: M: ± 20%; N: ± 30%

2. Inductance measuring frequency: L≤10uH at 100KHz/0.25V
L>10uH at 1KHz/0.25v

3. Rated current: The DC current at which the inductance decreases to 65% of it's initial value or when Δt=40°C, whichever is lower(Ta=20°C).

Wound Ferrite SMD Inductor for Power Circuit-----BF Series

Operating Temp. : -40°C~125°C(including self-heating)



Feature

- Shielded construction
- Mn-Zn Ferrite core ,High DC Saturation Current
- 100% Pb lead(Pb) free meet RoHS standard

Application

- Ideal for Communication Power Supply.

Production identification

BF 1608 6R8 M T

① ② ③ ④ ⑤

| |
|------------------------|
| ① BF |
| Series Name |
| ③ Inductance value |
| 6R8 -----> 6.8uH |
| 100----->10uH |
| ④ Inductance Tolerance |
| M-----> ± 20% |
| N-----> ± 30% |

| | |
|---|--------------------|
| ② External Dimensions (L x W x H.) [Unit: mm] | |
| BF1608 | 6.9 × 4.5 × 2.9 |
| BF3316 | 13.5 × 10.0 × 51.0 |
| BF5022 | 19.0 × 14.3 × 7.1 |

| |
|----------------------------|
| ⑤ Packing Type |
| T---->Tape Carrier Package |

※BF Series

Dimensions and Land Patterns
(UNIT: mm)

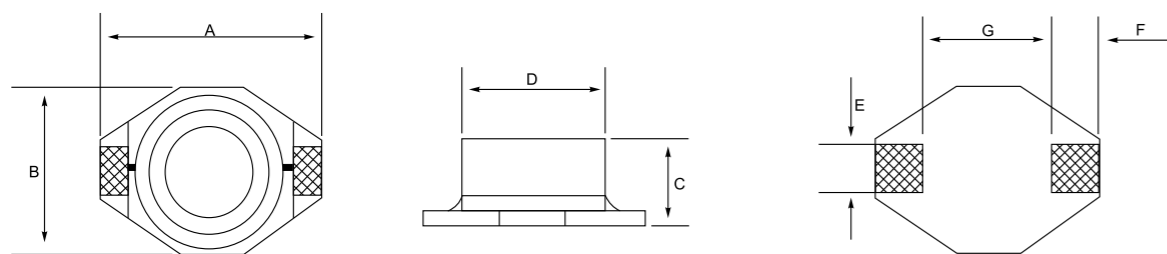

| TYPE | A(max) | B(max) | C(max) | D | E | F | G |
|--------|--------|--------|--------|-------|------|------|-------|
| BF1608 | 6.9 | 4.5 | 2.9 | 4.00 | 1.20 | 1.15 | 4.20 |
| BF3316 | 13.5 | 10.0 | 5.1 | 8.38 | 2.54 | 2.54 | 7.62 |
| BF5022 | 19.0 | 15.2 | 7.1 | 12.70 | 2.54 | 2.54 | 12.70 |

Wound Ferrite SMD Inductor for Power Circuit-----BF Series

Operating Temp. : -40°C~125°C(including self-heating)

Electronic Characteristics List

| Part Name | L(H) | D.C.R(Ω) : MAX. | Rated Current (A)※1 |
|--------------|-------|--------------------|------------------------|
| BF1608-1R0N | 1.0u | 16m(12m) | 1.50 |
| BF1608-1R5N | 1.5u | 18m(14m) | 1.18 |
| BF1608-2R2N | 2.2u | 23m(18m) | 1.08 |
| BF1608-3R3N | 3.3u | 29m(22m) | 800m |
| BF1608-4R7N | 4.7u | 46m(35m) | 600m |
| BF1608-6R8N | 6.8u | 60m(43m) | 560m |
| BF1608-100M | 10u | 80m(61m) | 400m |
| BF1608-150M | 15u | 102m(78m) | 330m |
| BF1608-220M | 22u | 128m(99m) | 300m |
| BF1608-330M | 33u | 169m(130m) | 270m |
| BF1608-470M | 47u | 228m(175m) | 220m |
| BF1608-680M | 68u | 332m(255m) | 170m |
| BF1608-101M | 100u | 520m(400m) | 140m |
| BF1608-151M | 150u | 800m(610m) | 110m |
| BF1608-221M | 220u | 1.08m(830m) | 90m |
| BF1608-331M | 330u | 1.56(1.20) | 67m |
| BF1608-471M | 470u | 2.20(1.70) | 54m |
| BF3316-1R5N | 1.5u | 23m(18m) | 3.80 |
| BF3316-3R3N | 3.3u | 35m(27m) | 2.50 |
| BF3316-4R7N | 4.7u | 44m(34m) | 2.10 |
| BF3316-6R8N | 6.8u | 57m(44m) | 2.00 |
| BF3316-100 M | 10u | 99m(76m) | 1.60 |
| BF3316-150M | 15u | 134m(103m) | 1.35 |
| BF3316-220M | 22u | 228m(175m) | 1.10 |
| BF3316-330M | 33u | 325m(250m) | 810m |
| BF3316-470M | 47u | 403m(310m) | 730m |
| BF3316-680M | 68u | 585m(450m) | 640m |
| BF3316-101M | 100u | 793m(610m) | 520m |
| BF3316-151M | 150u | 1.80(1.39m) | 430m |
| BF3316-221M | 220u | 2.15(1.65) | 340m |
| BF3316-331M | 330u | 2.67(2.05) | 270m |
| BF3316-471M | 470u | 3.90(3.00) | 190m |
| BF3316-681M | 680u | 5.85(4.50) | 170m |
| BF3316-102M | 1000u | 8.32(4.50) | 140m |
| BF5022-1R0N | 1.0u | 16m(12.5m) | 6.50 |
| BF5022-2R2N | 2.2u | 23m(18m) | 5.00 |
| BF5022-3R3N | 3.3u | 26m(20m) | 4.70 |
| BF5022-4R7N | 4.7u | 28m(22m) | 4.40 |
| BF5022-5R6N | 5.6u | 30m(23m) | 4.10 |
| BF5022-100M | 10u | 40m(31m) | 3.90 |
| BF5022-150M | 15u | 48m(37m) | 3.40 |
| BF5022-220M | 22u | 59m(45m) | 3.10 |
| BF5022-330M | 33u | 75m(58m) | 2.80 |
| BF5022-470M | 47u | 97m(75m) | 2.40 |
| BF5022-680M | 68u | 138(106m) | 2.00 |
| BF5022-101M | 100u | 207m(158m) | 1.70 |
| BF5022-151M | 150u | 293m(225m) | 1.30 |
| BF5022-221M | 220u | 470m(365m) | 1.10 |
| BF5022-331M | 330u | 780m(600m) | 860m |
| BF5022-471M | 470u | 1.08(830m) | 730m |

1. Inductance tolerance: M: ± 20%; N: ± 30%

2. Inductance measuring frequency: L ≤ 10uH at 100KHz/0.25V
L > 10uH at 1KHz/0.25v

3. Rated current: The DC current at which the inductance decreases to 65% of its initial value or when Δt=40°C, whichever is lower(Ta=20°C).

Wound Ferrite SMD Inductor for Power Circuit-----B Series

Operating Temp. : -40°C~125°C(including self-heating)



Feature

- Un-shielded construction
- Mn-Zn Ferrite core ,High DC Saturation Current
- 100% Pb lead(Pb) free meet RoHS standard

Application

- Ideal for Communication Power Supply.

Production identification

B 1608 6R8 M T
 ① ② ③ ④ ⑤

| |
|------------------------|
| ① B |
| Series Name |
| ③ Inductance value |
| 6R8 -----> 6.8uH |
| 100----->10uH |
| ④ Inductance Tolerance |
| M-----> ± 20% |
| N-----> ± 30% |

| | |
|---|--------------------|
| ② External Dimensions (L × W × H.) [Unit: mm] | |
| B1608 | 7.0 × 4.5 × 2.9 |
| B3316 | 13.5 × 10.0 × 5.5 |
| B3340 | 13.5 × 10.0 × 11.4 |
| B5022 | 19.0 × 14.3 × 7.1 |

| | |
|----------------|----------------------|
| ⑤ Packing Type | |
| T-----> | Tape Carrier Package |

※B Series

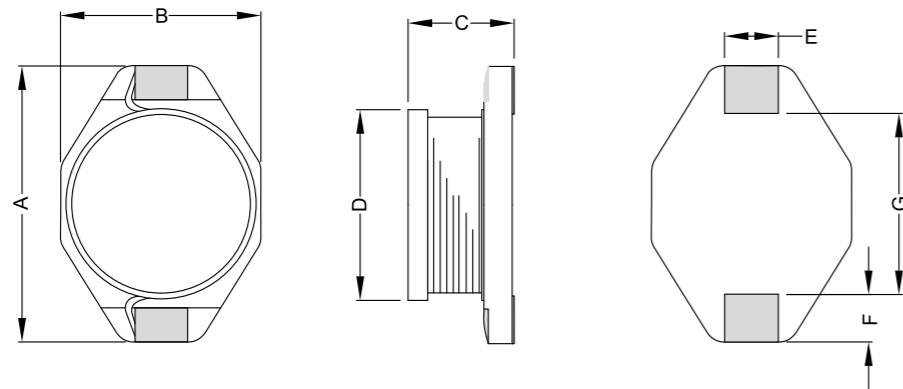

| TYPE | A(max) | B(max) | C(max) | D | E | F | G |
|-------|--------|--------|--------|-------|------|------|-------|
| B1608 | 7.0 | 4.5 | 2.9 | 4.00 | 1.20 | 1.15 | 4.20 |
| B3316 | 13.5 | 10.0 | 5.5 | 8.40 | 2.54 | 2.54 | 7.62 |
| B3340 | 13.5 | 10.0 | 11.4 | 8.40 | 2.54 | 2.54 | 7.62 |
| B5022 | 19.0 | 14.3 | 7.1 | 12.70 | 2.54 | 2.54 | 12.70 |

Wound Ferrite SMD Inductor for Power Circuit-----B Series

Operating Temp. : -40°C~125°C(including self-heating)

Electronic Characteristics List

| Part Name | L(H) | D.C.R(Ω) : MAX. | Rated Current (A)※3 |
|------------|-------|-----------------|---------------------|
| B1608-1R2M | 1.2u | 31m(24m) | 2.88 |
| B1608-1R5M | 1.5u | 34m(26m) | 2.70 |
| B1608-2R2M | 2.2u | 47m(36m) | 2.25 |
| B1608-3R3M | 3.3u | 65m(50m) | 1.75 |
| B1608-4R7M | 4.7u | 86m(66m) | 1.40 |
| B1608-6R8M | 6.8u | 117m(90m) | 1.30 |
| B1608-100K | 10u | 189m(145m) | 1.05 |
| B1608-150K | 15u | 286m(220m) | 810m |
| B1608-220K | 22u | 364m(280m) | 700m |
| B1608-330K | 33u | 650m(500m) | 530m |
| B1608-470K | 47u | 845m(650m) | 450m |
| B1608-680K | 68u | 1.12(860m) | 370m |
| B1608-101K | 100u | 1.66(1.28) | 310m |
| B1608-151K | 150u | 2.93(2.25) | 220m |
| B1608-221K | 220u | 3.90(3.00) | 180m |
| B1608-331K | 330u | 6.31(4.85) | 160m |
| B3316-1R2M | 1.2u | 8.5m(6.5m) | 6.10 |
| B3316-1R5M | 1.5u | 9m(7m) | 5.70 |
| B3316-2R2M | 2.2u | 12m(9m) | 5.00 |
| B3316-3R3M | 3.3u | 18m(14m) | 4.30 |
| B3316-3R9M | 3.9u | 20m(15m) | 4.00 |
| B3316-4R7M | 4.7u | 21m(16m) | 3.78 |
| B3316-5R6M | 5.6u | 25m(19m) | 3.70 |
| B3316-6R8M | 6.8u | 29m(22m) | 3.50 |
| B3316-8R2M | 8.2u | 31m(24m) | 3.40 |
| B3316-100K | 10u | 36m(28m) | 3.06 |
| B3316-150K | 15u | 56m(43m) | 2.80 |
| B3316-220K | 22u | 75m(58m) | 2.25 |
| B3316-270K | 27u | 91m(70m) | 1.98 |
| B3316-330K | 33u | 111m(85m) | 1.80 |
| B3316-390K | 39u | 121m(93m) | 1.71 |
| B3316-470K | 47u | 156m(120m) | 1.62 |
| B3316-560K | 56u | 178m(137m) | 1.50 |
| B3316-680K | 68u | 208m(160m) | 1.33 |
| B3316-820K | 82u | 260m(200m) | 1.21 |
| B3316-101K | 100u | 317m(244m) | 1.08 |
| B3316-151K | 150u | 471m(362m) | 900m |
| B3316-181K | 180u | 533m(410m) | 792m |
| B3316-221K | 220u | 663m(510m) | 720m |
| B3316-331K | 330u | 1.03(790m) | 600m |
| B3316-391K | 390u | 1.21(930m) | 550m |
| B3316-471K | 470u | 1.50(1.15) | 500m |
| B3316-561K | 560u | 1.70(1.30) | 405m |
| B3316-681K | 680u | 2.08(1.60) | 350m |
| B3316-821K | 820u | 2.50(1.91) | 300m |
| B3316-102K | 1000u | 3.12(2.40) | 270m |

1. Inductance tolerance: M: ± 20%; K ± 10%

2. Inductance measuring frequency: L ≤ 10uH at 100KHz/0.25V
 L > 10uH at 1KHz/0.25V

3. Rated current: The DC current at which the inductance decreases to 90% of its initial value or when Δt=40°C, whichever is lower(Ta=20°C).

Wound Ferrite SMD Inductor for Power Circuit-----B Series

Operating Temp. : -40°C~125°C(including self-heating)

Electronic Characteristics List

| Part Name | L(H) | D.C.R(Ω) : MAX. | Rated Current (A)※3 |
|------------|-------|-----------------------------|------------------------|
| B3340-1R0N | 1.0u | 7.7m(4m) | 9.80 |
| B3340-1R2N | 1.2u | 10m(6m) | 9.00 |
| B3340-1R5N | 1.5u | 12m(6.5m) | 8.50 |
| B3340-3R3N | 3.3u | 14.3m(10m) | 7.00 |
| B3340-4R7N | 4.7u | 15.6m(11m) | 6.50 |
| B3340-6R8N | 6.8u | 17m(13m) | 6.00 |
| B3340-100M | 10u | 30m(23m) | 4.10 |
| B3340-150M | 15u | 36m(28m) | 3.80 |
| B3340-220M | 22u | 52m(40m) | 3.00 |
| B3340-330M | 33u | 70m(54m) | 2.50 |
| B3340-470M | 47u | 99m(76m) | 2.00 |
| B3340-680M | 68u | 144m(111m) | 1.70 |
| B3340-101M | 100u | 182m(140m) | 1.35 |
| B3340-151M | 150u | 334m(257m) | 1.10 |
| B3340-221M | 220u | 436m(335m) | 1.00 |
| B3340-331M | 330u | 689m(530m) | 765m |
| B3340-471M | 470u | 1.00(770m) | 600m |
| B3340-681M | 680u | 1.43(1.10) | 495m |
| B3340-102M | 1000u | 2.08(1.60) | 430m |
| B5022-1R5N | 1.5u | 7m(5m) | 8.50 |
| B5022-2R2N | 2.2u | 8m(6m) | 7.20 |
| B5022-3R3N | 3.3u | 13m(10m) | 6.30 |
| B5022-5R6N | 5.6u | 20m(15m) | 5.30 |
| B5022-6R8N | 6.8u | 21m(16m) | 4.90 |
| B5022-100M | 10u | 23m(18m) | 4.30 |
| B5022-150M | 15u | 33m(25m) | 3.85 |
| B5022-220M | 22u | 52m(40m) | 3.15 |
| B5022-330M | 33u | 75m(58m) | 2.50 |
| B5022-470M | 47u | 98m(75m) | 2.10 |
| B5022-560M | 56u | 105m(81m) | 2.00 |
| B5022-680M | 68u | 120m(92m) | 1.80 |
| B5022-101M | 100u | 218m(168m) | 1.35 |
| B5022-151M | 150u | 317m(244m) | 1.15 |
| B5022-221M | 220u | 433m(333m) | 1.00 |
| B5022-331M | 330u | 644m(495m) | 810m |
| B5022-471M | 470u | 932m(717m) | 675m |
| B5022-561M | 560u | 1.16(892m) | 585m |
| B5022-681M | 680u | 1.47(1.13) | 530m |
| B5022-102M | 1000u | 2.05(1.58) | 440m |

※ 测试条件: $L \leq 8.2\mu\text{H}$ 测试频率100KHz / 0.25V, (M \pm 20%);

$L > 8.2\mu\text{H}$ 测试频率1KHz / 0.25V, (K \pm 10%);

※ 测试仪表: HP4291B、502BC、CH1062。

Ultra-small SMD Wound Ferrite Common Mode Choke---CM/PCM/TCM Series

Operating Temp. : -25°C~85°C ; Storage Temp. and Humidity : -25°C~85°C , 70%RH max.

Feature

- Winding type realizes small size and low profile
- Prevention of common mode noise at high frequency
- Ideal for different noise level and signal frequency
- Excellent solder ability

Application

- CM Series : Used in USB/DVI/HDMI/USB3.0/DP PORT
A Type : USB2.0/IEEE1394 for normal speed
C Type : C TYPE : DVI/HDMI1.4/Display-Port(DP) for Ultra-speed.
D Type : USB3.0 / DP-II for Ultra-speed.
- PCM Series : Used in DC Power Supply input for filter
- TCM Series : Used in LAN Port(RJ45) filter
- CF Series : Used in Vehicle electronic for EMI

Production identification

CM 0806 D 350 S

① ② ③ ④ ⑤

CM ①
Product Name

D ③
Classification
D: USB3.0/7.5GHz

350 ④
Impedance value
350 : 35 Ω at 100MHz

| External Dimensions {L x W x H[max.]} [Unit: mm] | |
|--|--------------------|
| 0806 | 0.85 x 0.65 x 0.45 |
| 1210 | 1.20 x 1.00 x 0.90 |
| 1608 | 1.60 x 0.80 x 1.20 |
| 2012 | 2.00 x 1.20 x 1.40 |
| 3216 | 3.20 x 1.60 x 2.10 |

| S ⑤ |
|---------------|
| Tolerance |
| M : \pm 20% |
| S : \pm 25% |

※CM series

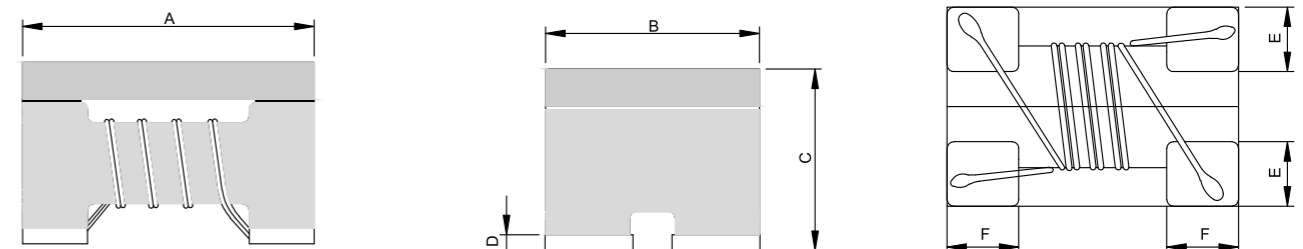

| Series | A | B | C | D(max.) | E (Typ.) | F (Typ.) |
|--------|----------------|----------------|---------------|---------------|----------|----------|
| 0806 | 0.85 \pm 0.1 | 0.65 \pm 0.1 | 0.45 max. | 0.15 max. | 0.27 | 0.22 |
| 1210 | 1.2 \pm 0.2 | 1.0 \pm 0.2 | 0.9 max. | 0.15 max. | 0.36 | 0.33 |
| 1608 | 1.6 \pm 0.1 | 0.8 \pm 0.1 | 1.1 \pm 0.1 | 0.1 \pm 0.1 | 0.25 | 0.33 |
| 2012 | 2.0 \pm 0.2 | 1.2 \pm 0.2 | 1.2 \pm 0.2 | 0.2 \pm 0.1 | 0.40 | 0.45 |
| 3216 | 3.2 \pm 0.2 | 1.6 \pm 0.2 | 1.9 \pm 0.2 | 0.2 \pm 0.1 | 0.60 | 0.60 |

Ultra-small SMD Wound Ferrite Common Mode Choke---CM/PCM/TCM Series

Operating Temp. : -25°C~85°C ; Storage Temp. and Humidity : -25°C~85°C , 70%RH max.

Electrical Characteristics

| Part No. | Common Impedance Z(Ω) at 100MHz | DCR (Ω) | Rate Current Max.(mA) | Rate Voltage Typ.(V) | Insulation Resistance (MΩ) | Cut-off Frequency (Ghz) | Characteristic Resistance Typ. (Ω) |
|--------------|---------------------------------|---------|-----------------------|----------------------|----------------------------|-------------------------|------------------------------------|
| CM0806D-350□ | 35 | 0.55 | 100 | 10 | 10 | 7.5 | - |
| CM0806D-650□ | 65 | 0.80 | 100 | 10 | 10 | 7.5 | - |
| CM0806D-900□ | 90 | 1.00 | 100 | 10 | 10 | 7.5 | - |
| CM1210A-161□ | 160 | 0.60 | 260 | 20 | 10 | 1.0 | - |
| CM1210A-221□ | 220 | 0.70 | 230 | 20 | 10 | 1.0 | - |
| CM1210A-331□ | 330 | 0.80 | 200 | 20 | 10 | 1.0 | - |
| CM1210B-900□ | 90 | 0.50 | 280 | 20 | 10 | 3.5 | 90 |
| CM1210C-121□ | 120 | 0.55 | 270 | 20 | 10 | 6.0 | 90 |
| CM1210D-250□ | 25 | 0.30 | 300 | 20 | 10 | 7.5 | 90 |
| CM1210D-600□ | 60 | 0.40 | 300 | 20 | 10 | 7.5 | 90 |
| CM1210D-900□ | 90 | 0.50 | 280 | 20 | 10 | 7.5 | 90 |
| CM2012B-900□ | 90 | 0.30 | 300 | 20 | 10 | 3.5 | 100 |
| CM2012C-240□ | 24 | 0.20 | 300 | 20 | 10 | 6.0 | 100 |
| CM2012C-300□ | 30 | 0.20 | 300 | 20 | 10 | 6.0 | 100 |
| CM2012C-600□ | 60 | 0.30 | 300 | 20 | 10 | 6.0 | 100 |
| CM2012C-900□ | 90 | 0.30 | 300 | 20 | 10 | 6.0 | 100 |
| CM2012D-120N | 12 | 0.25 | 420 | 20 | 10 | 7.5 | 100 |
| CM2012D-240□ | 24 | 0.25 | 420 | 20 | 10 | 7.5 | 100 |
| CM2012D-250□ | 25 | 0.22 | 420 | 20 | 10 | 7.5 | 100 |
| CM2012D-320□ | 32 | 0.25 | 400 | 20 | 10 | 7.5 | 100 |
| CM2012D-600□ | 60 | 0.30 | 300 | 20 | 10 | 7.5 | 100 |
| CM2012D-900□ | 90 | 0.30 | 300 | 20 | 10 | 7.5 | 100 |

| Part No. | Common Impedance Z(Ω) at 100MHz | DCR (Ω) | Rate Current Max.(mA) | Rate Voltage Typ.(V) | Insulation Resistance IR (MΩ)Min. | Withstanding Voltage Vdc (V)Typical |
|--------------|---------------------------------|---------|-----------------------|----------------------|-----------------------------------|-------------------------------------|
| CM1608A-670□ | 67 | 0.30 | 300 | 50 | 10 | 125 |
| CM1608A-900□ | 90 | 0.30 | 300 | 50 | 10 | 125 |
| CM1608A-121□ | 120 | 0.36 | 250 | 50 | 10 | 125 |
| CM1608A-161□ | 160 | 0.40 | 200 | 50 | 10 | 125 |
| CM1608A-221□ | 220 | 0.42 | 200 | 50 | 10 | 125 |
| CM2012A-670□ | 67 | 0.26 | 400 | 50 | 10 | 125 |
| CM2012A-900□ | 90 | 0.30 | 400 | 50 | 10 | 125 |
| CM2012A-121□ | 120 | 0.30 | 350 | 50 | 10 | 125 |
| CM2012A-161□ | 160 | 0.30 | 350 | 50 | 10 | 125 |
| CM2012A-181□ | 180 | 0.35 | 330 | 50 | 10 | 125 |
| CM2012A-221□ | 220 | 0.35 | 330 | 50 | 10 | 125 |
| CM2012A-261□ | 260 | 0.40 | 300 | 50 | 10 | 125 |
| CM2012A-361□ | 360 | 0.40 | 280 | 50 | 10 | 125 |
| CM3216A-670□ | 67 | 0.25 | 400 | 50 | 10 | 125 |
| CM3216A-900□ | 90 | 0.30 | 400 | 50 | 10 | 125 |
| CM3216A-121□ | 120 | 0.35 | 370 | 50 | 10 | 125 |
| CM3216A-161□ | 160 | 0.40 | 340 | 50 | 10 | 125 |
| CM3216A-261□ | 260 | 0.50 | 310 | 50 | 10 | 125 |
| CM3216A-361□ | 360 | 0.60 | 290 | 50 | 10 | 125 |
| CM3216A-601□ | 600 | 0.80 | 260 | 50 | 10 | 125 |
| CM3216A-102□ | 1000 | 1.00 | 230 | 50 | 10 | 125 |
| CM3216A-222□ | 2200 | 1.20 | 200 | 50 | 10 | 125 |

Ultra-small SMD Wound Ferrite Common Mode Choke---CM/PCM/TCM Series

Operating Temp. : -25°C~85°C ; Storage Temp. and Humidity : -25°C~85°C , 70%RH max.

Feature

- Winding type realizes small size and low profile
- Prevention of common mode noise at high frequency
- Ideal for different noise level and signal frequency
- Excellent solder ability

Application

- CM Series : Used in USB/DVI/HDMI/USB3.0/DP PORT
A Type : USB2.0/IEEE1394 for normal speed
C Type : C TYPE : DVI/HDMI1.4/Display-Port(DP) for Ultra-speed.
D Type : USB3.0 / DP-II for Ultra-speed.
- PCM Series : Used in DC Power Supply input for filter
- TCM Series : Used in LAN Port(RJ45) filter
- CF Series : Used in Vehicle electronic for EMI

Production identification

PCM/TCM ① 2520 ② D ③ 350 ④ S ⑤

| |
|--------------|
| PCM/TCM ① |
| Product Name |

| |
|------------------|
| D ③ |
| Classification |
| D: USB3.0/7.5GHZ |

| |
|---------------------|
| 350 ④ |
| Impedance value |
| 350 : 35Ω at 100MHz |

| | |
|--|--------------------|
| External Dimensions {L×W×H[max.]} [Unit: mm] | |
| 2520 | 2.5 × 2.5 × 1.2 |
| 3225 | 1.20 × 1.00 × 0.90 |
| 4532 | 1.60 × 0.80 × 1.20 |

| |
|-----------|
| S ⑤ |
| Tolerance |
| M : ±20% |
| S : ±25% |

※PCM/TCM Series

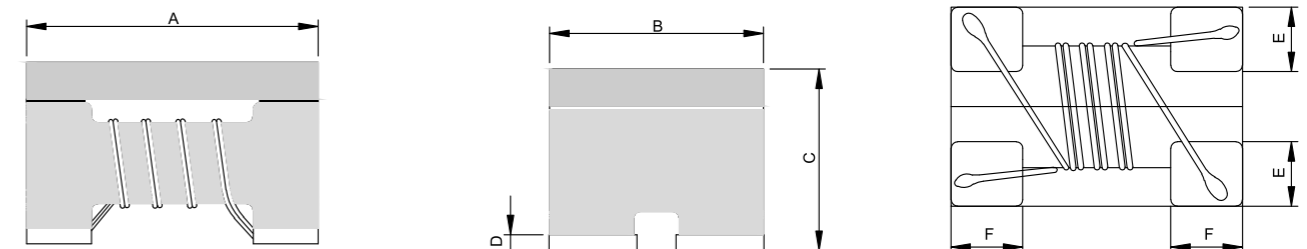

| Series | A | B | C | D | E | F |
|--------|-----------|-----------|-----------|-----------|------------|------------|
| 2520 | 2.5 ± 0.2 | 2.0 ± 0.2 | 1.2 ± 0.2 | 0.2 ± 0.1 | 0.50 ± 0.1 | 0.45 ± 0.1 |
| 3225 | 3.2 ± 0.2 | 2.5 ± 0.2 | 2.2 ± 0.2 | 0.2 ± 0.1 | 0.80 Typ | 0.65 Typ |
| 4532 | 4.5 ± 0.2 | 3.2 ± 0.2 | 2.8 ± 0.2 | 0.2 ± 0.1 | 1.2 Typ. | 1.0 Typ. |

Ultra-small SMD Wound Ferrite Common Mode Choke---CM/PCM/TCM Series

Operating Temp. : -25°C~85°C ; Storage Temp. and Humidity : -25°C~85°C , 70%RH max.

Electrical Characteristics

| Part No. | Common Impedance Z(Ω) at 100MHz | DCR (Ω) | Rate Current Max.(mA) | Rate Voltage Typ.(V) | Insulation Resistance IR (MΩ)Min. |
|----------------|---------------------------------|---------|-----------------------|----------------------|-----------------------------------|
| PCM3225A-800S | 80 | 0.15 | 2.0 | 50 | 10 |
| PCM3225A-601S | 600 | 0.25 | 1.0 | 50 | 10 |
| PCM3225-102S | 1000 | 0.35 | 1.2 | 50 | 10 |
| PCM4532A-102S | 1000 | 0.40 | 1.0 | 50 | 10 |
| PCM4532A-601S | 600 | 0.30 | 1.5 | 50 | 10 |
| PCM4532A-801S | 800 | 0.10 | 1.0 | 50 | 10 |
| TCM2520-601-3P | 600 | 1.20 | 200 | 20 | 10 |
| TCM2520-801-3P | 800 | 1.60 | 150 | 20 | 10 |

Ultra-small SMD Wound Ferrite Common Mode Choke---CM/PCM/TCM Series

Operating Temp. : -25°C~85°C ; Storage Temp. and Humidity : -25°C~85°C , 70%RH max.

Feature

- Winding type realizes small size and low profile
- Prevention of common mode noise at high frequency
- Ideal for different noise level and signal frequency
- Excellent solder ability

Application

- CM Series : Used in USB/DVI/HDMI/USB3.0/DP PORT
A Type : USB2.0/IEEE1394 for normal speed
C Type : C TYPE : DVI/HDMI1.4/Display-Port(DP) for Ultra-speed.
D Type : USB3.0 / DP-II for Ultra-speed.
- PCM Series : Used in DC Power Supply input for filter
- TCM Series : Used in LAN Port(RJ45) filter
- CF Series : Used in Vehicle electronic for EMI

Production identification

BT ① 0806 ② D ③ 350 ④ S ⑤

| |
|--------------|
| BT ① |
| Product Name |

| |
|------------------|
| D ③ |
| Classification |
| D: USB3.0/7.5GHz |

| |
|---------------------|
| 350 ④ |
| Impedance value |
| 350 : 35Ω at 100MHz |

| | |
|--|-----------------|
| External Dimensions {L×W×H[max.]} [Unit: mm] | |
| 2012 | 2.0 × 2.0 × 1.2 |

| |
|-----------|
| S ⑤ |
| Tolerance |
| M : ± 20% |
| S : ± 25% |

※BT Series

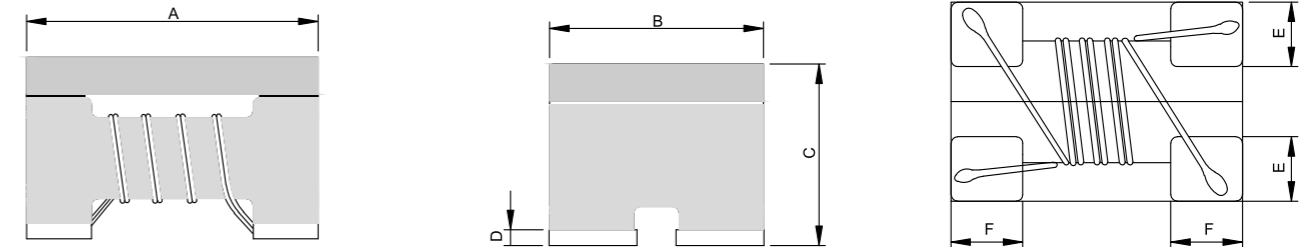

| Series | A | B | C | D | E (Typ.) | F (Typ.) |
|--------|-----------|-----------|-----------|-----------|----------|----------|
| 2012 | 2.0 ± 0.2 | 1.2 ± 0.2 | 1.2 ± 0.2 | 0.2 ± 0.1 | 0.40 | 0.45 |

Ultra-small SMD Wound Ferrite Common Mode Choke---CM/PCM/TCM Series

Operating Temp. : -25°C~85°C ; Storage Temp. and Humidity : -25°C~85°C , 70%RH max.

Electrical Characteristics

| Part No. | Freq. Range (MHZ) | UB/B Impedance (MΩ) | Insertion Loss (dB) Max | CMRR (dB) Min | Rated Voltage (DC) (V) | DCR (Ω) | Withstand Voltage (DC) (V) | Insulation Resistance Min. (MΩ) | Idc (mA) |
|-------------|-------------------|---------------------|-------------------------|---------------|------------------------|---------|----------------------------|---------------------------------|----------|
| BT2012A-750 | 45~870 | 75/75 | 1.0 | 20 | 50 | - | 125 | 10 | - |
| BT2012H-750 | 50~1200 | 75/75 | 1.2 | 20 | 20 | 0.7 | 125 | 10 | 280 |

Insertion Loss Characteristics

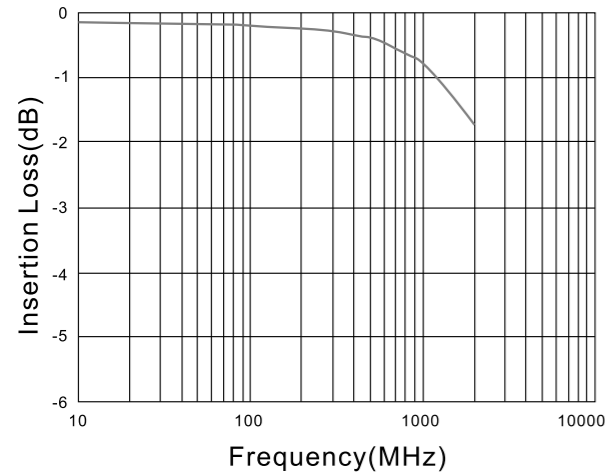

CMRR Characteristics

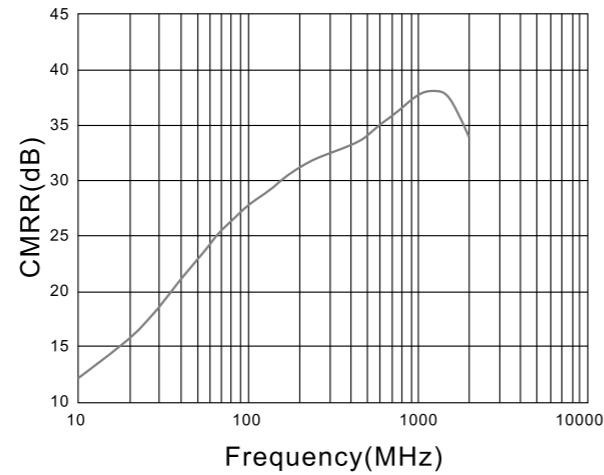

Ultra-small SMD Wound Ferrite Common Mode Choke---CM/PCM/TCM Series

Operating Temp. : -25°C~85°C ; Storage Temp. and Humidity : -25°C~85°C , 70%RH max.

Feature

- Winding type realizes small size and low profile
- Prevention of common mode noise at high frequency
- Ideal for different noise level and signal frequency
- Excellent solder ability

Application

- CM Series : Used in USB/DVI/HDMI/USB3.0/DP PORT
A Type : USB2.0/IEEE1394 for normal speed
C Type : C TYPE : DVI/HDMI1.4/Display-Port(DP) for Ultra-speed.
D Type : USB3.0 / DP-II for Ultra-speed.
- PCM Series : Used in DC Power Supply input for filter
- TCM Series : Used in LAN Port(RJ45) filter
- CF Series : Used in Vehicle electronic for EMI

Production identification

CF 4532 A 101

① ② ③ ④ ⑤

| |
|--------------|
| CF ① |
| Product Name |

| |
|------------------|
| D ③ |
| Classification |
| D: USB3.0/7.5GHz |

| |
|---------------------|
| 350 ④ |
| Impedance value |
| 350 : 35Ω at 100MHz |

| | |
|--|-----------------|
| External Dimensions {L×W×H[max.]} [Unit: mm] | |
| 4532 | 4.5 × 4.5 × 2.8 |

| |
|-----------|
| S ⑤ |
| Tolerance |
| M : ±20% |
| S : ±25% |

※BT Series

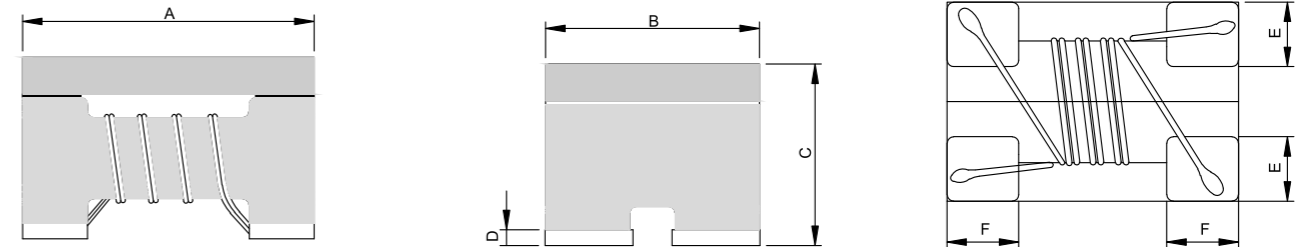

| Series | A | B | C | D | E (Typ.) | F (Typ.) |
|--------|-----------|-----------|-----------|-----------|----------|----------|
| 4532 | 4.5 ± 0.2 | 3.2 ± 0.2 | 2.8 ± 0.2 | 0.2 ± 0.1 | 1.2 | 1.0 |

Ultra-small SMD Wound Ferrite Common Mode Choke---CM/PCM/TCM Series

Operating Temp. : -25°C~85°C ; Storage Temp. and Humidity : -25°C~85°C , 70%RH max.

Electrical Characteristics

| P/N | Z(Ω) | | L(μH) | | DCR (Ω) | Idc(mA) | Rated Voltage | Insulation Resistance |
|--------------|-------------|------------|-------------|---------|---------|---------|---------------|-----------------------|
| | Common Mode | | Common Mode | | | | | |
| | Impedance | Inductance | [Max] | [Max] | | | | |
| CF 4532A-101 | min. | 2000 | (+50%/−30%) | | 3.00 | 150 | 50 | 10 |
| | typ. | 5000 | 100 | | | | | |
| CF 4532A-110 | min. | 300 | (+50%/−30%) | | 0.60 | 250 | 50 | 10 |
| | typ. | 700 | 11 | | | | | |
| CF 4532A-220 | min. | 500 | (+50%/−30%) | | 1.00 | 200 | 50 | 10 |
| | typ. | 1000 | 22 | | | | | |
| CF 4532A-510 | min. | 1000 | (+50%/−30%) | | 1.00 | 200 | 50 | 10 |
| | typ. | 2000 | 51 | | | | | |

Wire Wound Chip Inductors-----WI Series

Operating Temp. : -40°C~125°C(including self-heating)

Feature

- Miniature size, suitable for surface mounting
- High Q value and high self-resonant frequency with ceramic material
- Excellent in solder ability and heat resistance

Application

- High frequency circuit in telecommunication and other equipment
- Mobile phones such as GSM,CDMA, PDC ,etc.
- Bluetooth ,W-LAN, Broadband network.

Production identification

WI C 1005 - 1N0 K

① ② ③ ④ ⑤

① WI
Series Name

② WI
Material Name
C : Ceramic
F : Ferrite

③ External Dimensions (L×W) [Unit: mm]

| | |
|--|--|
| | |
| | |
| | |
| | |

④ 1N0
Inductance value
1N0 : 1.0nH
010 : 10nH
015 : 15nH

※WI Series

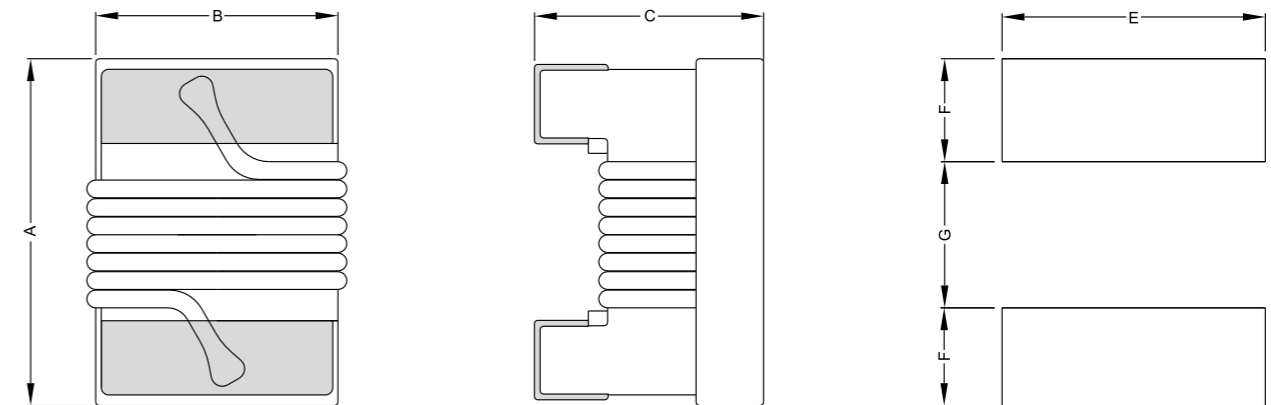

| TYPE(型式) | A | B | C | D | E | F | G |
|---------------|-------------|-------------|-------------|-------------|-------------|-------------|-------------|
| WIC1005(0402) | 1.2 ± 0.10 | 0.60 ± 0.10 | 0.60 ± 0.10 | 0.23 ± 0.05 | 0.23 ± 0.05 | 0.40 ± 0.05 | 0.64 ± 0.05 |
| WIC1608(0603) | 1.68 ± 0.10 | 1.00 ± 0.10 | 0.85 ± 0.10 | 0.30 ± 0.05 | 0.30 ± 0.05 | 0.64 ± 0.05 | 0.64 ± 0.05 |
| W□2012(0805) | 2.20 ± 0.10 | 1.60 ± 0.10 | 1.30 ± 0.10 | 0.50 ± 0.07 | 0.50 ± 0.07 | 1.02 ± 0.05 | 0.76 ± 0.05 |
| W□2520(1008) | 2.65 ± 0.10 | 2.60 ± 0.10 | 2.00 ± 0.10 | 0.50 ± 0.07 | 0.50 ± 0.07 | 1.02 ± 0.05 | 1.27 ± 0.05 |
| W□3225(1210) | 3.35 ± 0.15 | 2.70 ± 0.10 | 2.10 ± 0.10 | 0.50 ± 0.07 | 0.50 ± 0.07 | 1.02 ± 0.05 | 1.78 ± 0.05 |
| WIF4535(1812) | 4.65 ± 0.20 | 3.25 ± 0.10 | 3.00 ± 0.10 | 0.65 ± 0.07 | 0.65 ± 0.07 | 1.14 ± 0.05 | 3.00 ± 0.05 |

Wire Wound Chip Inductors-----WI Series

Operating Temp. : -40°C~125°C(including self-heating)

SPECIFICATION TABLE

| PART NUMBER 品名 | INDUCTANCE (nH) 电感值 | Q (min) 品质系数 | DCR(max) (Ω) 直流电阻 | IDC(max) (mA) 定格电流 | SRF(min) (MHz) 自谐频率 |
|-------------------|---------------------------|--------------------|-------------------------|--------------------------|---------------------------|
| WIC1005-1N0K | 1.0@250MHz | 16 | 0.045 | 1360 | >6000 |
| WIC1005-2N0K | 2.0@250MHz | 16 | 0.070 | 1040 | >6000 |
| WIC1005-2N2K | 2.2@250MHz | 19 | 0.070 | 960 | >6000 |
| WIC1005-3N3K | 3.3@250MHz | 19 | 0.066 | 840 | 6000 |
| WIC1005-3N6K | 3.6@250MHz | 19 | 0.066 | 840 | 6000 |
| WIC1005-3N9K | 3.9@250MHz | 19 | 0.066 | 840 | 5800 |
| WIC1005-5N1K | 5.1@250MHz | 20 | 0.083 | 800 | 5800 |
| WIC1005-5N6K | 5.6@250MHz | 20 | 0.083 | 760 | 5800 |
| WIC1005-6N2K | 6.2@250MHz | 20 | 0.083 | 760 | 5800 |
| WIC1005-7N5K | 7.5@250MHz | 22 | 0.104 | 680 | 5800 |
| WIC1005-8N2K | 8.2@250MHz | 22 | 0.104 | 680 | 4400 |
| WIC1005-9N0K | 9.0@250MHz | 22 | 0.104 | 680 | 4160 |
| WIC1005-011K | 11@250MHz | 24 | 0.120 | 640 | 3680 |
| WIC1005-012K | 12@250MHz | 24 | 0.120 | 640 | 3600 |
| WIC1005-015K | 15@250MHz | 24 | 0.172 | 560 | 3280 |
| WIC1005-019K | 19@250MHz | 24 | 0.202 | 480 | 3040 |
| WIC1005-023K | 23@250MHz | 24 | 0.214 | 400 | 2720 |
| WIC1005-027K | 27@250MHz | 24 | 0.298 | 400 | 2480 |
| WIC1005-036K | 36@250MHz | 24 | 0.403 | 320 | 2320 |
| WIC1005-040K | 40@250MHz | 24 | 0.438 | 320 | 2240 |
| WIC1608-1N6J | 1.6@250MHz | 24 | 0.030 | 700 | 12500 |
| WIC1608-1N8J | 1.8@250MHz | 16 | 0.045 | 700 | 12500 |
| WIC1608-3N6J | 3.6@250MHz | 22 | 0.075 | 700 | 5900 |
| WIC1608-3N9J | 3.9@250MHz | 22 | 0.080 | 700 | 6900 |
| WIC1608-4N3J | 4.3@250MHz | 22 | 0.075 | 700 | 5900 |
| WIC1608-4N7J | 4.7@250MHz | 20 | 0.116 | 700 | 5800 |
| WIC1608-5N1J | 5.1@250MHz | 20 | 0.120 | 700 | 5700 |
| WIC1608-6N8J | 5.6@250MHz | 27 | 0.110 | 700 | 5800 |
| WIC1608-7N5J | 6.2@250MHz | 28 | 0.110 | 700 | 4800 |
| WIC1608-8N7J | 7.5@250MHz | 28 | 0.120 | 700 | 4600 |
| WIC1608-9N5J | 8.2@250MHz | 28 | 0.135 | 700 | 5400 |
| WIC1608-010J | 9.0@250MHz | 31 | 0.130 | 700 | 4800 |
| WIC1608-011J | 11@250MHz | 33 | 0.130 | 700 | 4000 |
| WIC1608-012J | 12@250MHz | 35 | 0.130 | 700 | 4000 |
| WIC1608-015J | 15@250MHz | 35 | 0.150 | 700 | 4000 |
| WIC1608-016J | 16@250MHz | 34 | 0.160 | 700 | 3300 |
| WIC1608-018J | 18@250MHz | 35 | 0.170 | 700 | 3100 |
| WIC1608-022J | 22@250MHz | 38 | 0.190 | 700 | 3000 |
| WIC1608-024J | 24@250MHz | 37 | 0.200 | 700 | 2650 |
| WIC1608-027J | 27@250MHz | 40 | 0.220 | 600 | 2800 |
| WIC1608-030J | 30@250MHz | 37 | 0.220 | 600 | 2250 |
| WIC1608-033J | 33@250MHz | 40 | 0.220 | 600 | 2300 |
| WIC1608-036J | 36@250MHz | 38 | 0.250 | 600 | 2080 |
| WIC1608-039J | 39@250MHz | 40 | 0.250 | 600 | 2200 |
| WIC1608-043J | 43@250MHz | 39 | 0.280 | 600 | 2000 |
| WIC1608-047J | 47@250MHz | 38 | 0.280 | 600 | 2000 |
| WIC1608-056J | 56@250MHz | 38 | 0.280 | 600 | 1900 |
| WIC1608-068J | 68@250MHz | 37 | 0.340 | 600 | 1700 |

Wire Wound Chip Inductors-----WI Series

Operating Temp. : -40°C~125°C(including self-heating)

| PART NUMBER 品名 | INDUCTANCE (nH) 电感值 | Q (min) 品质系数 | DCR(max) (Ω) 直流电阻 | IDC(max) (mA) 定格电流 | SRF(min) (MHz) 自谐频率 |
|-------------------|---------------------------|--------------------|-------------------------|--------------------------|---------------------------|
| WIC1608-072J | 72@250MHz | 34 | 0.380 | 400 | 1700 |
| WIC1608-082J | 82@250MHz | 34 | 0.480 | 400 | 1700 |
| WIC1608-R10J | 100@250MHz | 34 | 0.580 | 400 | 1400 |
| WIC1608-R11J | 110@250MHz | 32 | 0.610 | 300 | 1350 |
| WIC1608-R12J | 120@250MHz | 32 | 0.650 | 300 | 1300 |
| WIC1608-R15J | 150@250MHz | 28 | 0.750 | 280 | 990 |
| WIC1608-R18J | 180@250MHz | 25 | 1.050 | 240 | 990 |
| WIC1608-R22J | 220@250MHz | 25 | 1.200 | 200 | 900 |
| WIC1608-R24J | 270@250MHz | 24 | 1.400 | 170 | 900 |
| WIC1608-R33J | 330@250MHz | 24 | 1.600 | 160 | 850 |
| WIC1608-R39J | 390@250MHz | 24 | 2.200 | 150 | 800 |
| WIC2012-2N2K | 2.2@250MHz | 50@1500MHz | 0.030 | 800 | 8500 |
| WIC2012-2N7K | 2.7@250MHz | 50@1500MHz | 0.045 | 800 | 8000 |
| WIC2012-3N3K | 3.3@250MHz | 50@1500MHz | 0.090 | 600 | 7900 |
| WIC2012-5N6K | 5.6@250MHz | 65@1000MHz | 0.065 | 600 | 5500 |
| WIC2012-6N8K | 6.8@250MHz | 50@1000MHz | 0.110 | 600 | 5500 |
| WIC2012-8N2K | 8.2@250MHz | 50@1000MHz | 0.120 | 600 | 4700 |
| WIC2012-010K | 10@250MHz | 60@500MHz | 0.150 | 600 | 4200 |
| WIC2012-012K | 12@250MHz | 50@500MHz | 0.150 | 600 | 4000 |
| WIC2012-015K | 15@250MHz | 50@500MHz | 0.170 | 600 | 3400 |
| WIC2012-018K | 18@250MHz | 50@500MHz | 0.200 | 600 | 3300 |
| WIC2012-022K | 22@250MHz | 55@500MHz | 0.220 | 500 | 2600 |
| WIC2012-027K | 27@250MHz | 55@500MHz | 0.250 | 500 | 2500 |
| WIC2012-033K | 33@250MHz | 60@500MHz | 0.270 | 500 | 2050 |
| WIC2012-039K | 39@250MHz | 60@500MHz | 0.290 | 500 | 2000 |
| WIC2012-047K | 47@250MHz | 60@500MHz | 0.310 | 500 | 1650 |
| WIC2012-056K | 56@250MHz | 60@500MHz | 0.340 | 500 | 1550 |
| WIC2012-062K | 62@250MHz | 60@500MHz | 0.380 | 500 | 1500 |
| WIC2012-068K | 68@250MHz | 60@500MHz | 0.380 | 500 | 1450 |
| WIC2012-082K | 82@250MHz | 65@500MHz | 0.420 | 400 | 1300 |
| WIC2012-R10K | 100@250MHz | 65@500MHz | 0.460 | 400 | 1200 |
| WIC2012-R12K | 120@250MHz | 50@250MHz | 0.510 | 400 | 1100 |
| WIC2012-R15K | 150@250MHz | 50@250MHz | 0.560 | 400 | 920 |
| WIC2012-R18K | 180@250MHz | 50@250MHz | 0.640 | 400 | 870 |
| WIC2012-R20K | 200@250MHz | 50@250MHz | 1.000 | 400 | 850 |
| WIC2012-R22K | 220@250MHz | 50@250MHz | 1.050 | 400 | 850 |
| WIC2012-R27K | 270@250MHz | 48@250MHz | 1.100 | 350 | 650 |
| WIC2012-R33K | 330@250MHz | 48@250MHz | 1.400 | 310 | 600 |
| WIC2012-R39K | 390@250MHz | 48@250MHz | 1.500 | 290 | 560 |
| WIC2012-R47K | 470@250MHz | 33@100MHz | 1.760 | 250 | 375 |
| WIC2012-R56K | 560@250MHz | 23@50MHz | 1.900 | 230 | 340 |
| WIC2012-R62K | 620@250MHz | 23@50MHz | 2.080 | 200 | 320 |
| WIC2012-R68K | 680@250MHz | 23@50MHz | 2.100 | 190 | 300 |
| WIC2012-R75K | 750@250MHz | 23@50MHz | 2.120 | 180 | 280 |
| WIC2012-R82K | 820@250MHz | 23@50MHz | 2.140 | 180 | 250 |
| WIC2012-R91K | 910@250MHz | 23@50MHz | 2.280 | 180 | 220 |
| WIC2012-1R0K | 1000@250MHz | 23@50MHz | 2.400 | 170 | 200 |
| WIC2012-1R2K | 1200@250MHz | 22@50MHz | 2.55 | 170 | 180 |
| WIC2012-1R5K | 1500@250MHz | 21@50MHz | 2.800 | 160 | 170 |
| WIC2012-1R8K | 1800@250MHz | 21@50MHz | 3.200 | 150 | 160 |
| WIC2012-2R2K | 2200@250MHz | 21@50MHz | 2.800 | 150 | 150 |

Wire Wound Chip Inductors-----WI Series

Operating Temp. : -40°C~125°C(including self-heating)

| PART NUMBER 品名 | INDUCTANCE (nH) 电感值 | Q (min) 品质系数 | DCR(max) (Ω) 直流电阻 | IDC(max) (mA) 定格电流 | SRF(min) (MHz) 自谐频率 |
|-------------------|---------------------------|--------------------|-------------------------|--------------------------|---------------------------|
| WIC2520-3N9J | 3.9@50MHz | 50@1500MHz | 0.035 | 1000 | 6000 |
| WIC2520-4N7J | 4.7@50MHz | 50@1500MHz | 0.045 | 1000 | 6000 |
| WIC2520-5N6J | 5.6@50MHz | 50@1000MHz | 0.080 | 1000 | 6000 |
| WIC2520-8N2J | 8.2@50MHz | 50@1000MHz | 0.050 | 1000 | 5000 |
| WIC2520-010J | 10@50MHz | 50@500MHz | 0.080 | 1000 | 4100 |
| WIC2520-012J | 12@50MHz | 50@500MHz | 0.090 | 1000 | 3300 |
| WIC2520-015J | 15@50MHz | 50@500MHz | 0.100 | 1000 | 2500 |
| WIC2520-018J | 18@50MHz | 50@350MHz | 0.110 | 1000 | 2500 |
| WIC2520-022J | 22@50MHz | 55@350MHz | 0.120 | 1000 | 2400 |
| WIC2520-027J | 27@50MHz | 55@350MHz | 0.130 | 1000 | 1600 |
| WIC2520-033J | 33@50MHz | 60@350MHz | 0.140 | 1000 | 1600 |
| WIC2520-039J | 39@50MHz | 60@350MHz | 0.150 | 1000 | 1500 |
| WIC2520-047J | 47@50MHz | 65@350MHz | 0.160 | 1000 | 1500 |
| WIC2520-056J | 56@50MHz | 65@350MHz | 0.180 | 1000 | 1300 |
| WIC2520-062J | 62@50MHz | 65@350MHz | 0.200 | 1000 | 1300 |
| WIC2520-068J | 68@50MHz | 65@350MHz | 0.200 | 1000 | 1300 |
| WIC2520-075J | 75@50MHz | 60@350MHz | 0.200 | 1000 | 1200 |
| WIC2520-082J | 82@50MHz | 60@350MHz | 0.220 | 1000 | 1000 |
| WIC2520-R10J | 100@25MHz | 60@350MHz | 0.560 | 650 | 1000 |
| WIC2520-R12J | 120@25MHz | 60@350 MHz | 0.630 | 650 | 950 |
| WIC2520-R15J | 150@25MHz | 45@100 MHz | 0.700 | 580 | 850 |
| WIC2520-R18J | 180@25MHz | 45@100 MHz | 0.770 | 620 | 750 |
| WIC2520-R20J | 180@25MHz | 45@100 MHz | 0.800 | 550 | 750 |
| WIC2520-R22J | 220@25MHz | 45@100 MHz | 0.840 | 500 | 700 |
| WIC2520-R24J | 240@25MHz | 45@100 MHz | 0.880 | 500 | 600 |
| WIC2520-R27J | 270@25MHz | 45@100 MHz | 0.910 | 500 | 600 |
| WIC2520-R33J | 330@25MHz | 45@100 MHz | 1.050 | 450 | 570 |
| WIC2520-R39J | 390@25MHz | 45@100 MHz | 1.120 | 470 | 500 |
| WIC2520-R47J | 470@25MHz | 45@100 MHz | 1.190 | 470 | 450 |
| WIC2520-R56J | 560@25MHz | 45@100 MHz | 1.330 | 400 | 415 |
| WIC2520-R62J | 620@25MHz | 45@100 MHz | 1.400 | 400 | 375 |
| WIC2520-R68J | 680@25MHz | 45@100 MHz | 1.470 | 400 | 375 |
| WIC2520-R75J | 750@25MHz | 45@100 MHz | 1.540 | 360 | 360 |
| WIC2520-R82J | 820@25MHz | 45@100 MHz | 1.610 | 400 | 350 |
| WIC2520-R91J | 910@25MHz | 35@50 MHz | 1.680 | 380 | 320 |
| WIC2520-1R0J | 1000@25MHz | 35@50 MHz | 1.750 | 370 | 290 |
| WIC2520-1R2J | 1200@25MHz | 35@50 MHz | 2.000 | 310 | 250 |
| WIC2520-1R5J | 1500@7.9MHz | 28@50 MHz | 2.300 | 330 | 200 |
| WIC2520-1R8J | 1800@7.9MHz | 28@50 MHz | 2.600 | 300 | 160 |
| WIC2520-2R2J | 2200@7.9MHz | 28@50 MHz | 2.800 | 280 | 160 |
| WIC2520-2R7J | 2700@7.9MHz | 22@25 MHz | 3.200 | 290 | 140 |
| WIC2520-3R3J | 3300@7.9MHz | 22@25 MHz | 3.400 | 290 | 110 |
| WIC2520-3R9J | 3900@7.9MHz | 20@25 MHz | 3.600 | 260 | 100 |
| WIC2520-4R7J | 4700@7.9MHz | 20@25 MHz | 4.000 | 260 | 90 |
| WIC2520-5R6J | 5600@7.9MHz | 20@7.9 MHz | 7.600 | 240 | 60 |
| WIC2520-6R8J | 6800@7.9MHz | 20@7.9 MHz | 8.200 | 200 | 60 |

Wire Wound Chip Inductors-----WI Series

Operating Temp. : -40°C~125°C(including self-heating)

| PART NUMBER 品名 | INDUCTANCE (nH) 电感值 | Q (min) 品质系数 | DCR(max) (Ω) 直流电阻 | IDC(max) (mA) 定格电流 | SRF(min) (MHz) 自谐频率 |
|-------------------|---------------------------|--------------------|-------------------------|--------------------------|---------------------------|
| WIC3225-3N9J | 3.9@100MHz | 30@300MHz | 0.050 | 1000 | 6000 |
| WIC3225-4N7J | 4.7@100MHz | 30@300MHz | 0.065 | 1000 | 5800 |
| WIC3225-8N2J | 8.2@100MHz | 30@300MHz | 0.070 | 1000 | 5500 |
| WIC3225-010J | 10@100MHz | 40@300MHz | 0.080 | 1000 | 4000 |
| WIC3225-012J | 12@100MHz | 40@300MHz | 0.080 | 1000 | 3200 |
| WIC3225-015J | 15@100MHz | 40@300MHz | 0.100 | 1000 | 3200 |
| WIC3225-018J | 18@100MHz | 50@300 | 0.100 | 1000 | 2800 |
| WIC3225-022J | 22@100MHz | 50@300 | 0.100 | 1000 | 2200 |
| WIC3225-027J | 27@100MHz | 50@300 | 0.110 | 1000 | 1800 |
| WIC3225-033J | 33@100MHz | 55@300 | 0.110 | 1000 | 1800 |
| WIC3225-039J | 39@100MHz | 55@300 | 0.120 | 1000 | 1800 |
| WIC3225-043J | 43@100MHz | 55@300 | 0.120 | 1000 | 1500 |
| WIC3225-047J | 47@100MHz | 55@300 | 0.130 | 1000 | 1500 |
| WIC3225-056J | 56@100MHz | 55@300 | 0.140 | 1000 | 1450 |
| WIC3225-068J | 68@100MHz | 55@300 | 0.150 | 900 | 1200 |
| WIC3225-082J | 82@100MHz | 55@300 | 0.200 | 900 | 1200 |
| WIC3225-R10J | 100@100MHz | 55@300 | 0.210 | 850 | 1100 |
| WIC3225-R12J | 120@100MHz | 60@300 | 0.210 | 800 | 1100 |
| WIC3225-R15J | 150@100MHz | 60@300 | 0.250 | 750 | 950 |
| WIC3225-R18J | 180@50MHz | 60@300 | 0.300 | 700 | 900 |
| WIC3225-R22J | 220@50MHz | 60@300 | 0.320 | 670 | 760 |
| WIC3225-R27J | 270@50MHz | 55@300 | 0.340 | 630 | 730 |
| WIC3225-R33J | 330@50MHz | 45@150 | 0.380 | 590 | 650 |
| WIC3225-R39J | 390@50MHz | 45@150 | 0.580 | 530 | 600 |
| WIC3225-R47J | 470@50MHz | 45@150 | 0.800 | 490 | 550 |
| WIC3225-R56J | 560@35MHz | 45@150 | 1.100 | 460 | 470 |
| WIC3225-R68J | 680@35MHz | 45@150 | 1.200 | 430 | 450 |
| WIC3225-R82J | 820@35MHz | 45@150 | 1.820 | 400 | 420 |
| WIC3225-1R0J | 1000@35MHz | 45@150 | 1.850 | 320 | 400 |
| WIC3225-1R2J | 1200@35MHz | 45@150 | 1.870 | 300 | 380 |
| WIC3225-1R5J | 1500@7.9MHz | 30@50 | 1.950 | 310 | 160 |
| WIC3225-1R8J | 1800@7.9MHz | 30@50 | 2.250 | 310 | 160 |
| WIC3225-2R2J | 2200@7.9MHz | 30@50 | 2.410 | 310 | 160 |
| WIC3225-2R7J | 2700@7.9MHz | 28@25 | 2.850 | 300 | 140 |
| WIC3225-3R3J | 3300@7.9MHz | 25@25 | 3.120 | 300 | 110 |
| WIC3225-3R9J | 3900@7.9MHz | 25@25 | 3.600 | 290 | 100 |
| WIC3225-4R7J | 4700@7.9MHz | 25@25 | 4.000 | 280 | 75 |
| WIC3225-5R6J | 5600@7.9MHz | 20@7.9 | 5.000 | 250 | 70 |
| WIC3225-6R8J | 6800@7.9MHz | 20@7.9 | 8.000 | 230 | 70 |
| WIC3225-8R6J | 8600@7.9MHz | 20@7.9 | 9.000 | 160 | 55 |

Wire Wound Chip Inductors-----WI Series

Operating Temp. : -40°C~125°C(including self-heating)

| PART NUMBER 品名 | INDUCTANCE (nH) 电感值 | Q (min) 品质系数 | TESTING FREQ.(MHz) 测试频率 | DCR(max) (Ω) 直流电阻 | IDC(max) (mA) 定格电流 | SRF(min) (MHz) 自谐频率 |
|-------------------|---------------------------|--------------------|----------------------------|-------------------------|--------------------------|---------------------------|
| WIF2012-1R2K | 1.2 | 23 | 7.96 | 1.05 | 600 | 350 |
| WIF2012-1R5K | 1.5 | 23 | 7.96 | 1.20 | 580 | 300 |
| WIF2012-1R8K | 1.8 | 23 | 7.96 | 1.35 | 550 | 260 |
| WIF2012-2R2K | 2.2 | 20 | 7.96 | 1.50 | 510 | 210 |
| WIF2012-2R7K | 2.7 | 20 | 7.96 | 1.70 | 460 | 160 |
| WIF2012-3R3K | 3.3 | 20 | 7.96 | 1.80 | 430 | 130 |
| WIF2012-3R9K | 3.9 | 20 | 7.96 | 1.95 | 400 | 115 |
| WIF2012-4R7K | 4.7 | 20 | 7.96 | 2.05 | 370 | 105 |
| WIF2012-5R6K | 5.6 | 20 | 7.96 | 2.30 | 360 | 90 |
| WIF2012-6R8K | 6.8 | 20 | 7.96 | 2.60 | 330 | 85 |
| WIF2520-1R2K | 1.2 | 20 | 7.96 | 0.75 | 550 | 250 |
| WIF2520-1R5K | 1.5 | 20 | 7.96 | 0.80 | 400 | 230 |
| WIF2520-1R8K | 1.8 | 20 | 7.96 | 0.95 | 320 | 168 |
| WIF2520-2R2K | 2.2 | 20 | 7.96 | 1.30 | 315 | 150 |
| WIF2520-2R7K | 2.7 | 20 | 7.96 | 1.40 | 300 | 125 |
| WIF2520-3R3K | 3.3 | 20 | 7.96 | 1.50 | 280 | 110 |
| WIF2520-3R9K | 3.9 | 20 | 7.96 | 1.55 | 250 | 90 |
| WIF2520-4R7K | 4.7 | 20 | 7.96 | 1.75 | 210 | 76 |
| WIF2520-5R6K | 5.6 | 18 | 7.96 | 1.90 | 190 | 76 |
| WIF2520-6R8K | 6.8 | 18 | 7.96 | 2.00 | 175 | 51 |
| WIF2520-8R2K | 8.2 | 18 | 7.96 | 2.20 | 160 | 34 |
| WIF2520-100K | 10 | 18 | 2.52 | 2.50 | 155 | 34 |
| WIF2520-150K | 15 | 18 | 2.52 | 3.00 | 130 | 23 |
| WIF2520-220K | 22 | 18 | 2.52 | 3.90 | 105 | 23 |
| WIF2520-330K | 33 | 15 | 2.52 | 4.80 | 85 | 10 |
| WIF2520-470K | 47 | 15 | 2.52 | 5.70 | 60 | 8.5 |
| WIF2520-680K | 68 | 15 | 2.52 | 6.70 | 50 | 7.1 |
| WIF2520-101K | 100 | 10 | 2.52 | 11.0 | 40 | 4.8 |
| WIF3225-1R2K | 1.2 | 28 | 7.96 | 0.3 | 210 | 450 |
| WIF3225-1R5K | 1.5 | 28 | 7.96 | 0.4 | 200 | 450 |
| WIF3225-1R8K | 1.8 | 28 | 7.96 | 0.5 | 195 | 450 |
| WIF3225-2R2K | 2.2 | 28 | 7.96 | 0.6 | 175 | 450 |
| WIF3225-2R7K | 2.7 | 28 | 7.96 | 0.7 | 160 | 420 |
| WIF3225-3R3K | 3.3 | 28 | 7.96 | 1.1 | 120 | 380 |
| WIF3225-3R9K | 3.9 | 28 | 7.96 | 1.2 | 110 | 360 |
| WIF3225-4R7K | 4.7 | 28 | 7.96 | 1.3 | 105 | 350 |
| WIF3225-5R6K | 5.6 | 28 | 7.96 | 2.0 | 100 | 320 |
| WIF3225-6R8K | 6.8 | 28 | 7.96 | 1.5 | 80 | 310 |
| WIF3225-8R2K | 8.2 | 28 | 7.96 | 1.6 | 75 | 305 |
| WIF3225-100K | 10 | 25 | 2.52 | 1.0 | 70 | 300 |
| WIF3225-120K | 12 | 25 | 2.52 | 1.2 | 65 | 265 |
| WIF3225-150K | 15 | 25 | 2.52 | 2.0 | 60 | 225 |
| WIF3225-180K | 18 | 25 | 2.52 | 2.1 | 45 | 210 |
| WIF3225-220K | 22 | 25 | 2.52 | 2.2 | 35 | 200 |
| WIF3225-270K | 27 | 25 | 2.52 | 2.6 | 30 | 180 |
| WIF3225-330K | 33 | 25 | 2.52 | 2.9 | 23 | 160 |
| WIF3225-390K | 39 | 25 | 2.52 | 3.7 | 21 | 150 |
| WIF3225-470K | 47 | 25 | 2.52 | 4.8 | 20 | 140 |
| WIF3225-560K | 56 | 25 | 2.52 | 5.1 | 15 | 125 |
| WIF3225-680K | 68 | 25 | 2.52 | 4.7 | 15 | 110 |

Wire Wound Chip Inductors-----WI Series

Operating Temp. : -40°C~125°C(including self-heating)

| PART NUMBER 品名 | INDUCTANCE (nH) 电感值 | Q (min) 品质系数 | TESTING FREQ.(MHz) 测试频率 | DCR(max) (Ω) 直流电阻 | IDC(max) (mA) 定格电流 | SRF(min) (MHz) 自谐频率 |
|-------------------|---------------------------|--------------------|----------------------------|-------------------------|--------------------------|---------------------------|
| WIF3225-820K | 82 | 25 | 2.52 | 5.6 | 13 | 100 |
| WIF3225-101K | 100 | 15 | 0.796 | 6.5 | 6.0 | 95 |
| WIF3225-121K | 120 | 15 | 0.796 | 7.1 | 5.0 | 85 |
| WIF3225-151K | 150 | 15 | 0.796 | 8.2 | 4.5 | 80 |
| WIF3225-181K | 180 | 15 | 0.796 | 12.5 | 3.0 | 70 |
| WIF3225-221K | 220 | 15 | 0.796 | 15.3 | 3.0 | 65 |
| WIF3225-271K | 270 | 15 | 0.796 | 16.4 | 2.5 | 60 |
| WIF3225-331K | 330 | 15 | 0.796 | 17.8 | 2.3 | 55 |
| WIF3225-391K | 390 | 10 | 0.796 | 19.5 | 2.2 | 45 |
| WIF3225-471K | 470 | 10 | 0.796 | 21.0 | 2.0 | 40 |
| WIF4532-1R0K | 1.0 | 30 | 7.96 | 0.20 | 1000 | 200 |
| WIF4532-1R2K | 1.2 | 30 | 7.96 | 0.21 | 1000 | 200 |
| WIF4532-1R5K | 1.5 | 30 | 7.96 | 0.22 | 1000 | 180 |
| WIF4532-1R8K | 1.8 | 35 | 7.96 | 0.24 | 950 | 160 |
| WIF4532-2R2K | 2.2 | 35 | 7.96 | 0.25 | 900 | 150 |
| WIF4532-2R7K | 2.7 | 35 | 7.96 | 0.30 | 850 | 145 |
| WIF4532-3R3K | 3.3 | 35 | 7.96 | 0.32 | 800 | 140 |
| WIF4532-3R9K | 3.9 | 35 | 7.96 | 0.40 | 750 | 135 |
| WIF4532-4R7K | 4.7 | 35 | 7.96 | 0.50 | 700 | 120 |
| WIF4532-5R6K | 5.6 | 35 | 7.96 | 0.55 | 650 | 110 |
| WIF4532-6R8K | 6.8 | 35 | 7.96 | 0.80 | 600 | 98 |
| WIF4532-8R2K | 8.2 | 35 | 7.96 | 0.85 | 600 | 95 |
| WIF4532-100K | 10 | 30 | 2.52 | 1.0 | 550 | 75 |
| WIF4532-120K | 12 | 30 | 2.52 | 1.1 | 550 | 70 |
| WIF4532-150K | 15 | 30 | 2.52 | 1.2 | 500 | 60 |
| WIF4532-180K | 18 | 30 | 2.52 | 1.2 | 500 | 29 |
| WIF4532-220K | 22 | 30 | 2.52 | 1.3 | 450 | 25 |
| WIF4532-270K | 27 | 28 | 2.52 | 1.5 | 400 | 22 |
| WIF4532-330K | 33 | 28 | 2.52 | 1.7 | 350 | 18 |
| WIF4532-390K | 39 | 28 | 2.52 | 1.8 | 350 | 14 |
| WIF4532-470K | 47 | 28 | 2.52 | 2.0 | 300 | 14 |
| WIF4532-560K | 56 | 25 | 2.52 | 2.2 | 290 | 14 |
| WIF4532-680K | 68 | 20 | 2.52 | 2.4 | 260 | 5.4 |
| WIF4532-820K | 82 | 20 | 2.52 | 2.8 | 240 | 5.4 |
| WIF4532-101K | 100 | 20 | 0.796 | 3.0 | 220 | 4.2 |
| WIF4532-121K | 120 | 20 | 0.796 | 3.3 | 220 | 3.3 |
| WIF4532-151K | 150 | 20 | 0.796 | 3.7 | 200 | 3.0 |
| WIF4532-181K | 180 | 20 | 0.796 | 4.0 | 200 | 3.0 |
| WIF4532-221K | 220 | 15 | 0.796 | 7.0 | 170 | 2.5 |
| WIF4532-271K | 270 | 15 | 0.796 | 7.6 | 160 | 2.5 |
| WIF4532-331K | 330 | 15 | 0.796 | 8.5 | 150 | 2.0 |
| WIF4532-391K | 390 | 15 | 0.796 | 9.2 | 130 | 2.0 |
| WIF4532-471K | 470 | 10 | 0.796 | 10.4 | 120 | 2.0 |
| WIF4532-561K | 560 | 10 | 0.796 | 12.0 | 110 | 2.0 |
| WIF4532-681K | 680 | 10 | 0.796 | 14.0 | 100 | 1.8 |
| WIF4532-821K | 820 | 10 | 0.796 | 15.0 | 95 | 1.6 |
| WIF4532-102K | 1000 | 10 | 0.252 | 16.5 | 90 | 1.6 |

X-ON Electronics

Largest Supplier of Electrical and Electronic Components

Click to view similar products for [Fixed Inductors](#) category:

Click to view products by [Ceaiya](#) manufacturer:

Other Similar products are found below :

[MLZ1608M6R8WTD25](#) [MLZ1608N6R8LT000](#) [MLZ1608N3R3LTD25](#) [MLZ1608N3R3LT000](#) [MLZ1608N150LT000](#)

[MLZ1608M150WTD25](#) [MLZ1608M3R3WTD25](#) [MLZ1608M3R3WT000](#) [MLZ1608M150WT000](#) [MLZ1608A1R5WT000](#)

[MLZ1608N1R5LT000](#) [B82432C1333K000](#) [PCMB053T-1R0MS](#) [PCMB053T-1R5MS](#) [PCMB104T-1R5MS](#) [CR32NP-100KC](#) [CR32NP-](#)

[151KC](#) [CR32NP-180KC](#) [CR32NP-181KC](#) [CR32NP-1R5MC](#) [CR32NP-390KC](#) [CR32NP-3R9MC](#) [CR32NP-680KC](#) [CR32NP-820KC](#)

[CR32NP-8R2MC](#) [CR43NP-390KC](#) [CR43NP-560KC](#) [CR43NP-680KC](#) [CR54NP-181KC](#) [CR54NP-470LC](#) [CR54NP-820KC](#) [CR54NP-8R5MC](#)

[MGDQ4-00004-P](#) [MGDU1-00016-P](#) [MHL1ECTTP18NJ](#) [MHL1JCTTD12NJ](#) [PE-51506NL](#) [PE-53601NL](#) [PE-53630NL](#) [PE-53824SNLT](#) [PE-](#)

[62892NL](#) [PE-92100NL](#) [PG0434.801NLT](#) [PG0936.113NLT](#) [PM06-2N7](#) [PM06-39NJ](#) [HC2LP-R47-R](#) [HC2-R47-R](#) [HC3-2R2-R](#) [HC8-1R2-R](#)