

Specification Sheet for Approved

| | |
|--------------------|----------------|
| Customer Name: | |
| Customer Part No.: | |
| Ceaiya Part No: | CR4018A Series |
| Spec No: | L418A |

【For Customer Approval Only】

If you Approval, Please Stamp

【RoHS Compliant Parts】

| Approved By | Checked By | Prepared By |
|-------------|------------|-------------|
| 李庆辉 | 刘志坚 | 劳水花 |

Shenzhen Ceaiya Electronics Co., Ltd.

地址 1: 深圳市龙华区观湖街道鹭湖社区观盛二路 5 号捷顺科技中心 B706

地址 2: 广东省东莞清溪镇青滨东路 105 号力合紫荆智能制造中心 10 栋

Http://www.szceaiya.com

Tel: 0769-89135516

Fax: 0769-89135519

1. Shape and Dimension (Unit:mm)

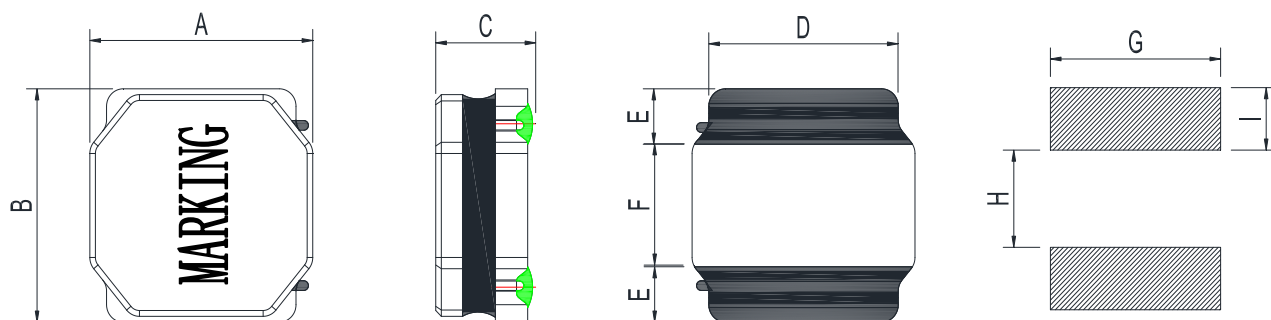

注：喷码尺寸长 2.5 ± 0.5 mm, 宽 2.0 ± 0.5 mm

| A | B | C | D | E | F | G | H | I |
|---------------|---------------|---------|---------------|---------------|---------|---------|---------|---------|
| 4.0 ± 0.2 | 4.0 ± 0.2 | 1.85Max | 3.3 ± 0.2 | 1.0 ± 0.2 | 2.0 Ref | 3.7 Ref | 1.9 Ref | 1.1 Ref |

2. Electronic Characteristics List

| Part Number | Inductance (uH) | Tolerance (±%) | DCR(mΩ) ±30% | Isat (A) | Irise (A) | Test Condition | Marking |
|--------------|-----------------|----------------|--------------|----------|-----------|----------------|---------|
| CR4018A-R47N | 0.47 | 30 | 18 | 6.50 | 4.10 | 100KHz /1.0V | R47 |
| CR4018A-1R0N | 1.0 | 30 | 27 | 4.00 | 3.20 | 100KHz /1.0V | 1R0 |
| CR4018A-1R5N | 1.5 | 30 | 37 | 3.30 | 2.40 | 100KHz /1.0V | 1R5 |
| CR4018A-2R2M | 2.2 | 20 | 42 | 3.00 | 2.20 | 100KHz /1.0V | 2R2 |
| CR4018A-3R3M | 3.3 | 20 | 55 | 2.30 | 2.00 | 100KHz /1.0V | 3R3 |
| CR4018A-4R7M | 4.7 | 20 | 70 | 2.00 | 1.70 | 100KHz /1.0V | 4R7 |
| CR4018A-6R8M | 6.8 | 20 | 98 | 1.60 | 1.45 | 100KHz /1.0V | 6R8 |
| CR4018A-100M | 10 | 20 | 150 | 1.30 | 1.20 | 100KHz /1.0V | 100 |
| CR4018A-150M | 15 | 20 | 210 | 1.10 | 0.85 | 100KHz /1.0V | 150 |
| CR4018A-220M | 22 | 20 | 290 | 0.90 | 0.72 | 100KHz /1.0V | 220 |
| CR4018A-330M | 33 | 20 | 480 | 0.70 | 0.55 | 100KHz /1.0V | 330 |
| CR4018A-390M | 39 | 20 | 780 | 0.68 | 0.55 | 100KHz /1.0V | 390 |
| CR4018A-470M | 47 | 20 | 755 | 0.65 | 0.60 | 100KHz /1.0V | 470 |
| CR4018A-680M | 68 | 20 | 1000 | 0.50 | 0.50 | 100KHz /1.0V | 680 |
| CR4018A-101M | 100 | 20 | 1450 | 0.42 | 0.28 | 100KHz /1.0V | 101 |

※ All test data is referenced to 25°C ambient;

Isat (A) :

DC Saturation Current that will cause initial inductance to drop approximately 30% max.

Irise((A)

DC Current that will cause an approximate ΔT of 40 °C

Measuring Instrument :

L:HIOKI3532-50

DCR:HIOKI 3540

Isat / Irise:HP4284A+42841

3. Construction and materials

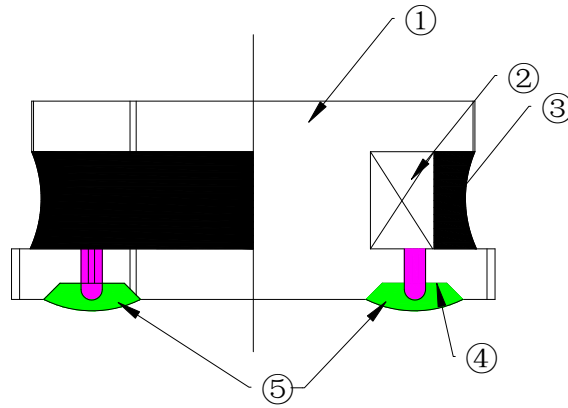

| No. | Part name | Material | Ceaiya P/N |
|-----|--------------------|---|------------|
| ① | Drum Core | Ni-Zn Ferrite Core | YN/YX/DYG |
| ② | Wire | Polyurethane enameled copper wire | YLSL |
| ③ | Adhesive | Epoxy Resin Magnetic Powder | |
| ④ | Plating Electrodes | Plating: Ag 10-20 μm Ni 1-3 μm Sn 3-7 μm | |
| ⑤ | Outer Electrodes | Top surface solder coating Sn99%、 Ag0.3%、Cu0.7% | YX |

4. General Characteristics

4-1. Storage Temperature range : $-40^{\circ}\text{C} \sim +105^{\circ}\text{C}$

4-2. Operating temperature range: $-40^{\circ}\text{C} \sim +125^{\circ}\text{C}$ (Including coil's self temperature rise)

4-3. External appearance : No external defects can be found in the visual inspection.

4-4. Electrode strength : No electrode detachment should be found when the device is pushed in two directions of X and Y with the force of 10.0N for 10 ± 2 seconds after soldering between copper plate and the electrodes.
(Refer to figure at right)

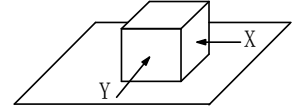

4-5. Vibration test : Inductance deviation is within $\pm 10.0\%$ after 1 hour sweeping vibration in each three directions, namely, forward and backward, up and down, right and left. The frequency is $10 \sim 55 \sim 10\text{Hz}$ and the amplitude of 1 minute cycle is 1.5mm PP.

4-6. Recommended reflow condition:

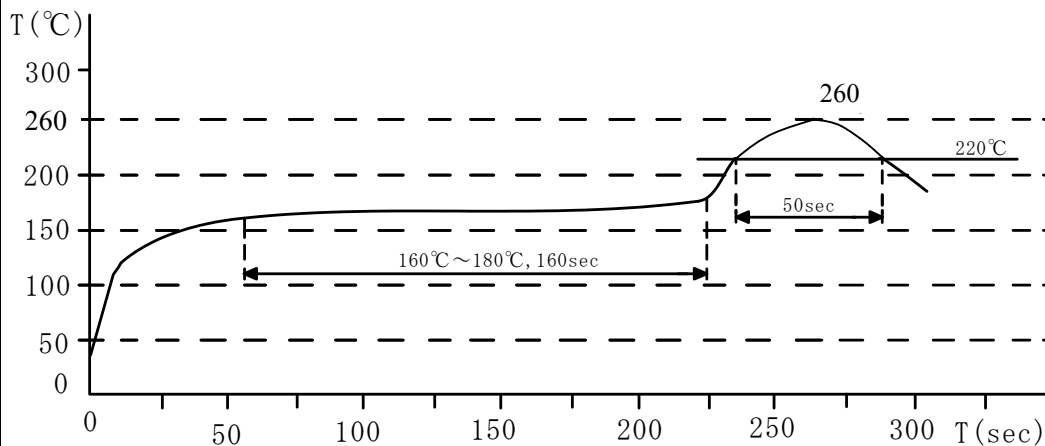

4-7. Humidity test : Inductance deviation is within $\pm 5.0\%$ after 96 ± 4 hours test under the condition of relative humidity of $90 \sim 95\%$ and temperature of $60 \pm 2^{\circ}\text{C}$, and 1 hour storage under room ambient conditions after the device is wiped with dry cloth.



5. PACKAGE SPECIFICATION:

5-1. 3KPCS/ Reel 9KPCS/ Inner Box 27KPCS/ Outer Box

编带方向 , 如下图所示

5-2. MSL: level 1

6.Packaging and Marking:

6-1.Carrier Tape Dimensions:

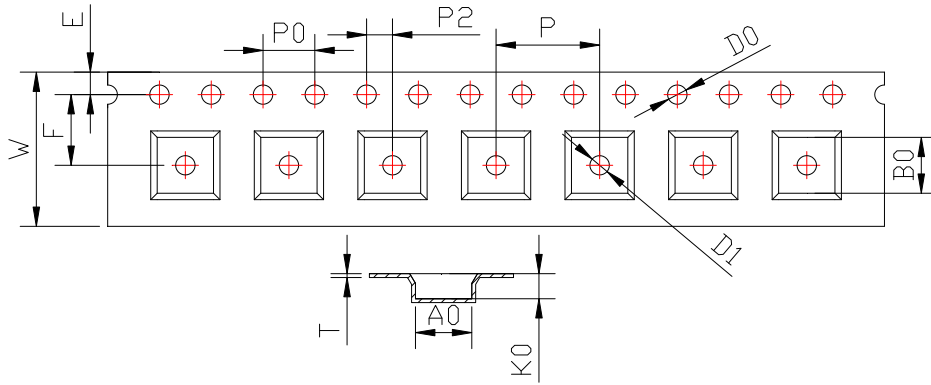

| ITEM | W | A0 | B0 | K0 | P | F | E | D0 | D1 | P0 | P2 | T |
|------|----------------|------|------|------|------|------|------|------|------|------|------|-------|
| DIM | 12.00 | 4.35 | 4.35 | 1.95 | 8.00 | 5.50 | 1.75 | 1.50 | 1.50 | 4.00 | 2.00 | 0.30 |
| TOLE | +0.30 -0.10 | ±0.1 | ±0.1 | ±0.1 | ±0.1 | ±0.1 | ±0.1 | +0.1 | +0.1 | ±0.1 | ±0.1 | ±0.05 |

6-2.Taping Dimensions:

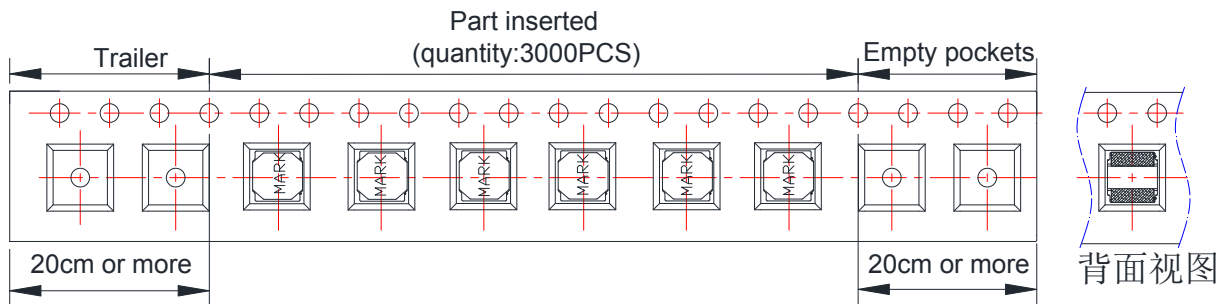

6-3.Reel Dimensions:

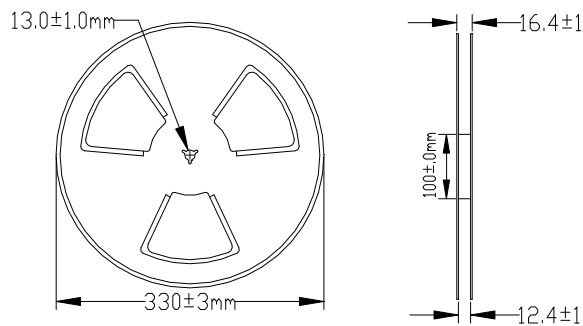

7. Visual Inspection Standard of Product

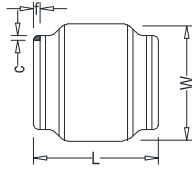
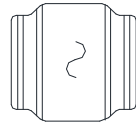
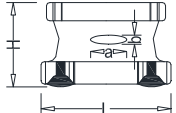
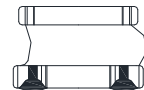
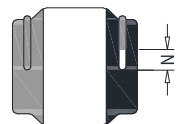
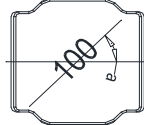
| No. | Defect Item | Figure | Rejection Identification | Acceptance |
|-----|----------------|---|--|------------|
| 1 | Core Defect |  | The defect length(c or f) more than L/6 or W/6 , NG | AQL=0.65 |
| 2 | Core Crack |  | Visual cracks , NG | AQL=0.65 |
| 3 | Starvation |  | (1)Resin starved length a more than L/2, NG (2)When L>2mm,b>H/2, NG (3)When L≤2mm, b don't control | AQL=0.65 |
| 4 | Excessive glue |  | The length, width or height of product beyond specified value, NG | AQL=0.65 |
| 5 | Cold Solder |  | (1)For CR2520** Series , cold solder N>0.5mm,NG (2)For other series, cold solder N>1mm,NG | AQL=0.65 |
| 6 | Marking Defect |  | The marking angle a>45° , NG | AQL=0.65 |

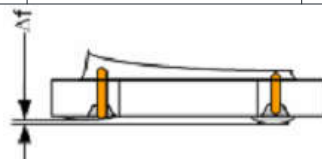

Δf: Clearance between terminal and the surface of plate must be 0.1mm max when coil is placed on a flat plate.

X-ON Electronics

Largest Supplier of Electrical and Electronic Components

Click to view similar products for [Fixed Inductors](#) category:

Click to view products by [Ceaiya](#) manufacturer:

Other Similar products are found below :

[CR32NP-100KC](#) [CR54NP-470LC](#) [70F224AI](#) [MGDQ4-00004-P](#) [MHQ1005P10NJ](#) [MHQ1005P1N0S](#) [MHQ1005P2N4S](#) [MHQ1005P3N6S](#)
[MHQ1005P5N1S](#) [MHQ1005P8N2J](#) [PE-53601NL](#) [PE-53602NL](#) [PG0936.113NLT](#) [9220-20](#) [9310-16](#) [PM06-2N7](#) [PM06-39NJ](#) [A01TK](#)
[1206CS-471XJ](#) [HC2-R47-R](#) [HC8-1R2-R](#) [HCF1305-3R3-R](#) [1206CS-151XG](#) [RCH664NP-140L](#) [RCH664NP-4R7M](#) [RCP1317NP-391L](#)
[RCR110DNP-331L](#) [DH2280-4R7M](#) [DS1608C-106](#) [B10TJ](#) [B82498B3101J000](#) [ELJ-RE27NJF2](#) [1812CS-153XJ](#) [1812CS-183XJ](#) [1812CS-](#)
[223XJ](#) [1812LS-104XJ](#) [1812LS-105XJ](#) [1812LS-124XJ](#) [1812LS-154XJ](#) [1812LS-223XJ](#) [1812LS-224XJ](#) [1812LS-563XJ](#) [1812LS-683XJ](#)
[1812LS-824XJ](#) [NIN-FB101JTR110F](#) [NIN-FB471JTR62F](#) [NIN-FC1R5JTR220F](#) [NIN-HCR15JTRF](#) [NIN-HCR33JTRF](#) [NIN-HDR22JTRF](#)