

## Specification Sheet for Approved

Customer Name:	
Customer Part No.:	
Ceaiya Part No:	CR4018A Series
Spec No:	L418A

### 【For Customer Approval Only】

If you Approval, Please Stamp

### 【RoHS Compliant Parts】

Approved By	Checked By	Prepared By
李庆辉	刘志坚	劳水花

## Shenzhen Ceaiya Electronics Co., Ltd.

地址 1: 深圳市龙华区观湖街道鹭湖社区观盛二路 5 号捷顺科技中心 B706

地址 2: 广东省东莞清溪镇青滨东路 105 号力合紫荆智能制造中心 10 栋

Http://www.szceaiya.com

Tel: 0769-89135516

Fax: 0769-89135519

**【Version of Changed Record】**

<b>Rev.</b>	<b>Effective Date</b>	<b>Changed Contents</b>	<b>Change Reasons</b>	<b>Approved By</b>
A0	2023.05.25	New release	/	Li qing hui

## 1. Shape and Dimension ( Unit:mm )

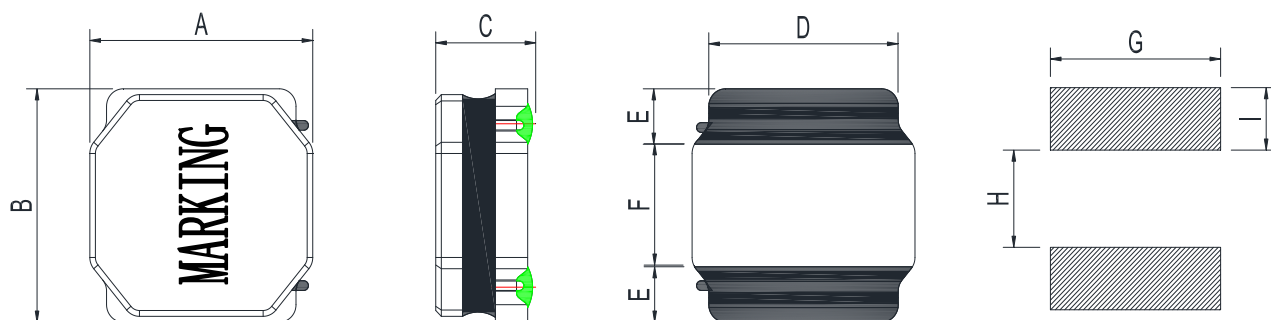

注：喷码尺寸长  $2.5 \pm 0.5$ mm, 宽  $2.0 \pm 0.5$ mm

A	B	C	D	E	F	G	H	I
$4.0 \pm 0.2$	$4.0 \pm 0.2$	1.85Max	$3.3 \pm 0.2$	$1.0 \pm 0.2$	2.0 Ref	3.7 Ref	1.9 Ref	1.1 Ref

## 2. Electronic Characteristics List

Part Number	Inductance (uH)	Tolerance (±%)	DCR(mΩ) ±30%	Isat (A)	Irise (A)	Test Condition	Marking
CR4018A-R47N	0.47	30	18	6.50	4.10	100KHz /1.0V	R47
CR4018A-1R0N	1.0	30	27	4.00	3.20	100KHz /1.0V	1R0
CR4018A-1R5N	1.5	30	37	3.30	2.40	100KHz /1.0V	1R5
CR4018A-2R2M	2.2	20	42	3.00	2.20	100KHz /1.0V	2R2
CR4018A-3R3M	3.3	20	55	2.30	2.00	100KHz /1.0V	3R3
CR4018A-4R7M	4.7	20	70	2.00	1.70	100KHz /1.0V	4R7
CR4018A-6R8M	6.8	20	98	1.60	1.45	100KHz /1.0V	6R8
CR4018A-100M	10	20	150	1.30	1.20	100KHz /1.0V	100
CR4018A-150M	15	20	210	1.10	0.85	100KHz /1.0V	150
CR4018A-220M	22	20	290	0.90	0.72	100KHz /1.0V	220
CR4018A-330M	33	20	480	0.70	0.55	100KHz /1.0V	330
CR4018A-390M	39	20	780	0.68	0.55	100KHz /1.0V	390
CR4018A-470M	47	20	755	0.65	0.60	100KHz /1.0V	470
CR4018A-680M	68	20	1000	0.50	0.50	100KHz /1.0V	680
CR4018A-101M	100	20	1450	0.42	0.28	100KHz /1.0V	101

※ All test data is referenced to 25°C ambient;

**Isat (A) :**

DC Saturation Current that will cause initial inductance to drop approximately 30% max.

**Irise((A)**

DC Current that will cause an approximate  $\Delta T$  of 40 °C

**Measuring Instrument :**

L:HIOKI3532-50

DCR:HIOKI 3540

Isat / Irise:HP4284A+42841

### 3. Construction and materials

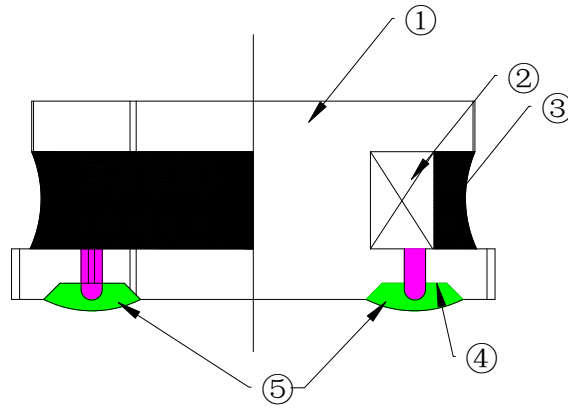

No.	Part name	Material	Ceaiya P/N
①	Drum Core	Ni-Zn Ferrite Core	YN/YX/DYG
②	Wire	Polyurethane enameled copper wire	YLSL
③	Adhesive	Epoxy Resin Magnetic Powder	
④	Plating Electrodes	Plating: Ag 10-20 $\mu\text{m}$ Ni 1-3 $\mu\text{m}$ Sn 3-7 $\mu\text{m}$	
⑤	Outer Electrodes	Top surface solder coating Sn99%、 Ag0.3%、Cu0.7%	YX

## 4. General Characteristics

4-1. Storage Temperature range :  $-40^{\circ}\text{C} \sim +105^{\circ}\text{C}$

4-2. Operating temperature range:  $-40^{\circ}\text{C} \sim +125^{\circ}\text{C}$  (Including coil's self temperature rise)

4-3. External appearance : No external defects can be found in the visual inspection.

4-4. Electrode strength : No electrode detachment should be found when the device is pushed in two directions of X and Y with the force of 10.0N for  $10 \pm 2$  seconds after soldering between copper plate and the electrodes.  
(Refer to figure at right)

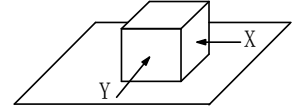

4-5. Vibration test : Inductance deviation is within  $\pm 10.0\%$  after 1 hour sweeping vibration in each three directions, namely, forward and backward, up and down, right and left. The frequency is  $10 \sim 55 \sim 10\text{Hz}$  and the amplitude of 1 minute cycle is 1.5mm PP.

4-6. Recommended reflow condition:

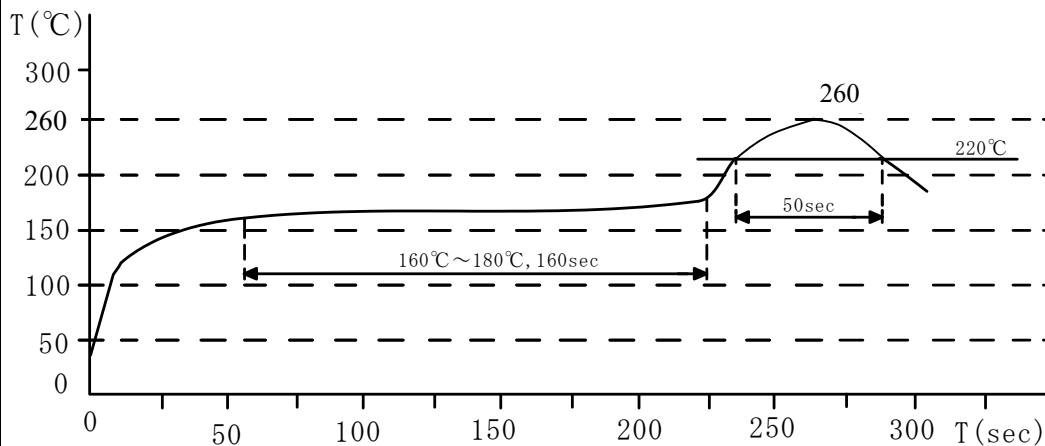

4-7. Humidity test : Inductance deviation is within  $\pm 5.0\%$  after  $96 \pm 4$  hours test under the condition of relative humidity of  $90 \sim 95\%$  and temperature of  $60 \pm 2^{\circ}\text{C}$ , and 1 hour storage under room ambient conditions after the device is wiped with dry cloth.



## 5. PACKAGE SPECIFICATION:

5-1. 3KPCS/ Reel    9KPCS/ Inner Box    27KPCS/ Outer Box

编带方向 , 如下图所示

5-2. MSL: level 1

## 6.Packaging and Marking:

### 6-1.Carrier Tape Dimensions:

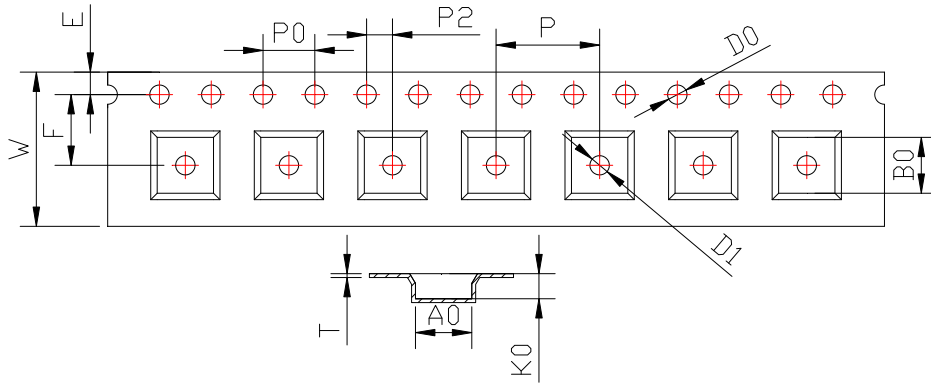

ITEM	W	A0	B0	K0	P	F	E	D0	D1	P0	P2	T
DIM	12.00	4.35	4.35	1.95	8.00	5.50	1.75	1.50	1.50	4.00	2.00	0.30
TOLE	+0.30 -0.10	±0.1	±0.1	±0.1	±0.1	±0.1	±0.1	+0.1	+0.1	±0.1	±0.1	±0.05

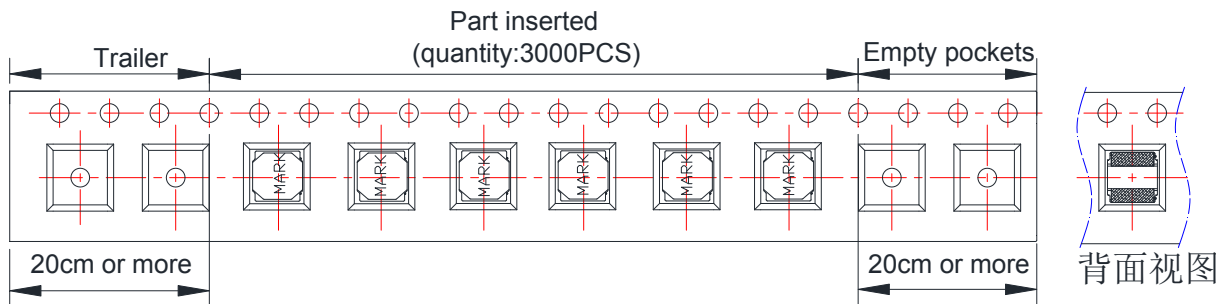

### 6-2.Taping Dimensions:

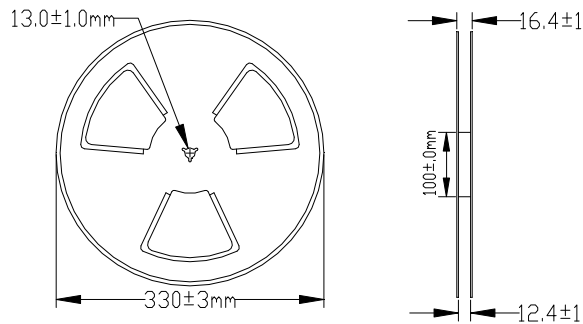

### 6-3.Reel Dimensions:

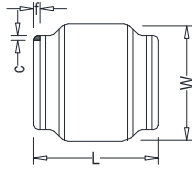
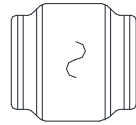
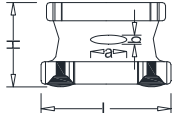

## 7. Visual Inspection Standard of Product

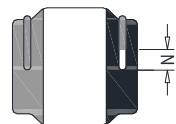
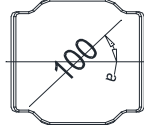
No.	Defect Item	Figure	Rejection Identification	Acceptance
1	Core Defect		The defect length(c or f) more than L/6 or W/6 , NG	AQL=0.65
2	Core Crack		Visual cracks , NG	AQL=0.65
3	Starvation		(1)Resin starved length a more than L/2, NG (2)When L>2mm,b>H/2, NG (3)When L≤2mm, b don't control	AQL=0.65
4	Excessive glue		The length, width or height of product beyond specified value, NG	AQL=0.65
5	Cold Solder		(1)For CR2520** Series , cold solder N>0.5mm,NG (2)For other series, cold solder N>1mm,NG	AQL=0.65
6	Marking Defect		The marking angle a>45° , NG	AQL=0.65

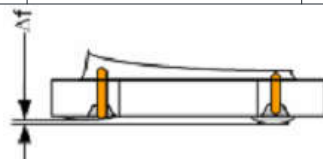

Δf: Clearance between terminal and the surface of plate must be 0.1mm max when coil is placed on a flat plate.

## X-ON Electronics

Largest Supplier of Electrical and Electronic Components

*Click to view similar products for [Fixed Inductors](#) category:*

*Click to view products by [Ceaiya](#) manufacturer:*

Other Similar products are found below :

[CR32NP-100KC](#) [CR54NP-470LC](#) [70F224AI](#) [MGDQ4-00004-P](#) [MHQ1005P10NJ](#) [MHQ1005P1N0S](#) [MHQ1005P2N4S](#) [MHQ1005P3N6S](#)  
[MHQ1005P5N1S](#) [MHQ1005P8N2J](#) [PE-53601NL](#) [PE-53602NL](#) [PG0936.113NLT](#) [9220-20](#) [9310-16](#) [PM06-2N7](#) [PM06-39NJ](#) [A01TK](#)  
[1206CS-471XJ](#) [HC2-R47-R](#) [HC8-1R2-R](#) [HCF1305-3R3-R](#) [1206CS-151XG](#) [RCH664NP-140L](#) [RCH664NP-4R7M](#) [RCP1317NP-391L](#)  
[RCR110DNP-331L](#) [DH2280-4R7M](#) [DS1608C-106](#) [B10TJ](#) [B82498B3101J000](#) [ELJ-RE27NJF2](#) [1812CS-153XJ](#) [1812CS-183XJ](#) [1812CS-](#)  
[223XJ](#) [1812LS-104XJ](#) [1812LS-105XJ](#) [1812LS-124XJ](#) [1812LS-154XJ](#) [1812LS-223XJ](#) [1812LS-224XJ](#) [1812LS-563XJ](#) [1812LS-683XJ](#)  
[1812LS-824XJ](#) [NIN-FB101JTR110F](#) [NIN-FB471JTR62F](#) [NIN-FC1R5JTR220F](#) [NIN-HCR15JTRF](#) [NIN-HCR33JTRF](#) [NIN-HDR22JTRF](#)