

Specification Sheet for Approved

Customer Name:	
Customer Part No.:	
Ceaiya Part No:	CR5020 Series
Spec No:	L099-1

【For Customer Approval Only】

If you Approval, Please Stamp

【RoHS Compliant Parts】

Approved By	Checked By	Prepared By
李庆辉	刘志坚	劳水花

Shenzhen Ceaiya Electronics Co., Ltd.

地址 1: 深圳市龙华区观湖街道鹭湖社区观盛二路 5 号捷顺科技中心 B706

地址 2: 广东省东莞清溪镇青滨东路 105 号力合紫荆智能制造中心 10 栋

Http://www.szceaiya.com

Tel: 0769-89135516

Fax: 0769-89135519

1. Shape and Dimension (Unit:mm)

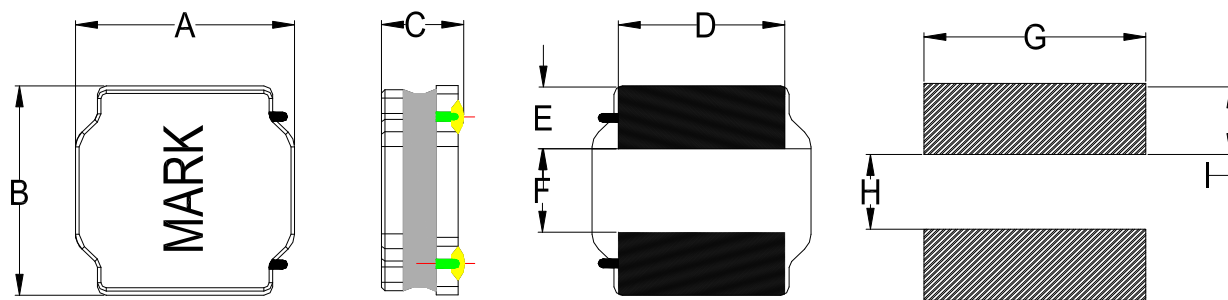

A	B	C	D	E	F	G	H	I
5.0 ± 0.2	5.0 ± 0.2	2.2Max	4.0±0.3	1.3±0.3	2.4±0.3	4.2 Ref	2.3 Ref	1.4 Ref

注：喷码尺寸：长 3.4±0.4mm,宽 2.2±0.4mm

2. Electronic Characteristics List

Part Number	Inductance (uH)	Tolerance (±%)	DCR(mΩ) ±30%	Isat (A)	Irise (A)	Test Condition	Marking
CR5020-R22N	0.22	30	11	8.00	5.00	100KHz /0.25V	R22
CR5020-R24N	0.24	30	11	8.00	5.00	100KHz /0.25V	R24
CR5020-R33N	0.33	30	15	7.50	4.60	100KHz /0.25V	R33
CR5020-R47N	0.47	30	15	6.15	4.60	100KHz /0.25V	R47
CR5020-1R0N	1.0	30	20	4.33	3.70	100KHz /0.25V	1R0
CR5020-1R2N	1.2	30	25	4.20	3.50	100KHz /0.25V	1R2
CR5020-1R5N	1.5	30	26	4.10	3.20	100KHz /0.25V	1R5
CR5020-1R8N	1.8	30	30	4.00	3.00	100KHz /0.25V	1R8
CR5020-2R2N	2.2	30	38	3.85	2.90	100KHz /0.25V	2R2
CR5020-2R7N	2.7	30	45	3.50	2.40	100KHz /0.25V	2R7
CR5020-3R3N	3.3	30	46	3.25	2.40	100KHz /0.25V	3R3
CR5020-3R6N	3.6	30	48	2.90	2.30	100KHz /0.25V	3R6
CR5020-3R9N	3.9	30	50	2.90	2.15	100KHz /0.25V	3R9
CR5020-4R7M	4.7	20	65	2.40	2.05	100KHz /0.25V	4R7
CR5020-5R6M	5.6	20	72	2.30	1.85	100KHz /0.25V	5R6
CR5020-6R8M	6.8	20	92	2.10	1.70	100KHz /0.25V	6R8
CR5020-8R2M	8.2	20	100	1.90	1.60	100KHz /0.25V	8R2
CR5020-100M	10	20	125	1.80	1.50	100KHz /0.25V	100
CR5020-150M	15	20	180	1.44	1.25	100KHz /0.25V	150
CR5020-220M	22	20	250	1.18	1.05	100KHz /0.25V	220
CR5020-270M	27	20	300	1.10	1.00	100KHz /0.25V	270
CR5020-330M	33	20	370	0.97	0.83	100KHz /0.25V	330
CR5020-470M	47	20	560	0.81	0.70	100KHz /0.25V	470
CR5020-680M	68	20	850	0.70	0.53	100KHz /0.25V	680
CR5020-820M	82	20	950	0.65	0.50	100KHz /0.25V	820
CR5020-101M	100	20	1100	0.57	0.43	100KHz /0.25V	101
CR5020-151M	150	20	1500	0.41	0.40	100KHz /0.25V	151
CR5020-221M	220	20	2230	0.35	0.30	100KHz /0.25V	221

※ All test data is referenced to 25°C ambient;

Isat : DC Saturation Current that will cause initial inductance to drop approximately 30% max.

Irise : DC Current that will cause an approximate ΔT of 40 °C

Measuring Instrument :

L:HIOKI3532-50

DCR:HIOKI 3540

Isat / Irise:HP4284A+42841

3. General Characteristics

3-1. Storage Temperature range : $-40^{\circ}\text{C} \sim +105^{\circ}\text{C}$

3-2. Operating temperature range: $-40^{\circ}\text{C} \sim +125^{\circ}\text{C}$ (Including coil's self temperature rise)

3-3. External appearance : No external defects can be found in the visual inspection.

3-4. Electrode strength : No electrode detachment should be found when the device is pushed in two directions of X and Y with the force of 10.0N for 60 ± 2 seconds after soldering between copper plate and the electrodes.
(Refer to figure at right)

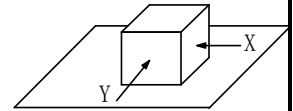

3-5. Vibration test : Inductance deviation is within $\pm 10.0\%$ after 1 hour sweeping vibration in each three directions, namely, forward and backward, up and down, right and left. The frequency is $10 \sim 55 \sim 10\text{Hz}$ and the amplitude of 1 minute cycle is 1.5mm PP.

3-6. Recommended reflow condition:

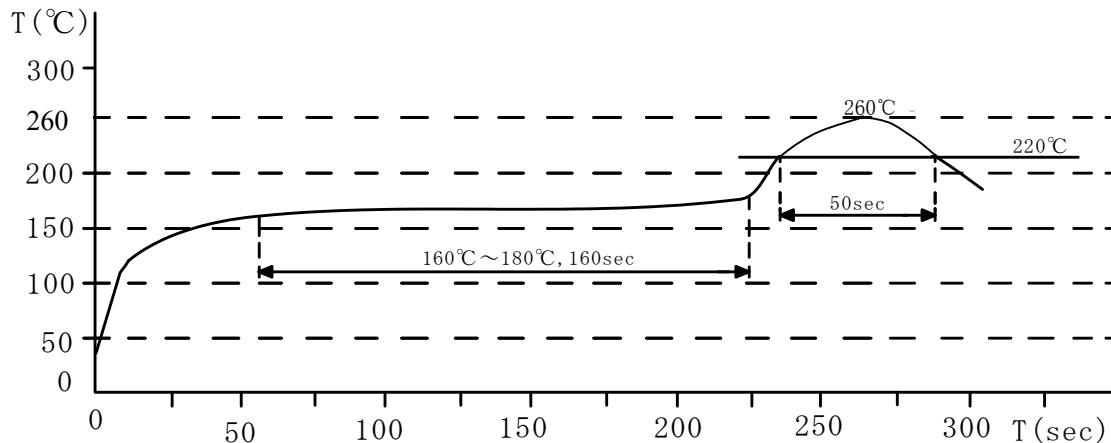

3-7. Humidity test : Inductance deviation is within $\pm 5.0\%$ after 96 ± 4 hours test under the condition of relative humidity of $90 \sim 95\%$ and temperature of $60 \pm 2^{\circ}\text{C}$, and 1 hour storage under room ambient conditions after the device is wiped with dry cloth.



4. Construction and materials

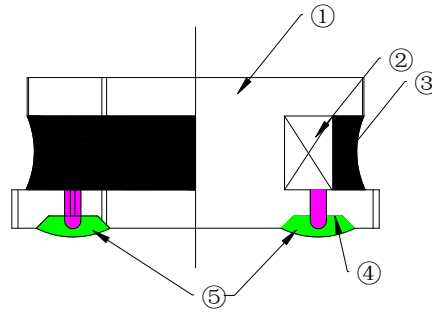

No.	Part name	Material	Ceaiya P/N
①	Drum Core	Ni-Zn Ferrite Core	TW/CY/MT
②	Wire	Polyurethane enameled copper wire	YLSL
③	Adhesive	Epoxy Resin Magnetic Powder	
④	Plating Electrodes	Plating: Ag 3-7 μ m Ni 1-3 μ m Sn 3-7 μ m	
⑤	Outer Electrodes	Top surface solder coating Sn99%、 Ag0.3%、Cu0.7%	YX

5.Package Specification

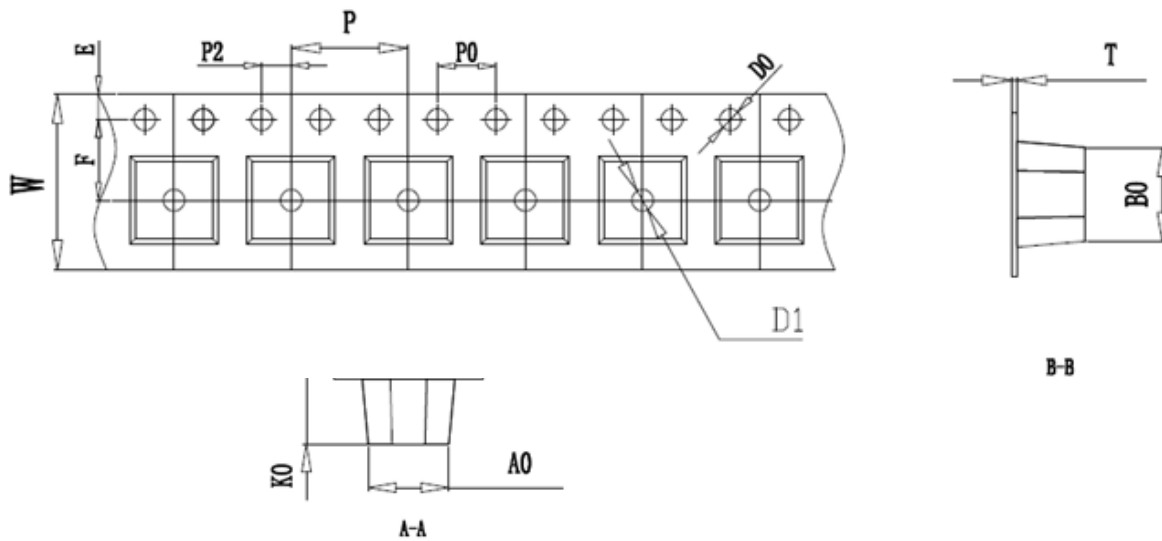

ITEM	W	A0	B0	K0	P	F	E	D0	P0	P2	T
DIM	12.00	5.4	5.4	2.2	8.00	5.50	1.75	1.50	4.00	2.00	0.35
TOLE	± 0.3	± 0.1	± 0.1	± 0.1	± 0.1	± 0.15	± 0.1	+0.1	± 0.1	± 0.1	± 0.05

6. CARRIER REEL DIMENSIONS:

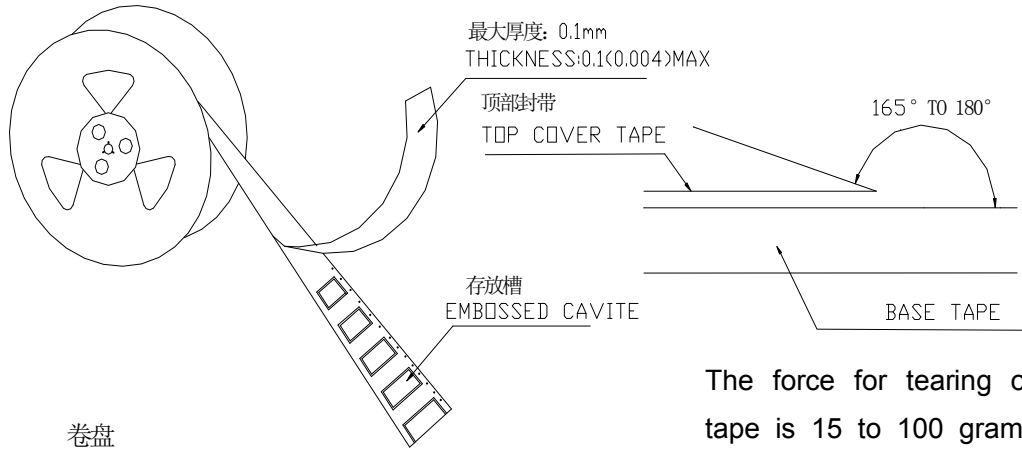

卷盘
Carrier Tape Reel

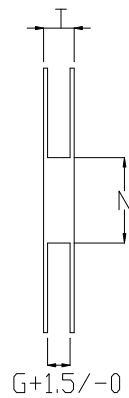
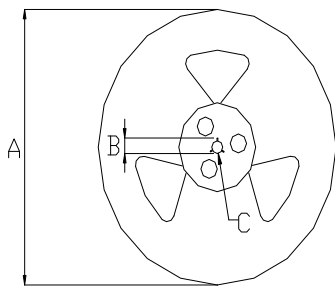

The force for tearing off cover tape is 15 to 100 grams in the arrow direction/按箭头的方向施加 15 克至 100 克力撕开

Unit: mm

Type	A	B	C	G	N	T
12mm	330	21±0.8	13±0.4	12.4	100	16.4

7. PACKAGE SPECIFICATION :

3KPCS/Reel 9KPCS/Inner Box 27KPCS/Outer Box

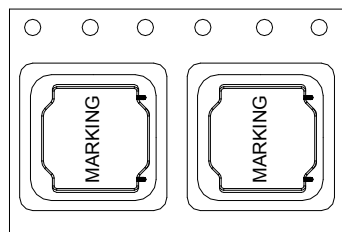

Visual Inspection Standard of Product

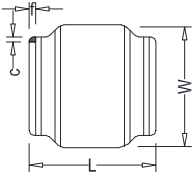
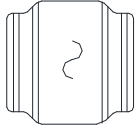
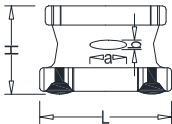
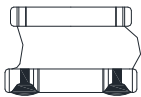
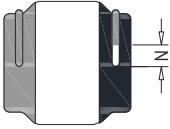
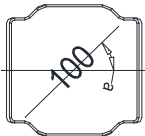
No.	Defect Item	Figure	Rejection Identification	Acceptance
1	Core Defect		The defect length(c or f) more than L/6 or W/6 , NG	AQL=0.65
2	Core Crack		Visual cracks , NG	AQL=0.65
3	Starvation		(1)Resin starved length a more than L/2, NG (2)When L>2mm,b>H/2, NG (3)When L≤2mm, b don't control	AQL=0.65
4	Excessive glue		The length, width or height of product beyond specified value, NG	AQL=0.65
5	Cold Solder		(1)For CR2520** Series , cold solder N>0.5mm,NG (2)For other series, cold solder N>1mm,NG	AQL=0.65
6	Marking Defect		The marking angle a>45° , NG	AQL=0.65

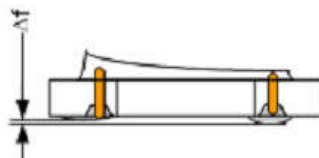

Δf: Clearance between terminal and the surface of plate must be 0.2mm max when coil is placed on a flat plate.

X-ON Electronics

Largest Supplier of Electrical and Electronic Components

Click to view similar products for [Fixed Inductors](#) category:

Click to view products by [Ceaiya](#) manufacturer:

Other Similar products are found below :

[CR32NP-100KC](#) [CR54NP-470LC](#) [70F224AI](#) [MGDQ4-00004-P](#) [MHQ1005P10NJ](#) [MHQ1005P1N0S](#) [MHQ1005P2N4S](#) [MHQ1005P3N6S](#)
[MHQ1005P5N1S](#) [MHQ1005P8N2J](#) [PE-53601NL](#) [PE-53602NL](#) [PG0936.113NLT](#) [9220-20](#) [9310-16](#) [PM06-2N7](#) [PM06-39NJ](#) [A01TK](#)
[1206CS-471XJ](#) [HC2-R47-R](#) [HC8-1R2-R](#) [HCF1305-3R3-R](#) [1206CS-151XG](#) [RCH664NP-140L](#) [RCH664NP-4R7M](#) [RCP1317NP-391L](#)
[RCR110DNP-331L](#) [DH2280-4R7M](#) [DS1608C-106](#) [B10TJ](#) [B82498B3101J000](#) [ELJ-RE27NJF2](#) [1812CS-153XJ](#) [1812CS-183XJ](#) [1812CS-](#)
[223XJ](#) [1812LS-104XJ](#) [1812LS-105XJ](#) [1812LS-124XJ](#) [1812LS-154XJ](#) [1812LS-223XJ](#) [1812LS-224XJ](#) [1812LS-563XJ](#) [1812LS-683XJ](#)
[1812LS-824XJ](#) [NIN-FB101JTR110F](#) [NIN-FB471JTR62F](#) [NIN-FC1R5JTR220F](#) [NIN-HCR15JTRF](#) [NIN-HCR33JTRF](#) [NIN-HDR22JTRF](#)