

电感、变压器一流供应商  
Inductors, transformers first-class suppliers

深圳市柯爱亚电子有限公司

SHENZHEN CEAIYA ELECTRONICS CO.,LTD.

淮安市柯爱亚电子有限公司

HUAIAN CEAIYA ELECTRONICS CO.,LTD.

Add: 深圳市观兰镇环观中路66号

Tel: 0755-2799 3000 2799 3488

Fax: 0755-2799 3067

Http://www.ceaiya.com

E-mail:ceaiya@vip.163.com

**ceaiya**  
柯爱亚

2014  
www.ceaiya.com

**PRODUCT  
CATALOG**

**RoHS**  
Compliance

深圳市柯爱亚电子有限公司  
SHENZHEN CEAIYA ELECTRONICS CO.,LTD.

电感、变压器一流供应商  
Inductors, transformers first-class suppliers

www.ceaiya.com



# 2014 PRODUCT CATALOG

深圳市柯爱亚电子有限公司

SHENZHEN CEAIYA ELECTRONICS CO.,LTD.

淮安市柯爱亚电子有限公司

HUAIAN CEAIYA ELECTRONICS CO.,LTD.

Add: 深圳市观兰镇环观中路66号

Tel: 0755-2799 3000 2799 3488

Fax: 0755-2799 3067

Http://www.ceaiya.com

E-mail:ceaiya@vip.163.com



深圳市柯爱亚电子有限公司  
SHENZHEN CEAIYA ELECTRONICS CO.,LTD.

电感、变压器一流供应商  
Inductors, transformers first-class suppliers

[www.ceaiya.com](http://www.ceaiya.com)



# 2014 产·品·目·录

P R O D U C T C A T A L O G

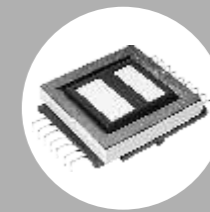
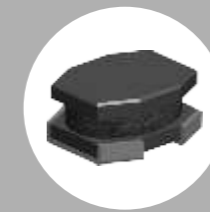

深圳市柯爱亚电子有限公司  
SHENZHEN CEAIYA ELECTRONICS CO.,LTD.

淮安市柯爱亚电子有限公司  
HUAIAN CEAIYA ELECTRONICS CO.,LTD.

Add: 深圳市观兰镇环观中路66号

Tel: 0755-2799 3000 2799 3488

Fax: 0755-2799 3067

Http://www.ceaiya.com

E-mail: ceaiya@vip.163.com



深圳市柯爱亚电子有限公司  
SHENZHEN CEAIYA ELECTRONICS CO.,LTD.



电感、变压器一流供应商  
Inductors, transformers first-class suppliers

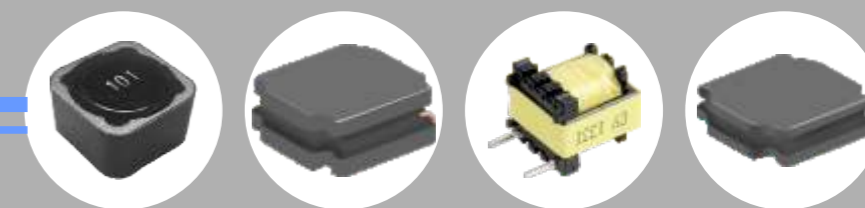

# 2014产品目录 PRODUCT CATALOG

[www.ceaiya.com](http://www.ceaiya.com)

深圳市柯爱亚电子有限公司

SHENZHEN CEAIYA ELECTRONICS CO.,LTD.

淮安市柯爱亚电子有限公司

HUAIAN CEAIYA ELECTRONICS CO.,LTD.

Add: 深圳市观兰镇环观中路66号

Tel: 0755-2799 3000 2799 3488

Fax: 0755-2799 3067

Http://www.ceaiya.com

E-mail:ceaiya@vip.163.com



深圳市柯爱亚电子有限公司  
SHENZHEN CEAIYA ELECTRONICS CO.,LTD.

# 公司简介 Company Introduction

1998年深圳市柯爱亚电子有限公司成立，专业从事功率电感，变压器研发、生产；2004年淮安市柯爱亚电子有限公司成立，目前公司厂房15000平米，员工1500人（其中工程技术人员100余人），月产量40KK,年营业额2亿。

2010年起，我们潜心于自动化技术的进步，投入千万元，形成十条功率电感、变压器自动化生产线，效率提高50%以上。付出总有回报，大规模的制造能力，稳定的品质水准，领先的专业技术，我们成为国内外一批著名企业(HISENSE,CHANGHONG,SKYWORTH,TCL,OPPO,FOXCONN)的合作伙伴。

坚持改进，创新的工作方法，坚持诚实，永续的经营思想，坚持追求更好的服务理念。

柯爱亚人，秉着工作付出不亚于任何人的生活态度，努力争取成为国际大厂供应链中的一员。

Shenzhen Keaiya Electronics Co., Ltd. was established in 1998. It is a professional company engaged in developing and manufacturing power inductors, transformers, as well as high current molding inductors. In the year of 2004, Huaian Keaiya Electronics Co., Ltd. was founded. Until now it covers 15000 square meters and has staff of 1500 people, including over 100 R & D engineers and technicians, with a monthly output reached up to 40 million and a annual turnover of 200 million.

Since 2010, we have made good efforts in automated manufacturing. Having an investment of nearly 10 million, we have developed ten automated production lines of power inductors and transformers, which increases the efficiency by 50 %. What comes around goes around. Relying on large-scale automated manufacturing, high quality and advanced technology, we are honored to be partner with the famous companies at household appliance and broad, such as HISENSE, CHANGHONG, SKYWORTH, TCL, OPPO and FOXCONN.

Insisting on innovational working way and sincere business idea, we are always pursuing better services for our customers. Never lagging behind others, all our members of Keaiya are working hard, in the hope of being a member of international supply chain.

## Contents

■ Coils /Inductors	
● SMD Power Inductors	
CR Series	
CR25Series.....	1-2
CR30Series.....	3-4
CR40Series.....	5-7
CR50Series.....	8-9
CR60Series.....	10-11
CR80Series.....	12
SHI Series	
SHI0402.....	13-14
SHI0515.....	13-14
SHI0603.....	13-14
CD Series	
CD43 Series.....	15-16
CD54 Series.....	17
CD75 Series.....	18
CD105 Series.....	19-20
CDH Series	
CDH6B Series.....	21-22
CDH8B Series.....	23-24
CDH103R Series.....	25-26
CDH104R Series.....	26
CDH105R Series.....	27
CDH12 Series.....	28-30
BF Series	
BF1608.....	31-32
BF3316.....	31-32
BF5022.....	31-32
B Series	
B1608.....	33-34
B3316.....	33-34
B3340.....	35-36
B5022.....	35-36
● SMD Wire Wound Ferrite Common Mode Choke	
CM Series.....	37
PCM Series.....	38
TCM Series.....	38
● SMD Wire Wound Chip Ceramic Inductors	
WIC1005 Series.....	44
WIC1608 Series.....	44-46
WIC2012 Series.....	46
WIC2520 Series.....	47
● SMD Wire Wound Chip Ferrite Inductors	
WIF2520 Series.....	49
WIF3225 Series.....	49-50
WIF4532 Series.....	50
■ Coils /Transformers	
● EE Series	
EE10 .....	50
EE13.....	51

## Wound Ferrite SMD Inductor for Power Circuit-----CR Series

Operating Temp. : -40°C~125°C(including self-heating)



### Feature

- Metallization on ferrite core result in excellent thermal shock.
- Magnetic-resin shielded construction reduce buzz noise to ultra-low levels
- Closed magnetic circuit design reduces leakage flux and excellent for EMI

### Application

- Smart phone, MID, table terminal , HDDs ,DSCs , VRMs
- Set Top Boxes, Mobile Power
- Portable gaming device , navigation systems

### Production identification

CR 252012 6R8 M T  
① ② ③ ④ ⑤

① CR  
Series Name

③ Inductance value  
6R8 -----> 6.8uH  
100----->10uH

④ Inductance Tolerance  
K-----> ± 10%  
M-----> ± 20%  
N-----> ± 30%

⑤ Packing Type  
T---->Tape Carrier Package

② External Dimensions (L x W x H.) [Unit: mm]	
252010	2.5 x 2.0 x 1.0
252012	2.5 x 2.0 x 1.2
3010	3.0 x 3.0 x 1.0
3012	3.0 x 3.0 x 1.2
3015	3.0 x 3.0 x 1.5
4012	4.0 x 4.0 x 1.35
4015	4.0 x 4.0 x 1.65
4018	4.0 x 4.0 x 1.85
4020	4.0 x 4.0 x 2.0
4030	4.0 x 4.0 x 3.0
5015	5.0 x 5.0 x 1.5
5020	5.0 x 5.0 x 2.0
5030	5.0 x 5.0 x 3.0
5040	5.0 x 5.0 x 4.0
6015	6.0 x 6.0 x 1.5
6020	6.0 x 6.0 x 2.0
6028	6.0 x 6.0 x 3.0
6045	6.0 x 6.0 x 4.5
8040	8.0 x 8.0 x 4.2

### ※CR2 Series

Shape and Dimension (Unit:mm)

Recommended Land Pattern

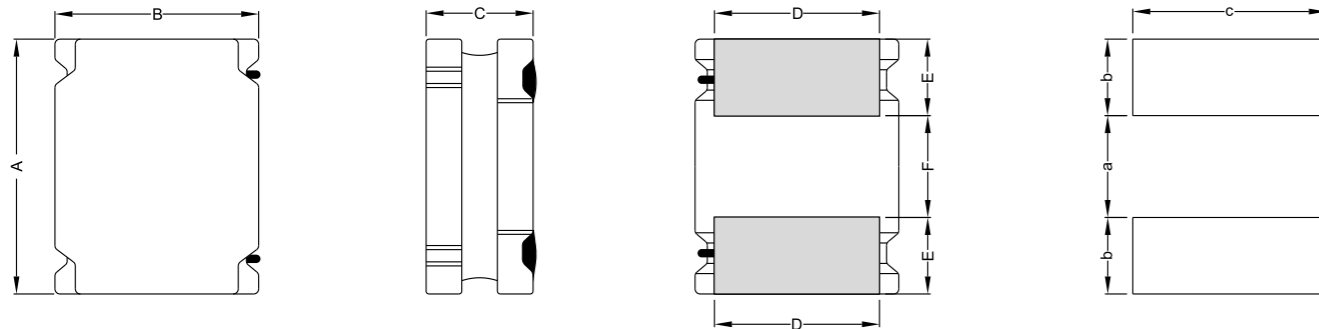

Series	A	B	C	D	E	F	a Typ.	b Typ.	c Typ.
CR252010	2.5±0.1	2.0±0.1	1.0Max.	1.5±0.2	0.80±0.2	0.80±0.2	0.80	0.85	2.0
CR252012	2.5±0.1	2.0±0.1	1.2Max.	1.5±0.2	0.80±0.2	0.80±0.2	0.80	0.85	2.0

## Wound Ferrite SMD Inductor for Power Circuit-----CR Series

Operating Temp. : -40°C~125°C(including self-heating)

### Electronic Characteristics List

Part Number	Inductance (uH)	Tolerance (±%)	DCR(mΩ) ±25%	Isat (A)		Irise(A)	Test Condition
				Max	Typ		
CR252010-1R0N	1.0	30	90	1.85	2.20	1.65	100KHz /0.25V
CR252010-1R5M	1.5	20	152	1.80	2.10	1.30	100KHz /0.25V
CR252010-2R2M	2.2	20	174	1.20	1.60	1.20	100KHz /0.25V
CR252010-3R3M	3.3	20	273	1.05	1.30	0.90	100KHz /0.25V
CR252010-4R7M	4.7	20	469	0.95	1.15	0.70	100KHz /0.25V
CR252010-6R8M	6.8	20	747	0.78	0.92	0.59	100KHz /0.25V
CR252010-100M	10	20	910	0.65	0.78	0.50	100KHz /0.25V
CR252012-1R0N	1.0	30	85	2.68	3.00	1.58	100KHz /0.25V
CR252012-1R5M	1.5	20	113	2.24	2.51	1.40	100KHz /0.25V
CR252012-2R2M	2.2	20	165	1.85	2.07	1.15	100KHz /0.25V
CR252012-3R3M	3.3	20	200	1.61	1.80	1.04	100KHz /0.25V
CR252012-4R7M	4.7	20	315	1.18	1.32	0.84	100KHz /0.25V
CR252012-6R8M	6.8	20	447	0.98	1.10	0.69	100KHz /0.25V
CR252012-8R2M	8.2	20	506	0.92	1.00	0.65	100KHz /0.25V
CR252012-100M	10	20	575	0.88	0.97	0.62	100KHz /0.25V

#### Isat (A):

The saturation current value (Isat) is the DC current value having inductance decrease down to 30%(at 20°C).

#### Irise (A)

The temperature rise current value (Irise) is the DC current having temperature increase up to 40°C(at 20°C).

## Wound Ferrite SMD Inductor for Power Circuit-----CR Series

Operating Temp. : -40°C~125°C(including self-heating)



### ※CR3 Series

Shape and Dimension (Unit:mm)

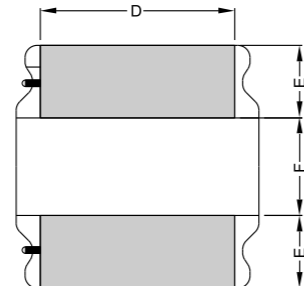
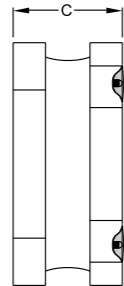
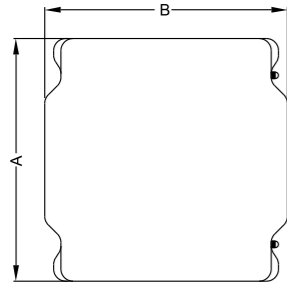

Recommended Land Pattern

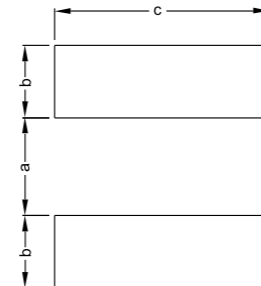

Series	A	B	C	D	E	F	a Typ.	b Typ.	c Typ.
CR3010	3.0±0.2	3.0±0.2	1.0Max	2.5±0.2	2.5±0.2	1.5±0.2	2.7	1.5	0.8
CR3012	3.0±0.2	3.0±0.2	1.2Max	2.5±0.2	2.5±0.2	1.5±0.2	2.7	1.5	0.8
CR3015	3.0±0.2	3.0±0.2	1.5Max	2.5±0.2	2.5±0.2	1.5±0.2	2.7	1.5	0.8
CR3018	3.0±0.2	3.0±0.2	1.85Max	2.5±0.2	2.5±0.2	1.5±0.2	2.7	1.5	0.8
CR3020	3.0±0.2	3.0±0.2	2.00Max	2.5±0.2	2.5±0.2	1.5±0.2	2.7	1.5	0.8
CR3021	3.0±0.2	3.0±0.2	2.35Max	2.5±0.2	2.5±0.2	1.5±0.2	2.7	1.5	0.8

### Electronic Characteristics List

Part Number	Inductance (uH)	Tolerance (±%)	DCR(mΩ) ±25%	Isat (A)	Irise(A)	Test Condition
CR3010-1R0N	1.0	30	65	1.40	1.45	100KHz /0.25V
CR3010-1R2N	1.2	30	65	1.25	1.45	100KHz /0.25V
CR3010-1R5N	1.5	30	80	1.27	1.30	100KHz /0.25V
CR3010-2R2N	2.2	30	110	1.15	1.09	100KHz /0.25V
CR3010-2R7N	2.7	30	130	1.00	1.02	100KHz /0.25V
CR3010-3R3N	3.3	30	145	0.97	0.96	100KHz /0.25V
CR3010-3R6M	3.6	20	165	0.95	0.90	100KHz /0.25V
CR3010-4R7M	4.7	20	225	0.75	0.77	100KHz /0.25V
CR3010-6R8M	6.8	20	305	0.55	0.66	100KHz /0.25V
CR3010-100M	10	20	400	0.55	0.58	100KHz /0.25V
CR3010-120M	12	20	505	0.43	0.52	100KHz /0.25V
CR3010-150M	15	20	610	0.42	0.47	100KHz /0.25V
CR3010-220M	22	20	930	0.35	0.38	100KHz /0.25V
CR3012-R47N	0.47	30	33	2.20	2.20	100KHz /0.25V
CR3012-R82N	0.82	30	40	2.05	2.10	100KHz /0.25V
CR3012-1R0N	1.0	30	48	1.90	2.00	100KHz /0.25V
CR3012-1R5N	1.5	30	55	1.62	1.85	100KHz /0.25V
CR3012-2R2M	2.2	20	75	1.20	1.55	100KHz /0.25V
CR3012-3R3M	3.3	20	100	1.05	1.35	100KHz /0.25V
CR3012-4R7M	4.7	20	120	0.90	1.25	100KHz /0.25V
CR3012-6R8M	6.8	20	190	0.75	1.00	100KHz /0.25V
CR3012-100M	10	20	265	0.60	0.89	100KHz /0.25V
CR3012-150M	15	20	430	0.45	0.72	100KHz /0.25V
CR3012-220M	22	20	630	0.42	0.55	100KHz /0.25V

## Wound Ferrite SMD Inductor for Power Circuit-----CR Series

Operating Temp. : -40°C~125°C(including self-heating)

Part Number	Inductance (uH)	Tolerance (±%)	DCR(mΩ) ±25%	Isat (A)	Irise(A)	Test Condition
CR3015-1R0N	1.0	30	37	2.32	2.10	100KHz /0.25V
CR3015-1R5N	1.5	30	50	2.00	1.70	100KHz /0.25V
CR3015-2R2N	2.2	30	60	1.60	1.60	100KHz /0.25V
CR3015-3R3M	3.3	20	80	1.32	1.36	100KHz /0.25V
CR3015-4R7M	4.7	20	125	1.10	1.09	100KHz /0.25V
CR3015-6R8M	6.8	20	200	0.85	0.85	100KHz /0.25V
CR3015-100M	10	20	250	0.72	0.77	100KHz /0.25V
CR3015-220M	22	20	460	0.52	0.57	100KHz /0.25V

#### Isat (A):

The saturation current value (Isat) is the DC current value having inductance decrease down to 30%(at 20°C).

#### Irise(A)

The temperature rise current value (Irise) is the DC current having temperature increase up to 40°C(at 20°C)

#### Remarks:

With the series of other highly products have been improved

同系列其他高度的产品已在完善中

## Wound Ferrite SMD Inductor for Power Circuit-----CR Series

Operating Temp. : -40°C~125°C(including self-heating)



### ※CR4 Series

Shape and Dimension (Unit:mm)

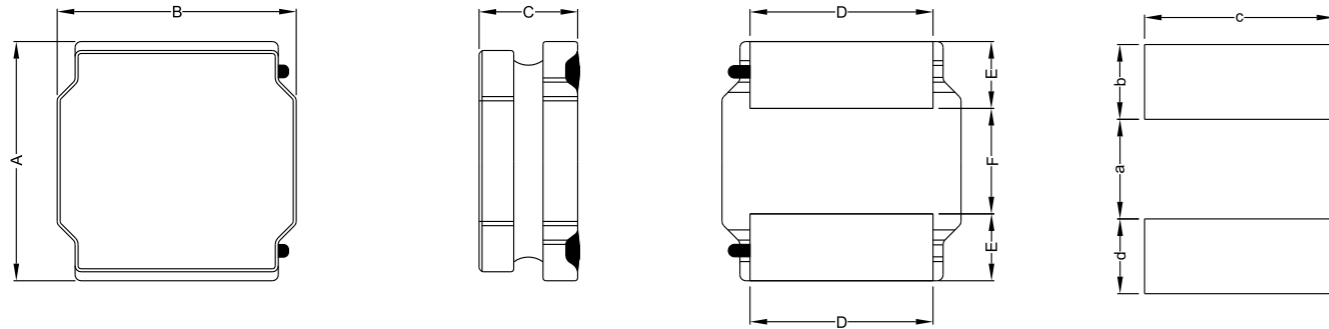

Recommended Land Pattern

Series	A	B	C	D	E	F	a Typ.	b Typ.	c Typ.
CR4010	4.0±0.2	4.0±0.2	1.0Max	3.3±0.2	0.95±0.2	2.1±0.2	3.7	1.9	1.1
CR4012	4.0±0.2	4.0±0.2	1.2Max	3.3±0.2	0.95±0.2	2.1±0.2	3.7	1.9	1.1
CR4015	4.0±0.2	4.0±0.2	1.65Max	3.3±0.2	0.95±0.2	2.1±0.2	3.7	1.9	1.1
CR4018	4.0±0.2	4.0±0.2	1.8Max	3.3±0.2	0.95±0.2	2.1±0.2	3.7	1.9	1.1
CR4020	4.0±0.2	4.0±0.2	2.0Max	3.3±0.2	0.95±0.2	2.1±0.2	3.7	1.9	1.1
CR4030	4.0±0.2	4.0±0.2	3.0Max	3.3±0.2	0.95±0.2	2.1±0.2	3.7	1.9	1.1
CR4032	4.0±0.2	4.0±0.2	3.50Max	3.3±0.2	0.95±0.2	2.1±0.2	3.7	1.9	1.1

### Electronic Characteristics List

Part Number	Inductance (uH)	Tolerance (±%)	DCR(mΩ) ±25%	Isat (A)	Irise(A)	Test Condition
CR4010-1R0N	1.0	30	56	2.00	1.90	100KHz /0.25V
CR4010-1R5N	1.5	30	70	1.68	1.70	100KHz /0.25V
CR4010-2R2M	2.2	20	85	1.20	1.50	100KHz /0.25V
CR4010-3R3M	3.3	20	100	1.10	1.40	100KHz /0.25V
CR4010-4R7M	4.7	20	140	0.95	1.20	100KHz /0.25V
CR4010-6R8M	6.8	20	200	0.80	1.00	100KHz /0.25V
CR4010-100M	10	20	300	0.62	0.75	100KHz /0.25V
CR4010-150M	15	20	430	0.54	0.60	100KHz /0.25V
CR4010-220M	22	20	570	0.45	0.50	100KHz /0.25V

## Wound Ferrite SMD Inductor for Power Circuit-----CR Series

Operating Temp. : -40°C~125°C(including self-heating)

Part Number	Inductance (uH)	Tolerance (±%)	DCR(mΩ) ±25%	Isat (A)	Irise(A)	Test Condition
CR4012-R82N	0.82	30	50	3.02	1.65	100KHz /0.25V
CR4012-1R0N	1.0	30	50	2.61	1.65	100KHz /0.25V
CR4012-1R5N	1.5	30	65	2.10	1.46	100KHz /0.25V
CR4012-1R8N	1.8	30	80	2.12	1.32	100KHz /0.25V
CR4012-2R2N	2.2	30	85	1.90	1.32	100KHz /0.25V
CR4012-2R7N	2.7	30	90	1.76	1.25	100KHz /0.25V
CR4012-3R3N	3.3	30	110	1.72	1.12	100KHz /0.25V
CR4012-3R6N	3.6	30	110	1.20	1.12	100KHz /0.25V
CR4012-4R3N	4.3	30	140	1.58	1.00	100KHz /0.25V
CR4012-4R7N	4.7	30	125	1.15	1.05	100KHz /0.25V
CR4012-5R1N	5.1	30	155	1.55	0.95	100KHz /0.25V
CR4012-5R6N	5.6	30	140	1.00	1.00	100KHz /0.25V
CR4012-6R8M	6.8	20	198	0.85	0.84	100KHz /0.25V
CR4012-100M	10	20	265	0.80	0.77	100KHz /0.25V
CR4012-120M	12	20	290	0.66	0.70	100KHz /0.25V
CR4012-150M	15	20	340	0.56	0.64	100KHz /0.25V
CR4012-180M	18	20	470	0.55	0.55	100KHz /0.25V
CR4012-220M	22	20	587	0.46	0.49	100KHz /0.25V
CR4015-1R5N	1.5	30	40	2.70	2.20	100KHz /0.25V
CR4015-2R2M	2.2	20	53	2.10	2.00	100KHz /0.25V
CR4015-3R3M	3.3	20	75	1.90	1.80	100KHz /0.25V
CR4015-4R7M	4.7	20	100	1.45	1.35	100KHz /0.25V
CR4015-6R8M	6.8	20	135	1.30	1.20	100KHz /0.25V
CR4015-100M	10	20	200	1.10	1.00	100KHz /0.25V
CR4015-150M	15	20	300	0.90	0.85	100KHz /0.25V
CR4015-220M	22	20	400	0.72	0.68	100KHz /0.25V
CR4018-1R0N	1.0	30	23	4.5	2.50	100KHz /0.25V
CR4018-1R5N	1.5	30	33	3.35	2.34	100KHz /0.25V
CR4018-2R2M	2.2	20	44	2.70	2.00	100KHz /0.25V
CR4018-3R3M	3.3	20	70	2.45	1.90	100KHz /0.25V
CR4018-4R7M	4.7	20	90	1.70	1.70	100KHz /0.25V
CR4018-5R6M	5.6	20	103	1.60	1.50	100KHz /0.25V
CR4018-6R8M	6.8	20	124	1.45	1.30	100KHz /0.25V
CR4018-100M	10	20	200	1.30	1.10	100KHz /0.25V
CR4018-150M	15	20	268	0.94	0.92	100KHz /0.25V
CR4018-220M	22	20	390	0.80	0.80	100KHz /0.25V
CR4018-330M	33	20	560	0.65	0.60	100KHz /0.25V
CR4018-470M	47	20	756	0.57	0.50	100KHz /0.25V

#### Isat (A):

The saturation current value (Isat) is the DC current value having inductance decrease down to 30%(at 20°C).

#### Irise(A)

The temperature rise current value (Irise) is the DC current having temperature increase up to 40°C(at 20°C)

#### Remarks:

With the series of other highly products have been improved

同系列其他高度的产品已在完善中



## Wound Ferrite SMD Inductor for Power Circuit-----CR Series

Operating Temp. : -40°C~125°C(including self-heating )

Part Number	Inductance (uH)	Tolerance (±%)	DCR(mΩ) ±25%	Isat (A)	Irise(A)	Test Condition
CR4020-1R0N	1.0	30	29	5.10	2.15	100KHz /0.25V
CR4020-1R2N	1.2	30	29	4.78	2.15	100KHz /0.25V
CR4020-1R5N	1.5	30	35	4.45	1.98	100KHz /0.25V
CR4020-2R2N	2.2	30	40	3.20	1.85	100KHz /0.25V
CR4020-3R3M	3.3	20	70	3.10	1.40	100KHz /0.25V
CR4020-3R6M	3.6	20	55	2.80	1.54	100KHz /0.25V
CR4020-4R7M	4.7	20	75	2.35	1.34	100KHz /0.25V
CR4020-5R1M	5.1	20	85	2.30	1.27	100KHz /0.25V
CR4020-5R6M	5.6	20	90	2.20	1.22	100KHz /0.25V
CR4020-6R2M	6.2	20	115	2.15	1.08	100KHz /0.25V
CR4020-6R8M	6.8	20	125	2.20	1.04	100KHz /0.25V
CR4020-7R5M	7.5	20	115	1.85	1.08	100KHz /0.25V
CR4020-8R2M	8.2	20	125	1.75	1.04	100KHz /0.25V
CR4020-100M	10	20	165	1.60	0.90	100KHz /0.25V
CR4020-120M	12	20	175	1.50	0.88	100KHz /0.25V
CR4020-150M	15	20	230	1.35	0.77	100KHz /0.25V
CR4020-220M	22	20	350	1.05	0.62	100KHz /0.25V
CR4030-R91N	0.91	30	13	6.25	4.00	100KHz /0.25V
CR4030-1R2N	1.2	30	15	5.80	3.82	100KHz /0.25V
CR4030-1R5N	1.5	30	20	4.84	3.34	100KHz /0.25V
CR4030-1R8N	1.8	30	28	4.80	3.00	100KHz /0.25V
CR4030-2R2N	2.2	30	35	4.10	2.95	100KHz /0.25V
CR4030-3R3M	3.3	20	40	3.30	2.40	100KHz /0.25V
CR4030-4R3M	4.3	20	55	2.95	2.10	100KHz /0.25V
CR4030-4R7M	4.7	20	60	2.90	2.00	100KHz /0.25V
CR4030-5R6M	5.6	20	65	2.60	1.95	100KHz /0.25V
CR4030-6R8M	6.8	20	90	2.75	1.60	100KHz /0.25V
CR4030-7R5M	7.5	20	85	2.20	1.65	100KHz /0.25V
CR4030-8R2M	8.2	20	90	2.10	1.60	100KHz /0.25V
CR4030-100M	10	20	100	1.95	1.50	100KHz /0.25V
CR4030-120M	12	20	135	1.70	1.30	100KHz /0.25V
CR4030-150M	15	20	190	1.65	1.11	100KHz /0.25V
CR4030-180M	18	20	200	1.40	1.10	100KHz /0.25V
CR4030-220M	22	20	225	1.30	1.00	100KHz /0.25V
CR4030-330M	33	20	330	1.10	0.84	100KHz /0.25V
CR4030-360M	36	20	335	1.05	0.83	100KHz /0.25V
CR4030-390M	39	20	435	1.03	0.73	100KHz /0.25V
CR4030-470M	47	20	445	0.95	0.72	100KHz /0.25V

### Isat (A):

The saturation current value (Isat) is the DC current value having inductance decrease down to 30%(at 20°C)。

### Irise(A)

The temperature rise current value (Irise) is the DC current having temperature increase up to 40°C(at 20°C)

### Remarks:

With the series of other highly products have been improved

同系列其他高度的产品已在完善中

## Wound Ferrite SMD Inductor for Power Circuit-----CR Series

Operating Temp. : -40°C~125°C(including self-heating )



### ※CR5 Series

Shape and Dimension (Unit:mm)

Recommended Land Pattern

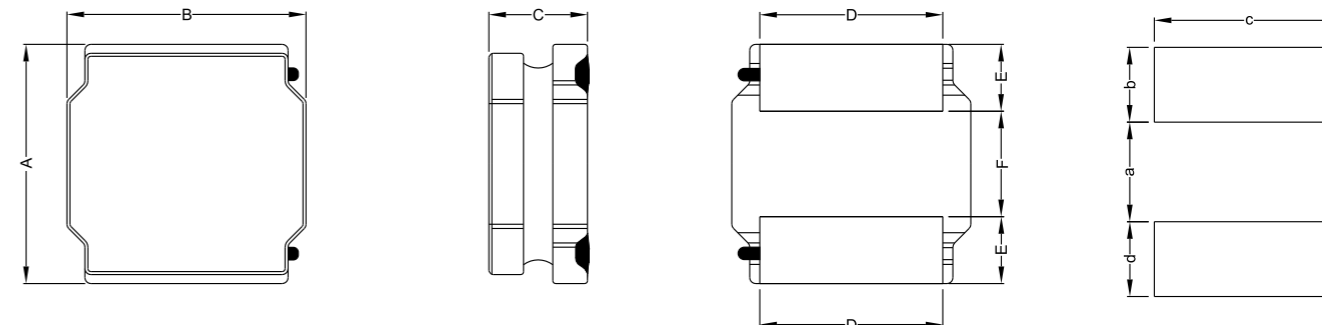

Series	A	B	C Max	D	E	F	a Typ.	b Typ.	c Typ.
CR5015	5.0±0.2	5.0±0.2	1.5	4.0±0.2	1.25±0.2	2.5±0.2	4.2	2.3	1.4
CR5020	5.0±0.2	5.0±0.2	2.0	4.0±0.2	1.25±0.2	2.5±0.2	4.2	2.3	1.4
CR5030	5.0±0.2	5.0±0.2	3.0	4.0±0.2	1.25±0.2	2.5±0.2	4.2	2.3	1.4
CR5040	5.0±0.2	5.0±0.2	4.0	4.0±0.2	1.25±0.2	2.5±0.2	4.2	2.3	1.4

### Electronic Characteristics List

Part Number	Inductance (uH)	Tolerance (±%)	DCR(mΩ) ±25%	Isat (A)	Irise(A)	Test Condition
CR5015-1R0N	1.0	30	35	4.50	2.80	100KHz /0.25V
CR5015-1R5N	1.5	30	50	3.50	2.50	100KHz /0.25V
CR5015-2R2N	2.2	30	65	3.00	2.20	100KHz /0.25V
CR5015-3R3N	3.3	30	80	2.50	1.90	100KHz /0.25V
CR5015-4R7N	4.7	30	100	2.10	1.60	100KHz /0.25V
CR5015-6R8M	6.8	20	150	1.65	1.40	100KHz /0.25V
CR5015-100M	10	20	200	1.45	1.20	100KHz /0.25V
CR5020-1R0N	1.0	30	20	4.33	3.70	100KHz /0.25V
CR5020-1R5N	1.5	30	26	4.10	3.20	100KHz /0.25V
CR5020-2R2N	2.2	30	38	3.85	2.90	100KHz /0.25V
CR5020-3R3N	3.3	30	46	3.25	2.40	100KHz /0.25V
CR5020-4R7M	4.7	20	65	2.40	2.05	100KHz /0.25V
CR5020-6R8M	6.8	20	92	2.10	1.70	100KHz /0.25V
CR5020-100M	10	20	125	1.80	1.50	100KHz /0.25V
CR5020-150M	15	20	180	1.44	1.25	100KHz /0.25V
CR5020-220M	22	20	250	1.18	1.05	100KHz /0.25V
CR5020-330M	33	20	370	0.97	0.83	100KHz /0.25V
CR5020-470M	47	20	560	0.81	0.70	100KHz /0.25V

### Isat (A):

The saturation current value (Isat) is the DC current value having inductance decrease down to 30%(at 20°C)。

### Irise(A)

The temperature rise current value (Irise) is the DC current having temperature increase up to 40°C(at 20°C)

### Remarks:

With the series of other highly products have been improved

同系列其他高度的产品已在完善中

## Wound Ferrite SMD Inductor for Power Circuit-----CR Series

Operating Temp. : -40°C~125°C(including self-heating )

Part Number	Inductance (uH)	Tolerance (±%)	DCR(mΩ) ±25%	Isat (A)	Irise(A)	Test Condition
CR5040-1R0N	1.0	30	12	7.35	4.90	100KHz /0.25V
CR5040-1R5N	1.5	30	15	6.30	4.30	100KHz /0.25V
CR5040-2R2N	2.2	30	19	4.90	3.80	100KHz /0.25V
CR5040-2R7N	2.7	30	22	4.30	3.60	100KHz /0.25V
CR5040-3R3N	3.3	30	24	3.95	3.40	100KHz /0.25V
CR5040-3R9N	3.9	30	27	3.55	3.20	100KHz /0.25V
CR5040-4R7N	4.7	30	30	3.50	3.00	100KHz /0.25V
CR5040-6R8M	6.8	20	43	2.90	2.50	100KHz /0.25V
CR5040-100M	10	20	64	2.35	2.10	100KHz /0.25V
CR5040-150M	15	20	86	2.00	2.00	100KHz /0.25V
CR5040-220M	22	20	129	1.60	1.50	100KHz /0.25V
CR5040-330M	33	20	188	1.30	1.20	100KHz /0.25V
CR5040-470M	47	20	272	1.10	1.00	100KHz /0.25V
CR5040-680M	68	20	400	0.90	0.80	100KHz /0.25V
CR5040-101M	100	20	560	0.75	0.70	100KHz /0.25V

### Isat (A):

The saturation current value (Isat) is the DC current value having inductance decrease down to 30%(at 20°C)。

### Irise(A)

The temperature rise current value (Irise) is the DC current having temperature increase up to 40°C(at 20°C)

### Remarks:

With the series of other highly products have been improved

同系列其他高度的产品已在完善中

## Wound Ferrite SMD Inductor for Power Circuit-----CR Series

Operating Temp. : -40°C~125°C(including self-heating )

### ※CR6 Series

Shape and Dimension (Unit:mm)

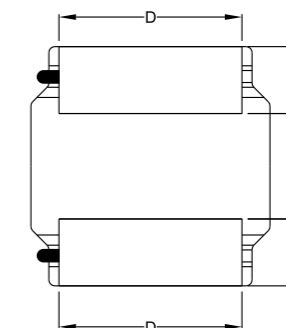
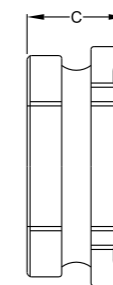
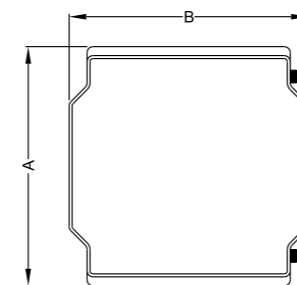

Recommended Land Pattern

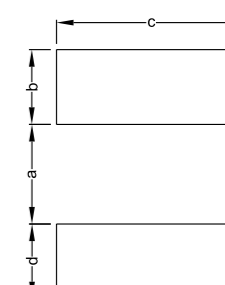

Series	A	B	C Max	D	E	F	a Typ.	b Typ.	c Typ.
CR6010	6.0±0.3	6.0±0.3	1.0	4.9±0.3	1.55±0.3	2.9±0.3	1.7	2.8	5.7
CR6012	6.0±0.3	6.0±0.3	1.2	4.9±0.3	1.55±0.3	2.9±0.3	1.7	2.8	5.7
CR6015	6.0±0.3	6.0±0.3	1.5	4.9±0.3	1.55±0.3	2.9±0.3	1.7	2.8	5.7
CR6020	6.0±0.3	6.0±0.3	2.0	4.9±0.3	1.55±0.3	2.9±0.3	1.7	2.8	5.7
CR6028	6.0±0.3	6.0±0.3	2.8	4.9±0.3	1.55±0.3	2.9±0.3	1.7	2.8	5.7
CR6045	6.0±0.3	6.0±0.3	4.5	4.9±0.3	1.55±0.3	2.9±0.3	1.7	2.8	5.7

### Electronic Characteristics List

Part Number	Inductance (uH)	Tolerance (±%)	DCR(mΩ) ±25%	Isat (A)	Irise(A)	Test Condition
CR6015-1R2N	1.2	30	35	4.20	2.80	100KHz /0.25V
CR6015-2R2N	2.2	30	50	3.10	2.30	100KHz /0.25V
CR6015-3R3N	3.3	30	60	2.60	2.10	100KHz /0.25V
CR6015-4R7M	4.7	20	90	2.10	1.90	100KHz /0.25V
CR6015-6R8M	6.8	20	115	1.80	1.65	100KHz /0.25V
CR6015-100M	10	20	155	1.45	1.35	100KHz /0.25V
CR6015-150M	15	20	220	1.20	1.20	100KHz /0.25V
CR6015-220M	22	20	320	1.00	1.00	100KHz /0.25V
CR6020-1R0N	1.0	30	20	4.30	3.50	100KHz /0.25V
CR6020-1R5N	1.5	30	25	4.25	3.20	100KHz /0.25V
CR6020-2R2N	2.2	30	35	3.75	2.75	100KHz /0.25V
CR6020-3R3N	3.3	30	45	3.15	2.60	100KHz /0.25V
CR6020-4R7N	4.7	30	58	3.00	2.00	100KHz /0.25V
CR6020-5R6M	5.6	20	70	2.40	1.90	100KHz /0.25V
CR6020-6R8M	6.8	20	85	2.20	1.80	100KHz /0.25V
CR6020-100M	10	20	120	1.75	1.40	100KHz /0.25V
CR6020-150M	15	20	160	1.50	1.20	100KHz /0.25V
CR6020-220M	22	20	240	1.25	1.00	100KHz /0.25V
CR6020-470M	47	20	500	1.00	0.80	100KHz /0.25V

### Isat (A):

The saturation current value (Isat) is the DC current value having inductance decrease down to 30%(at 20°C)。

### Irise(A)

The temperature rise current value (Irise) is the DC current having temperature increase up to 40°C(at 20°C)

### Remarks:

With the series of other highly products have been improved

同系列其他高度的产品已在完善中

## Wound Ferrite SMD Inductor for Power Circuit-----CR Series

Operating Temp. : -40°C~125°C(including self-heating )

Part Number	Inductance (uH)	Tolerance (±%)	DCR(mΩ) ±25%	Isat (A)	Irise(A)	Test Condition
CR6028-1R0N	1.0	30	10	5.75	5.20	100KHz /0.25V
CR6028-1R5N	1.5	30	13	6.00	4.58	100KHz /0.25V
CR6028-2R2N	2.2	30	20	5.10	3.75	100KHz /0.25V
CR6028-2R7N	2.7	30	20	3.80	3.75	100KHz /0.25V
CR6028-3R3N	3.3	30	25	4.15	3.48	100KHz /0.25V
CR6028-4R7N	4.7	30	30	3.00	3.08	100KHz /0.25V
CR6028-5R1N	5.1	30	43	3.20	2.60	100KHz /0.25V
CR6028-6R2M	6.2	20	47	3.05	2.40	100KHz /0.25V
CR6028-6R8M	6.8	20	47	2.60	2.40	100KHz /0.25V
CR6028-8R2M	8.2	20	55	2.30	2.25	100KHz /0.25V
CR6028-9R1M	9.1	20	74	2.55	2.15	100KHz /0.25V
CR6028-100M	10	20	72	2.04	1.95	100KHz /0.25V
CR6028-120M	12	20	80	1.80	1.85	100KHz /0.25V
CR6028-150M	15	20	125	1.75	1.45	100KHz /0.25V
CR6028-180M	18	20	120	1.52	1.45	100KHz /0.25V
CR6028-220M	22	20	140	1.45	1.40	100KHz /0.25V
CR6028-270M	27	20	155	1.50	1.32	100KHz /0.25V
CR6028-330M	33	20	185	1.35	1.22	100KHz /0.25V
CR6028-360M	36	20	215	1.25	1.13	100KHz /0.25V
CR6045-1R0N	1.0	30	10	9.0	5.1	100KHz /0.25V
CR6045-2R2N	2.2	30	13	6.5	4.6	100KHz /0.25V
CR6045-3R3N	3.3	30	20	5.3	3.2	100KHz /0.25V
CR6045-4R7N	4.7	30	24	4.5	3.0	100KHz /0.25V
CR6045-5R6N	5.6	30	31	3.7	2.8	100KHz /0.25V
CR6045-6R8M	6.8	20	33	3.3	2.7	100KHz /0.25V
CR6045-100M	10	20	52	3.0	2.5	100KHz /0.25V
CR6045-150M	15	20	77	2.5	1.9	100KHz /0.25V
CR6045-220M	22	20	115	2.0	1.5	100KHz /0.25V
CR6045-330M	33	20	150	1.6	1.45	100KHz /0.25V
CR6045-470M	47	20	220	1.4	1.20	100KHz /0.25V
CR6045-560M	56	20	260	1.3	1.10	100KHz /0.25V
CR6045-680M	68	20	290	1.2	0.9	100KHz /0.25V
CR6045-101M	100	20	430	1.0	0.8	100KHz /0.25V

### Isat (A):

The saturation current value (Isat) is the DC current value having inductance decrease down to 30%(at 20°C)。

### Irise(A)

The temperature rise current value (Irise) is the DC current having temperature increase up to 40°C(at 20°C)

### Remarks:

With the series of other highly products have been improved

同系列其他高度的产品已在完善中

## Wound Ferrite SMD Inductor for Power Circuit-----CR Series

Operating Temp. : -40°C~125°C(including self-heating )

### ※CR8 Series

Shape and Dimension (Unit:mm)

Recommended Land Pattern

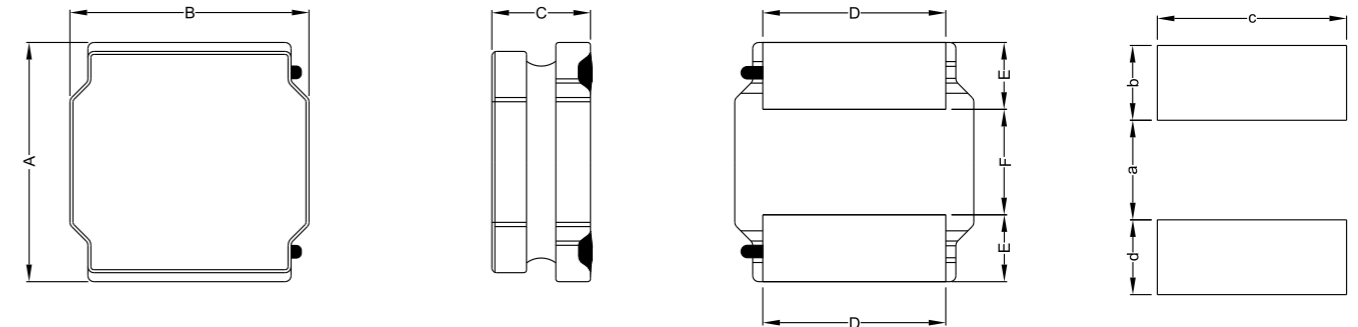

Series	A	B	C	D	E	F	a Typ.	b Typ.	c Typ.
CR8040	8.0 ± 0.3	8.0 ± 0.3	4.2Max	6.3±0.3	2.2±0.3	4.0±0.3	2.2	3.8	7.5

### Electronic Characteristics List

Part Number	Inductance (uH)	Tolerance (±%)	DCR(mΩ) ±25%	Isat (A)	Irise(A)	Test Condition
CR8040-1R0N	1.0	30	8	9.85	6.30	100KHz /0.25V
CR8040-1R5N	1.0	30	10	8.15	5.65	100KHz /0.25V
CR8040-2R2N	2.2	30	12	7.10	5.15	100KHz /0.25V
CR8040-3R3N	3.3	30	17	6.50	4.40	100KHz /0.25V
CR8040-4R7N	4.7	30	20	5.90	4.00	100KHz /0.25V
CR8040-5R6N	5.6	30	24	5.50	3.80	100KHz /0.25V
CR8040-6R8M	6.8	20	28	4.55	3.60	100KHz /0.25V
CR8040-8R2M	8.2	20	35	4.20	3.40	100KHz /0.25V
CR8040-100M	10	20	37	3.60	3.10	100KHz /0.25V
CR8040-150M	15	20	56	2.95	2.50	100KHz /0.25V
CR8040-220M	22	20	74	2.40	2.00	100KHz /0.25V
CR8040-330M	33	20	100	2.05	1.70	100KHz /0.25V
CR8040-470M	47	20	158	1.75	1.50	100KHz /0.25V
CR8040-680M	68	20	196	1.45	1.20	100KHz /0.25V
CR8040-101M	100	20	295	1.15	1.00	100KHz /0.25V
CR8040-151M	150	20	470	1.10	0.80	100KHz /0.25V
CR8040-221M	220	20	660	0.85	0.70	100KHz /0.25V
CR8040-331M	330	20	970	0.68	0.55	100KHz /0.25V

### Isat (A):

The saturation current value (Isat) is the DC current value having inductance decrease down to 30%(at 20°C)。

### Irise(A)

The temperature rise current value (Irise) is the DC current having temperature increase up to 40°C(at 20°C)

### Remarks:

With the series of other highly products have been improved

同系列其他高度的产品已在完善中

## Molding Power Choke-----SHI Series

Operating Temp. : -40°C~125°C(including self-heating)



### Feature

- Shielded construction
- Handles high transient current spikes without saturation
- Ultra low buzz noise, due to composite construction
- 100% Pb lead(Pb) free meet RoHS standard

### Application

- PAD/Notebook/Desktop/sever application
- Low profile, high current power supplies
- Battery powered devices
- DC/DC converter for Filed Programmable Gate Array (FPGA)

### Production identification

SHI 0603 1R0 M

① ② ③ ④

SHI ①
Product Name

1R0 ③
Inductance Value
1R0 :1.0uH

② External Dimensions {L x W x H[max.]} [Unit: mm]	
0402	4.1 x 4.5 x 2.0
0515	5.4 x 5.75 x 1.8
0603	6.6 x 7.1 x 3.0

M ④
Tolerance
M : ± 20%
N : ± 30%

### ※SHI Series

Shape and Dimension (Unit:mm)

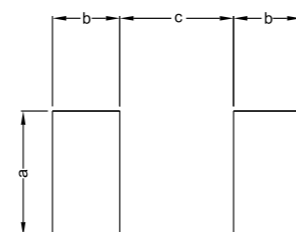
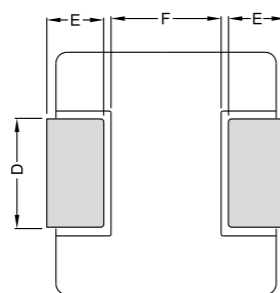
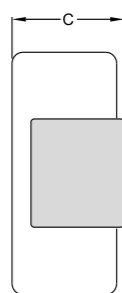
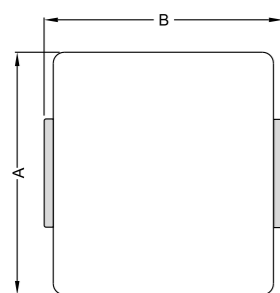

Recommended Land Pattern

Series	A	B	C	D	E	F	a Typ.	b Typ.	c Typ.
SHI0402	4.1 ± 0.2	4.5 ± 0.2	2.0Max	1.5Ref	0.8Ref	2.2Ref	2.5Ref	1.5Ref	2.3Ref
SHI0515	5.4 ± 0.2	5.7 ± 0.2	1.8Max	2.0Ref	1.2Ref	2.4Ref	2.5Ref	1.5Ref	2.2Ref
SHI0603	6.6 ± 0.2	7.1 ± 0.2	3.0Max	3.0Ref	1.8Ref	3.5Ref	3.5Ref	2.45Ref	3.5Ref

## Molding Power Choke-----SHI Series

Operating Temp. : -40°C~125°C(including self-heating)

### Electronic Characteristics List

P/N	L0 Inductance uH±20% @0A	DCR		Heat Rating Current	Saturation Current
		Typical	Max	Idc(Amp) Typical※ 1	Isat(Amp) Typical※2
SHI0402-R15M	0.15	5.0	5.5	10.0	15.0
SHI0402-R22M	0.22	6.0	6.6	9.0	12.5
SHI0402-R33M	0.33	11.0	12.0	8.0	11.0
SHI0402-R47M	0.47	12.0	14.0	7.0	9.5
SHI0402-R68M	0.68	19.5	21.0	5.0	8.0
SHI0402-1R0M	1.0	25.0	27.0	4.5	7.0
SHI0402-1R5M	1.5	42.0	46.0	4.0	6.0
SHI0402-2R2M	2.2	52.0	58.0	3.0	5.0
SHI0402-3R3M	3.3	78.0	87.0	2.5	4.0
SHI0402-4R7M	4.7	105.0	115.0	2.4	3.0
SHI0515-1R0M	1.0	20.0	23.0	6.5	9.0
SHI0515-1R2M	1.2	29.3	33.7	5.3	8.0
SHI0515-2R2M	2.2	58.0	64.0	3.3	6.0
SHI0515-3R3M	3.3	65.0	72.0	3.2	5.0
SHI0515-4R7M	4.7	95.0	106.0	3.0	4.0
SHI0515-6R8M	6.8	120.0	130.0	2.5	3.2
SHI0515-100M	10.0	153.0	170.0	2.0	3.0
SHI0515-150M	15.0	310.0	350.0	1.3	2.3
SHI0603-R15M	0.15	1.9	2.5	22.5	42.0
SHI0603-R20M	0.20	2.4	3.0	19.5	41.0
SHI0603-R22M	0.22	2.5	3.5	19.0	40.0
SHI0603-R33M	0.33	3.5	3.9	17.0	30.0
SHI0603-R47M	0.47	4.0	4.5	14.0	20.0
SHI0603-R68M	0.68	5.5	6.5	15.5	25.0
SHI0603-R82M	0.82	6.7	8.0	13.0	24.0
SHI0603-1R0M	1.0	9.0	10.0	11.0	22.0
SHI0603-1R5M	1.5	13.0	15.0	9.0	18.0
SHI0603-2R2M	2.2	16.0	20.0	8.0	14.0
SHI0603-3R3M	3.3	28.0	30.0	6.0	13.5
SHI0603-4R7M	4.7	37.0	40.0	5.5	10.0
SHI0603-6R8M	6.8	54.0	60.0	4.5	8.0
SHI0603-8R2M	8.2	64.0	68.0	4.0	7.5
SHI0603-100M	10.0	84.0	105.0	3.0	7.0

Isat (A): ※ 1

The saturation current value (Isat) is the DC current value having inductance decrease down to 25%(at 20°C).

Irise (A): ※ 2

The temperature rise current value (Irise) is the DC current having temperature increase up to 40°C(at 20°C).

## Wound Ferrite SMD Inductor for Power Circuit-----CD Series

Operating Temp. : -40°C~125°C(including self-heating)



### Feature

- Ferrite drum core construction.
- Magnetically unshielded.
- Moisture Sensitivity Level: 1
- RoHS compliance.
- Halogen Free available.

### Application

- Ideally used in Mobilephone,PDA,MP3,DSC/DVC, portable DVD etc as DC-DC Converter inductors.

### Production identification

CD 43 6R8 M T

① ② ③ ④ ⑤

① CD
Series Name

③ Inductance value
6R8 -----> 6.8uH
100----->10uH

④ Inductance Tolerance
K-----> ± 10%
M-----> ± 20%
N-----> ± 30%

② External Dimensions (L × W × H.) [Unit: mm]	
CD32	3.0 × 3.5 × 2.4
CD43	4.0 × 4.5 × 3.5
CD54	5.2 × 5.8 × 4.8
CD75	7.0 × 7.8 × 5.2

⑤ Packing Type
T---->Tape Carrier Package

### ※CD Series

Shape and Dimension (Unit:mm)

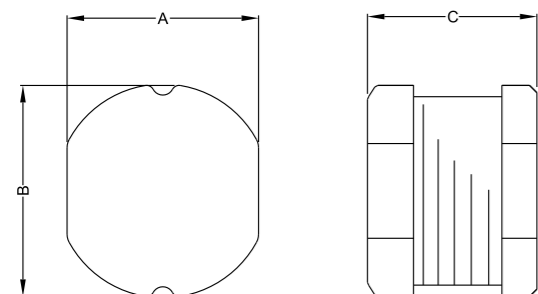

Recommended Land Pattern

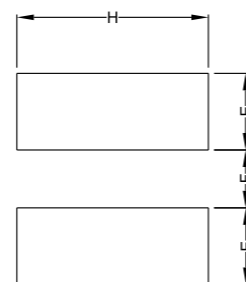

Series	A	B	C	D	E Typ.	F Typ.	H Typ.
CD32	3.0±0.3	3.5±0.3	2.4Max	1.0Ref	1.3Ref	0.9Ref	3.5Ref
CD43	4.0±0.3	4.5±0.3	3.5Max	1.5Ref	1.8Ref	1.2Ref	4.5Ref
CD54	5.2±0.3	5.8±0.3	4.8Max	1.5Ref	2.6Ref	1.0Ref	5.8Ref
CD75	7.0±0.3	7.8±0.3	5.2Max	2.5Ref	3.0Ref	2.0Ref	7.5Ref
CD105	9.0±0.3	10.0±0.3	5.9Max	3.0Ref	3.75Ref	2.5Ref	9.5Ref

## Wound Ferrite SMD Inductor for Power Circuit-----CD Series

Operating Temp. : -40°C~125°C(including self-heating)

### Electronic Characteristics List

Part Name	Stamp	Inductance (μH) [Within]	D.C.R. (mΩ) [Max.] ( 20°C)	Rated Current (A)
CD43-1R0M	1R0	1.0	23.0m	2.60
CD43-1R5M	1R5	1.5	28.0m	2.50
CD43-2R2M	2R2	2.2	42.0m	2.30
CD43-3R3M	3R3	3.3	51.0m	2.10
CD43-3R9M	3R9	3.9	60.0m	1.90
CD43-4R7M	4R7	4.7	76.0m	1.60
CD43-5R6M	5R6	5.6	83.0m	1.45
CD43-6R8M	6R8	6.8	100.0m	1.35
CD43-8R2M	8R2	8.2	120.0m	1.30
CD43-100K	100	10	150.0m	1.00
CD43-120K	120	12	155.0m	0.90
CD43-150K	150	15	195.0m	0.80
CD43-180K	180	18	230.0m	0.70
CD43-220K	220	22	270.0m	0.60
CD43-270K	270	27	310.0m	0.55
CD43-330K	330	33	345.0m	0.50
CD43-390K	390	39	400.0m	0.48
CD43-470K	470	47	525.0m	0.40
CD43-560K	560	56	595.0m	0.38
CD43-680K	680	68	740.0m	0.33
CD43-820K	820	82	880.0m	0.29
CD43-101K	101	100	1.20	0.26
CD43-121K	121	120	1.25	0.24
CD43-151K	151	150	1.60	0.22
CD43-181K	181	180	2.00	0.19
CD43-221K	221	220	2.35	0.18
CD43-271K	271	270	3.25	0.16
CD43-331K	331	330	3.55	0.15
CD43-391K	391	390	4.20	0.13
CD43-471K	471	470	4.90	0.12
CD43-561K	561	560	6.50	0.10
CD43-681K	681	680	8.30	0.09

1. Inductance tolerance: M: ± 20%; K ± 10%

2. Inductance measuring frequency: L ≤ 10uH at 100KHz/0.25V  
L > 10uH at 1KHz/0.25v

3. Rated current: The DC current at which the inductance decreases to 90% of it's initial value or when Δt=40°C, whichever is lower(Ta=20°C).

## Wound Ferrite SMD Inductor for Power Circuit-----CD Series

Operating Temp. : -40°C~125°C(including self-heating )

### Electronic Characteristics List

Part Name	Stamp	Inductance ( $\mu$ H) [Within]	D.C.R. (m $\Omega$ ) [Max.] ( 20°C)	Rated Current (A)
CD54-1R0M	1R0	1.0	13.0m	5.4
CD54-1R5M	1R5	1.5	16.9m	4.7
CD54-1R8M	1R8	1.8	19.5m	4.5
CD54-2R2M	2R2	2.2	22.1m	4.0
CD54-3R3M	3R3	3.3	31.2m	3.7
CD54-3R9M	3R9	3.9	36.4m	3.2
CD54-4R7M	4R7	4.7	52.0m	3.1
CD54-5R6M	5R6	5.6	54.6m	2.8
CD54-6R8M	6R8	6.8	60.0m	2.4
CD54-8R2M	8R2	8.2	65.0m	2.0
CD54-100K	100	10	76.0m	1.42
CD54-120K	120	12	85.0m	1.38
CD54-150K	150	15	105.0m	1.28
CD54-180K	180	18	125.0m	1.22
CD54-220K	220	22	150.0m	1.10
CD54-270K	270	27	188.0m	0.95
CD54-330K	330	33	215.0m	0.86
CD54-390K	390	39	263.0m	0.78
CD54-470K	470	47	355.0m	0.71
CD54-560K	560	56	377.0m	0.66
CD54-680K	680	68	390.0m	0.60
CD54-820K	820	82	416.0m	0.57
CD54-101K	101	100	611.0m	0.51
CD54-121K	121	120	754.0m	0.47
CD54-151K	151	150	845.0m	0.38
CD54-181K	181	180	1.04	0.36
CD54-221K	221	220	1.45	0.34
CD54-271K	271	270	1.51	0.31
CD54-331K	331	330	1.76	0.28
CD54-391K	391	390	2.08	0.26
CD54-471K	471	470	2.99	0.24
CD54-561K	561	560	3.12	0.22
CD54-681K	681	680	3.90	0.20
CD54-821K	821	820	5.20	0.19

1. Inductance tolerance: M:  $\pm$ 20%; K  $\pm$ 10%

2. Inductance measuring frequency: L $\leq$ 10 $\mu$ H at 100KHz/0.25V  
L>10 $\mu$ H at 1KHz/0.25v

3. Rated current:The DC current at which the inductance decreases to 90% of it's initial value or when  $\Delta$ t=40°C, whichever is lower(Ta=20°C).

## Wound Ferrite SMD Inductor for Power Circuit-----CD Series

Operating Temp. : -40°C~125°C(including self-heating )

### Electronic Characteristics List

Part Name	Stamp	Inductance ( $\mu$ H) [Within]	D.C.R. (m $\Omega$ ) [Max.] ( 20°C)	Rated Current (A)
CD75-1R0N	1R0	1.0	13.00m	5.20
CD75-2R2M	2R2	2.2	14.00m	5.00
CD75-2R7M	2R7	2.7	16.90m	4.60
CD75-3R3M	3R3	3.3	19.50m	4.00
CD75-3R9M	3R9	3.9	23.40m	4.00
CD75-4R7M	4R7	4.7	26.00m	3.80
CD75-5R6M	5R6	5.6	27.30m	3.10
CD75-6R8M	6R8	6.8	32.50m	2.80
CD75-8R2M	8R2	8.2	39.00m	2.52
CD75-100K	100	10	41.60m	2.31
CD75-120K	120	12	49.40m	2.00
CD75-150K	150	15	71.50m	1.81
CD75-180K	180	18	84.50m	1.59
CD75-220K	220	22	91.00m	1.50
CD75-270K	270	27	106.60m	1.28
CD75-330K	330	33	119.60m	1.20
CD75-390K	390	39	149.50m	1.08
CD75-470K	470	47	175.50m	1.05
CD75-560K	560	56	208.00m	930m
CD75-680K	680	68	234.00m	830m
CD75-820K	820	82	273.00m	780m
CD75-101K	101	100	325.00m	730m
CD75-121K	121	120	390.00m	650m
CD75-151K	151	150	520.00m	580m
CD75-181K	181	180	598.00m	510m
CD75-221K	221	220	793.00m	480m
CD75-271K	271	270	884.00m	400m
CD75-331K	331	330	1.13	390m
CD75-391K	391	390	1.30	350m
CD75-471K	471	470	1.68	330m
CD75-561K	561	560	1.90	300m
CD75-681K	681	680	2.47	270m
CD75-821K	821	820	2.86	250m

1. Inductance tolerance: M:  $\pm$ 20%; K  $\pm$ 10%

2. Inductance measuring frequency: L $\leq$ 10 $\mu$ H at 100KHz/0.25V  
L>10 $\mu$ H at 1KHz/0.25v

3. Rated current:The DC current at which the inductance decreases to 90% of it's initial value or when  $\Delta$ t=40°C, whichever is lower(Ta=20°C).

## Wound Ferrite SMD Inductor for Power Circuit-----CD Series

Operating Temp. : -40°C~125°C(including self-heating )

### Electronic Characteristics List

Part Name	Stamp	Inductance ( $\mu$ H) [Within]	D.C.R. ( $\Omega$ ) [Max.] ( 20°C)	Rated Current (A)
CD105-1R0M	1R0	1.0	8.45m	8.00
CD105-1R4M	1R4	1.4	13.78m	6.80
CD105-1R5M	1R5	1.5	13.78m	6.80
CD105-1R8M	1R8	1.8	15.60m	6.50
CD105-2R7M	2R7	2.7	17.81m	5.50
CD105-3R3M	3R3	3.3	19.50m	5.00
CD105-4R7M	4R7	4.7	22.10m	4.60
CD105-5R6M	5R6	5.6	23.79m	4.00
CD105-6R8M	6R8	6.8	26.00m	3.60
CD105-8R2M	8R2	8.2	31.20m	3.20
CD105-100K	100	10	34.45m	2.58
CD105-120K	120	12	40.30m	2.44
CD105-150K	150	15	45.50m	2.26
CD105-180K	180	18	48.49m	2.13
CD105-220K	220	22	70.20m	1.93
CD105-270K	270	27	84.11m	1.74
CD105-330K	330	33	92.30m	1.46
CD105-390K	390	39	124.80m	1.36
CD105-470K	470	47	135.20m	1.26
CD105-560K	560	56	158.60m	1.15
CD105-680K	680	68	200.20m	1.10
CD105-820K	820	82	230.10m	980m
CD105-101K	101	100	260.00m	950m
CD105-121K	121	120	351.00m	870m
CD105-151K	151	150	403.00m	740m
CD105-181K	181	180	494.00m	700m
CD105-221K	221	220	572.00m	650m
CD105-271K	271	270	728.00m	540m
CD105-331K	331	330	845.00m	500m
CD105-391K	391	390	1.04	460m
CD105-471K	471	470	1.18	400m
CD105-561K	561	560	1.42	300m
CD105-681K	681	680	1.99	280m
CD105-821K	821	820	2.03	240m

1. Inductance tolerance: M:  $\pm 20\%$ ; K  $\pm 10\%$

2. Inductance measuring frequency:  $L \leq 10\mu\text{H}$  at 100KHz/0.25V  
 $L > 10\mu\text{H}$  at 1KHz/0.25v

3. Rated current: The DC current at which the inductance decreases to 90% of it's initial value or when  $\Delta t = 40^\circ\text{C}$ , whichever is lower( $T_a = 20^\circ\text{C}$ ).

## Wound Ferrite SMD Inductor for Power Circuit-----CDH6B Series

Operating Temp. : -40°C~125°C(including self-heating )



### Feature

- Ferrite drum core construction.
- Magnetically shielded.
- Moisture Sensitivity Level: 1
- RoHS compliance.
- Halogen Free available.

### Application

- Ideally used in Notebook PC, LCD TV, DVD, Game machine, STB, Projector etc as DC-DC converter inductors.

### Production identification

CDH 6B38 6R8 M T

① ② ③ ④ ⑤

① CDH
Series Name

③ Inductance value
6R8 -----> 6.8uH
100-----> 10uH

④ Inductance Tolerance
K-----> $\pm 10\%$
M-----> $\pm 20\%$
N-----> $\pm 30\%$

② External Dimensions (L x W x H.) [Unit: mm]	
CDH6B28	7.0 x 7.0 x 3.0
CDH6B38	7.0 x 7.0 x 4.0

⑤ Packing Type
T----> Tape Carrier Package

### ※CDH6B Series

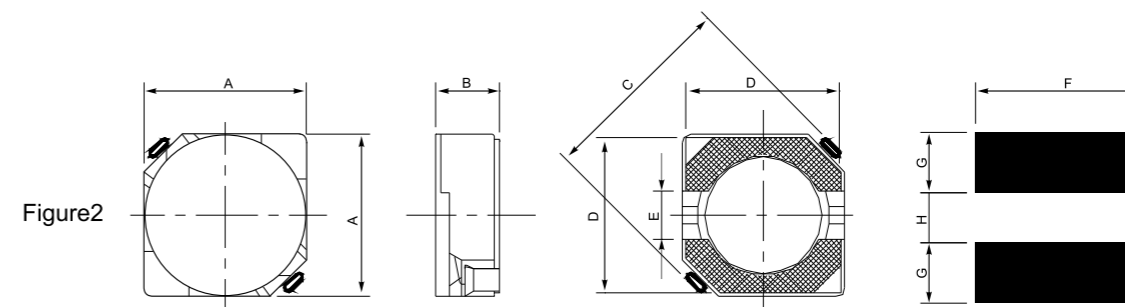

TYPE	A(max)	B ( max)	C(max)	D	E	F	G	H
CDH6B28	7.00	3.00	9.50	6.50	2.00	7.30	2.65	2.00
CDH6B38	7.00	4.00	9.50	6.50	2.00	7.30	2.65	2.00

## Wound Ferrite SMD Inductor for Power Circuit-----CDH6B Series

Operating Temp. : -40°C~125°C(including self-heating )

### Electronic Characteristics List

Part Name	L(H)	D.C.R( $\Omega$ ) : MAX.	Rated Current (A)※3
CDH6B28-1R0N	1.0u	18.2m	3.60
CDH6B28-1R8N	1.8u	20.8m	3.45
CDH6B28-2R2N	2.2u	24.7m	3.15
CDH6B28-2R7N	2.7u	27.3m	2.84
CDH6B28-3R3N	3.3u	29.9m	2.80
CDH6B28-3R9N	3.9u	32.5m	2.60
CDH6B28-4R7N	4.7u	40.3m	2.30
CDH6B28-5R6N	5.6u	45.5m	2.13
CDH6B28-6R8N	6.8u	46.8m	1.88
CDH6B28-8R2N	8.2u	55.9m	1.73
CDH6B28-100M	10u	75.4m	1.60
CDH6B28-120M	12u	80.6m	1.50
CDH6B28-150M	15u	89.7m	1.34
CDH6B28-180M	18u	93.6m	1.21
CDH6B28-220M	22u	122.2m	1.10
CDH6B28-270M	27u	131.3m	1.02
CDH6B28-330M	33u	159.9m	918m
CDH6B28-390M	39u	195m	835m
CDH6B28-470M	47u	234m	745m
CDH6B28-560M	56u	273m	685m
CDH6B28-680M	68u	364m	607m
CDH6B28-820M	82u	403m	570m
CDH6B28-101M	100u	507m	520m
CDH6B28-121M	120u	676m	450m
CDH6B28-151M	150u	806m	410m
CDH6B28-181M	180u	949m	380m
CDH6B28-221M	220u	1.11	350m
CDH6B28-271M	270u	1.56	310m
CDH6B28-331M	330u	1.70	285m
CDH6B28-391M	390u	1.95	253m
CDH6B28-471M	470u	2.73	230m
CDH6B28-561M	560u	2.99	220m
CDH6B28-681M	680u	3.51	193m

1. Inductance tolerance: M:  $\pm 20\%$ ; N:  $\pm 30\%$

2. Inductance measuring frequency:  $L \leq 10\mu\text{H}$  at 100KHz/0.25V  
 $L > 10\mu\text{H}$  at 1KHz/0.25V

3. Rated current: The DC current at which the inductance decreases to 65% of it's initial value or when  $\Delta t = 40^\circ\text{C}$ , whichever is lower ( $T_a = 20^\circ\text{C}$ ).

## Wound Ferrite SMD Inductor for Power Circuit-----CDH6B Series

Operating Temp. : -40°C~125°C(including self-heating )

### Electronic Characteristics List

Part Name	L(H)	D.C.R( $\Omega$ ) : MAX.	Rated Current (A)※3
CDH6B38-1R0	1.0u	19.5m	5.00
CDH6B38-1R8	1.8u	23.4m	3.90
CDH6B38-2R7	2.7u	28.6m	3.40
CDH6B38-3R3	3.3u	33.8m	2.95
CDH6B38-3R9	3.9u	36.4m	2.90
CDH6B38-4R7	4.7u	37.7m	2.88
CDH6B38-5R6	5.6u	41.6m	2.61
CDH6B38-6R8	6.8u	49.4m	2.39
CDH6B38-8R2	8.2u	54.6m	2.07
CDH6B38-100	10u	63.7m	2.00
CDH6B38-120	12u	78.0m	1.94
CDH6B38-150	15u	87.1m	1.60
CDH6B38-180	18u	106.6m	1.44
CDH6B38-220	22u	113.1m	1.30
CDH6B38-270	27u	130.0m	1.20
CDH6B38-330	33u	143.0m	1.07
CDH6B38-390	39u	163.8m	1.00
CDH6B38-470	47u	182m	950m
CDH6B38-560	56u	221m	850m
CDH6B38-680	68u	234m	750m
CDH6B38-750	75u	286m	720m
CDH6B38-820	82u	324m	700m
CDH6B38-101	100u	358m	630m
CDH6B38-121	120u	442m	605m
CDH6B38-151	150u	572m	513m
CDH6B38-181	180u	637m	486m
CDH6B38-221	220u	936m	427m
CDH6B38-271	270u	1.00	387m
CDH6B38-331	330u	1.20	350m
CDH6B38-391	390u	1.30	318m
CDH6B38-471	470u	1.95	294m
CDH6B38-561	560u	2.34	260m
CDH6B38-681	680u	2.47	230m

1. Inductance tolerance: M:  $\pm 20\%$ ; N:  $\pm 30\%$

2. Inductance measuring frequency:  $L \leq 10\mu\text{H}$  at 100KHz/0.25V  
 $L > 10\mu\text{H}$  at 1KHz/0.25V

3. Rated current: The DC current at which the inductance decreases to 65% of it's initial value or when  $\Delta t = 40^\circ\text{C}$ , whichever is lower ( $T_a = 20^\circ\text{C}$ ).



## Wound Ferrite SMD Inductor for Power Circuit-----CDH8B Series

Operating Temp. : -40°C~125°C(including self-heating)



### Feature

- Ferrite drum core construction
- Magnetically shielded
- Moisture Sensitivity Level: 1
- RoHS compliance
- Halogen Free available

### Application

- Ideally used in Mobile phone, MP3, PDA ,HDD,DSC/DVC, etc as DC-DC converter inductors

### Production identification

CDH 8B43 6R8 M T

① ② ③ ④ ⑤

① CDH
Series Name
③ Inductance value
6R8 -----> 6.8uH
100----->10uH
④ Inductance Tolerance
K-----> ± 10%
M-----> ± 20%
N-----> ± 30%

② External Dimensions (L × W × H.) [Unit: mm]	
CDH8B28B	8.3 × 8.3 × 3.0
CDH8B38B	8.3 × 8.3 × 4.0
CDH8B43B	8.3 × 8.3 × 4.5

⑤ Packing Type
T---->Tape Carrier Package

### ※CDH8B Series

Dimensions and Land Patterns  
(UNIT: mm)

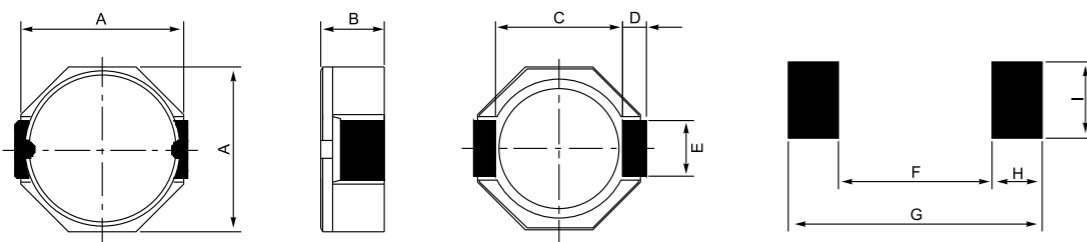

Series	A	B	C	D	E (Ref)	F (Ref)	G (Ref)	H (Ref)	I (Ref)
CDH8B28B	8.30	3.00	5.90	1.20	2.50	6.10	10.10	2.00	2.80
CDH8B38B	8.30	4.00	5.90	1.20	2.50	6.10	10.10	2.00	2.80
CDH8B43B	8.30	4.50	5.90	1.20	2.50	6.10	10.10	2.00	2.80

## Wound Ferrite SMD Inductor for Power Circuit-----CDH8B Series

Operating Temp. : -40°C~125°C(including self-heating)

### Electronic Characteristics List

Part Name	L(H)	D.C.R(Ω) : MAX.	Rated Current (A)※1
CDH8B28B-2R5N	2.5u	26.00m	4.13
CDH8B28B-3R3N	3.3u	32.50m	3.70
CDH8B28B-3R9N	3.9u	58.50m	3.00
CDH8B28B-4R7N	4.7u	62.00m	2.60
CDH8B28B-6R8N	6.8u	85.00m	2.50
CDH8B28B-100M	10u	91.00m	2.50
CDH8B28B-150M	15u	137.00m	1.61
CDH8B28B-220M	22u	195.00m	1.40
CDH8B28B-330M	33u	319.00m	1.16
CDH8B28B-470M	47u	423.00m	900m
CDH8B28B-680M	68u	559.00m	750m
CDH8B28B-101M	100u	793.00m	580m
CDH8B28B-121M	120u	935.00m	510m
CDH8B28B-151M	150u	1.09	470m
CDH8B28B-181M	180u	1.65	420m
CDH8B28B-221M	220u	1.82	400m
CDH8B28B-331M	330u	2.0	330m
CDH8B38B-2R2N	2.2u	20m	5.40
CDH8B38B-3R9N	3.9u	29m	4.30
CDH8B38B-6R8N	6.8u	36m	3.00
CDH8B38B-100M	10u	49m	2.70
CDH8B38B-150M	15u	75m	2.30
CDH8B38B-220M	22u	109m	1.88
CDH8B38B-330M	33u	163m	1.52
CDH8B38B-470M	47u	211m	1.28
CDH8B38B-680M	68u	304m	1.10
CDH8B38B-101M	100u	416m	880m
CDH8B38B-121M	120u	494m	830m
CDH8B38B-151M	150u	598m	780m
CDH8B38B-181M	180u	780m	700m
CDH8B38B-221M	220u	910m	636m
CDH8B38B-271M	270u	1.1	550m
CDH8B43B-1R8N	1.8u	16.00m	5.15
CDH8B43B-2R5N	2.5u	20.00m	5.00
CDH8B43B-3R3N	3.3u	22.00m	4.50
CDH8B43B-3R9N	3.9u	22.00m	4.50
CDH8B43B-4R7N	4.7u	30.00m	4.0
CDH8B43B-6R8N	6.8u	33.00m	3.87
CDH8B43B-100M	10u	44.00m	3.10
CDH8B43B-150M	15u	75.00m	2.35
CDH8B43B-220M	22u	82.00m	1.90
CDH8B43B-330M	33u	125.00m	1.62
CDH8B43B-470M	47u	176.00m	1.35
CDH8B43B-680M	68u	247.00m	1.20
CDH8B43B-101M	100u	377.00m	1.02
CDH8B43B-121M	120u	429.00m	900m
CDH8B43B-151M	150u	520.00m	830m
CDH8B43B-181M	180u	624.00m	785m
CDH8B43B-221M	220u	793.00m	685m
CDH8B43B-271M	270u	962.00m	620m
CDH8B43B-331M	330u	1.23	540m

1. Inductance tolerance: M: ± 20%; N: ± 30%

2. Inductance measuring frequency: L ≤ 10uH at 100KHz/0.25V  
L > 10uH at 1KHz/0.25V

3. Rated current: The DC current at which the inductance decreases to 65% of its initial value or when Δt = 40°C, whichever is lower (Ta = 20°C).

## Wound Ferrite SMD Inductor for Power Circuit-----CDH10\*R Series

Operating Temp. : -40°C~125°C(including self-heating)



### Feature

- Ferrite drum core construction.
- Magnetically shielded.
- Moisture Sensitivity Level: 1
- RoHS compliance.
- Halogen Free available.

### Application

- Ideally used in Notebook PC, LCD TV,DVD,Game machine, STB ,Projector etc as DC-DC converter inductors.

### Production identification

CDH 103R 6R8 M T

① ② ③ ④ ⑤

① CDH
Series Name
③ Inductance value
6R8 -----> 6.8uH
100----->10uH
④ Inductance Tolerance
M-----> ± 20%
N-----> ± 30%

② External Dimensions (L x W x H.) [Unit: mm]
CDH103R 10.5 x 10.5 x 3.1
CDH104R 10.5 x 10.5 x 4.0
CDH105R 10.5 x 10.5 x 5.1

⑤ Packing Type
T---->Tape Carrier Package

### ※CDH10\*R Series

Dimensions and Land Patterns  
(UNIT: mm)

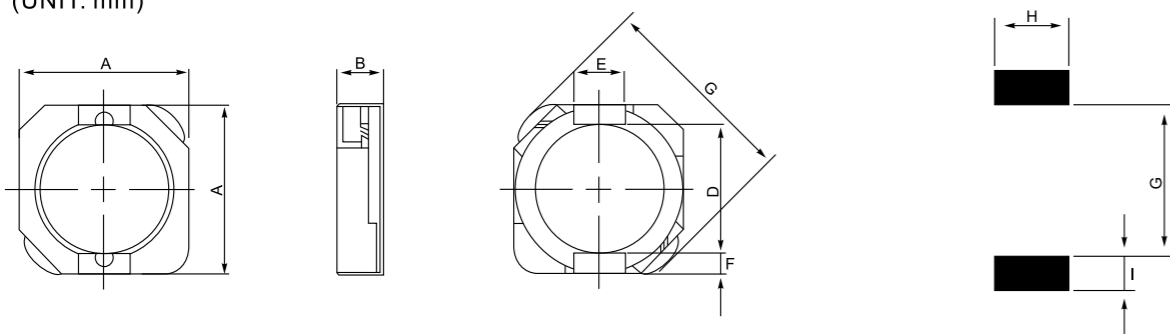

Series	A	B	C	D	E (Ref)	F (Ref)	G (Ref)	H (Ref)	I (Ref)
CDH103R	10.50	3.10	13.50	7.70	3.00	1.20	7.30	3.20	1.60
CDH104R	10.50	4.00	13.50	7.70	3.00	1.20	7.30	3.20	1.60
CDH105R	10.50	5.10	13.50	7.70	3.00	1.20	7.30	3.20	1.60

## Wound Ferrite SMD Inductor for Power Circuit-----CDH10\*R Series

Operating Temp. : -40°C~125°C(including self-heating)

### Electronic Characteristics List

Part Name	L(H)	D.C.R(Ω) : MAX.	Rated Current (A)※3
CDH103R-1R2	1.2u	12m(9m)	4.80
CDH103R-1R8	1.8u	14m(11m)	4.50
CDH103R-2R7	2.7u	18m(14m)	4.10
CDH103R-3R9	3.9u	22m(17m)	3.76
CDH103R-6R8	6.8u	36m(28m)	3.10
CDH103R-8R2	8.2u	42m(32m)	3.00
CDH103R-100	10u	52m(40m)	2.80
CDH103R-150	15u	62m(48m)	2.10
CDH103R-220	22u	91m(70m)	1.80
CDH103R-330	33u	150m(115m)	1.53
CDH103R-470	47u	208m(160m)	1.34
CDH103R-560	56u	228m(175m)	1.19
CDH103R-680	68u	289m(222m)	1.13
CDH103R-820	82u	312m(240m)	1.04
CDH103R-101	100u	377m(290m)	960m
CDH103R-121	120u	449m(345m)	882m
CDH103R-151	150u	607m(467m)	747m
CDH103R-181	180u	676m(520m)	688m
CDH103R-221	220u	826(635m)	666m
CDH103R-271	270u	933(718m)	580m
CDH103R-331	330u	1.14(880m)	513m
CDH103R-391	390u	1.43(1.10)	490m
CDH103R-471	470u	1.61(1.24)	450m
CDH104R-1R2	1.2u	12m(9.5m)	5.40
CDH104R-2R2	2.2u	17m(13m)	4.95
CDH104R-3R3	3.3u	22m(17m)	4.35
CDH104R-3R9	3.9u	26m(20m)	4.05
CDH104R-5R6	5.6u	33(25m)	3.80
CDH104R-100	10u	60m(46m)	3.15
CDH104R-150	15u	78m(60m)	2.90
CDH104R-220	22u	107m(82m)	2.50
CDH104R-330	33u	133m(102m)	2.00
CDH104R-470	47u	241m(185m)	1.80
CDH104R-560	56u	260m(200m)	1.62
CDH104R-680	68u	338m(260m)	1.35
CDH104R-820	82u	384m(295m)	1.26
CDH104R-101	100u	429m(330m)	1.17
CDH104R-151	150u	611m(470m)	1.05
CDH104R-221	220u	939m(722m)	900m
CDH104R-271	270u	1.17(900m)	720m
CDH104R-331	330u	1.30(1.00)	530m
CDH104R-391	390u	1.56(1.20)	450m
CDH104R-471	470u	1.76(1.35)	405m

1. Inductance tolerance: M: ± 20%; N: ± 30%

2. Inductance measuring frequency: L ≤ 10uH at 100KHz/0.25V  
L > 10uH at 1KHz/0.25V

3. Rated current: The DC current at which the inductance decreases to 65% of its initial value or when Δt=40°C, whichever is lower(Ta=20°C).

## Wound Ferrite SMD Inductor for Power Circuit-----CDH10\*R Series

Operating Temp. : -40°C~125°C(including self-heating )

### Electronic Characteristics List

Part Name	L(H)	D.C.R( $\Omega$ ) : MAX.	Rated Current (A)※3
CDH105R-1R2	1.2u	12.00m	8.30
CDH105R-1R5	1.5u	14.00m	8.30
CDH105R-2R2	2.2u	16.00m	7.50
CDH105R-3R3	3.3u	19.50m	6.50
CDH105R-4R7	4.7u	28.00m	5.50
CDH105R-5R6	5.6u	30.00m	4.50
CDH105R-6R8	6.8u	36.00m	4.90
CDH105R-100	10u	51.00m	4.00
CDH105R-150	15u	57.00m	3.30
CDH105R-180	18u	59.00m	3.10
CDH105R-220	22u	82.00m	2.90
CDH105R-330	33u	95.00m	2.60
CDH105R-470	47u	183.00m	2.00
CDH105R-560	56u	205.00m	1.80
CDH105R-680	68u	234.00m	1.60
CDH105R-820	82u	247.00m	1.40
CDH105R-101	100u	325.00m	1.35
CDH105R-151	150u	403.00m	1.10
CDH105R-181	180u	527.00m	1.00
CDH105R-221	220u	658.00m	940m
CDH105R-331	330u	775.00m	600m
CDH105R-471	470u	1.30	540m

1. Inductance tolerance: M:  $\pm 20\%$ ; N:  $\pm 30\%$

2. Inductance measuring frequency:  $L \leq 10\mu\text{H}$  at 100KHz/0.25V  
 $L > 10\mu\text{H}$  at 1KHz/0.25v

3. Rated current: The DC current at which the inductance decreases to 65% of it's initial value or when  $\Delta t = 40^\circ\text{C}$ , whichever is lower( $T_a = 20^\circ\text{C}$ ).

## Wound Ferrite SMD Inductor for Power Circuit-----12 Series

Operating Temp. : -40°C~125°C(including self-heating )

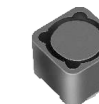

### Feature

- Ferrite drum core construction.
- Magnetically shielded.
- Moisture Sensitivity Level: 1
- RoHS compliance.
- Halogen Free available.

### Application

- Ideally used in Notebook PC, LCD TV, DVD, Game machine, STB, Projector etc. as DC-DC converter inductors.

### Production identification

CDH 124 6R8 M T

① ② ③ ④ ⑤

① CDH
Series Name

③ Inductance Value
6R8 -----> 6.8uH
100----->10uH

④ Inductance Tolerance
M-----> $\pm 20\%$
N-----> $\pm 30\%$

② External Dimensions (L x W x H.) [Unit: mm]	
CDH124	12.3 x 12.3 x 4.5
CDH125	12.3 x 12.3 x 6.0
CDH127	12.3 x 12.3 x 8.0

⑤ Packing Type
T---->Tape Carrier Package

### ※CDH12 Series

Dimensions and Land Patterns.

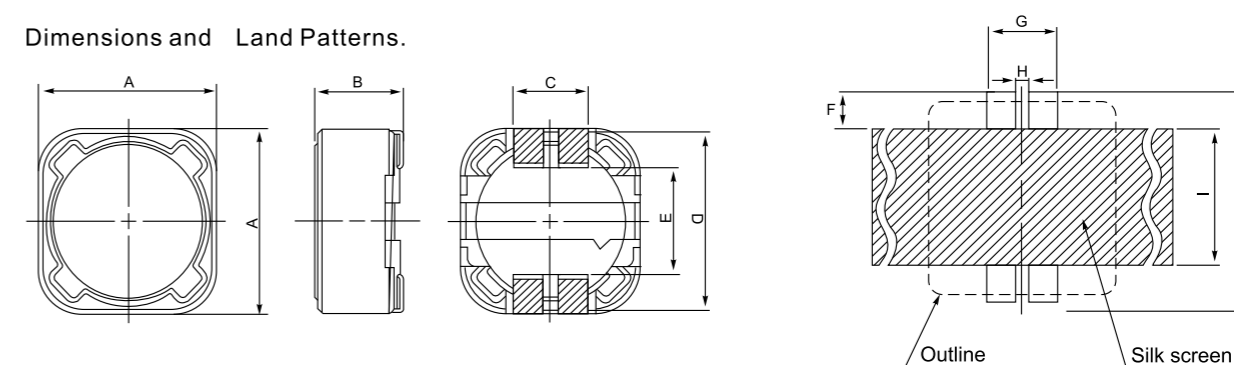

Series	A	B	C	D	E (Ref)	F (Ref)	G (Ref)	H (Ref)	I (Ref)	K (Ref)
CDH124	12.30	4.50	5.00	12.00	7.60	2.80	5.40	0.50	7.00	12.80
CDH125	12.30	6.00	5.00	12.00	7.60	2.80	5.40	0.50	7.00	12.80
CDH127	12.30	8.00	5.00	12.00	7.60	2.80	5.40	0.50	7.00	12.80

## Wound Ferrite SMD Inductor for Power Circuit-----12 Series

Operating Temp. : -40°C~125°C(including self-heating )

### Electronic Characteristics List

Part Name	L(H)	D.C.R(Ω) : MAX.	Rated Current (A)※3
CDH124-1R0N	1.0u	8m(6m)	7.80
CDH124-1R5N	1.5u	11m(8.8m)	7.20
CDH124-2R2N	2.2u	13m(10m)	6.00
CDH124-3R3N	3.3u	18m(14m)	5.40
CDH124-3R9N	3.9u	21m(16m)	5.10
CDH124-4R7N	4.7u	22m(17m)	4.80
CDH124-5R6N	5.6u	23m(18m)	4.30
CDH124-6R8N	6.8u	26m(20m)	4.20
CDH124-8R2N	8.2u	31m(24m)	4.00
CDH124-100M	10u	39m(30m)	3.90
CDH124-120M	12u	44m(34m)	3.40
CDH124-150M	15u	55m(42m)	3.20
CDH124-180M	18u	65m(50)	2.90
CDH124-220M	22u	75m(58m)	2.50
CDH124-270M	27u	86m(66m)	2.25
CDH124-330M	33u	112m(86m)	2.00
CDH124-390M	39u	121m(93m)	1.90
CDH124-470M	47u	166m(128m)	1.80
CDH124-560M	56u	182m(140m)	1.70
CDH124-680M	68u	205m(158m)	1.55
CDH124-820M	82u	243m(187m)	1.35
CDH124-101M	100u	299m(230m)	1.20
CDH124-121M	120u	358m(275m)	1.10
CDH124-151M	150u	462m(355m)	950m
CDH124-181M	180u	507m(390m)	850m
CDH124-221M	220u	663m(510m)	800m
CDH124-271M	270u	741m(570m)	650m
CDH124-331M	330u	936m(720m)	550m
CDH124-391M	390u	1.05(810m)	500m
CDH124-471M	470u	1.30(1.00)	440m
CDH124-561M	560u	1.53(1.18)	400m
CDH124-681M	680u	1.72(1.32)	370m
CDH124-821M	820u	2.21(1.70)	350m
CDH124-102M	1000u	2.67(2.05)	320m
CDH125-1R0N	1.0u	11.00m	8.50
CDH125-2R2N	2.2u	15.50m	6.50
CDH125-3R3N	3.3u	18.00m	5.70
CDH125-4R7N	4.7u	20.50m	4.70
CDH125-5R6N	5.6u	21.00m	4.70
CDH125-6R8N	6.8u	14.30m	4.40
CDH125-100M	10u	25.00m	4.00
CDH125-120M	12u	27.00m	3.50
CDH125-150M	15u	30.00m	3.30
CDH125-180M	18u	38.40m	3.00
CDH125-220M	22u	46.00m	2.80
CDH125-270M	27u	52.00m	2.30
CDH125-330M	33u	70.00m	2.10
CDH125-390M	39u	76.00m	2.00
CDH125-470M	47u	85.00m	1.80
CDH125-560M	56u	110.00m	1.70
CDH125-680M	68u	120.00m	1.50

## Wound Ferrite SMD Inductor for Power Circuit-----12 Series

Operating Temp. : -40°C~125°C(including self-heating )

### Electronic Characteristics List

Part Name	L(H)	D.C.R(Ω) : MAX.	Rated Current (A)※3
CDH125-820M	82u	162.00m	1.40
CDH125-101M	100u	170.00m	1.30
CDH125-121M	120u	206.00m	1.10
CDH125-151M	150u	280.00m	1.00
CDH125-181M	180u	310.00m	900m
CDH125-221M	220u	350.00m	800m
CDH125-271M	270u	440.00m	750m
CDH125-331M	330u	570.00m	680m
CDH125-391M	390u	685.00m	650m
CDH125-471M	470u	905.00m	580m
CDH125-561M	560u	1000.00m	540m
CDH127-1R0N	1.0u	6.50m	10.40
CDH127-1R5N	1.5u	8.50m	9.20
CDH127-2R2N	2.2u	11.00m	8.40
CDH127-2R7N	2.7u	12.20m	7.80
CDH127-3R3N	3.3u	13.00m	7.60
CDH127-3R9N	3.9u	14.00m	7.20
CDH127-4R7N	4.7u	15.80m	6.80
CDH127-5R6N	5.6u	16.70m	6.70
CDH127-6R8N	6.8u	18.40m	6.50
CDH127-7R6N	7.6u	20.00m	5.90
CDH127-100M	10u	23.40m	5.40
CDH127-120M	12u	26.00m	4.90
CDH127-150M	15u	28.60m	4.50
CDH127-180M	18u	39.20m	3.90
CDH127-220M	22u	43.20m	3.60
CDH127-270M	27u	51.09m	3.30
CDH127-330M	33u	64.80m	3.00
CDH127-390M	39u	72.90m	2.75
CDH127-470M	47u	100.00m	2.50
CDH127-560M	56u	110.00m	2.35
CDH127-680M	68u	140.00m	2.10
CDH127-820M	82u	160.00m	1.95
CDH127-101M	100u	220.00m	1.70
CDH127-121M	120u	250.00m	1.60
CDH127-151M	150u	280.00m	1.42
CDH127-181M	180u	290.00m	1.30
CDH127-221M	220u	299.00m	1.16
CDH127-271M	270u	403.00m	1.06
CDH127-331M	330u	455.00m	950m
CDH127-391M	390u	494.00m	880m
CDH127-471M	470u	689.00m	790m
CDH127-561M	560u	793.00m	730m

1. Inductance tolerance: M: ± 20%; N: ± 30%

2. Inductance measuring frequency: L≤10uH at 100KHz/0.25V  
L>10uH at 1KHz/0.25v

3. Rated current: The DC current at which the inductance decreases to 65% of it's initial value or when Δt=40°C, whichever is lower(Ta=20°C).

## Wound Ferrite SMD Inductor for Power Circuit-----BF Series

Operating Temp. : -40°C~125°C(including self-heating)



### Feature

- Shielded construction
- Mn-Zn Ferrite core ,High DC Saturation Current
- 100% Pb lead(Pb) free meet RoHS standard

### Application

- Ideal for Communication Power Supply.

### Production identification

BF 1608 6R8 M T

① ② ③ ④ ⑤

① BF
Series Name
③ Inductance value
6R8 -----> 6.8uH
100----->10uH
④ Inductance Tolerance
M-----> ± 20%
N-----> ± 30%

② External Dimensions (L x W x H.) [Unit: mm]	
BF1608	6.9 x 4.5 x 2.9
BF3316	13.5 x 10.0 x 51.0
BF5022	19.0 x 14.3 x 7.1

⑤ Packing Type	
T---->	Tape Carrier Package

### ※BF Series

Dimensions and Land Patterns  
(UNIT: mm)

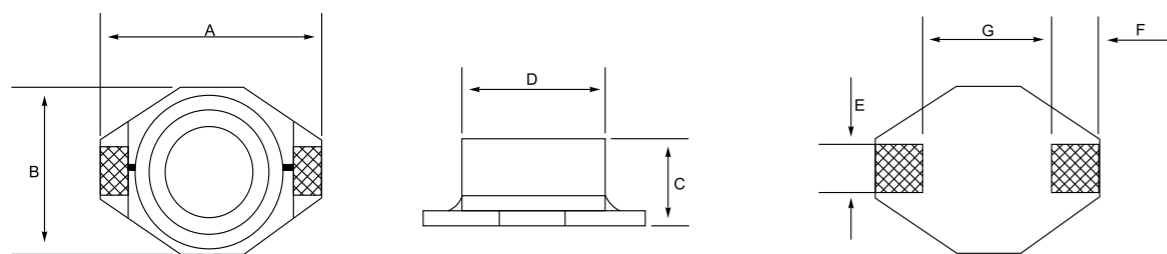

TYPE	A(max)	B(max)	C(max)	D	E	F	G
BF1608	6.9	4.5	2.9	4.00	1.20	1.15	4.20
BF3316	13.5	10.0	5.1	8.38	2.54	2.54	7.62
BF5022	19.0	15.2	7.1	12.70	2.54	2.54	12.70

## Wound Ferrite SMD Inductor for Power Circuit-----BF Series

Operating Temp. : -40°C~125°C(including self-heating)

### Electronic Characteristics List

Part Name	L(H)	D.C.R(Ω) : MAX.	Rated Current (A)※1
BF1608-1R0N	1.0u	16m(12m)	1.50
BF1608-1R5N	1.5u	18m(14m)	1.18
BF1608-2R2N	2.2u	23m(18m)	1.08
BF1608-3R3N	3.3u	29m(22m)	800m
BF1608-4R7N	4.7u	46m(35m)	600m
BF1608-6R8N	6.8u	60m(43m)	560m
BF1608-100M	10u	80m(61m)	400m
BF1608-150M	15u	102m(78m)	330m
BF1608-220M	22u	128m(99m)	300m
BF1608-330M	33u	169m(130m)	270m
BF1608-470M	47u	228m(175m)	220m
BF1608-680M	68u	332m(255m)	170m
BF1608-101M	100u	520m(400m)	140m
BF1608-151M	150u	800m(610m)	110m
BF1608-221M	220u	1.08m(830m)	90m
BF1608-331M	330u	1.56(1.20)	67m
BF1608-471M	470u	2.20(1.70)	54m
BF3316-1R5N	1.5u	23m(18m)	3.80
BF3316-3R3N	3.3u	35m(27m)	2.50
BF3316-4R7N	4.7u	44m(34m)	2.10
BF3316-6R8N	6.8u	57m(44m)	2.00
BF3316-100 M	10u	99m(76m)	1.60
BF3316-150M	15u	134m(103m)	1.35
BF3316-220M	22u	228m(175m)	1.10
BF3316-330M	33u	325m(250m)	810m
BF3316-470M	47u	403m(310m)	730m
BF3316-680M	68u	585m(450m)	640m
BF3316-101M	100u	793m(610m)	520m
BF3316-151M	150u	1.80(1.39m)	430m
BF3316-221M	220u	2.15(1.65)	340m
BF3316-331M	330u	2.67(2.05)	270m
BF3316-471M	470u	3.90(3.00)	190m
BF3316-681M	680u	5.85(4.50)	170m
BF3316-102M	1000u	8.32(4.50)	140m
BF5022-1R0N	1.0u	16m(12.5m)	6.50
BF5022-2R2N	2.2u	23m(18m)	5.00
BF5022-3R3N	3.3u	26m(20m)	4.70
BF5022-4R7N	4.7u	28m(22m)	4.40
BF5022-5R6N	5.6u	30m(23m)	4.10
BF5022-100M	10u	40m(31m)	3.90
BF5022-150M	15u	48m(37m)	3.40
BF5022-220M	22u	59m(45m)	3.10
BF5022-330M	33u	75m(58m)	2.80
BF5022-470M	47u	97m(75m)	2.40
BF5022-680M	68u	138(106m)	2.00
BF5022-101M	100u	207m(158m)	1.70
BF5022-151M	150u	293m(225m)	1.30
BF5022-221M	220u	470m(365m)	1.10
BF5022-331M	330u	780m(600m)	860m
BF5022-471M	470u	1.08(830m)	730m

1. Inductance tolerance: M: ± 20%; N: ± 30%

2. Inductance measuring frequency: L≤10uH at 100KHz/0.25V  
L>10uH at 1KHz/0.25v

3. Rated current: The DC current at which the inductance decreases to 65% of it's initial value or when Δt=40°C, whichever is lower(Ta=20°C).

## Wound Ferrite SMD Inductor for Power Circuit-----B Series

Operating Temp. : -40°C~125°C(including self-heating)



### Feature

- Un-shielded construction
- Mn-Zn Ferrite core ,High DC Saturation Current
- 100% Pb lead(Pb) free meet RoHS standard

### Application

- Ideal for Communication Power Supply.

### Production identification

**B 1608 6R8 M T**  
 ① ② ③ ④ ⑤

① B
Series Name
③ Inductance value
6R8 -----> 6.8uH
100----->10uH
④ Inductance Tolerance
M-----> ± 20%
N-----> ± 30%

② External Dimensions (L x W x H.) [Unit: mm]	
B1608	7.0 x 4.5 x 2.9
B3316	13.5 x 10.0 x 5.5
B3340	13.5 x 10.0 x 11.4
B5022	19.0 x 14.3 x 7.1

⑤ Packing Type	
T----->	Tape Carrier Package

### ※B Series

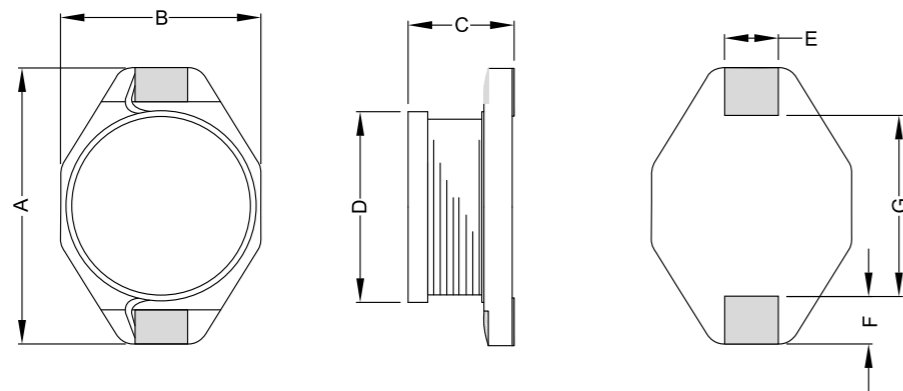

TYPE	A(max)	B(max)	C(max)	D	E	F	G
B1608	7.0	4.5	2.9	4.00	1.20	1.15	4.20
B3316	13.5	10.0	5.5	8.40	2.54	2.54	7.62
B3340	13.5	10.0	11.4	8.40	2.54	2.54	7.62
B5022	19.0	14.3	7.1	12.70	2.54	2.54	12.70

## Wound Ferrite SMD Inductor for Power Circuit-----B Series

Operating Temp. : -40°C~125°C(including self-heating)

### Electronic Characteristics List

Part Name	L(H)	D.C.R(Ω) : MAX.	Rated Current (A)※3
B1608-1R2M	1.2u	31m(24m)	2.88
B1608-1R5M	1.5u	34m(26m)	2.70
B1608-2R2M	2.2u	47m(36m)	2.25
B1608-3R3M	3.3u	65m(50m)	1.75
B1608-4R7M	4.7u	86m(66m)	1.40
B1608-6R8M	6.8u	117m(90m)	1.30
B1608-100K	10u	189m(145m)	1.05
B1608-150K	15u	286m(220m)	810m
B1608-220K	22u	364m(280m)	700m
B1608-330K	33u	650m(500m)	530m
B1608-470K	47u	845m(650m)	450m
B1608-680K	68u	1.12(860m)	370m
B1608-101K	100u	1.66(1.28)	310m
B1608-151K	150u	2.93(2.25)	220m
B1608-221K	220u	3.90(3.00)	180m
B1608-331K	330u	6.31(4.85)	160m
B3316-1R2M	1.2u	8.5m(6.5m)	6.10
B3316-1R5M	1.5u	9m(7m)	5.70
B3316-2R2M	2.2u	12m(9m)	5.00
B3316-3R3M	3.3u	18m(14m)	4.30
B3316-3R9M	3.9u	20m(15m)	4.00
B3316-4R7M	4.7u	21m(16m)	3.78
B3316-5R6M	5.6u	25m(19m)	3.70
B3316-6R8M	6.8u	29m(22m)	3.50
B3316-8R2M	8.2u	31m(24m)	3.40
B3316-100K	10u	36m(28m)	3.06
B3316-150K	15u	56m(43m)	2.80
B3316-220K	22u	75m(58m)	2.25
B3316-270K	27u	91m(70m)	1.98
B3316-330K	33u	111m(85m)	1.80
B3316-390K	39u	121m(93m)	1.71
B3316-470K	47u	156m(120m)	1.62
B3316-560K	56u	178m(137m)	1.50
B3316-680K	68u	208m(160m)	1.33
B3316-820K	82u	260m(200m)	1.21
B3316-101K	100u	317m(244m)	1.08
B3316-151K	150u	471m(362m)	900m
B3316-181K	180u	533m(410m)	792m
B3316-221K	220u	663m(510m)	720m
B3316-331K	330u	1.03(790m)	600m
B3316-391K	390u	1.21(930m)	550m
B3316-471K	470u	1.50(1.15)	500m
B3316-561K	560u	1.70(1.30)	405m
B3316-681K	680u	2.08(1.60)	350m
B3316-821K	820u	2.50(1.91)	300m
B3316-102K	1000u	3.12(2.40)	270m

1. Inductance tolerance: M: ± 20%; K ± 10%

2. Inductance measuring frequency: L≤10uH at 100KHz/0.25V  
 L>10uH at 1KHz/0.25v

3. Rated current: The DC current at which the inductance decreases to 90% of it's initial value or when Δt=40°C, whichever is lower(Ta=20°C).

## Wound Ferrite SMD Inductor for Power Circuit-----B Series

Operating Temp. : -40°C~125°C(including self-heating )

### Electronic Characteristics List

Part Name	L(H)	D.C.R( $\Omega$ ) : MAX.	Rated Current (A)※3
B3340-1R0N	1.0u	7.7m(4m)	9.80
B3340-1R2N	1.2u	10m(6m)	9.00
B3340-1R5N	1.5u	12m(6.5m)	8.50
B3340-3R3N	3.3u	14.3m(10m)	7.00
B3340-4R7N	4.7u	15.6m(11m)	6.50
B3340-6R8N	6.8u	17m(13m)	6.00
B3340-100M	10u	30m(23m)	4.10
B3340-150M	15u	36m(28m)	3.80
B3340-220M	22u	52m(40m)	3.00
B3340-330M	33u	70m(54m)	2.50
B3340-470M	47u	99m(76m)	2.00
B3340-680M	68u	144m(111m)	1.70
B3340-101M	100u	182m(140m)	1.35
B3340-151M	150u	334m(257m)	1.10
B3340-221M	220u	436m(335m)	1.00
B3340-331M	330u	689m(530m)	765m
B3340-471M	470u	1.00(770m)	600m
B3340-681M	680u	1.43(1.10)	495m
B3340-102M	1000u	2.08(1.60)	430m
B5022-1R5N	1.5u	7m(5m)	8.50
B5022-2R2N	2.2u	8m(6m)	7.20
B5022-3R3N	3.3u	13m(10m)	6.30
B5022-5R6N	5.6u	20m(15m)	5.30
B5022-6R8N	6.8u	21m(16m)	4.90
B5022-100M	10u	23m(18m)	4.30
B5022-150M	15u	33m(25m)	3.85
B5022-220M	22u	52m(40m)	3.15
B5022-330M	33u	75m(58m)	2.50
B5022-470M	47u	98m(75m)	2.10
B5022-560M	56u	105m(81m)	2.00
B5022-680M	68u	120m(92m)	1.80
B5022-101M	100u	218m(168m)	1.35
B5022-151M	150u	317m(244m)	1.15
B5022-221M	220u	433m(333m)	1.00
B5022-331M	330u	644m(495m)	810m
B5022-471M	470u	932m(717m)	675m
B5022-561M	560u	1.16(892m)	585m
B5022-681M	680u	1.47(1.13)	530m
B5022-102M	1000u	2.05(1.58)	440m

※ 测试条件:  $L \leq 8.2\mu\text{H}$  测试频率100KHz / 0.25V, (M  $\pm$  20%);

$L > 8.2\mu\text{H}$  测试频率1KHz / 0.25V, (K  $\pm$  10%);

※ 测试仪表: HP4291B、502BC、CH1062。

## Ultra-small SMD Wound Ferrite Common Mode Choke---CM/PCM/TCM Series

Operating Temp. : -25°C~85°C ; Storage Temp. and Humidity : -25°C~85°C , 70%RH max.

### Feature

- Winding type realizes small size and low profile
- Prevention of common mode noise at high frequency
- Ideal for different noise level and signal frequency
- Excellent solder ability

### Application

- CM Series : Used in USB/DVI/HDMI/USB3.0/DP PORT  
A Type : USB2.0/IEEE1394 for normal speed  
C Type : C TYPE : DVI/HDMI1.4/Display-Port(DP) for Ultra-speed.  
D Type : USB3.0 / DP-II for Ultra-speed.
- PCM Series : Used in DC Power Supply input for filter
- TCM Series : Used in LAN Port(RJ45) filter
- CF Series : Used in Vehicle electronic for EMI

### Production identification

CM 0806 D 350 S

① ② ③ ④ ⑤

CM ①  
Product Name

D ③  
Classification  
D: USB3.0/7.5GHz

350 ④  
Impedance value  
350 : 35 $\Omega$  at 100MHz

External Dimensions {L x W x H[max.]} [Unit: mm]	
0806	0.85 x 0.65 x 0.45
1210	1.20 x 1.00 x 0.90
1608	1.60 x 0.80 x 1.20
2012	2.00 x 1.20 x 1.40
3216	3.20 x 1.60 x 2.10

S ⑤
Tolerance
M : $\pm$ 20%
S : $\pm$ 25%

### ※CM series

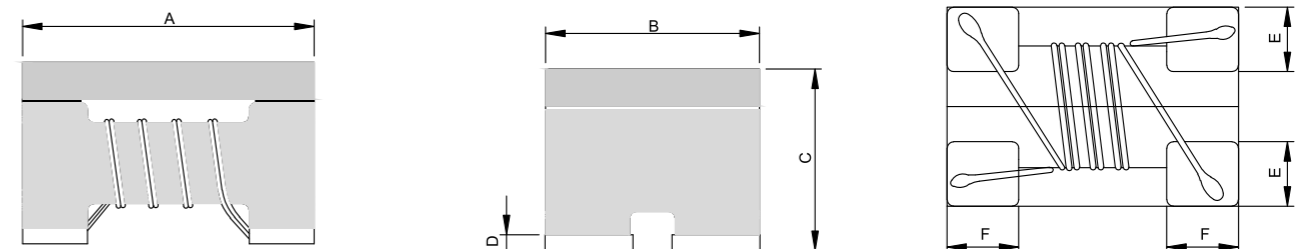

Series	A	B	C	D(max.)	E (Typ.)	F (Typ.)
0806	0.85 $\pm$ 0.1	0.65 $\pm$ 0.1	0.45 max.	0.15 max.	0.27	0.22
1210	1.2 $\pm$ 0.2	1.0 $\pm$ 0.2	0.9 max.	0.15 max.	0.36	0.33
1608	1.6 $\pm$ 0.1	0.8 $\pm$ 0.1	1.1 $\pm$ 0.1	0.1 $\pm$ 0.1	0.25	0.33
2012	2.0 $\pm$ 0.2	1.2 $\pm$ 0.2	1.2 $\pm$ 0.2	0.2 $\pm$ 0.1	0.40	0.45
3216	3.2 $\pm$ 0.2	1.6 $\pm$ 0.2	1.9 $\pm$ 0.2	0.2 $\pm$ 0.1	0.60	0.60

## Ultra-small SMD Wound Ferrite Common Mode Choke---CM/PCM/TCM Series

Operating Temp. : -25°C~85°C ; Storage Temp. and Humidity : -25°C~85°C , 70%RH max.

### Electrical Characteristics

Part No.	Common Impedance Z(Ω) at 100MHz	DCR (Ω)	Rate Current Max.(mA)	Rate Voltage Typ.(V)	Insulation Resistance (MΩ)	Cut-off Frequency (Ghz)	Characteristic Resistance Typ. (Ω)
CM0806D-350□	35	0.55	100	10	10	7.5	-
CM0806D-650□	65	0.80	100	10	10	7.5	-
CM0806D-900□	90	1.00	100	10	10	7.5	-
CM1210A-161□	160	0.60	260	20	10	1.0	-
CM1210A-221□	220	0.70	230	20	10	1.0	-
CM1210A-331□	330	0.80	200	20	10	1.0	-
CM1210B-900□	90	0.50	280	20	10	3.5	90
CM1210C-121□	120	0.55	270	20	10	6.0	90
CM1210D-250□	25	0.30	300	20	10	7.5	90
CM1210D-600□	60	0.40	300	20	10	7.5	90
CM1210D-900□	90	0.50	280	20	10	7.5	90
CM2012B-900□	90	0.30	300	20	10	3.5	100
CM2012C-240□	24	0.20	300	20	10	6.0	100
CM2012C-300□	30	0.20	300	20	10	6.0	100
CM2012C-600□	60	0.30	300	20	10	6.0	100
CM2012C-900□	90	0.30	300	20	10	6.0	100
CM2012D-120N	12	0.25	420	20	10	7.5	100
CM2012D-240□	24	0.25	420	20	10	7.5	100
CM2012D-250□	25	0.22	420	20	10	7.5	100
CM2012D-320□	32	0.25	400	20	10	7.5	100
CM2012D-600□	60	0.30	300	20	10	7.5	100
CM2012D-900□	90	0.30	300	20	10	7.5	100

Part No.	Common Impedance Z(Ω) at 100MHz	DCR (Ω)	Rate Current Max.(mA)	Rate Voltage Typ.(V)	Insulation Resistance IR (MΩ)Min.	Withstanding Voltage Vdc (V)Typical
CM1608A-670□	67	0.30	300	50	10	125
CM1608A-900□	90	0.30	300	50	10	125
CM1608A-121□	120	0.36	250	50	10	125
CM1608A-161□	160	0.40	200	50	10	125
CM1608A-221□	220	0.42	200	50	10	125
CM2012A-670□	67	0.26	400	50	10	125
CM2012A-900□	90	0.30	400	50	10	125
CM2012A-121□	120	0.30	350	50	10	125
CM2012A-161□	160	0.30	350	50	10	125
CM2012A-181□	180	0.35	330	50	10	125
CM2012A-221□	220	0.35	330	50	10	125
CM2012A-261□	260	0.40	300	50	10	125
CM2012A-361□	360	0.40	280	50	10	125
CM3216A-670□	67	0.25	400	50	10	125
CM3216A-900□	90	0.30	400	50	10	125
CM3216A-121□	120	0.35	370	50	10	125
CM3216A-161□	160	0.40	340	50	10	125
CM3216A-261□	260	0.50	310	50	10	125
CM3216A-361□	360	0.60	290	50	10	125
CM3216A-601□	600	0.80	260	50	10	125
CM3216A-102□	1000	1.00	230	50	10	125
CM3216A-222□	2200	1.20	200	50	10	125

## Ultra-small SMD Wound Ferrite Common Mode Choke---CM/PCM/TCM Series

Operating Temp. : -25°C~85°C ; Storage Temp. and Humidity : -25°C~85°C , 70%RH max.

### Feature

- Winding type realizes small size and low profile
- Prevention of common mode noise at high frequency
- Ideal for different noise level and signal frequency
- Excellent solder ability

### Application

- CM Series : Used in USB/DVI/HDMI/USB3.0/DP PORT  
A Type : USB2.0/IEEE1394 for normal speed  
C Type : C TYPE : DVI/HDMI1.4/Display-Port(DP) for Ultra-speed.  
D Type : USB3.0 / DP-II for Ultra-speed.
- PCM Series : Used in DC Power Supply input for filter
- TCM Series : Used in LAN Port(RJ45) filter
- CF Series : Used in Vehicle electronic for EMI

### Production identification

PCM/TCM ①      2520 ②      D ③      350 ④      S ⑤

PCM/TCM ①
Product Name

D ③
Classification
D: USB3.0/7.5GHZ

350 ④
Impedance value
350 : 35Ω at 100MHz

External Dimensions {L×W×H[max.]} [Unit: mm]	
2520	2.5 × 2.5 × 1.2
3225	1.20 × 1.00 × 0.90
4532	1.60 × 0.80 × 1.20

S ⑤
Tolerance
M : ±20%
S : ±25%

### ※PCM/TCM Series

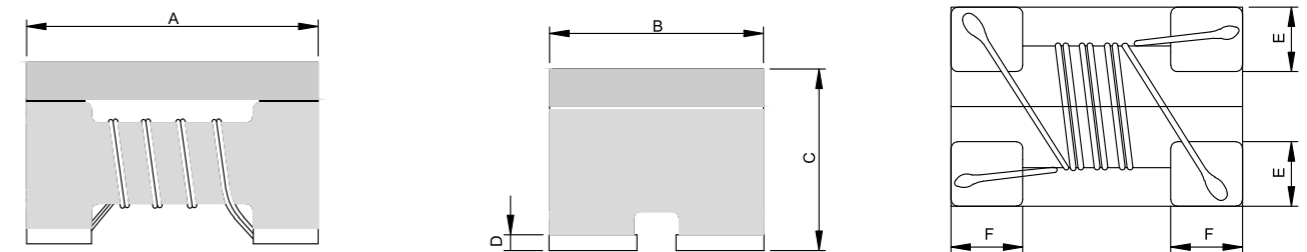

Series	A	B	C	D	E	F
2520	2.5 ± 0.2	2.0 ± 0.2	1.2 ± 0.2	0.2 ± 0.1	0.50 ± 0.1	0.45 ± 0.1
3225	3.2 ± 0.2	2.5 ± 0.2	2.2 ± 0.2	0.2 ± 0.1	0.80 Typ	0.65 Typ
4532	4.5 ± 0.2	3.2 ± 0.2	2.8 ± 0.2	0.2 ± 0.1	1.2 Typ.	1.0 Typ.



## Ultra-small SMD Wound Ferrite Common Mode Choke---CM/PCM/TCM Series

Operating Temp. : -25°C~85°C ; Storage Temp. and Humidity : -25°C~85°C , 70%RH max.

### Electrical Characteristics

Part No.	Common Impedance Z(Ω) at 100MHz	DCR (Ω)	Rate Current Max.(mA)	Rate Voltage Typ.(V)	Insulation Resistance IR (MΩ)Min.
PCM3225A-800S	80	0.15	2.0	50	10
PCM3225A-601S	600	0.25	1.0	50	10
PCM3225-102S	1000	0.35	1.2	50	10
PCM4532A-102S	1000	0.40	1.0	50	10
PCM4532A-601S	600	0.30	1.5	50	10
PCM4532A-801S	800	0.10	1.0	50	10
TCM2520-601-3P	600	1.20	200	20	10
TCM2520-801-3P	800	1.60	150	20	10

## Ultra-small SMD Wound Ferrite Common Mode Choke---CM/PCM/TCM Series

Operating Temp. : -25°C~85°C ; Storage Temp. and Humidity : -25°C~85°C , 70%RH max.

### Feature

- Winding type realizes small size and low profile
- Prevention of common mode noise at high frequency
- Ideal for different noise level and signal frequency
- Excellent solder ability

### Application

- CM Series : Used in USB/DVI/HDMI/USB3.0/DP PORT  
A Type : USB2.0/IEEE1394 for normal speed  
C Type : C TYPE : DVI/HDMI1.4/Display-Port(DP) for Ultra-speed.  
D Type : USB3.0 / DP-II for Ultra-speed.
- PCM Series : Used in DC Power Supply input for filter
- TCM Series : Used in LAN Port(RJ45) filter
- CF Series : Used in Vehicle electronic for EMI

### Production identification

BT ①      0806 ②      D ③      350 ④      S ⑤

BT ①
Product Name

D ③
Classification
D: USB3.0/7.5GHz

350 ④
Impedance value
350 : 35Ω at 100MHz

External Dimensions {L×W×H[max.]} [Unit: mm]	
2012	2.0 × 2.0 × 1.2

S ⑤
Tolerance
M : ± 20%
S : ± 25%

### ※BT Series

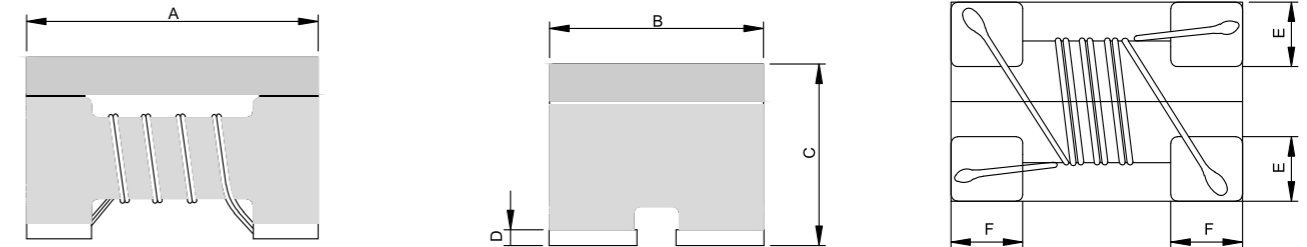

Series	A	B	C	D	E (Typ.)	F (Typ.)
2012	2.0 ± 0.2	1.2 ± 0.2	1.2 ± 0.2	0.2 ± 0.1	0.40	0.45

## Ultra-small SMD Wound Ferrite Common Mode Choke---CM/PCM/TCM Series

Operating Temp. : -25°C~85°C ; Storage Temp. and Humidity : -25°C~85°C , 70%RH max.

### Electrical Characteristics

Part No.	Freq. Range (MHZ)	UB/B Impedance (MΩ)	Insertion Loss (dB) Max	CMRR (dB) Min	Rated Voltage (DC) (V)	DCR (Ω)	Withstand Voltage (DC) (V)	Insulation Resistance Min. (MΩ)	Idc (mA)
BT2012A-750	45~870	75/75	1.0	20	50	-	125	10	-
BT2012H-750	50~1200	75/75	1.2	20	20	0.7	125	10	280

Insertion Loss Characteristics

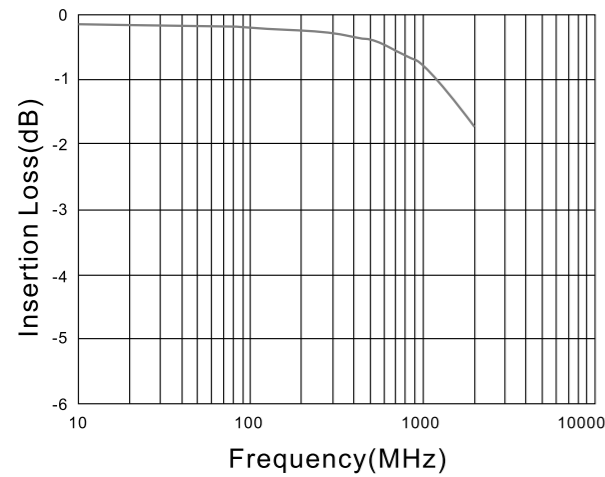

CMRR Characteristics

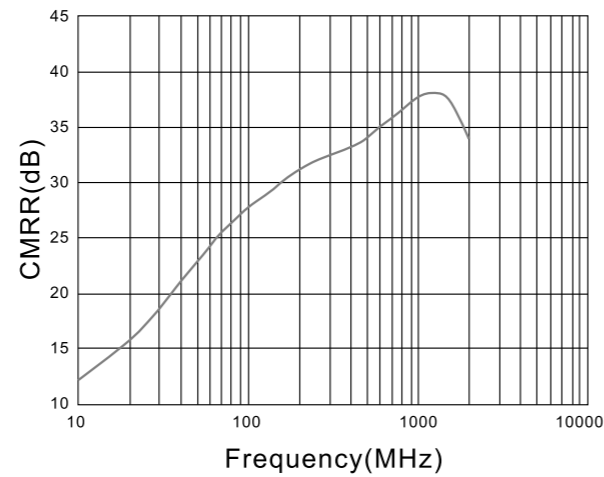

## Ultra-small SMD Wound Ferrite Common Mode Choke---CM/PCM/TCM Series

Operating Temp. : -25°C~85°C ; Storage Temp. and Humidity : -25°C~85°C , 70%RH max.

### Feature

- Winding type realizes small size and low profile
- Prevention of common mode noise at high frequency
- Ideal for different noise level and signal frequency
- Excellent solder ability

### Application

- CM Series : Used in USB/DVI/HDMI/USB3.0/DP PORT  
A Type : USB2.0/IEEE1394 for normal speed  
C Type : C TYPE : DVI/HDMI1.4/Display-Port(DP) for Ultra-speed.  
D Type : USB3.0 / DP-II for Ultra-speed.
- PCM Series : Used in DC Power Supply input for filter
- TCM Series : Used in LAN Port(RJ45) filter
- CF Series : Used in Vehicle electronic for EMI

### Production identification

CF 4532 A 101

① ② ③ ④ ⑤

CF ①
Product Name

External Dimensions {L×W×H[max.]} [Unit: mm]	
4532	4.5 × 4.5 × 2.8

D ③
Classification
D: USB3.0/7.5GHz

S ⑤
Tolerance
M: ±20%
S: ±25%

350 ④
Impedance value
350: 35Ω at 100MHz

### ※BT Series

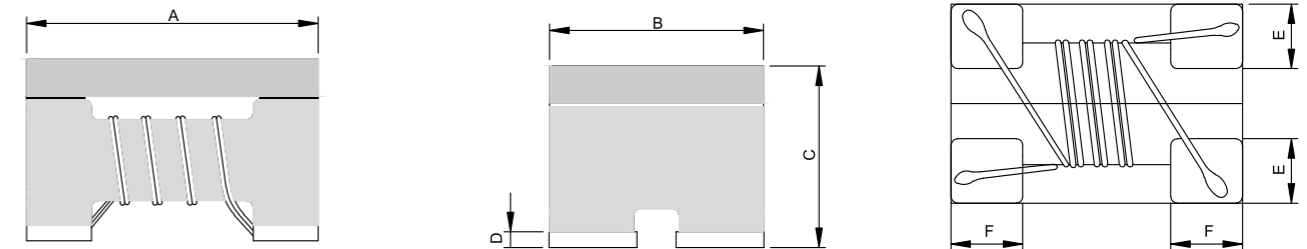

Series	A	B	C	D	E (Typ.)	F (Typ.)
4532	4.5 ± 0.2	3.2 ± 0.2	2.8 ± 0.2	0.2 ± 0.1	1.2	1.0

## Ultra-small SMD Wound Ferrite Common Mode Choke---CM/PCM/TCM Series

Operating Temp. : -25°C~85°C ; Storage Temp. and Humidity : -25°C~85°C , 70%RH max.

### Electrical Characteristics

P/N	Z(Ω)		L(μH)		DCR (Ω)	Idc(mA)	Rated Voltage	Insulation Resistance
	Common Mode		Common Mode					
	Impedance		Inductance					
		at 10MHz		at 100KHz	[ Max ]	[ Max ]	Vdc (V)Typical	IR (MΩ)Min.
CF 4532A-101	min.	2000	(+50%/-30%)	100	3.00	150	50	10
	typ.	5000						
CF 4532A-110	min.	300	(+50%/-30%)	11	0.60	250	50	10
	typ.	700						
CF 4532A-220	min.	500	(+50%/-30%)	22	1.00	200	50	10
	typ.	1000						
CF 4532A-510	min.	1000	(+50%/-30%)	51	1.00	200	50	10
	typ.	2000						

## Wire Wound Chip Inductors-----WI Series

Operating Temp. : -40°C~125°C(including self-heating )

### Feature

- Miniature size, suitable for surface mounting
- High Q value and high self-resonant frequency with ceramic material
- Excellent in solder ability and heat resistance

### Application

- High frequency circuit in telecommunication and other equipment
- Mobile phones such as GSM,CDMA, PDC ,etc.
- Bluetooth ,W-LAN, Broadband network.

### Production identification

WI      C      1005 - 1N0      K

①      ②      ③      ④      ⑤

① WI  
Series Name

② WI  
Material Name  
C : Ceramic  
F : Ferrite

③ External Dimensions (L×W) [Unit: mm]	

④ 1N0	
Inductance value	
1N0 : 1.0nH	
010 : 10nH	
015 : 15nH	

### ※WI Series

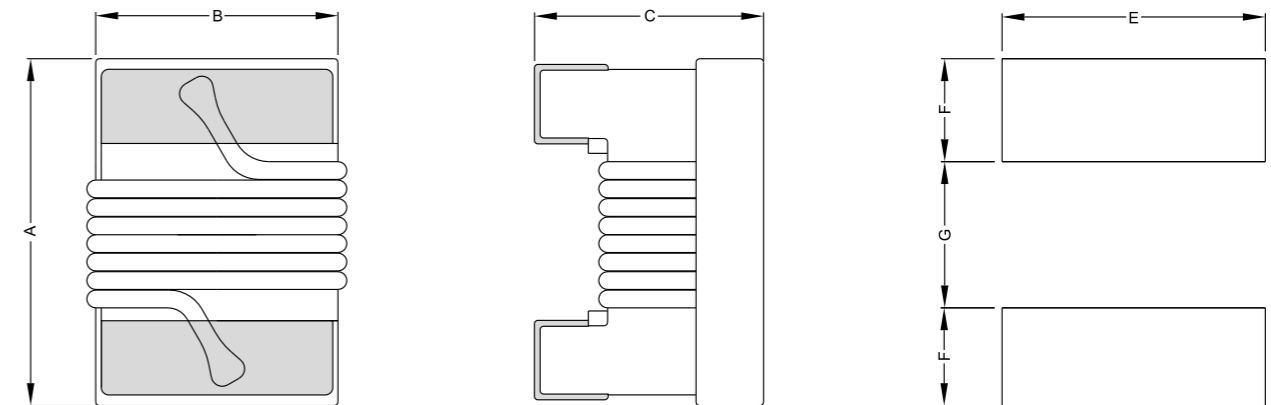

TYPE(型式)	A	B	C	D	E	F	G
WIC1005(0402)	1.2 ± 0.10	0.60 ± 0.10	0.60 ± 0.10	0.23 ± 0.05	0.23 ± 0.05	0.40 ± 0.05	0.64 ± 0.05
WIC1608(0603)	1.68 ± 0.10	1.00 ± 0.10	0.85 ± 0.10	0.30 ± 0.05	0.30 ± 0.05	0.64 ± 0.05	0.64 ± 0.05
W□2012(0805)	2.20 ± 0.10	1.60 ± 0.10	1.30 ± 0.10	0.50 ± 0.07	0.50 ± 0.07	1.02 ± 0.05	0.76 ± 0.05
W□2520(1008)	2.65 ± 0.10	2.60 ± 0.10	2.00 ± 0.10	0.50 ± 0.07	0.50 ± 0.07	1.02 ± 0.05	1.27 ± 0.05
W□3225(1210)	3.35 ± 0.15	2.70 ± 0.10	2.10 ± 0.10	0.50 ± 0.07	0.50 ± 0.07	1.02 ± 0.05	1.78 ± 0.05
WIF4535(1812)	4.65 ± 0.20	3.25 ± 0.10	3.00 ± 0.10	0.65 ± 0.07	0.65 ± 0.07	1.14 ± 0.05	3.00 ± 0.05

## Wire Wound Chip Inductors-----WI Series

Operating Temp. : -40°C~125°C(including self-heating)

### SPECIFICATION TABLE

PART NUMBER 品名	INDUCTANCE (nH) 电感值	Q (min) 品质系数	DCR(max) (Ω) 直流电阻	IDC(max) (mA) 定格电流	SRF(min) (MHz) 自谐频率
WIC1005-1N0K	1.0@250MHz	16	0.045	1360	>6000
WIC1005-2N0K	2.0@250MHz	16	0.070	1040	>6000
WIC1005-2N2K	2.2@250MHz	19	0.070	960	>6000
WIC1005-3N3K	3.3@250MHz	19	0.066	840	6000
WIC1005-3N6K	3.6@250MHz	19	0.066	840	6000
WIC1005-3N9K	3.9@250MHz	19	0.066	840	5800
WIC1005-5N1K	5.1@250MHz	20	0.083	800	5800
WIC1005-5N6K	5.6@250MHz	20	0.083	760	5800
WIC1005-6N2K	6.2@250MHz	20	0.083	760	5800
WIC1005-7N5K	7.5@250MHz	22	0.104	680	5800
WIC1005-8N2K	8.2@250MHz	22	0.104	680	4400
WIC1005-9N0K	9.0@250MHz	22	0.104	680	4160
WIC1005-011K	11@250MHz	24	0.120	640	3680
WIC1005-012K	12@250MHz	24	0.120	640	3600
WIC1005-015K	15@250MHz	24	0.172	560	3280
WIC1005-019K	19@250MHz	24	0.202	480	3040
WIC1005-023K	23@250MHz	24	0.214	400	2720
WIC1005-027K	27@250MHz	24	0.298	400	2480
WIC1005-036K	36@250MHz	24	0.403	320	2320
WIC1005-040K	40@250MHz	24	0.438	320	2240
WIC1608-1N6J	1.6@250MHz	24	0.030	700	12500
WIC1608-1N8J	1.8@250MHz	16	0.045	700	12500
WIC1608-3N6J	3.6@250MHz	22	0.075	700	5900
WIC1608-3N9J	3.9@250MHz	22	0.080	700	6900
WIC1608-4N3J	4.3@250MHz	22	0.075	700	5900
WIC1608-4N7J	4.7@250MHz	20	0.116	700	5800
WIC1608-5N1J	5.1@250MHz	20	0.120	700	5700
WIC1608-6N8J	5.6@250MHz	27	0.110	700	5800
WIC1608-7N5J	6.2@250MHz	28	0.110	700	4800
WIC1608-8N7J	7.5@250MHz	28	0.120	700	4600
WIC1608-9N5J	8.2@250MHz	28	0.135	700	5400
WIC1608-010J	9.0@250MHz	31	0.130	700	4800
WIC1608-011J	11@250MHz	33	0.130	700	4000
WIC1608-012J	12@250MHz	35	0.130	700	4000
WIC1608-015J	15@250MHz	35	0.150	700	4000
WIC1608-016J	16@250MHz	34	0.160	700	3300
WIC1608-018J	18@250MHz	35	0.170	700	3100
WIC1608-022J	22@250MHz	38	0.190	700	3000
WIC1608-024J	24@250MHz	37	0.200	700	2650
WIC1608-027J	27@250MHz	40	0.220	600	2800
WIC1608-030J	30@250MHz	37	0.220	600	2250
WIC1608-033J	33@250MHz	40	0.220	600	2300
WIC1608-036J	36@250MHz	38	0.250	600	2080
WIC1608-039J	39@250MHz	40	0.250	600	2200
WIC1608-043J	43@250MHz	39	0.280	600	2000
WIC1608-047J	47@250MHz	38	0.280	600	2000
WIC1608-056J	56@250MHz	38	0.280	600	1900
WIC1608-068J	68@250MHz	37	0.340	600	1700

## Wire Wound Chip Inductors-----WI Series

Operating Temp. : -40°C~125°C(including self-heating)

PART NUMBER 品名	INDUCTANCE (nH) 电感值	Q (min) 品质系数	DCR(max) (Ω) 直流电阻	IDC(max) (mA) 定格电流	SRF(min) (MHz) 自谐频率
WIC1608-072J	72@250MHz	34	0.380	400	1700
WIC1608-082J	82@250MHz	34	0.480	400	1700
WIC1608-R10J	100@250MHz	34	0.580	400	1400
WIC1608-R11J	110@250MHz	32	0.610	300	1350
WIC1608-R12J	120@250MHz	32	0.650	300	1300
WIC1608-R15J	150@250MHz	28	0.750	280	990
WIC1608-R18J	180@250MHz	25	1.050	240	990
WIC1608-R22J	220@250MHz	25	1.200	200	900
WIC1608-R24J	270@250MHz	24	1.400	170	900
WIC1608-R33J	330@250MHz	24	1.600	160	850
WIC1608-R39J	390@250MHz	24	2.200	150	800
WIC2012-2N2K	2.2@250MHz	50@1500MHz	0.030	800	8500
WIC2012-2N7K	2.7@250MHz	50@1500MHz	0.045	800	8000
WIC2012-3N3K	3.3@250MHz	50@1500MHz	0.090	600	7900
WIC2012-5N6K	5.6@250MHz	65@1000MHz	0.065	600	5500
WIC2012-6N8K	6.8@250MHz	50@1000MHz	0.110	600	5500
WIC2012-8N2K	8.2@250MHz	50@1000MHz	0.120	600	4700
WIC2012-010K	10@250MHz	60@500MHz	0.150	600	4200
WIC2012-012K	12@250MHz	50@500MHz	0.150	600	4000
WIC2012-015K	15@250MHz	50@500MHz	0.170	600	3400
WIC2012-018K	18@250MHz	50@500MHz	0.200	600	3300
WIC2012-022K	22@250MHz	55@500MHz	0.220	500	2600
WIC2012-027K	27@250MHz	55@500MHz	0.250	500	2500
WIC2012-033K	33@250MHz	60@500MHz	0.270	500	2050
WIC2012-039K	39@250MHz	60@500MHz	0.290	500	2000
WIC2012-047K	47@250MHz	60@500MHz	0.310	500	1650
WIC2012-056K	56@250MHz	60@500MHz	0.340	500	1550
WIC2012-062K	62@250MHz	60@500MHz	0.380	500	1500
WIC2012-068K	68@250MHz	60@500MHz	0.380	500	1450
WIC2012-082K	82@250MHz	65@500MHz	0.420	400	1300
WIC2012-R10K	100@250MHz	65@500MHz	0.460	400	1200
WIC2012-R12K	120@250MHz	50@250MHz	0.510	400	1100
WIC2012-R15K	150@250MHz	50@250MHz	0.560	400	920
WIC2012-R18K	180@250MHz	50@250MHz	0.640	400	870
WIC2012-R20K	200@250MHz	50@250MHz	1.000	400	850
WIC2012-R22K	220@250MHz	50@250MHz	1.050	400	850
WIC2012-R27K	270@250MHz	48@250MHz	1.100	350	650
WIC2012-R33K	330@250MHz	48@250MHz	1.400	310	600
WIC2012-R39K	390@250MHz	48@250MHz	1.500	290	560
WIC2012-R47K	470@250MHz	33@100MHz	1.760	250	375
WIC2012-R56K	560@250MHz	23@50MHz	1.900	230	340
WIC2012-R62K	620@250MHz	23@50MHz	2.080	200	320
WIC2012-R68K	680@250MHz	23@50MHz	2.100	190	300
WIC2012-R75K	750@250MHz	23@50MHz	2.120	180	280
WIC2012-R82K	820@250MHz	23@50MHz	2.140	180	250
WIC2012-R91K	910@250MHz	23@50MHz	2.280	180	220
WIC2012-1R0K	1000@250MHz	23@50MHz	2.400	170	200
WIC2012-1R2K	1200@250MHz	22@50MHz	2.55	170	180
WIC2012-1R5K	1500@250MHz	21@50MHz	2.800	160	170
WIC2012-1R8K	1800@250MHz	21@50MHz	3.200	150	160
WIC2012-2R2K	2200@250MHz	21@50MHz	2.800	150	150

## Wire Wound Chip Inductors-----WI Series

Operating Temp. : -40°C~125°C(including self-heating)

PART NUMBER 品名	INDUCTANCE (nH) 电感值	Q (min) 品质系数	DCR(max) (Ω) 直流电阻	IDC(max) (mA) 定格电流	SRF(min) (MHz) 自谐频率
WIC2520-3N9J	3.9@50MHz	50@1500MHz	0.035	1000	6000
WIC2520-4N7J	4.7@50MHz	50@1500MHz	0.045	1000	6000
WIC2520-5N6J	5.6@50MHz	50@1000MHz	0.080	1000	6000
WIC2520-8N2J	8.2@50MHz	50@1000MHz	0.050	1000	5000
WIC2520-010J	10@50MHz	50@500MHz	0.080	1000	4100
WIC2520-012J	12@50MHz	50@500MHz	0.090	1000	3300
WIC2520-015J	15@50MHz	50@500MHz	0.100	1000	2500
WIC2520-018J	18@50MHz	50@350MHz	0.110	1000	2500
WIC2520-022J	22@50MHz	55@350MHz	0.120	1000	2400
WIC2520-027J	27@50MHz	55@350MHz	0.130	1000	1600
WIC2520-033J	33@50MHz	60@350MHz	0.140	1000	1600
WIC2520-039J	39@50MHz	60@350MHz	0.150	1000	1500
WIC2520-047J	47@50MHz	65@350MHz	0.160	1000	1500
WIC2520-056J	56@50MHz	65@350MHz	0.180	1000	1300
WIC2520-062J	62@50MHz	65@350MHz	0.200	1000	1300
WIC2520-068J	68@50MHz	65@350MHz	0.200	1000	1300
WIC2520-075J	75@50MHz	60@350MHz	0.200	1000	1200
WIC2520-082J	82@50MHz	60@350MHz	0.220	1000	1000
WIC2520-R10J	100@25MHz	60@350MHz	0.560	650	1000
WIC2520-R12J	120@25MHz	60@350 MHz	0.630	650	950
WIC2520-R15J	150@25MHz	45@100 MHz	0.700	580	850
WIC2520-R18J	180@25MHz	45@100 MHz	0.770	620	750
WIC2520-R20J	180@25MHz	45@100 MHz	0.800	550	750
WIC2520-R22J	220@25MHz	45@100 MHz	0.840	500	700
WIC2520-R24J	240@25MHz	45@100 MHz	0.880	500	600
WIC2520-R27J	270@25MHz	45@100 MHz	0.910	500	600
WIC2520-R33J	330@25MHz	45@100 MHz	1.050	450	570
WIC2520-R39J	390@25MHz	45@100 MHz	1.120	470	500
WIC2520-R47J	470@25MHz	45@100 MHz	1.190	470	450
WIC2520-R56J	560@25MHz	45@100 MHz	1.330	400	415
WIC2520-R62J	620@25MHz	45@100 MHz	1.400	400	375
WIC2520-R68J	680@25MHz	45@100 MHz	1.470	400	375
WIC2520-R75J	750@25MHz	45@100 MHz	1.540	360	360
WIC2520-R82J	820@25MHz	45@100 MHz	1.610	400	350
WIC2520-R91J	910@25MHz	35@50 MHz	1.680	380	320
WIC2520-1R0J	1000@25MHz	35@50 MHz	1.750	370	290
WIC2520-1R2J	1200@25MHz	35@50 MHz	2.000	310	250
WIC2520-1R5J	1500@7.9MHz	28@50 MHz	2.300	330	200
WIC2520-1R8J	1800@7.9MHz	28@50 MHz	2.600	300	160
WIC2520-2R2J	2200@7.9MHz	28@50 MHz	2.800	280	160
WIC2520-2R7J	2700@7.9MHz	22@25 MHz	3.200	290	140
WIC2520-3R3J	3300@7.9MHz	22@25 MHz	3.400	290	110
WIC2520-3R9J	3900@7.9MHz	20@25 MHz	3.600	260	100
WIC2520-4R7J	4700@7.9MHz	20@25 MHz	4.000	260	90
WIC2520-5R6J	5600@7.9MHz	20@7.9 MHz	7.600	240	60
WIC2520-6R8J	6800@7.9MHz	20@7.9 MHz	8.200	200	60

## Wire Wound Chip Inductors-----WI Series

Operating Temp. : -40°C~125°C(including self-heating)

PART NUMBER 品名	INDUCTANCE (nH) 电感值	Q (min) 品质系数	DCR(max) (Ω) 直流电阻	IDC(max) (mA) 定格电流	SRF(min) (MHz) 自谐频率
WIC3225-3N9J	3.9@100MHz	30@300MHz	0.050	1000	6000
WIC3225-4N7J	4.7@100MHz	30@300MHz	0.065	1000	5800
WIC3225-8N2J	8.2@100MHz	30@300MHz	0.070	1000	5500
WIC3225-010J	10@100MHz	40@300MHz	0.080	1000	4000
WIC3225-012J	12@100MHz	40@300MHz	0.080	1000	3200
WIC3225-015J	15@100MHz	40@300MHz	0.100	1000	3200
WIC3225-018J	18@100MHz	50@300	0.100	1000	2800
WIC3225-022J	22@100MHz	50@300	0.100	1000	2200
WIC3225-027J	27@100MHz	50@300	0.110	1000	1800
WIC3225-033J	33@100MHz	55@300	0.110	1000	1800
WIC3225-039J	39@100MHz	55@300	0.120	1000	1800
WIC3225-043J	43@100MHz	55@300	0.120	1000	1500
WIC3225-047J	47@100MHz	55@300	0.130	1000	1500
WIC3225-056J	56@100MHz	55@300	0.140	1000	1450
WIC3225-068J	68@100MHz	55@300	0.150	900	1200
WIC3225-082J	82@100MHz	55@300	0.200	900	1200
WIC3225-R10J	100@100MHz	55@300	0.210	850	1100
WIC3225-R12J	120@100MHz	60@300	0.210	800	1100
WIC3225-R15J	150@100MHz	60@300	0.250	750	950
WIC3225-R18J	180@50MHz	60@300	0.300	700	900
WIC3225-R22J	220@50MHz	60@300	0.320	670	760
WIC3225-R27J	270@50MHz	55@300	0.340	630	730
WIC3225-R33J	330@50MHz	45@150	0.380	590	650
WIC3225-R39J	390@50MHz	45@150	0.580	530	600
WIC3225-R47J	470@50MHz	45@150	0.800	490	550
WIC3225-R56J	560@35MHz	45@150	1.100	460	470
WIC3225-R68J	680@35MHz	45@150	1.200	430	450
WIC3225-R82J	820@35MHz	45@150	1.820	400	420
WIC3225-1R0J	1000@35MHz	45@150	1.850	320	400
WIC3225-1R2J	1200@35MHz	45@150	1.870	300	380
WIC3225-1R5J	1500@7.9MHz	30@50	1.950	310	160
WIC3225-1R8J	1800@7.9MHz	30@50	2.250	310	160
WIC3225-2R2J	2200@7.9MHz	30@50	2.410	310	160
WIC3225-2R7J	2700@7.9MHz	28@25	2.850	300	140
WIC3225-3R3J	3300@7.9MHz	25@25	3.120	300	110
WIC3225-3R9J	3900@7.9MHz	25@25	3.600	290	100
WIC3225-4R7J	4700@7.9MHz	25@25	4.000	280	75
WIC3225-5R6J	5600@7.9MHz	20@7.9	5.000	250	70
WIC3225-6R8J	6800@7.9MHz	20@7.9	8.000	230	70
WIC3225-8R6J	8600@7.9MHz	20@7.9	9.000	160	55

## Wire Wound Chip Inductors-----WI Series

Operating Temp. : -40°C~125°C(including self-heating )

PART NUMBER 品名	INDUCTANCE (nH) 电感值	Q (min) 品质系数	TESTING FREQ.(MHz) 测试频率	DCR(max) (Ω) 直流电阻	IDC(max) (mA) 定格电流	SRF(min) (MHz) 自谐频率
WIF2012-1R2K	1.2	23	7.96	1.05	600	350
WIF2012-1R5K	1.5	23	7.96	1.20	580	300
WIF2012-1R8K	1.8	23	7.96	1.35	550	260
WIF2012-2R2K	2.2	20	7.96	1.50	510	210
WIF2012-2R7K	2.7	20	7.96	1.70	460	160
WIF2012-3R3K	3.3	20	7.96	1.80	430	130
WIF2012-3R9K	3.9	20	7.96	1.95	400	115
WIF2012-4R7K	4.7	20	7.96	2.05	370	105
WIF2012-5R6K	5.6	20	7.96	2.30	360	90
WIF2012-6R8K	6.8	20	7.96	2.60	330	85
WIF2520-1R2K	1.2	20	7.96	0.75	550	250
WIF2520-1R5K	1.5	20	7.96	0.80	400	230
WIF2520-1R8K	1.8	20	7.96	0.95	320	168
WIF2520-2R2K	2.2	20	7.96	1.30	315	150
WIF2520-2R7K	2.7	20	7.96	1.40	300	125
WIF2520-3R3K	3.3	20	7.96	1.50	280	110
WIF2520-3R9K	3.9	20	7.96	1.55	250	90
WIF2520-4R7K	4.7	20	7.96	1.75	210	76
WIF2520-5R6K	5.6	18	7.96	1.90	190	76
WIF2520-6R8K	6.8	18	7.96	2.00	175	51
WIF2520-8R2K	8.2	18	7.96	2.20	160	34
WIF2520-100K	10	18	2.52	2.50	155	34
WIF2520-150K	15	18	2.52	3.00	130	23
WIF2520-220K	22	18	2.52	3.90	105	23
WIF2520-330K	33	15	2.52	4.80	85	10
WIF2520-470K	47	15	2.52	5.70	60	8.5
WIF2520-680K	68	15	2.52	6.70	50	7.1
WIF2520-101K	100	10	2.52	11.0	40	4.8
WIF3225-1R2K	1.2	28	7.96	0.3	210	450
WIF3225-1R5K	1.5	28	7.96	0.4	200	450
WIF3225-1R8K	1.8	28	7.96	0.5	195	450
WIF3225-2R2K	2.2	28	7.96	0.6	175	450
WIF3225-2R7K	2.7	28	7.96	0.7	160	420
WIF3225-3R3K	3.3	28	7.96	1.1	120	380
WIF3225-3R9K	3.9	28	7.96	1.2	110	360
WIF3225-4R7K	4.7	28	7.96	1.3	105	350
WIF3225-5R6K	5.6	28	7.96	2.0	100	320
WIF3225-6R8K	6.8	28	7.96	1.5	80	310
WIF3225-8R2K	8.2	28	7.96	1.6	75	305
WIF3225-100K	10	25	2.52	1.0	70	300
WIF3225-120K	12	25	2.52	1.2	65	265
WIF3225-150K	15	25	2.52	2.0	60	225
WIF3225-180K	18	25	2.52	2.1	45	210
WIF3225-220K	22	25	2.52	2.2	35	200
WIF3225-270K	27	25	2.52	2.6	30	180
WIF3225-330K	33	25	2.52	2.9	23	160
WIF3225-390K	39	25	2.52	3.7	21	150
WIF3225-470K	47	25	2.52	4.8	20	140
WIF3225-560K	56	25	2.52	5.1	15	125
WIF3225-680K	68	25	2.52	4.7	15	110

## Wire Wound Chip Inductors-----WI Series

Operating Temp. : -40°C~125°C(including self-heating )

PART NUMBER 品名	INDUCTANCE (nH) 电感值	Q (min) 品质系数	TESTING FREQ.(MHz) 测试频率	DCR(max) (Ω) 直流电阻	IDC(max) (mA) 定格电流	SRF(min) (MHz) 自谐频率
WIF3225-820K	82	25	2.52	5.6	13	100
WIF3225-101K	100	15	0.796	6.5	6.0	95
WIF3225-121K	120	15	0.796	7.1	5.0	85
WIF3225-151K	150	15	0.796	8.2	4.5	80
WIF3225-181K	180	15	0.796	12.5	3.0	70
WIF3225-221K	220	15	0.796	15.3	3.0	65
WIF3225-271K	270	15	0.796	16.4	2.5	60
WIF3225-331K	330	15	0.796	17.8	2.3	55
WIF3225-391K	390	10	0.796	19.5	2.2	45
WIF3225-471K	470	10	0.796	21.0	2.0	40
WIF4532-1R0K	1.0	30	7.96	0.20	1000	200
WIF4532-1R2K	1.2	30	7.96	0.21	1000	200
WIF4532-1R5K	1.5	30	7.96	0.22	1000	180
WIF4532-1R8K	1.8	35	7.96	0.24	950	160
WIF4532-2R2K	2.2	35	7.96	0.25	900	150
WIF4532-2R7K	2.7	35	7.96	0.30	850	145
WIF4532-3R3K	3.3	35	7.96	0.32	800	140
WIF4532-3R9K	3.9	35	7.96	0.40	750	135
WIF4532-4R7K	4.7	35	7.96	0.50	700	120
WIF4532-5R6K	5.6	35	7.96	0.55	650	110
WIF4532-6R8K	6.8	35	7.96	0.80	600	98
WIF4532-8R2K	8.2	35	7.96	0.85	600	95
WIF4532-100K	10	30	2.52	1.0	550	75
WIF4532-120K	12	30	2.52	1.1	550	70
WIF4532-150K	15	30	2.52	1.2	500	60
WIF4532-180K	18	30	2.52	1.2	500	29
WIF4532-220K	22	30	2.52	1.3	450	25
WIF4532-270K	27	28	2.52	1.5	400	22
WIF4532-330K	33	28	2.52	1.7	350	18
WIF4532-390K	39	28	2.52	1.8	350	14
WIF4532-470K	47	28	2.52	2.0	300	14
WIF4532-560K	56	25	2.52	2.2	290	14
WIF4532-680K	68	20	2.52	2.4	260	5.4
WIF4532-820K	82	20	2.52	2.8	240	5.4
WIF4532-101K	100	20	0.796	3.0	220	4.2
WIF4532-121K	120	20	0.796	3.3	220	3.3
WIF4532-151K	150	20	0.796	3.7	200	3.0
WIF4532-181K	180	20	0.796	4.0	200	3.0
WIF4532-221K	220	15	0.796	7.0	170	2.5
WIF4532-271K	270	15	0.796	7.6	160	2.5
WIF4532-331K	330	15	0.796	8.5	150	2.0
WIF4532-391K	390	15	0.796	9.2	130	2.0
WIF4532-471K	470	10	0.796	10.4	120	2.0
WIF4532-561K	560	10	0.796	12.0	110	2.0
WIF4532-681K	680	10	0.796	14.0	100	1.8
WIF4532-821K	820	10	0.796	15.0	95	1.6
WIF4532-102K	1000	10	0.252	16.5	90	1.6



## X-ON Electronics

Largest Supplier of Electrical and Electronic Components

*Click to view similar products for [Fixed Inductors](#) category:*

*Click to view products by [Ceaiya](#) manufacturer:*

Other Similar products are found below :

[MLZ1608M6R8WTD25](#) [MLZ1608N6R8LT000](#) [MLZ1608N3R3LTD25](#) [MLZ1608N3R3LT000](#) [MLZ1608N150LT000](#)  
[MLZ1608M150WTD25](#) [MLZ1608M3R3WTD25](#) [MLZ1608M3R3WT000](#) [MLZ1608M150WT000](#) [MLZ1608A1R5WT000](#)  
[MLZ1608N1R5LT000](#) [B82432C1333K000](#) [PCMB053T-1R0MS](#) [PCMB053T-1R5MS](#) [PCMB104T-1R5MS](#) [CR32NP-100KC](#) [CR32NP-151KC](#) [CR32NP-180KC](#) [CR32NP-181KC](#) [CR32NP-1R5MC](#) [CR32NP-390KC](#) [CR32NP-3R9MC](#) [CR32NP-680KC](#) [CR32NP-820KC](#)  
[CR32NP-8R2MC](#) [CR43NP-390KC](#) [CR43NP-560KC](#) [CR43NP-680KC](#) [CR54NP-181KC](#) [CR54NP-470LC](#) [CR54NP-820KC](#) [CR54NP-8R5MC](#)  
[MGDQ4-00004-P](#) [MGDU1-00016-P](#) [MHL1ECTTP18NJ](#) [MHL1JCTTD12NJ](#) [PE-51506NL](#) [PE-53601NL](#) [PE-53630NL](#) [PE-53824SNLT](#) [PE-62892NL](#) [PE-92100NL](#) [PG0434.801NLT](#) [PG0936.113NLT](#) [PM06-2N7](#) [PM06-39NJ](#) [HC2LP-R47-R](#) [HC2-R47-R](#) [HC3-2R2-R](#) [HC8-1R2-R](#)