

Specification Sheet for Approved

| | |
|--------------------|---------------|
| Customer Name: | |
| Customer Part No.: | |
| Ceaiya Part No: | CR6020 Series |
| Spec No: | L002-1 |

【For Customer Approval Only】

If you Approval, Please Stamp

【RoHS Compliant Parts】

| Approved By | Checked By | Prepared By |
|-------------|------------|-------------|
| 李庆辉 | 刘志坚 | 劳水花 |

Shenzhen Ceaiya Electronics Co., Ltd.

地址 1: 深圳市龙华区观湖街道鹭湖社区观盛二路 5 号捷顺科技中心 B706

地址 2: 广东省东莞清溪镇青滨东路 105 号力合紫荆智能制造中心 10 栋

Http://www.szceaiya.com

Tel: 0769-89135516

Fax: 0769-89135519

【Version of Changed Record】

| Rev. | Effective Date | Changed Contents | Change Reasons | Approved By |
|------|----------------|------------------|----------------|-------------|
| A0 | 2023.05.25 | New release | / | Li qing hui |
| | | | | |

1. Shape and Dimension (Unit:mm)

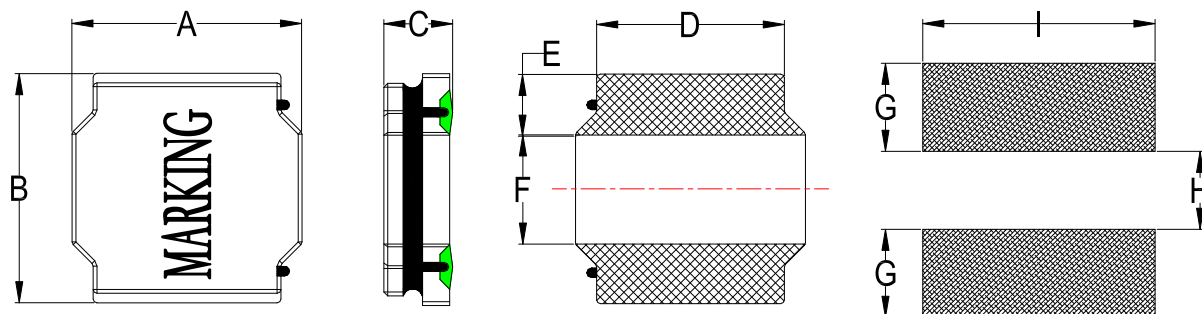

| A | B | C | D | E | F | G | H | I |
|-----------|-----------|--------|---------|----------|---------|--------|--------|--------|
| 6.0 ± 0.3 | 6.0 ± 0.3 | 2.0Max | 4.9±0.3 | 1.55±0.3 | 2.9±0.3 | 1.7Ref | 2.8Ref | 5.7Ref |

注：喷码尺寸长 3.6±0.5mm, 宽 2.5±0.5mm

2. Electronic Characteristics List

| Part Number | Inductance (uH) | Tolerance (±%) | DCR(mΩ) ±30% | Isat (A) | Irise (A) | Test Condition | Marking |
|-------------|--------------------|-------------------|-----------------|-------------|--------------|-------------------|---------|
| CR6020-R68N | 0.68 | 30 | 15 | 7.50 | 3.80 | 100KHz /0.25V | R68 |
| CR6020-1R0N | 1.0 | 30 | 20 | 4.80 | 3.50 | 100KHz /0.25V | 1R0 |
| CR6020-1R2N | 1.2 | 30 | 20 | 4.30 | 3.50 | 100KHz /0.25V | 1R2 |
| CR6020-1R5N | 1.5 | 30 | 25 | 4.30 | 3.20 | 100KHz /0.25V | 1R5 |
| CR6020-2R2N | 2.2 | 30 | 35 | 3.75 | 2.75 | 100KHz /0.25V | 2R2 |
| CR6020-3R3N | 3.3 | 30 | 45 | 3.15 | 2.60 | 100KHz /0.25V | 3R3 |
| CR6020-4R7N | 4.7 | 30 | 58 | 3.00 | 2.00 | 100KHz /0.25V | 4R7 |
| CR6020-5R6M | 5.6 | 20 | 70 | 2.40 | 1.90 | 100KHz /0.25V | 5R6 |
| CR6020-6R8M | 6.8 | 20 | 85 | 2.20 | 1.80 | 100KHz /0.25V | 6R8 |
| CR6020-100M | 10 | 20 | 120 | 1.75 | 1.40 | 100KHz /0.25V | 100 |
| CR6020-150M | 15 | 20 | 160 | 1.50 | 1.20 | 100KHz /0.25V | 150 |
| CR6020-220M | 22 | 20 | 240 | 1.25 | 1.00 | 100KHz /0.25V | 220 |
| CR6020-270M | 27 | 20 | 350 | 1.15 | 0.95 | 100KHz /0.25V | 270 |
| CR6020-330M | 33 | 20 | 400 | 1.10 | 0.90 | 100KHz /0.25V | 330 |
| CR6020-470M | 47 | 20 | 500 | 1.00 | 0.80 | 100KHz /0.25V | 470 |
| CR6020-680M | 68 | 20 | 815 | 0.80 | 0.68 | 100KHz /0.25V | 680 |

※ All test data is referenced to 25°C ambient;

Isat : DC Saturation Current that will cause initial inductance to drop approximately 30% max.

Irise : DC Current that will cause an approximate ΔT of 40 °C

Measuring Instrument :

L:HIOKI3532-50

DCR:HIOKI 3540

Isat / Irise: HP4284+42841A

3. General Characteristics

3-1. Storage Temperature range : $-40^{\circ}\text{C} \sim +105^{\circ}\text{C}$

3-2. Operating temperature range: $-40^{\circ}\text{C} \sim +125^{\circ}\text{C}$ (Including coil's self temperature rise)

3-3. External appearance : No external defects can be found in the visual inspection.

3-4. Electrode strength : No electrode detachment should be found when the device is pushed in two directions of X and Y with the force of 10.0N for 60 ± 2 seconds after soldering between copper plate and the electrodes.
(Refer to figure at right)

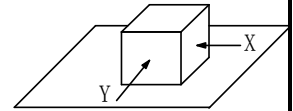

3-5. Vibration test : Inductance deviation is within $\pm 10.0\%$ after 1 hour sweeping vibration in each three directions, namely, forward and backward, up and down, right and left. The frequency is $10 \sim 55 \sim 10\text{Hz}$ and the amplitude of 1 minute cycle is 1.5mm PP.

3-6. Recommended reflow condition:

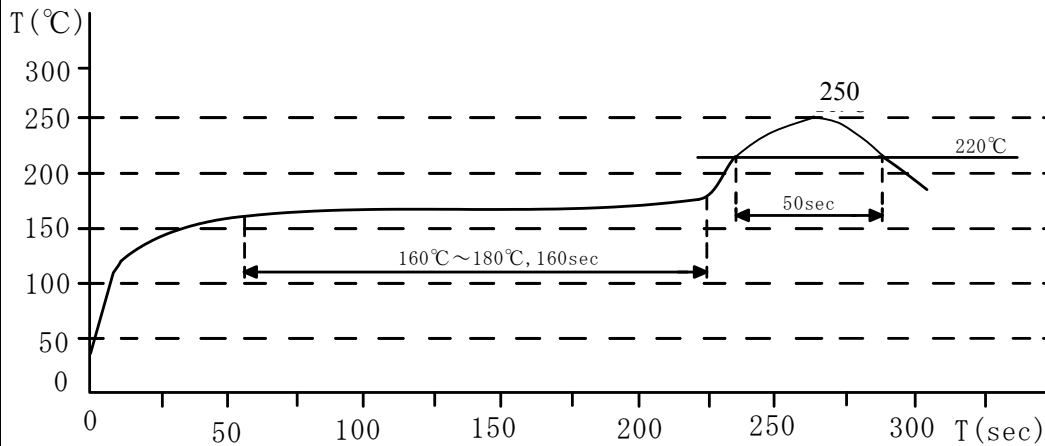

3-7. Humidity test : Inductance deviation is within $\pm 5.0\%$ after 96 ± 4 hours test under the condition of relative humidity of $90 \sim 95\%$ and temperature of $60 \pm 2^{\circ}\text{C}$, and 1 hour storage under room ambient conditions after the device is wiped with dry cloth.

LEAD-FREE



4. Construction and materials

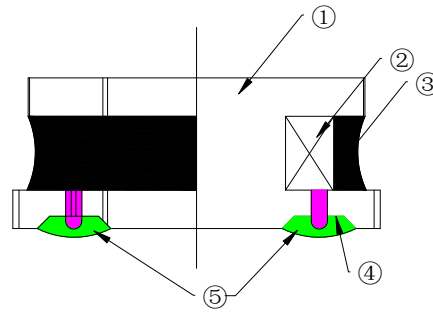

| No. | Part name | Material | Ceaiya P/N |
|-----|--------------------|---|------------|
| ① | Drum Core | Ni-Zn Ferrite Core | TW/CY |
| ② | Wire | Polyurethane enameled copper wire | YLSL |
| ③ | Adhesive | Epoxy Resin Magnetic Powder | |
| ④ | Plating Electrodes | Plating: Ag 3-7 μ m Ni 1-3 μ m Sn 3-7 μ m | |
| ⑤ | Outer Electrodes | Top surface solder coating Sn99%、 Ag0.3%、Cu0.7% | YX |

5. Package Specification

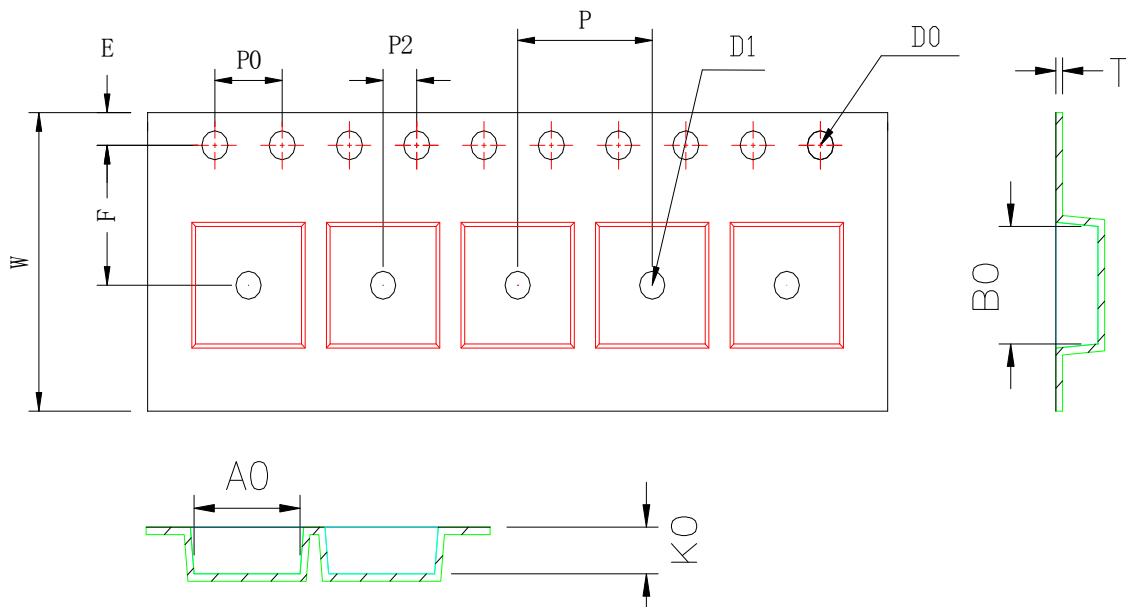

| ITEM | W | A0 | B1 | K0 | P | F | E | D0 | D1 | P0 | P2 | T |
|------|-----------|-----------|-----------|-----------|-----------|------------|-----------|------|------|-----------|-----------|------------|
| DIM | 12.00 | 6.3 | 6.3 | 2.5 | 8.00 | 5.50 | 1.75 | 1.50 | 1.50 | 4.00 | 2.00 | 0.35 |
| TOLE | ± 0.3 | ± 0.1 | ± 0.1 | ± 0.1 | ± 0.1 | ± 0.15 | ± 0.1 | +0.1 | +0.1 | ± 0.1 | ± 0.1 | ± 0.05 |

6. CARRIER REEL DIMENSIONS:

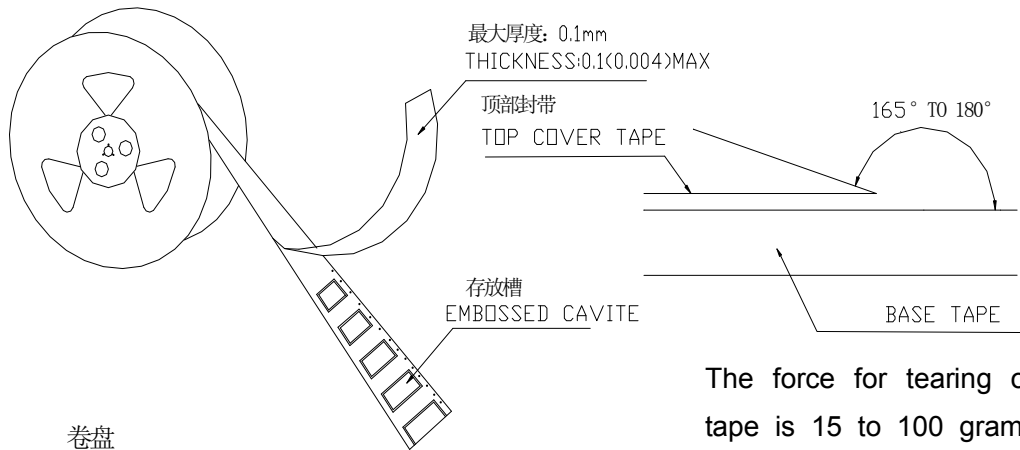

卷盘
Carrier Tape Reel

The force for tearing off cover tape is 15 to 100 grams in the arrow direction/按箭头的方向施加 15 克至 100 克力撕开

材质: 纸/塑胶

MATERIAL: PAPER/PLASTIC

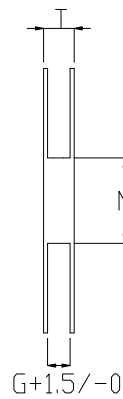
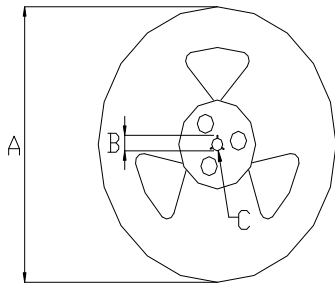

Unit: mm



| Type | A | B | C | G | N | T |
|------|-----|--------|--------|------|-----|------|
| 12mm | 330 | 21±0.8 | 13±0.4 | 12.4 | 100 | 16.4 |

7. PACKAGE SPECIFICATION :

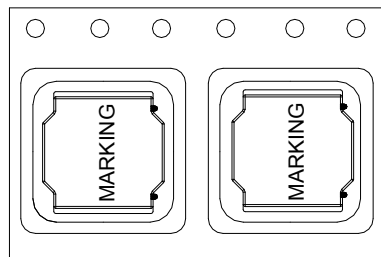
3KPCS/Reel 9KPCS/Inner Box 27KPCS/Outer Box

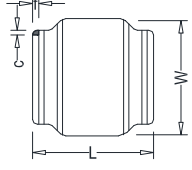
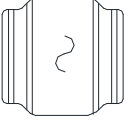
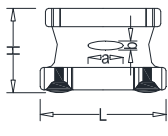

Visual Inspection Standard of Product

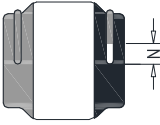
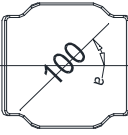
| No. | Defect Item | Figure | Rejection Identification | Acceptance |
|-----|----------------|---|---|------------|
| 1 | Core Defect |  | The defect length(c or f)more than L/6 or W/6 , NG | AQL=0.65 |
| 2 | Core Crack |  | Visual cracks , NG | AQL=0.65 |
| 3 | Starvation |  | (1)Resin starved length a more than L/2, NG (2)When $L > 2\text{mm}$, $b > H/2$, NG (3)When $L \leq 2\text{mm}$, b don't control | AQL=0.65 |
| 4 | Excessive glue |  | The length, width or height of product beyond specified value, NG | AQL=0.65 |
| 5 | Cold Solder |  | (1)For CR2520** Series , cold solder $N > 0.5\text{mm}$,NG (2)For other series, cold solder $N > 1\text{mm}$,NG | AQL=0.65 |
| 6 | Marking Defect |  | The marking angle $a > 45^\circ$, NG | AQL=0.65 |



Δf : Clearance between terminal and the surface of plate must be 0.2mm max when coil is placed on a flat plate.

X-ON Electronics

Largest Supplier of Electrical and Electronic Components

Click to view similar products for [Fixed Inductors](#) category:

Click to view products by [Ceaiya](#) manufacturer:

Other Similar products are found below :

[CR32NP-100KC](#) [CR54NP-470LC](#) [70F224AI](#) [MGDQ4-00004-P](#) [MHQ1005P10NJ](#) [MHQ1005P1N0S](#) [MHQ1005P2N4S](#) [MHQ1005P3N6S](#)
[MHQ1005P5N1S](#) [MHQ1005P8N2J](#) [PE-53601NL](#) [PE-53602NL](#) [PG0936.113NLT](#) [9220-20](#) [9310-16](#) [PM06-2N7](#) [PM06-39NJ](#) [A01TK](#)
[1206CS-471XJ](#) [HC2-R47-R](#) [HC8-1R2-R](#) [HCF1305-3R3-R](#) [1206CS-151XG](#) [RCH664NP-140L](#) [RCH664NP-4R7M](#) [RCP1317NP-391L](#)
[RCR110DNP-331L](#) [DH2280-4R7M](#) [DS1608C-106](#) [B10TJ](#) [B82498B3101J000](#) [ELJ-RE27NJF2](#) [1812CS-153XJ](#) [1812CS-183XJ](#) [1812CS-](#)
[223XJ](#) [1812LS-104XJ](#) [1812LS-105XJ](#) [1812LS-124XJ](#) [1812LS-154XJ](#) [1812LS-223XJ](#) [1812LS-224XJ](#) [1812LS-563XJ](#) [1812LS-683XJ](#)
[1812LS-824XJ](#) [NIN-FB101JTR110F](#) [NIN-FB471JTR62F](#) [NIN-FC1R5JTR220F](#) [NIN-HCR15JTRF](#) [NIN-HCR33JTRF](#) [NIN-HDR22JTRF](#)