

# Specification Sheet for Approved

Customer Name:	
Customer Part No.:	
Ceaiya Part No:	CR6028 Series
Spec No:	L001-1

## 【For Customer Approval Only】

If you Approval, Please Stamp

## 【RoHS Compliant Parts】

Approved By	Checked By	Prepared By
李庆辉	刘志坚	劳水花

## Shenzhen Ceaiya Electronics Co., Ltd.

地址 1: 深圳市龙华区观湖街道鹭湖社区观盛二路 5 号捷顺科技中心 B706

地址 2: 广东省东莞清溪镇青滨东路 105 号力合紫荆智能制造中心 10 栋

Http://www.szceaiya.com    Tel: 0769-89135516    Fax: 0769-89135519

**【Version of Changed Record】**

Rev.	Effective Date	Changed Contents	Change Reasons	Approved By
A0	2023.05.25	New release	/	Li qing hui

## 1. Shape and Dimension ( Unit:mm )

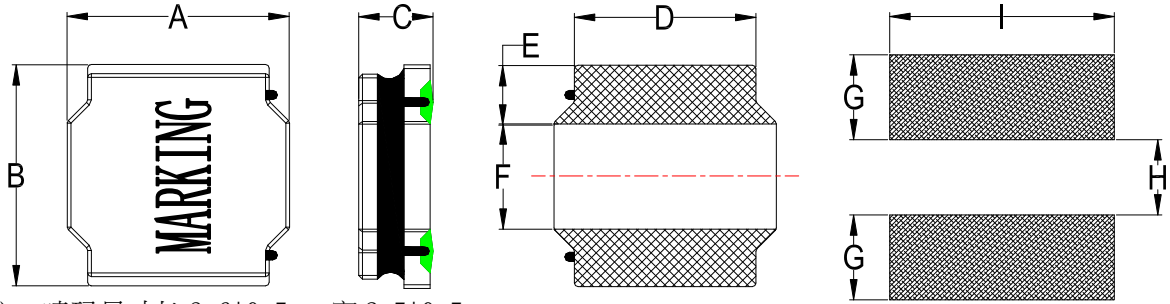

注：喷码尺寸长 3.6±0.5mm, 宽 2.5±0.5mm

A	B	C	D	E	F	G	H	I
6.0 ± 0.3	6.0 ± 0.3	2.8Max	4.9±0.3	1.55±0.3	2.9±0.3	1.7Ref	2.8 Ref	5.7 Ref

## 2. Electronic Characteristics List

Part Number	Inductance (uH)	Tolerance (±%)	DCR(mΩ) ±30%	Isat (A)	Irise (A)	Test Condition	Marking
CR6028-1R0N	1.0	30	12	6.70	4.60	100KHz /0.25V	1R0
CR6028-1R2N	1.2	30	16	6.50	4.30	100KHz /0.25V	1R2
CR6028-1R5N/M	1.5	30,20	16	6.00	4.30	100KHz /0.25V	1R5
CR6028-1R8N	1.8	30	19	5.30	4.10	100KHz /0.25V	1R8
CR6028-2R2N/M	2.2	30,20	20	5.10	3.75	100KHz /0.25V	2R2
CR6028-3R3N/M	3.3	30,20	25	3.63	3.40	100KHz /0.25V	3R3
CR6028-4R7N/M	4.7	30,20	33	3.00	3.00	100KHz /0.25V	4R7
CR6028-5R6N	5.6	30	45	2.80	2.45	100KHz /0.25V	5R6
CR6028-6R8M	6.8	20	56	2.60	2.40	100KHz /0.25V	6R8
CR6028-8R2M	8.2	20	68	2.40	2.25	100KHz /0.25V	8R2
CR6028-100M	10	20	78	2.05	1.90	100KHz /0.25V	100
CR6028-120M	12	20	88	1.80	1.70	100KHz /0.25V	120
CR6028-150M	15	20	125	1.75	1.50	100KHz /0.25V	150
CR6028-180M	18	20	130	1.55	1.45	100KHz /0.25V	180
CR6028-220M	22	20	140	1.45	1.40	100KHz /0.25V	220
CR6028-270M	27	20	180	1.40	1.30	100KHz /0.25V	270
CR6028-330M	33	20	220	1.35	1.10	100KHz /0.25V	330
CR6028-390M	39	20	225	1.25	1.10	100KHz /0.25V	390
CR6028-470M	47	20	280	1.15	1.05	100KHz /0.25V	470
CR6028-560M	56	20	350	1.05	0.89	100KHz /0.25V	560
CR6028-680M	68	20	420	0.95	0.85	100KHz /0.25V	680
CR6028-820M	82	20	550	0.80	0.70	100KHz /0.25V	820
CR6028-101M	100	20	670	0.65	0.60	100KHz /0.25V	101
CR6028-121M	120	20	820	0.62	0.58	100KHz /0.25V	121

※ All test data is referenced to 25°C ambient;

**Isat** : DC Saturation Current that will cause initial inductance to drop approximately 30% max.

**Irise** : DC Current that will cause an approximate ΔT of 40 °C

**Measuring Instrument :**

L:HIOKI3532-50

DCR:HIOKI 3540

Isat / Irise: 6377&6220Microtest

### 3. General Characteristics

3-1. Storage Temperature range :  $-40^{\circ}\text{C} \sim +125^{\circ}\text{C}$

3-2. Operating temperature range:  $-40^{\circ}\text{C} \sim +125^{\circ}\text{C}$  (Including coil's self temperature rise)

3-3. External appearance : No external defects can be found in the visual inspection.

3-4. Electrode strength : No electrode detachment should be found when the device is pushed in two directions of X and Y with the force of 10.0N for  $60 \pm 2$  seconds after soldering between copper plate and the electrodes.  
(Refer to figure at right)

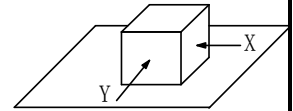

3-5. Vibration test : Inductance deviation is within  $\pm 10.0\%$  after 1 hour sweeping vibration in each three directions, namely, forward and backward, up and down, right and left. The frequency is  $10 \sim 55 \sim 10\text{Hz}$  and the amplitude of 1 minute cycle is 1.5mm PP.

3-6. Recommended reflow condition:

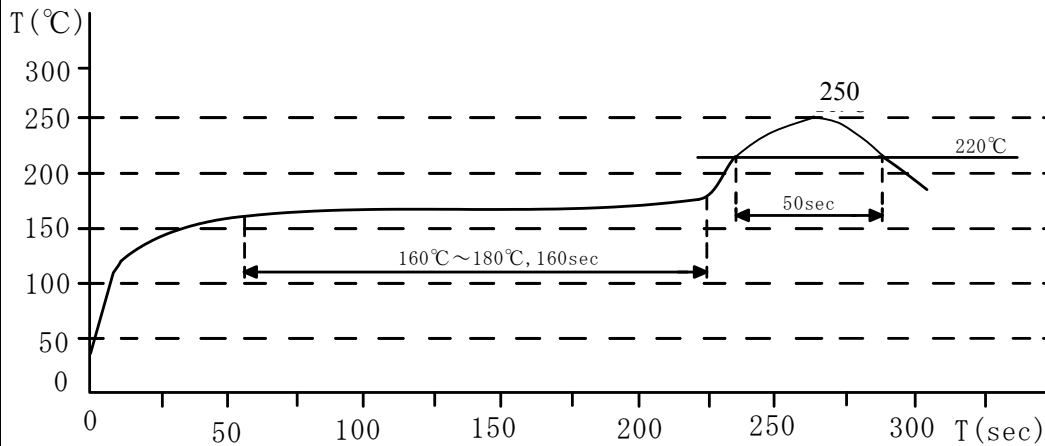

3-7. Humidity test : Inductance deviation is within  $\pm 5.0\%$  after  $96 \pm 4$  hours test under the condition of relative humidity of  $90 \sim 95\%$  and temperature of  $60 \pm 2^{\circ}\text{C}$ , and 1 hour storage under room ambient conditions after the device is wiped with dry cloth.

**LEAD-FREE**

**RoHS**  
Compliance

#### 4. Construction and materials

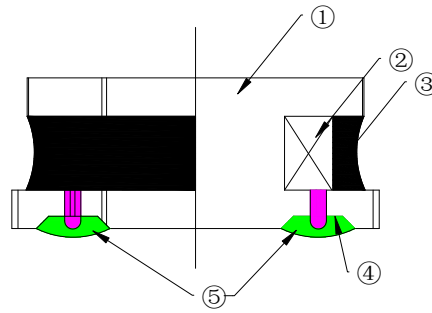

No.	Part name	Material	Ceaiya P/N
①	Drum Core	Ni-Zn Ferrite Core	TW/CY
②	Wire	Polyurethane enameled copper wire	YLSL
③	Adhesive	Epoxy Resin Magnetic Powder	
④	Plating Electrodes	Plating: Ag 3-7 $\mu\text{m}$ Ni 1-3 $\mu\text{m}$ Sn 3-7 $\mu\text{m}$	
⑤	Outer Electrodes	Top surface solder coating Sn99%、 Ag0.3%、Cu0.7%	YX

#### 5. Package Specification

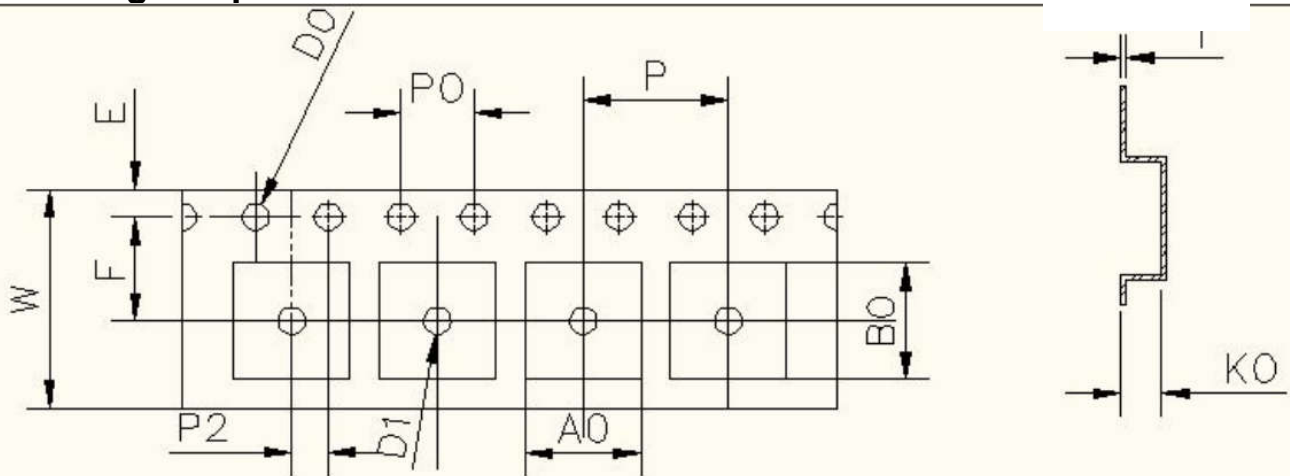

ITEM	W	A0	B0	K0	P	F	E	D0	D1	P0	P2	T
DIM	12.00	6.4	6.3	3.15	8.00	5.50	1.75	1.50	1.50	4.00	2.00	0.35
TOLE	$\pm 0.3$	$\pm 0.1$	$\pm 0.1$	$\pm 0.1$	$\pm 0.1$	$\pm 0.15$	$\pm 0.1$	+0.1	+0.1	$\pm 0.1$	$\pm 0.1$	$\pm 0.05$

## 6. CARRIER REEL DIMENSIONS:

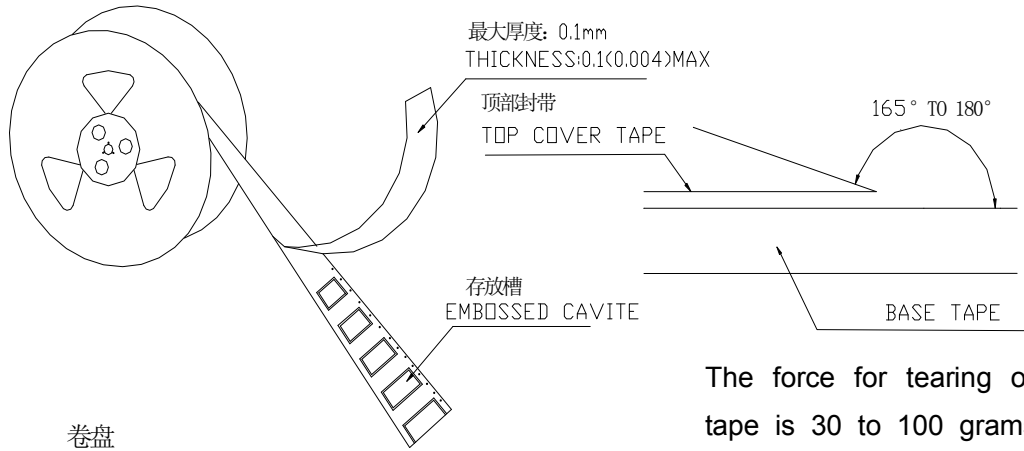

卷盘  
Carrier Tape Reel

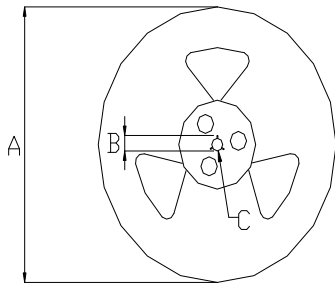

The force for tearing off cover tape is 30 to 100 grams in the arrow direction/按箭头的方向施加 30 克至 100 克力撕开

材质: 塑胶  
MATERIAL: PLASTIC

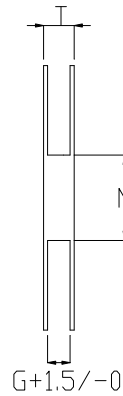

Unit: mm

Type	A	B	C	G	N	T
12mm	330	21±0.8	13±0.4	12.4	100	16.4

## 7. PACKAGE SPECIFICATION :

2KPCS/Reel    6KPCS/Inner Box    18KPCS/Outer Box

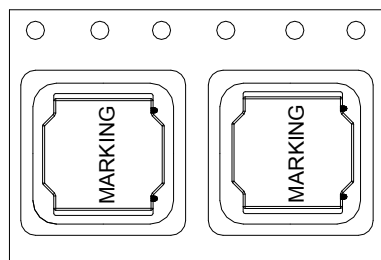

## 8. PACK :

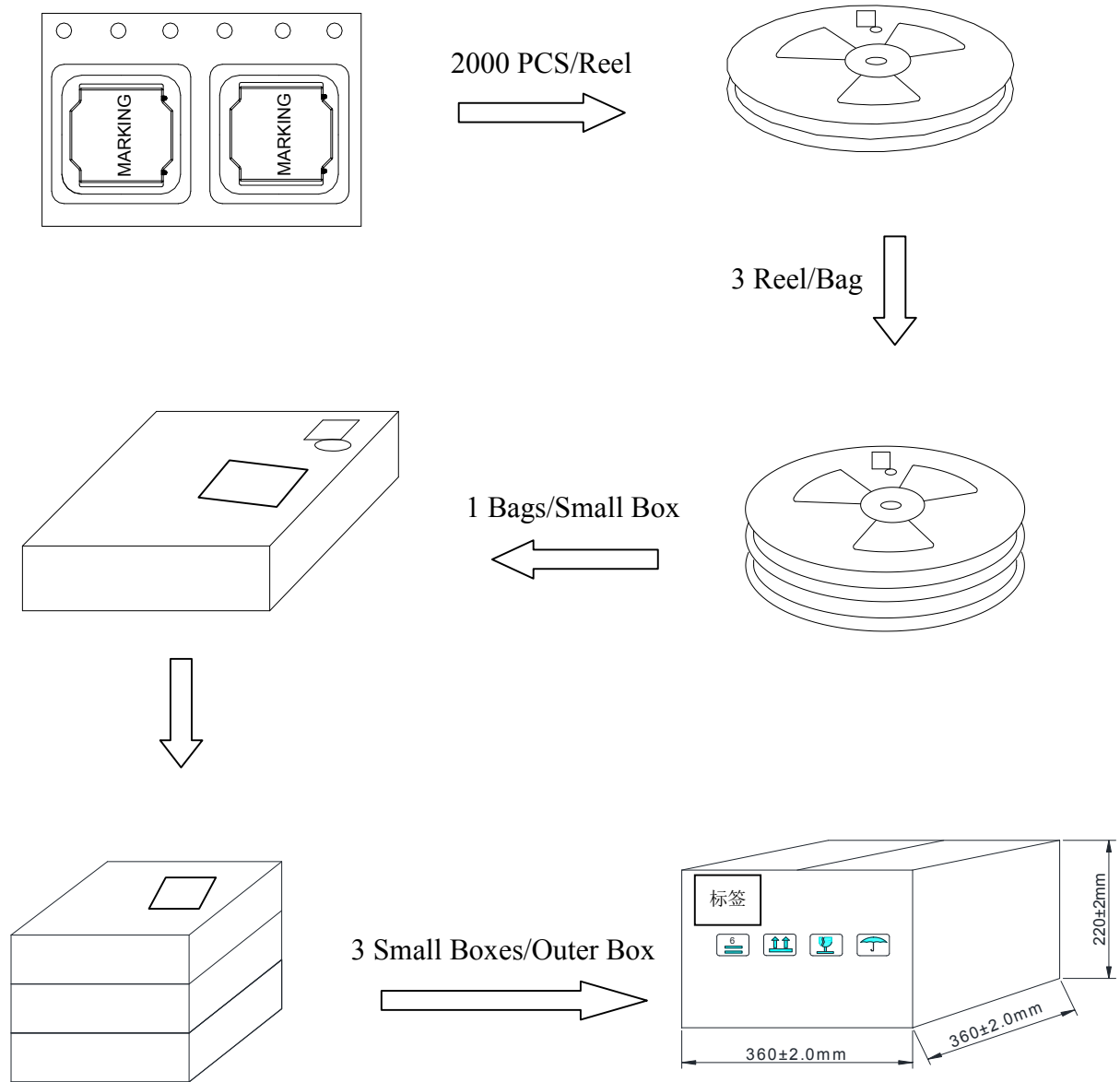

内箱规格: 350\*340\*60 mm

外箱规格: 360\*360\*220 mm

2KPCS/Reel    6KPCS/Inner Box    18KPCS/Outer Box

## Visual Inspection Standard of Product

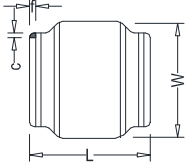
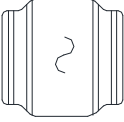
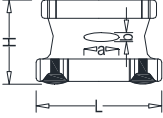
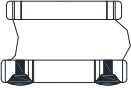
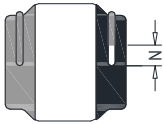
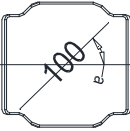
No.	Defect Item	Figure	Rejection Identification	Acceptance
1	Core Defect		The defect length(c or f)more than L/6 or W/6 , NG	AQL=0.65
2	Core Crack		Visual cracks , NG	AQL=0.65
3	Starvation		(1)Resin starved length a more than L/2, NG (2)When L>2mm,b>H/2, NG (3)When L≤2mm, b don't control	AQL=0.65
4	Excessive glue		The length, width or height of product beyond specified value, NG	AQL=0.65
5	Cold Solder		(1)For CR2520** Series , cold solder N>0.5mm,NG (2)For other series, cold solder N>1mm,NG	AQL=0.65
6	Marking Defect		The marking angle a>45° , NG	AQL=0.65

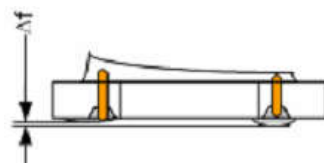

Δf: Clearance between terminal and the surface of plate must be 0.2mm max when coil is placed on a flat plate.



## X-ON Electronics

Largest Supplier of Electrical and Electronic Components

*Click to view similar products for [Fixed Inductors](#) category:*

*Click to view products by [Ceaiya](#) manufacturer:*

Other Similar products are found below :

[CR32NP-100KC](#) [CR54NP-470LC](#) [70F224AI](#) [MGDQ4-00004-P](#) [MHQ1005P10NJ](#) [MHQ1005P1N0S](#) [MHQ1005P2N4S](#) [MHQ1005P3N6S](#)  
[MHQ1005P5N1S](#) [MHQ1005P8N2J](#) [PE-53601NL](#) [PE-53602NL](#) [PG0936.113NLT](#) [9220-20](#) [9310-16](#) [PM06-2N7](#) [PM06-39NJ](#) [A01TK](#)  
[1206CS-471XJ](#) [HC2-R47-R](#) [HC8-1R2-R](#) [HCF1305-3R3-R](#) [1206CS-151XG](#) [RCH664NP-140L](#) [RCH664NP-4R7M](#) [RCP1317NP-391L](#)  
[RCR110DNP-331L](#) [DH2280-4R7M](#) [DS1608C-106](#) [B10TJ](#) [B82498B3101J000](#) [ELJ-RE27NJF2](#) [1812CS-153XJ](#) [1812CS-183XJ](#) [1812CS-](#)  
[223XJ](#) [1812LS-104XJ](#) [1812LS-105XJ](#) [1812LS-124XJ](#) [1812LS-154XJ](#) [1812LS-223XJ](#) [1812LS-224XJ](#) [1812LS-563XJ](#) [1812LS-683XJ](#)  
[1812LS-824XJ](#) [NIN-FB101JTR110F](#) [NIN-FB471JTR62F](#) [NIN-FC1R5JTR220F](#) [NIN-HCR15JTRF](#) [NIN-HCR33JTRF](#) [NIN-HDR22JTRF](#)