

Specification Sheet for Approved

Customer Name:	
Customer Part No.:	
Ceaiya Part No:	CR6045 Series
Spec No:	L050-2

【For Customer Approval Only】

If you Approval, Please Stamp

【RoHS Compliant Parts】

Approved By	Checked By	Prepared By
李庆辉	刘志坚	劳水花

Shenzhen Ceaiya Electronics Co., Ltd.

地址 1: 深圳市龙华区观湖街道鹭湖社区观盛二路 5 号捷顺科技中心 B706

地址 2: 东莞清溪镇青滨东路 105 号力合紫荆智能制造中心 10 栋

Http: //www.szceaiya.com

Tel: 0769-89135516

Fax: 0769-89135519

【Version of Changed Record】

Rev.	Effective Date	Changed Contents	Change Reasons	Approved By
A0	2023.05.25	New release	/	Li qing hui

1. Shape and Dimension (Unit:mm)

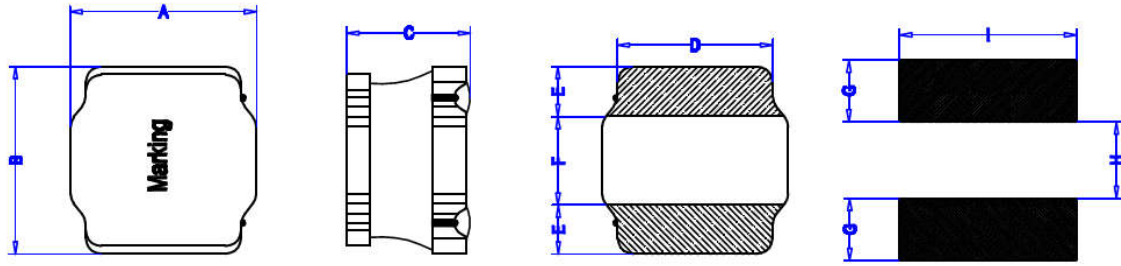

A	B	C	D	E	F	G	H	I
6.0 ± 0.3	6.0 ± 0.3	4.5 Max	4.9 ± 0.3	1.65 ± 0.3	2.7 ± 0.3	1.7 Ref	2.8 Ref	5.7 Ref

注：喷码尺寸长 3.6 ± 0.5mm, 宽 2.5 ± 0.5mm

2. Electronic Characteristics List

Part Number	Inductance (uH)	Tolerance (±%)	DCR(mΩ) ±30%	Isat (A)	Irise (A)	Test Condition	MARKING
CR6045-R56N	0.56	30	7.5	14.5	6.20	1MH /0.25V	R56
CR6045-1R0N/M	1.0	30,20	10	9.00	5.10	100KHz /0.25V	1R0
CR6045-1R2N	1.2	30	12	8.10	4.75	100KHz /0.25V	1R2
CR6045-1R5N/M	1.5	30,20	12	7.50	4.75	100KHz /0.25V	1R5
CR6045-1R8N	1.8	30	13	7.50	4.60	100KHz /0.25V	1R8
CR6045-2R2N/M	2.2	30,20	14	6.50	4.60	100KHz /0.25V	2R2
CR6045-3R3N/M	3.3	30,20	20	5.30	3.20	100KHz /0.25V	3R3
CR6045-3R9N	3.9	30	20	4.90	3.20	100KHz /0.25V	3R9
CR6045-4R7N/M	4.7	30,20	24	4.50	3.00	100KHz /0.25V	4R7
CR6045-5R6N	5.6	30	31	3.70	2.80	100KHz /0.25V	5R6
CR6045-6R8M	6.8	20	33	3.30	2.70	100KHz /0.25V	6R8
CR6045-8R2M	8.2	20	45	3.20	2.60	100KHz /0.25V	8R2
CR6045-100M	10	20	52	3.00	2.50	100KHz /0.25V	100
CR6045-120M	12	20	58	2.80	2.20	100KHz /0.25V	120
CR6045-150M	15	20	77	2.50	1.90	100KHz /0.25V	150
CR6045-180M	18	20	95	2.20	1.75	100KHz /0.25V	180
CR6045-220M	22	20	115	2.00	1.50	100KHz /0.25V	220
CR6045-270M	27	20	120	1.90	1.48	100KHz /0.25V	270
CR6045-330M	33	20	150	1.60	1.45	100KHz /0.25V	330
CR6045-390M	39	20	180	1.50	1.25	100KHz /0.25V	390
CR6045-470M	47	20	220	1.40	1.20	100KHz /0.25V	470
CR6045-560M	56	20	260	1.30	1.10	100KHz /0.25V	560
CR6045-680M	68	20	290	1.20	0.90	100KHz /0.25V	680
CR6045-820M	82	20	355	1.10	0.85	100KHz /0.25V	820
CR6045-101M	100	20	430	1.00	0.80	100KHz /0.25V	101
CR6045-121M	120	20	530	0.85	0.75	100KHz /0.25V	121
CR6045-151M	150	20	760	0.80	0.70	100KHz /0.25V	151
CR6045-181M	180	20	845	0.75	0.65	100KHz /0.25V	181
CR6045-221M	220	20	890	0.63	0.55	100KHz /0.25V	221

※ All test data is referenced to 25°C ambient;

Isat : DC Saturation Current that will cause initial inductance to drop approximately 30% max.

Irise : DC Current that will cause an approximate ΔT of 40 °C

Measuring Instrument :

L:HIOKI3532-50

DCR:HIOKI 3540

Isat / Irise: 6377&6220Microtest

3. General Characteristics

3-1. Storage Temperature range : $-40^{\circ}\text{C} \sim +105^{\circ}\text{C}$

3-2. Operating temperature range: $-40^{\circ}\text{C} \sim +125^{\circ}\text{C}$ (Including coil's self temperature rise)

3-3. External appearance : No external defects can be found in the visual inspection.

3-4. Electrode strength : No electrode detachment should be found when the device is pushed in two directions of X and Y with the force of 10.0N for 10 ± 2 seconds after soldering between copper plate and the electrodes.
(Refer to figure at right)

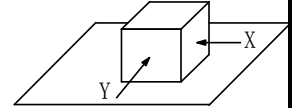

3-5. Vibration test : Inductance deviation is within $\pm 10.0\%$ after 1 hour sweeping vibration in each three directions, namely, forward and backward, up and down, right and left. The frequency is $10 \sim 55 \sim 10\text{Hz}$ and the amplitude of 1 minute cycle is 1.5mm PP.

3-6. Recommended reflow condition:

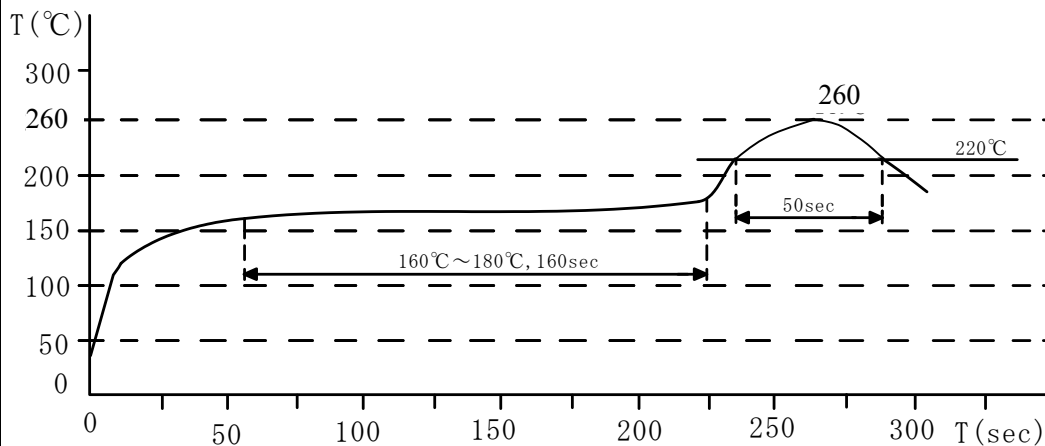

3-7. Humidity test : Inductance deviation is within $\pm 5.0\%$ after 96 ± 4 hours test under the condition of relative humidity of $90 \sim 95\%$ and temperature of $60 \pm 2^{\circ}\text{C}$, and 1 hour storage under room ambient conditions after the device is wiped with dry cloth.

LEAD-FREE



4. Construction and materials

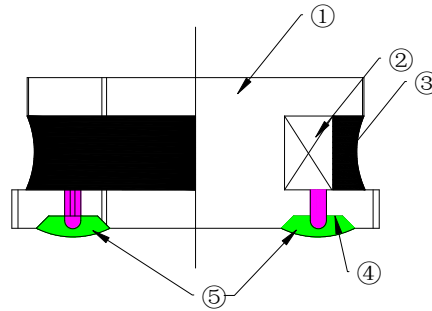

No.	Part name	Material	Ceaiya P/N
①	Drum Core	Ni-Zn Ferrite Core	CY/TW
②	Wire	Polyurethane enameled copper wire	YLSL
③	Adhesive	Epoxy Resin Magnetic Powder	CH
④	Plating Electrodes	Plating: Ag 3-7 μ m Ni 1-3 μ m Sn 3-7 μ m	
⑤	Outer Electrodes	Top surface solder coating Sn99%、 Ag0.3%、Cu0.7%	YX

5. Package Specification

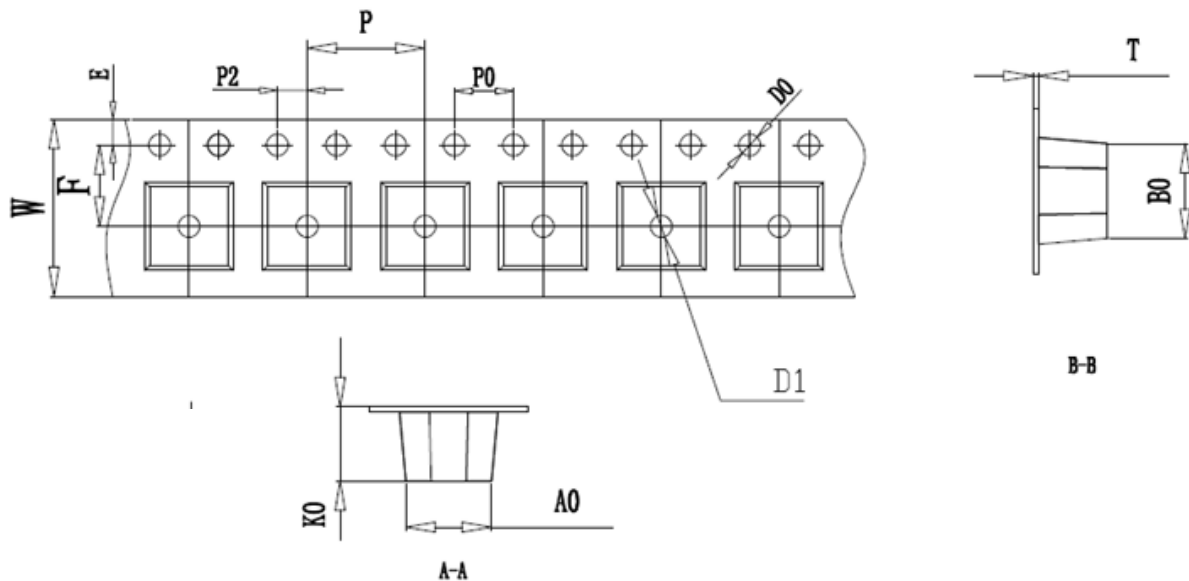

ITEM	W	A0	B0	K	P1	F	E	D0/D1	P0	P2	T
DIM	12.00	6.3	6.3	4.7	8.00	5.50	1.75	1.50	4.00	2.00	0.40
TOLE	± 0.3	± 0.1	± 0.1	± 0.1	± 0.1	± 0.1	± 0.1	+0.1	± 0.1	± 0.1	± 0.05

6. CARRIER REEL DIMENSIONS:

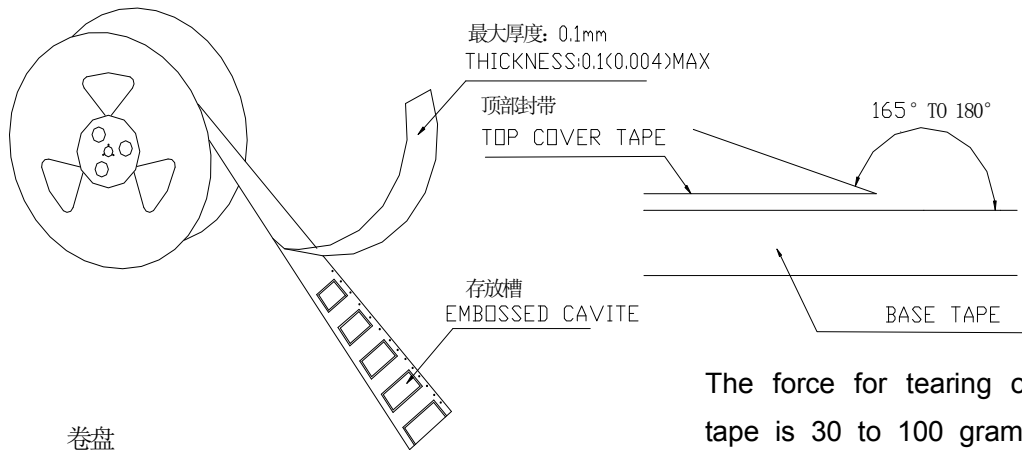

卷盘
Carrier Tape Reel

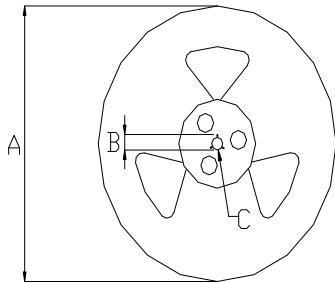

The force for tearing off cover tape is 30 to 100 grams in the arrow direction/按箭头的方向施加 30 克至 100 克力撕开

材质: 纸/塑胶

MATERIAL: PAPER/PLASTIC

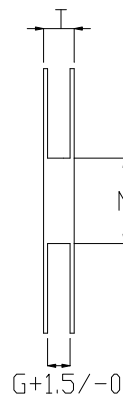

Unit: mm

Type	A	B	C	G	N	T
12mm	330	21±0.8	13±0.4	12.4	100	16.4

7. PACKAGE SPECIFICATION :

1.5KPCS/Reel 4.5KPCS/Inner Box 13.5KPCS/Outer Box

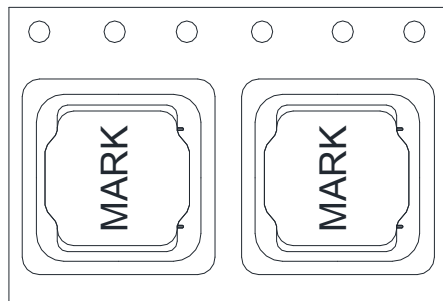

8. PACK :

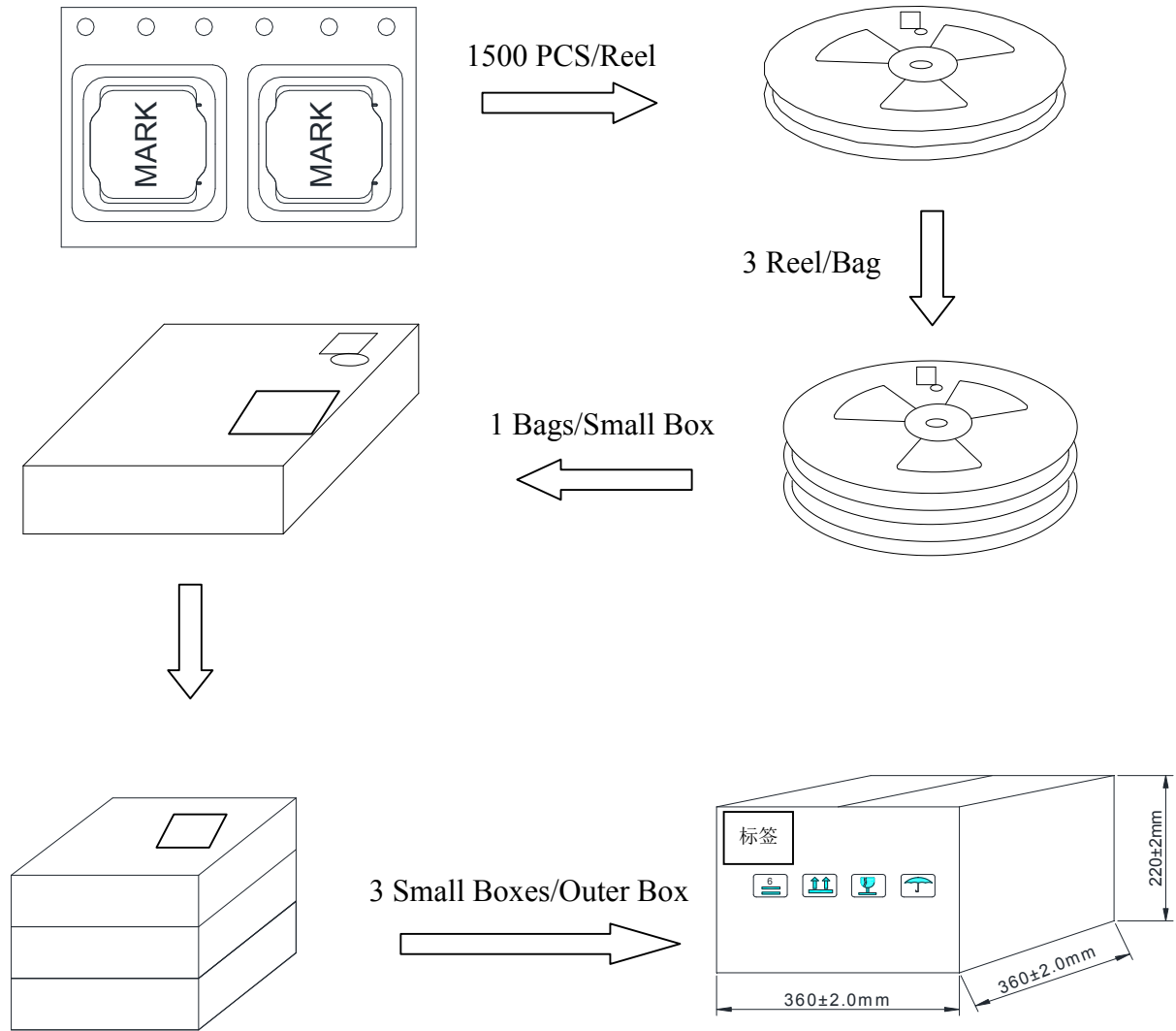

内箱规格: $350 \times 340 \times 60 \text{ mm}$

外箱规格: $360 \times 360 \times 220 \text{ mm}$

1.5KPCS/Reel 4.5KPCS/Inner Box 13.5KPCS/Outer Box

Visual Inspection Standard of Product

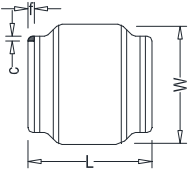
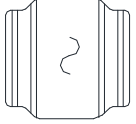
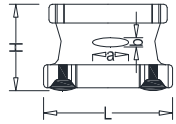
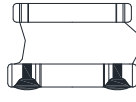
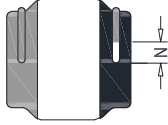
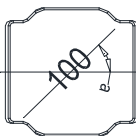
No.	Defect Item	Figure	Rejection Identification	Acceptance
1	Core Defect		The defect length(c or f) more than L/6 or W/6 , NG	AQL=0.65
2	Core Crack		Visual cracks , NG	AQL=0.65
3	Starvation		(1)Resin starved length a more than L/2, NG (2)When $L > 2\text{mm}$, $b > H/2$, NG (3)When $L \leq 2\text{mm}$, b don't control	AQL=0.65
4	Excessive glue		The length, width or height of product beyond specified value, NG	AQL=0.65
5	Cold Solder		(1)For CR2520** Series , cold solder $N > 0.5\text{mm}$, NG (2)For other series, cold solder $N > 1\text{mm}$, NG	AQL=0.65
6	Marking Defect		The marking angle $a > 45^\circ$, NG	AQL=0.65

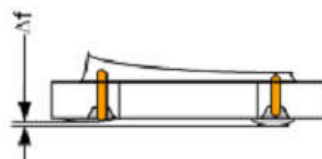

Δf : Clearance between terminal and the surface of plate must be 0.2mm max when coil is placed on a flat plate.

X-ON Electronics

Largest Supplier of Electrical and Electronic Components

Click to view similar products for [Fixed Inductors](#) category:

Click to view products by [Ceaiya](#) manufacturer:

Other Similar products are found below :

[CR32NP-100KC](#) [CR54NP-470LC](#) [70F224AI](#) [MGDQ4-00004-P](#) [MHQ1005P10NJ](#) [MHQ1005P1N0S](#) [MHQ1005P2N4S](#) [MHQ1005P3N6S](#)
[MHQ1005P5N1S](#) [MHQ1005P8N2J](#) [PE-53601NL](#) [PE-53602NL](#) [PG0936.113NLT](#) [9220-20](#) [9310-16](#) [PM06-2N7](#) [PM06-39NJ](#) [A01TK](#)
[1206CS-471XJ](#) [HC2-R47-R](#) [HC8-1R2-R](#) [HCF1305-3R3-R](#) [1206CS-151XG](#) [RCH664NP-140L](#) [RCH664NP-4R7M](#) [RCP1317NP-391L](#)
[RCR110DNP-331L](#) [DH2280-4R7M](#) [DS1608C-106](#) [B10TJ](#) [B82498B3101J000](#) [ELJ-RE27NJF2](#) [1812CS-153XJ](#) [1812CS-183XJ](#) [1812CS-](#)
[223XJ](#) [1812LS-104XJ](#) [1812LS-105XJ](#) [1812LS-124XJ](#) [1812LS-154XJ](#) [1812LS-223XJ](#) [1812LS-224XJ](#) [1812LS-563XJ](#) [1812LS-683XJ](#)
[1812LS-824XJ](#) [NIN-FB101JTR110F](#) [NIN-FB471JTR62F](#) [NIN-FC1R5JTR220F](#) [NIN-HCR15JTRF](#) [NIN-HCR33JTRF](#) [NIN-HDR22JTRF](#)