

## Specification Sheet for Approved

Customer Name:	
Customer Part No.:	
Ceaiya Part No:	CR6045K Series
Spec No:	L0645K

### 【For Customer Approval Only】

If you Approval, Please Stamp

### 【RoHS Compliant Parts】

Approved By	Checked By	Prepared By
李庆辉	刘志坚	劳水花

## Shenzhen Ceaiya Electronics Co., Ltd.

地址 1: 深圳市龙华区观湖街道鹭湖社区观盛二路 5 号捷顺科技中心 B706

地址 2: 广东省东莞清溪镇青滨东路 105 号力合紫荆智能制造中心 10 栋

Http://www.szceaiya.com

Tel: 0769-89135516

Fax: 0769-89135519

**【Version of Changed Record】**

Rev.	Effective Date	Changed Contents	Change Reasons	Approved By
A0	2023.05.25	New release	/	Li qing hui

## 1. Shape and Dimension ( Unit:mm )

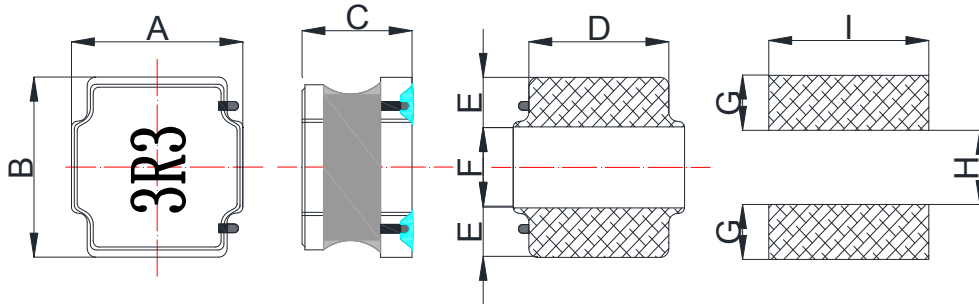

A	B	C	D	E	F	G	H	I
6.0 ± 0.3	6.0 ± 0.3	4.5 Max	4.9 ± 0.3	1.65 ± 0.3	2.7 ± 0.3	1.7 Ref	2.8 Ref	5.7 Ref

注：喷码尺寸长 3.6 ± 0.5mm, 宽 2.5 ± 0.5mm

## 2. Electronic Characteristics List

Part Number	Inductance	DC Resistance		Saturation Current		Heat Rating Current		Marking
	100KHz/1V	Max.	Typ.	Max.	Typ.	Max.	Typ.	
Units	uH	Ω	Ω	A	A	A	A	
Symbol	L	DCR		Isat		Irms		
CR6045K-1R0N	1.0 ± 30%	0.014	0.011	9.85	10.0	5.14	5.60	1R0
CR6045K-1R8N	1.8 ± 30%	0.016	0.012	7.60	8.40	4.95	5.40	1R8
CR6045K-2R2N	2.2 ± 30%	0.018	0.014	6.75	7.40	4.60	5.00	2R2
CR6045K-2R7N	2.7 ± 30%	0.020	0.015	5.75	6.30	4.30	4.70	2R7
CR6045K-3R3N	3.3 ± 30%	0.027	0.021	5.90	6.20	3.70	4.00	3R3
CR6045K-3R6N	3.6 ± 30%	0.027	0.021	5.25	5.70	3.70	4.00	3R6
CR6045K-4R7M	4.7 ± 20%	0.034	0.026	4.97	5.50	3.30	3.60	4R7
CR6045K-5R1M	5.1 ± 20%	0.034	0.026	4.40	4.80	3.30	3.60	5R1
CR6045K-5R6M	5.6 ± 20%	0.038	0.029	4.15	4.60	3.15	3.40	5R6
CR6045K-6R8M	6.8 ± 20%	0.040	0.031	3.90	4.30	3.00	3.30	6R8
CR6045K-100M	10 ± 20%	0.062	0.048	3.20	3.50	2.45	2.70	100
CR6045K-120M	12 ± 20%	0.075	0.058	2.80	3.00	2.20	2.40	120
CR6045K-150M	15 ± 20%	0.088	0.068	2.50	2.70	2.05	2.20	150
CR6045K-180M	18 ± 20%	0.105	0.081	2.20	2.40	1.85	2.00	180
CR6045K-220M	22 ± 20%	0.116	0.089	2.05	2.20	1.80	2.00	220
CR6045K-270M	27 ± 20%	0.133	0.102	1.90	2.10	1.65	1.80	270
CR6045K-300M	30 ± 20%	0.172	0.132	1.70	1.80	1.50	1.60	300
CR6045K-330M	33 ± 20%	0.178	0.137	1.65	1.80	1.45	1.60	330
CR6045K-360M	36 ± 20%	0.225	0.173	1.62	1.80	1.40	1.50	360
CR6045K-390M	39 ± 20%	0.234	0.180	1.50	1.60	1.25	1.40	390
CR6045K-470M	47 ± 20%	0.260	0.200	1.40	1.50	1.20	1.30	470
CR6045K-560M	56 ± 20%	0.287	0.221	1.30	1.40	1.10	1.20	560
CR6045K-680M	68 ± 20%	0.376	0.289	1.20	1.30	1.00	1.10	680
CR6045K-820M	82 ± 20%	0.443	0.341	1.05	1.10	0.90	0.99	820
CR6045K-101M	100 ± 20%	0.563	0.433	0.95	1.00	0.80	0.88	101
CR6045K-121M	120 ± 20%	0.629	0.484	0.85	0.94	0.77	0.85	121
CR6045K-151M	150 ± 20%	0.754	0.580	0.80	0.88	0.70	0.77	151
CR6045K-221M	220 ± 20%	1.084	0.834	0.70	0.77	0.59	0.65	221
CR6045K-331M	330 ± 20%	1.651	1.270	0.57	0.63	0.57	0.63	331
CR6045K-681M	680 ± 20%	3.250	2.500	0.42	0.46	0.33	0.38	681
CR6045K-102M	1000 ± 20%	5.850	4.500	0.30	0.35	0.30	0.35	102
CR6045K-152M	1500 ± 20%	8.450	6.500	0.24	0.27	0.21	0.24	152
CR6045K-222M	2200 ± 20%	12.48	10.40	0.20	0.23	0.17	0.20	222

※ All test data is referenced to 25°C ambient;

**Isat** : DC Saturation Current that will cause initial inductance to drop approximately 30% max.

**Irise** : DC Current that will cause an approximate ΔT of 40 °C

**Measuring Instrument :**

L:HIOKI3532-50

DCR:HIOKI 3540

Isat / Irise: HP4284A+42841

### 3. General Characteristics

3-1. Storage Temperature range :  $-40^{\circ}\text{C} \sim +105^{\circ}\text{C}$

3-2. Operating temperature range:  $-40^{\circ}\text{C} \sim +125^{\circ}\text{C}$  (Including coil's self temperature rise)

3-3. External appearance : No external defects can be found in the visual inspection.

3-4. Electrode strength : No electrode detachment should be found when the device is pushed in two directions of X and Y with the force of 10.0N for  $10 \pm 2$  seconds after soldering between copper plate and the electrodes.  
(Refer to figure at right)

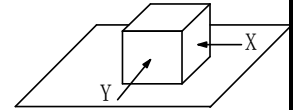

3-5. Vibration test : Inductance deviation is within  $\pm 10.0\%$  after 1 hour sweeping vibration in each three directions, namely, forward and backward, up and down, right and left. The frequency is  $10 \sim 55 \sim 10\text{Hz}$  and the amplitude of 1 minute cycle is 1.5mm PP.

3-6. Recommended reflow condition:

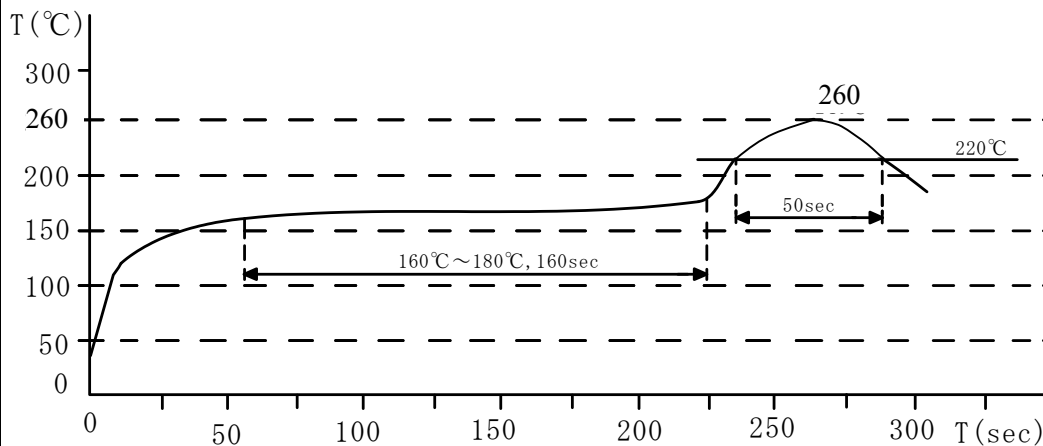

3-7. Humidity test : Inductance deviation is within  $\pm 5.0\%$  after  $96 \pm 4$  hours test under the condition of relative humidity of  $90 \sim 95\%$  and temperature of  $60 \pm 2^{\circ}\text{C}$ , and 1 hour storage under room ambient conditions after the device is wiped with dry cloth.

**LEAD-FREE**



#### 4. Construction and materials

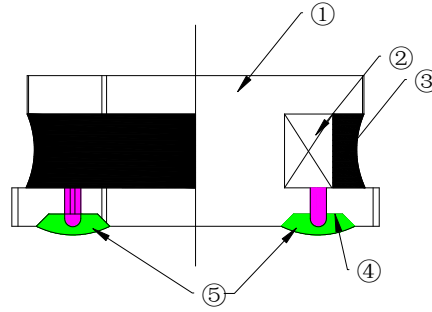

No.	Part name	Material	Ceaiya P/N
①	Drum Core	Ni-Zn Ferrite Core	CY/TW
②	Wire	Polyurethane enameled copper wire	YLSL
③	Adhesive	Epoxy Resin Magnetic Powder	CH/DZ
④	Plating Electrodes	Plating: Ag 3-7 $\mu$ m Ni 1-3 $\mu$ m Sn 3-7 $\mu$ m	
⑤	Outer Electrodes	Top surface solder coating Sn99%、 Ag0.3%、Cu0.7%	YX

#### 5. Package Specification

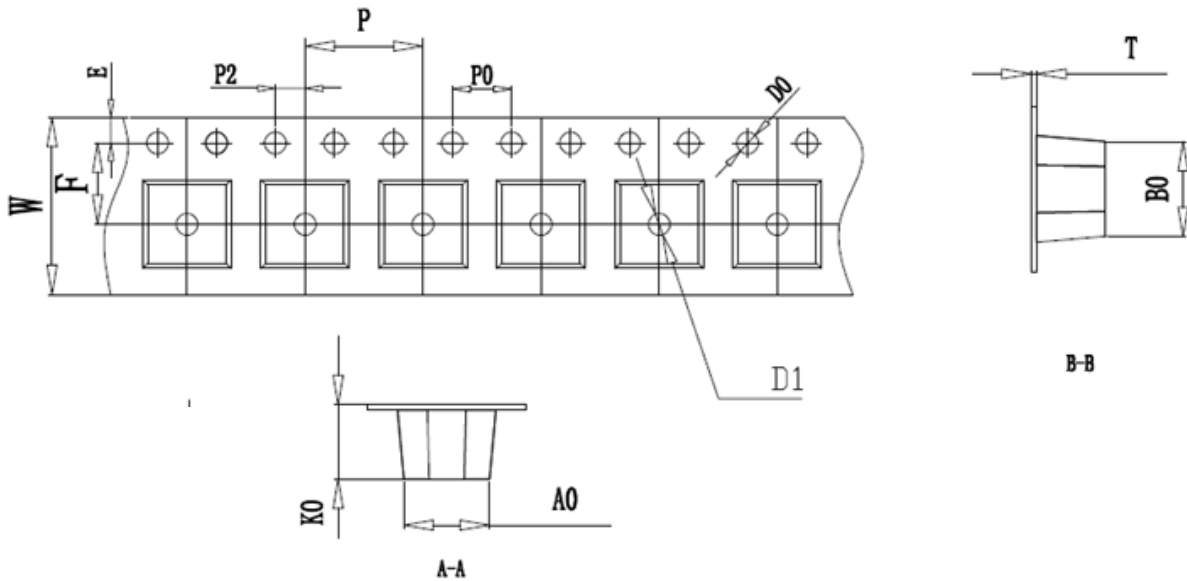

ITEM	W	A0	B0	K	P1	F	E	D0	P0	P2	T
DIM	12.00	6.3	6.3	4.7	8.00	5.50	1.75	1.50	4.00	2.00	0.40
TOLE	$\pm 0.3$	$\pm 0.1$	$\pm 0.1$	$\pm 0.1$	$\pm 0.1$	$\pm 0.1$	$\pm 0.1$	+0.1	$\pm 0.1$	$\pm 0.1$	$\pm 0.05$

## 6. CARRIER REEL DIMENSIONS:

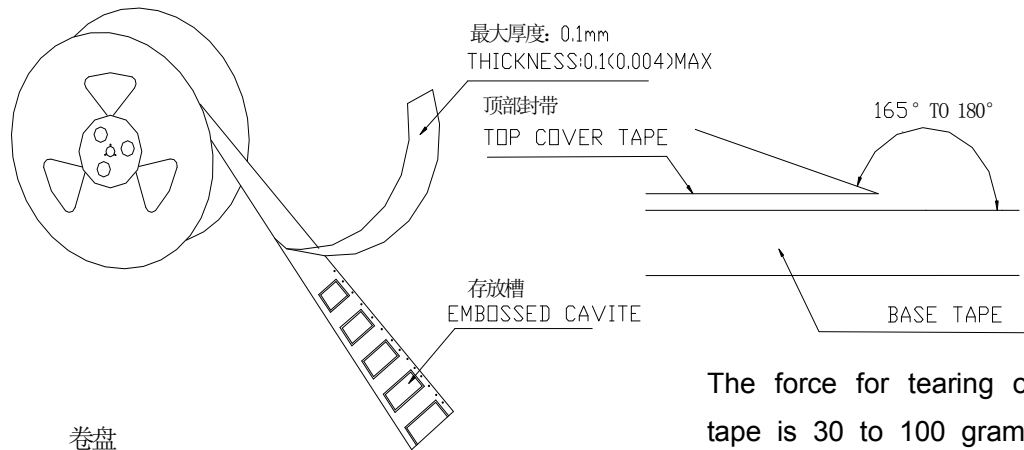

卷盘  
Carrier Tape Reel

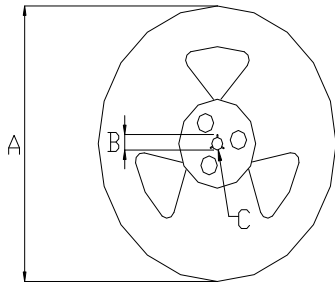

The force for tearing off cover tape is 30 to 100 grams in the arrow direction/按箭头的方向施加 30 克至 100 克力撕开

材质: 纸/塑胶

MATERIAL: PAPER/PLASTIC

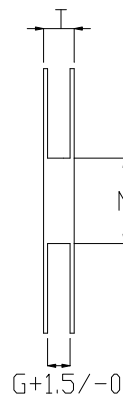

Unit: mm

Type	A	B	C	G	N	T
12mm	330	21±0.8	13±0.4	12.4	100	16.4

## 7. PACKAGE SPECIFICATION :

1.5KPCS/Reel    4.5KPCS/Inner Box    13.5KPCS/Outer Box

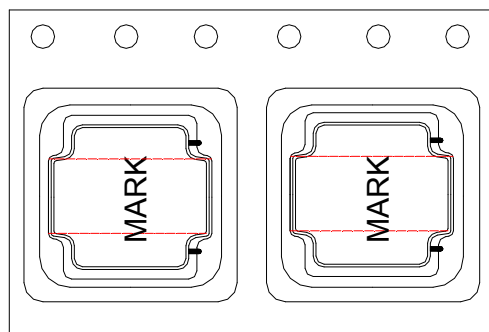

## Visual Inspection Standard of Product

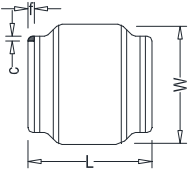
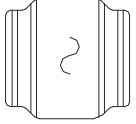
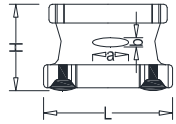
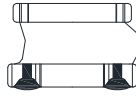
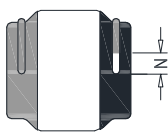
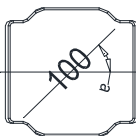
No.	Defect Item	Figure	Rejection Identification	Acceptance
1	Core Defect		The defect length(c or f)more than L/6 or W/6 , NG	AQL=0.65
2	Core Crack		Visual cracks , NG	AQL=0.65
3	Starvation		(1)Resin starved length a more than L/2, NG (2)When L>2mm,b>H/2, NG (3)When L≤2mm, b don't control	AQL=0.65
4	Excessive glue		The length, width or height of product beyond specified value, NG	AQL=0.65
5	Cold Solder		(1)For CR2520** Series , cold solder N>0.5mm,NG (2)For other series, cold solder N>1mm,NG	AQL=0.65
6	Marking Defect		The marking angle a>45° , NG	AQL=0.65

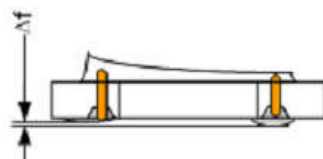

Δf: Clearance between terminal and the surface of plate must be 0.2mm max when coil is placed on a flat plate.

## X-ON Electronics

Largest Supplier of Electrical and Electronic Components

*Click to view similar products for [Fixed Inductors](#) category:*

*Click to view products by [Ceaiya](#) manufacturer:*

Other Similar products are found below :

[CR32NP-100KC](#) [CR54NP-470LC](#) [70F224AI](#) [MGDQ4-00004-P](#) [MHQ1005P10NJ](#) [MHQ1005P1N0S](#) [MHQ1005P2N4S](#) [MHQ1005P3N6S](#)  
[MHQ1005P5N1S](#) [MHQ1005P8N2J](#) [PE-53601NL](#) [PE-53602NL](#) [PG0936.113NLT](#) [9220-20](#) [9310-16](#) [PM06-2N7](#) [PM06-39NJ](#) [A01TK](#)  
[1206CS-471XJ](#) [HC2-R47-R](#) [HC8-1R2-R](#) [HCF1305-3R3-R](#) [1206CS-151XG](#) [RCH664NP-140L](#) [RCH664NP-4R7M](#) [RCP1317NP-391L](#)  
[RCR110DNP-331L](#) [DH2280-4R7M](#) [DS1608C-106](#) [B10TJ](#) [B82498B3101J000](#) [ELJ-RE27NJF2](#) [1812CS-153XJ](#) [1812CS-183XJ](#) [1812CS-](#)  
[223XJ](#) [1812LS-104XJ](#) [1812LS-105XJ](#) [1812LS-124XJ](#) [1812LS-154XJ](#) [1812LS-223XJ](#) [1812LS-224XJ](#) [1812LS-563XJ](#) [1812LS-683XJ](#)  
[1812LS-824XJ](#) [NIN-FB101JTR110F](#) [NIN-FB471JTR62F](#) [NIN-FC1R5JTR220F](#) [NIN-HCR15JTRF](#) [NIN-HCR33JTRF](#) [NIN-HDR22JTRF](#)