

## Specification Sheet for Approved

Customer Name:	
Customer Part No.:	
Ceaiya Part No:	CRH252012S 系列
Spec No:	L2512

**【For Customer Approval Only】**

If you Approval, Please Stamp

**【RoHS Compliant Parts】**

Approved By	Checked By	Prepared By
李庆辉	查凯	水花

### Shenzhen Ceaiya Electronics Co., Ltd.

地址 1: 深圳市龙华区观澜街道银星智界一期综合楼 716 号

地址 2: 广东省东莞清溪镇青滨东路 105 号力合紫荆智能制造中心 10 栋

Http://www.ceaiya.com

Tel: 0769-89135516

Fax: 0769-89135519



# Specification Sheet for SMD Power Inductor

## 1. Scope

This specification applies to the CRH252012S Series of wire wound SMD power inductor.

## 2. Product Description and Identification (Part Number)

1) Description:

CRH252012S series of Wire wound SMD power inductor.

2) Product Identification (Part Number)

CRH   252012   S   -   2R2   M   T  
 ①            ②            ③            ④            ⑤            ⑥

① Type	
CRH	Ferrite Inductor

② External Dimensions(L×W×H) 【mm】	
252012	2.5×2.0×1.2

③ Feature type	
S	Standard Product

④ Nominal Inductance	
Example	Example
1R0	1.0uH
100	10uH
101	100uH

⑤ Inductance Tolerance	
N	±30%
M	±20%

⑥ Packing	
T	Tape Carrier Package

## 3. Electrical Characteristics

Please refer to Item 5.

- 1) Operating temperature range (individual chip without packing): -40℃ ~ +125℃ (Including Self-heating)
- 2) Storage temperature range (packaging conditions): -10℃ ~ +40℃ and RH 70% (Max.).

## 4. Shape and Dimensions (Unit:mm)

Dimensions and recommended PCB pattern for reflow soldering, please see Fig4-1 and Table4-1

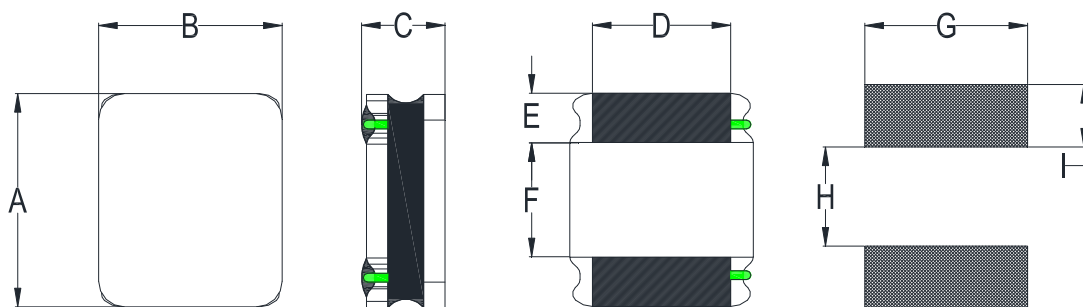

Fig4-1.

Table 4-1.

A	B	C	D	E	F	G	H	I
2.5±0.2	2.0±0.2	1.25Max	1.5±0.2	0.8±0.2	0.8±0.2	2.0Ref	0.8 Ref	0.85 Ref

# Specification Sheet for SMD Power Inductor

## 5. Electrical Characteristics

Part Number	Inductance	DC Resistance		Saturation Current		Heat Rating Current	
	1MHz/1V	Max.	Typ.	Max.	Typ.	Max.	Typ.
Units	uH	$\Omega$	$\Omega$	A	A	A	A
Symbol	L	DCR		Isat		Irms	
CRH252012S-R24MT	0.24±20%	0.023	0.019	4.10	4.80	4.10	4.50
CRH252012S-R33MT	0.33±20%	0.031	0.026	4.00	4.70	3.35	3.70
CRH252012S-R47MT	0.47±20%	0.036	0.031	3.80	4.50	3.00	3.30
CRH252012S-R68MT	0.68±20%	0.047	0.038	3.00	3.30	2.30	2.50
CRH252012S-1R0MT	1.0±20%	0.060	0.050	2.25	2.50	2.30	2.60
CRH252012S-1R2MT	1.2±20%	0.078	0.065	2.20	2.50	2.00	2.20
CRH252012S-1R5MT	1.5±20%	0.090	0.075	2.00	2.35	1.80	2.00
CRH252012S-1R8MT	1.8±20%	0.108	0.093	1.95	2.20	1.75	1.90
CRH252012S-2R2MT	2.2±20%	0.108	0.093	1.75	1.90	1.75	1.90
CRH252012S-2R7MT	2.7±20%	0.156	0.130	1.30	1.60	1.40	1.50
CRH252012S-3R3MT	3.3±20%	0.156	0.130	1.20	1.35	1.40	1.50
CRH252012S-4R7MT	4.7±20%	0.228	0.190	1.10	1.20	1.10	1.20
CRH252012S-5R6MT	5.6±20%	0.330	0.255	1.00	1.10	1.00	1.15
CRH252012S-6R8MT	6.8±20%	0.360	0.300	0.90	1.10	0.95	1.05
CRH252012S-100MT	10±20%	0.522	0.435	0.70	0.85	0.78	0.86
CRH252012S-150MT	15±20%	1.000	0.700	0.60	0.70	0.50	0.60
CRH252012S-220MT	22±20%	1.290	1.000	0.45	0.55	0.48	0.55

Note:※1: Rated current: Isat(max.)or Irms(max.),whichever is smaller;

※2: Saturation Current: Max. Value, DC current at which the inductance drops less than 30% from its value without current; Typ. Value, DC current at which the inductance drops 30% from its value without current;

※3: Irms: DC current that causes the temperature rise ( $\Delta T$ ) from 20°C ambient.

For Max. Value,  $\Delta T < 40^\circ\text{C}$ ; for Typ. Value,  $\Delta T$  is approximate 40°C.

The part temperature (ambient + temp. rise) should not exceed 125°C under worst case operating conditions. Circuit design, component placement, PCB trace size and thickness, airflow and other cooling provisions all affect the part temperature. Part temperature should be verified in the end application.

## 6. Structure

The structure of CRH252012S product.

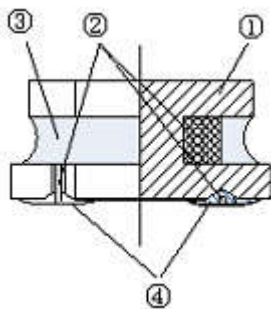

NO.	Components	Material
①	Core	Ni-Zn Ferrite
②	Wire	Polyurethane system enameled copper wire
③	Magnetic Glue	Epoxy resin and magnetic powder
④	Electrodes	AgNiSn or FeNiCu + Sn Alloy

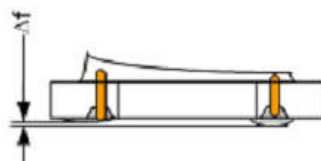

$\Delta f$ : Clearance between terminal and the surface of plate must be 0.1mm max when coil is placed on a flat plate.

# Specification Sheet for SMD Power Inductor

## 7. Reliability Test

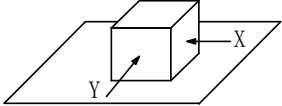
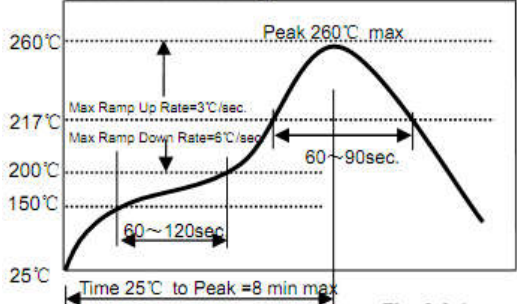
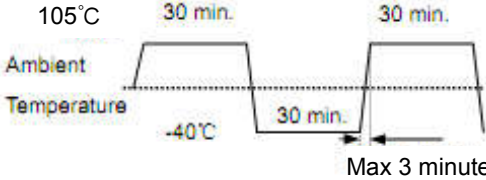
Items	Requirements	Test Methods and Remarks
7.1 Terminal Strength	No removal or split of the termination or other defects shall occur.   Fig.7.1-1	1) Solder the inductor to the testing jig (glass epoxy board shown in Fig.7.1-1) using eutectic solder. Then apply a force in the direction of the arrow. 2) 10N force. 3) Keep time: 5±2s
7.2 High Temperature	1. No visible mechanical damage. 2. Inductance change: Within ±10%	1) Storage Temperature :125+/-5°C 2) Duration : 96 ±4 Hours 3) Recovery : then measured at room ambient temperature after placing 24 hours.
7.3 Low Temperature	1. No visible mechanical damage 2. Inductance change: Within ±10%	1) Temperature and time: -40±5°C 2) Duration: 96±4 hours 3) TRecovery : then measured at room ambient temperature after placing 24 hours.
7.4 Vibration test	1. No visible mechanical damage. 2. Inductance change: Within ±10%	1) Frequency range:10HZ~55HZ~10HZ 2) Amplitude:1.5mm p-p 3) Direction:X,Y,Z 4) Time:1 minute/cycle,2hours per axis
7.5 High Temperature Storage Tested	1. No visible mechanical damage. 2. Inductance change: Within ±10%	1) Storage Temperature :60+/-2°C 2) Relative Humidity :90-95% RH 3) Duration : 96 ±4 Hours 4) Recovery : then measured at room ambient temperature after placing 24 hours.
7.6 Resistance to Soldering Heat	1. No visible mechanical damage. 2. Inductance change: Within ±10%   Fig.7.6-1	1) Re-flowing Profile: Please refer to Fig.7.6-1 2) Test board thickness: 1.0mm 3) Test board material: glass epoxy resin 4) The chip shall be stabilized at normal condition for 1~2 hours before measuring
7.7 Thermal Shock	1. No visible mechanical damage. 2. Inductance change: Within ±10%   Fig.7.7-1	1) Temperature and time: -40±3°C for 30±3 min→105°C for 30±3min, please refer to Fig.7.7-1. 2) Transforming interval: Max, 3 minute 3) Tested cycle: 100 cycles 4) The chip shall be stabilized at normal condition for 1~2 hours before measuring

# Specification Sheet for SMD Power Inductor

## 8. Packaging and Marking:

### 8-1. Carrier Tape Dimensions:

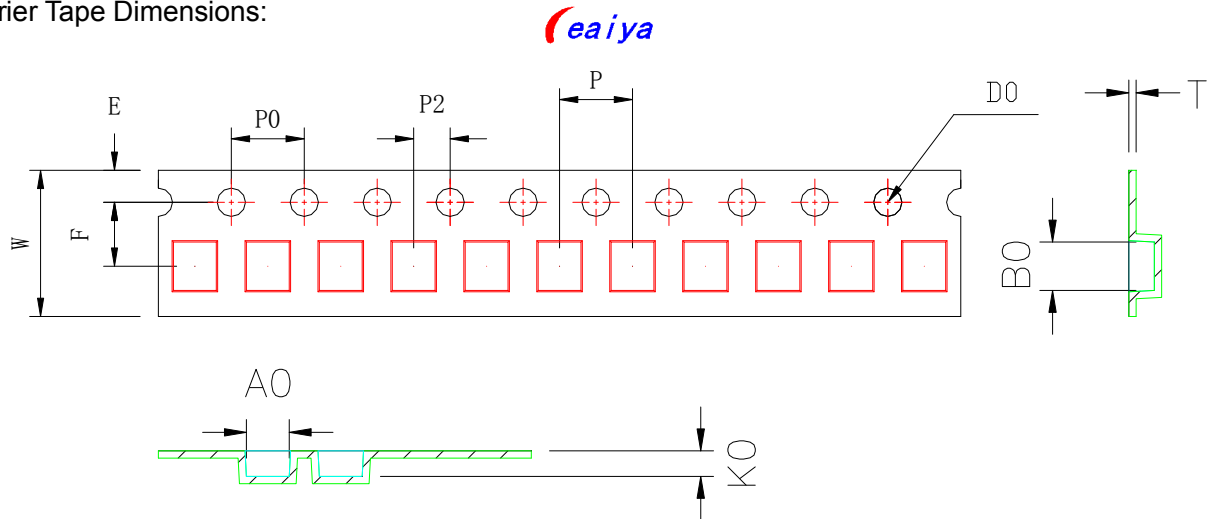

ITEM	W	A0	B0	K0	P	F	E	D0	P0	P2	T
DIM	8.00	2.35	2.65	1.4	4.00	3.5	1.75	1.50	4.00	2.00	0.25
TOLE	±0.3	±0.1	±0.1	±0.1	±0.1	±0.1	±0.1	+0.1	±0.1	±0.1	±0.05

### 8-2. Taping Dimensions:

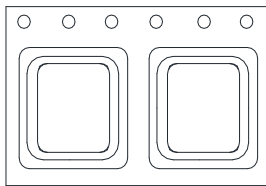

### 8-3. Reel Dimensions:

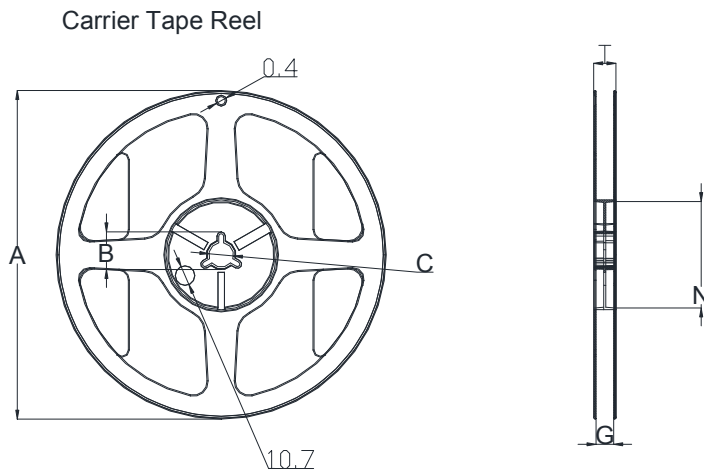

Type	A	B	C	G	N	T
8mm	178	20.7±0.8	13±0.4	9	60	10.8

### 8-4. Packaging Quantity:

2KPCS/ Reel    20KPCS/ Inner Box    80KPCS/ Outer Box

## 9. Visual Inspection Standard of Product

## Specification Sheet for SMD Power Inductor

### Visual Inspection Standard of Product

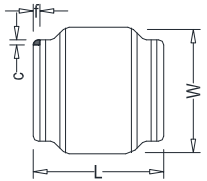
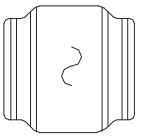
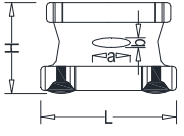
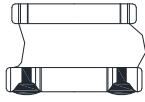
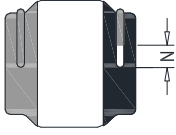
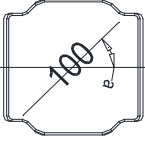
No.	Defect Item	Figure	Rejection Identification	Acceptance
1	Core Defect		The defect length(c or f) more than L/6 or W/6 , NG	AQL=0.65
2	Core Crack		Visual cracks , NG	AQL=0.65
3	Starvation		(1)Resin starved length a more than L/2, NG (2)When L>2mm,b>H/2, NG (3)When L≤2mm, b don't control	AQL=0.65
4	Excessive glue		The length, width or height of product beyond specified value, NG	AQL=0.65
5	Cold Solder		(1)For CR2520** Series , cold solder N>0.5mm,NG (2)For other series, cold solder N>1mm,NG	AQL=0.65
6	Marking Defect		The marking angle a>45° , NG	AQL=0.65

## X-ON Electronics

Largest Supplier of Electrical and Electronic Components

*Click to view similar products for [Fixed Inductors](#) category:*

*Click to view products by [Ceaiya](#) manufacturer:*

Other Similar products are found below :

[MLZ1608M6R8WTD25](#) [MLZ1608N6R8LT000](#) [MLZ1608N3R3LTD25](#) [MLZ1608N3R3LT000](#) [MLZ1608N150LT000](#)

[MLZ1608M150WTD25](#) [MLZ1608M3R3WTD25](#) [MLZ1608M3R3WT000](#) [MLZ1608M150WT000](#) [MLZ1608A1R5WT000](#)

[MLZ1608N1R5LT000](#) [B82432C1333K000](#) [PCMB053T-1R0MS](#) [PCMB053T-1R5MS](#) [PCMB104T-1R5MS](#) [CR32NP-100KC](#) [CR32NP-](#)

[151KC](#) [CR32NP-180KC](#) [CR32NP-181KC](#) [CR32NP-1R5MC](#) [CR32NP-390KC](#) [CR32NP-3R9MC](#) [CR32NP-680KC](#) [CR32NP-820KC](#)

[CR32NP-8R2MC](#) [CR43NP-390KC](#) [CR43NP-560KC](#) [CR43NP-680KC](#) [CR54NP-181KC](#) [CR54NP-470LC](#) [CR54NP-820KC](#) [CR54NP-8R5MC](#)

[MGDQ4-00004-P](#) [MGDU1-00016-P](#) [MHL1ECTTP18NJ](#) [MHL1JCTTD12NJ](#) [PE-51506NL](#) [PE-53601NL](#) [PE-53630NL](#) [PE-53824SNLT](#) [PE-](#)

[62892NL](#) [PE-92100NL](#) [PG0434.801NLT](#) [PG0936.113NLT](#) [PM06-2N7](#) [PM06-39NJ](#) [HC2LP-R47-R](#) [HC2-R47-R](#) [HC3-2R2-R](#) [HC8-1R2-R](#)