

Specification Sheet for Approved

| | |
|--------------------|-----------------|
| Customer Name: | |
| Customer Part No.: | |
| Ceaiya Part No: | MAI4020S Series |
| Spec No: | L4020 |

【For Customer Approval Only】

If you Approval, Please Stamp

【RoHS Compliant Parts】

| Approved By | Checked By | Prepared By |
|-------------|------------|-------------|
| 李庆辉 | 刘志坚 | 劳水花 |

Shenzhen Ceaiya Electronics Co., Ltd.

深圳地址 1: 深圳市龙华区观湖街道鹭湖社区观盛二路 5 号捷顺科技中心 B706

东莞地址 2: 广东省东莞清溪镇青滨东路 105 号力合紫荆智能制造中心 10 栋

Http://www.szceaiya.com

Tel: 0769-89135516

Fax: 0769-89135519

Specification Sheet for SMD Power Inductor

1. Scope

This specification applies to the MAI4020S Series of wire wound SMD power inductor.

2. Product Description and Identification (Part Number)

1) Description:

MAI4020S series of Wire wound SMD power inductor.

2) Product Identification (Part Number)

MAI 4020 S - 2R2 M T
 ① ② ③ ④ ⑤ ⑥

| | |
|--------|----------------------|
| ① Type | |
| MAI | Metal Alloy Inductor |

| | |
|-----------------------------------|-------------|
| ② External Dimensions(L×W×H) 【mm】 | |
| 4020 | 4.0×4.0×2.0 |

| | |
|----------------|--------------------|
| ③ Feature type | |
| S | High Type Material |

| | |
|----------------------|---------|
| ④ Nominal Inductance | |
| Example | Example |
| 1R0 | 1.0uH |
| 100 | 10uH |
| 101 | 100uH |

| | |
|------------------------|------|
| ⑤ Inductance Tolerance | |
| N | ±30% |
| M | ±20% |

| | |
|-----------|----------------------|
| ⑥ Packing | |
| T | Tape Carrier Package |

3. Electrical Characteristics

Please refer to Item 12.

- 1) Operating temperature range (individual chip without packing): -40°C ~ +125°C (Including Self-heating) .
- 2) Storage temperature range (packaging conditions): -10°C ~ +40°C and RH 70% (Max.).

4. Shape and Dimensions (Unit:mm)

Dimensions and recommended PCB pattern for reflow soldering, please see

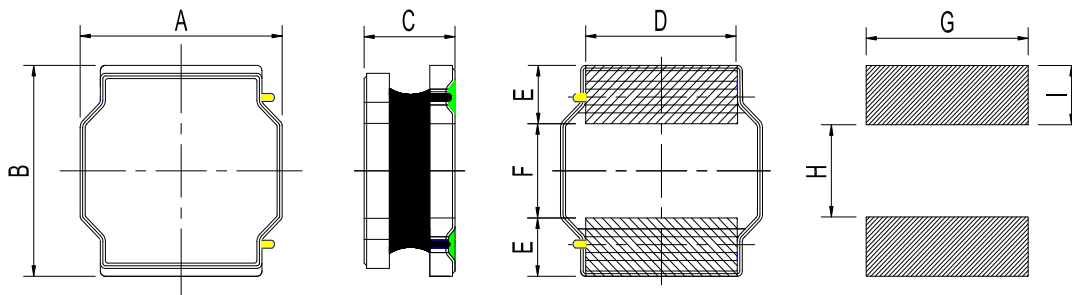

| A | B | C | D | E | F | G | H | I |
|-----------|-----------|--------|---------|----------|---------|-----|-----|-----|
| 4.0 ± 0.2 | 4.0 ± 0.2 | 2.0Max | 3.3±0.3 | 1.05±0.3 | 1.9±0.3 | 3.7 | 1.9 | 1.1 |

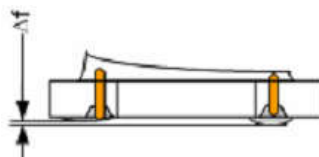

Δf: Clearance between terminal and the surface of plate must be 0.15mm max when coil is placed on a flat plate.

Specification Sheet for SMD Power Inductor

5. Electrical Characteristics

| Part Number | Inductance | DC Resistance | | Saturation Current | | Heat Rating Current | |
|----------------|------------|---------------|----------|--------------------|------|---------------------|------|
| | 1MHz/1V | Max. | Typ. | Max. | Typ. | Max. | Typ. |
| Units | uH | Ω | Ω | A | A | A | A |
| Symbol | L | DCR | | Isat | | Irms | |
| MAI4020S-R24MT | 0.24±20% | 0.017 | 0.013 | 14.0 | 17.0 | 6.00 | 7.00 |
| MAI4020S-R33MT | 0.33±20% | 0.020 | 0.015 | 13.0 | 16.0 | 5.90 | 6.80 |
| MAI4020S-R47MT | 0.47±20% | 0.022 | 0.016 | 11.0 | 12.0 | 5.90 | 6.80 |
| MAI4020S-R68MT | 0.68±20% | 0.0245 | 0.0192 | 9.00 | 11.5 | 5.80 | 6.70 |
| MAI4020S-1R0MT | 1.0±20% | 0.028 | 0.023 | 8.70 | 11.0 | 5.80 | 6.70 |
| MAI4020S-1R5MT | 1.5±20% | 0.038 | 0.032 | 7.70 | 9.60 | 5.20 | 6.00 |
| MAI4020S-1R8MT | 1.8±20% | 0.056 | 0.046 | 6.30 | 7.80 | 4.00 | 4.80 |
| MAI4020S-2R2MT | 2.2±20% | 0.056 | 0.046 | 6.00 | 7.50 | 4.00 | 4.80 |
| MAI4020S-3R3MT | 3.3±20% | 0.088 | 0.073 | 4.70 | 5.90 | 3.40 | 4.00 |
| MAI4020S-3R9MT | 3.9±20% | 0.100 | 0.078 | 4.10 | 5.00 | 3.00 | 3.50 |
| MAI4020S-4R7MT | 4.7±20% | 0.115 | 0.095 | 4.00 | 4.90 | 2.85 | 3.30 |
| MAI4020S-6R8MT | 6.8±20% | 0.160 | 0.130 | 3.00 | 4.20 | 2.40 | 2.80 |
| MAI4020S-8R2MT | 8.2±20% | 0.220 | 0.175 | 2.90 | 3.80 | 2.10 | 2.40 |
| MAI4020S-100MT | 10±20% | 0.220 | 0.190 | 2.80 | 3.50 | 2.00 | 2.35 |
| MAI4020S-120MT | 12±20% | 0.286 | 0.220 | 2.30 | 3.20 | 1.50 | 1.90 |
| MAI4020S-150MT | 15±20% | 0.400 | 0.305 | 2.10 | 2.80 | 1.00 | 1.20 |
| MAI4020S-220MT | 22±20% | 0.545 | 0.415 | 1.30 | 1.50 | 0.95 | 1.10 |
| MAI4020S-330MT | 33±20% | 0.850 | 0.650 | 1.20 | 1.40 | 0.70 | 0.86 |
| MAI4020S-470MT | 47±20% | 1.20 | 0.950 | 1.10 | 1.30 | 0.56 | 0.66 |

Note:※1: Rated current: Isat(max.)or Irms(max.),whichever is smaller;

※2: Saturation Current: Max. Value, DC current at which the inductance drops less than 30% from its value without current; Typ. Value, DC current at which the inductance drops 30% from its value without current;

※3: Irms: DC current that causes the temperature rise (ΔT) from 20°C ambient.

For Max. Value, $\Delta T < 40^\circ\text{C}$; for Typ. Value, ΔT is approximate 40°C .

The part temperature (ambient + temp. rise) should not exceed 125°C under worst case operating conditions. Circuit design, component placement, PCB trace size and thickness, airflow and other cooling provisions all affect the part temperature. Part temperature should be verified in the end application.

※4: Absolute maximum voltage: DC 40V

Typical Electrical Characteristics: Please refer to appendix

6. Structure

The structure of MAI4020S product.

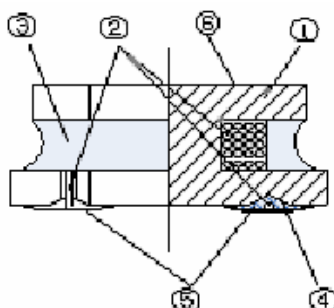

| NO. | Components | Material |
|-----|----------------|--|
| ① | Core | Soft magnetic Metal |
| ② | Wire | Polyurethane system enameled copper wire |
| ③ | Magnetic Glue | Epoxy resin and magnetic powder |
| ④ | Substrate | FeNiCu/Ag |
| ⑤ | Top Electrodes | Sn alloy |
| ⑥ | 无 | |

Specification Sheet for SMD Power Inductor

7. Reliability Test

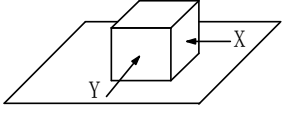
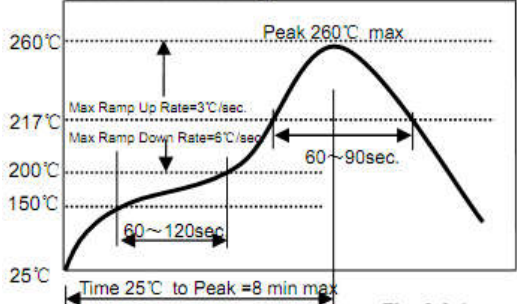
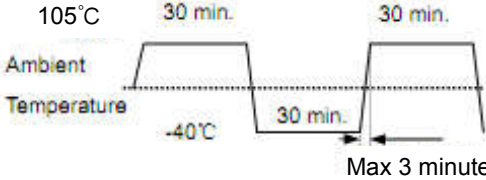
| Items | Requirements | Test Methods and Remarks |
|--|---|---|
| 7.1 Terminal Strength | No removal or split of the termination or other defects shall occur.  Fig.7.1-1 | 1) Solder the inductor to the testing jig (glass epoxy board shown in Fig.7.1-1) using eutectic solder. Then apply a force in the direction of the arrow. 2) 10N force. 3) Keep time: 5±2s |
| 7.2 High Temperature | 1. No visible mechanical damage. 2. Inductance change: Within ±10% | 1) Storage Temperature :125+/-5°C 2) Duration : 96 ±4 Hours 3) Recovery : then measured at room ambient temperature after placing 24 hours. |
| 7.3 Low Temperature | 1. No visible mechanical damage 2. Inductance change: Within ±10% | 1) Temperature and time: -40±5°C 2) Duration: 96±4 hours 3) TRecovery : then measured at room ambient temperature after placing 24 hours. |
| 7.4 Vibration test | 1. No visible mechanical damage. 2. Inductance change: Within ±10% | 1) Frequency range:10HZ~55HZ~10HZ 2) Amplitude:1.5mm p-p 3) Direction:X,Y,Z 4) Time:1 minute/cycle,2hours per axis |
| 7.5 High Temperature Storage Tested | 1. No visible mechanical damage. 2. Inductance change: Within ±10% | 1) Storage Temperature :60+/-2°C 2) Relative Humidity :90-95% RH 3) Duration : 96 ±4 Hours 4) Recovery : then measured at room ambient temperature after placing 24 hours. |
| 7.6 Resistance to Soldering Heat | 1. No visible mechanical damage. 2. Inductance change: Within ±10%  Fig.7.6-1 | 1) Re-flowing Profile: Please refer to Fig.7.6-1 2) Test board thickness: 1.0mm 3) Test board material: glass epoxy resin 4) The chip shall be stabilized at normal condition for 1~2 hours before measuring |
| 7.7 Thermal Shock | 1. No visible mechanical damage. 2. Inductance change: Within ±10%  Fig.7.7-1 | 1) Temperature and time: -40±3°C for 30±3 min→105°C for 30±3min, please refer to Fig.7.7-1. 2) Transforming interval: Max, 3 minute 3) Tested cycle: 100 cycles 4) The chip shall be stabilized at normal condition for 1~2 hours before measuring |

Specification Sheet for SMD Power Inductor

8. Packaging and Marking:

8-1. Carrier Tape Dimensions:

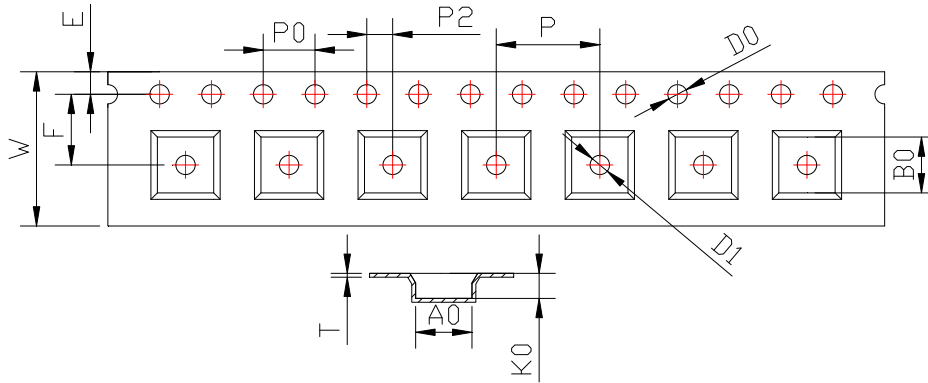

| ITEM | W | A0 | B0 | K0 | P | F | E | D0 | D1 | P0 | P2 | T |
|------|----------------|------|------|------|------|------|------|------|------|------|------|-------|
| DIM | 12.00 | 4.3 | 4.3 | 2.25 | 8.00 | 5.50 | 1.75 | 1.50 | 1.50 | 4.00 | 2.00 | 0.30 |
| TOLE | +0.30 -0.10 | ±0.1 | ±0.1 | ±0.1 | ±0.1 | ±0.1 | ±0.1 | +0.1 | +0.1 | ±0.1 | ±0.1 | ±0.05 |

8-2. Taping Dimensions:

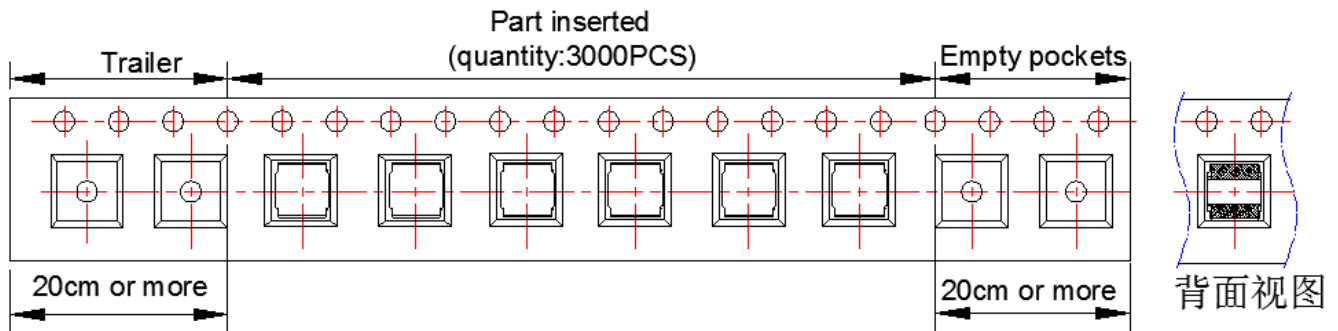

8-3. Reel Dimensions:

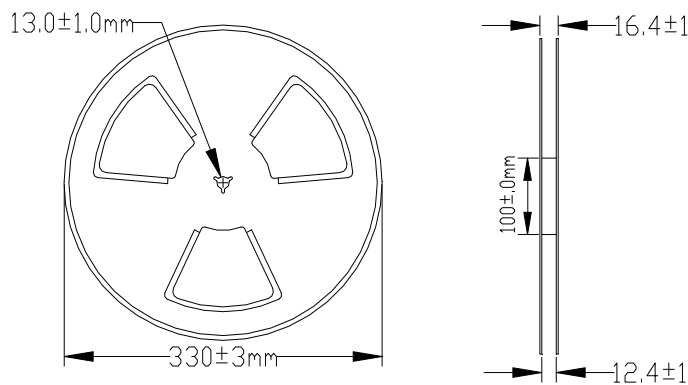

8-4. Packaging Quantity:

3.0KPCS/ Reel 9.0KPCS/ Inner Box 27KPCS/ Outer Box

Specification Sheet for SMD Power Inductor

Visual Inspection Standard of Product

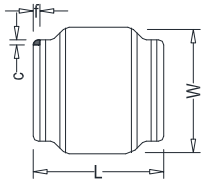
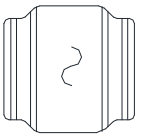
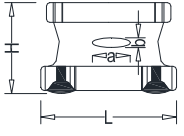
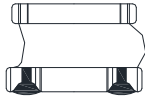
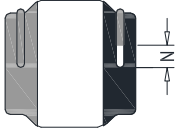
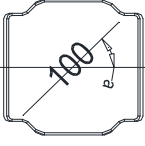
| No. | Defect Item | Figure | Rejection Identification | Acceptance |
|-----|----------------|---|--|------------|
| 1 | Core Defect |  | The defect length(c or f) more than $L/6$ or $W/6$, NG | AQL=0.65 |
| 2 | Core Crack |  | Visual cracks , NG | AQL=0.65 |
| 3 | Starvation |  | (1)Resin starved length a more than $L/2$, NG (2)When $L > 2\text{mm}$, $b > H/2$, NG (3)When $L \leq 2\text{mm}$, b don't control | AQL=0.65 |
| 4 | Excessive glue |  | The length, width or height of product beyond specified value, NG | AQL=0.65 |
| 5 | Cold Solder |  | (1)For CR2520** Series , cold solder $N > 0.5\text{mm}$, NG (2)For other series, cold solder $N > 1\text{mm}$, NG | AQL=0.65 |
| 6 | Marking Defect |  | The marking angle $a > 45^\circ$, NG | AQL=0.65 |

X-ON Electronics

Largest Supplier of Electrical and Electronic Components

Click to view similar products for [Fixed Inductors](#) category:

Click to view products by [Ceaiya](#) manufacturer:

Other Similar products are found below :

[CR32NP-100KC](#) [CR54NP-470LC](#) [70F224AI](#) [MGDQ4-00004-P](#) [MHQ1005P10NJ](#) [MHQ1005P1N0S](#) [MHQ1005P2N4S](#) [MHQ1005P3N6S](#)
[MHQ1005P5N1S](#) [MHQ1005P8N2J](#) [PE-53601NL](#) [PE-53602NL](#) [PG0936.113NLT](#) [9220-20](#) [9310-16](#) [PM06-2N7](#) [PM06-39NJ](#) [A01TK](#)
[1206CS-471XJ](#) [HC2-R47-R](#) [HC8-1R2-R](#) [HCF1305-3R3-R](#) [1206CS-151XG](#) [RCH664NP-140L](#) [RCH664NP-4R7M](#) [RCP1317NP-391L](#)
[RCR110DNP-331L](#) [DH2280-4R7M](#) [DS1608C-106](#) [B10TJ](#) [B82498B3101J000](#) [ELJ-RE27NJF2](#) [1812CS-153XJ](#) [1812CS-183XJ](#) [1812CS-](#)
[223XJ](#) [1812LS-104XJ](#) [1812LS-105XJ](#) [1812LS-124XJ](#) [1812LS-154XJ](#) [1812LS-223XJ](#) [1812LS-224XJ](#) [1812LS-563XJ](#) [1812LS-683XJ](#)
[1812LS-824XJ](#) [NIN-FB101JTR110F](#) [NIN-FB471JTR62F](#) [NIN-FC1R5JTR220F](#) [NIN-HCR15JTRF](#) [NIN-HCR33JTRF](#) [NIN-HDR22JTRF](#)