

Specification Sheet for Approved

Customer Name:	
Customer Part No.:	
Ceaiya Part No:	MTC4010S Series
Spec No:	T4010

【For Customer Approval Only】

If you Approval, Please Stamp

【RoHS Compliant Parts】

Approved By	Checked By	Prepared By
李庆辉	苏高峰	劳水花

Shenzhen Ceaiya Electronics Co., Ltd.

地址 1: 深圳市龙华区观湖街道鹭湖社区观盛二路 5 号捷顺科技中心 B706

地址 2: 东莞清溪镇青滨东路 105 号力合紫荆智能制造中心 10 栋一单元

[Http://www.szceaiya.com](http://www.szceaiya.com)

Tel: 0769-89333213

Specification Sheet for SMD Power Inductor

【Version of Changed Record】

Rev.	Effective Date	Changed Contents	Change Reasons	Approved By
A0	2024-5-23	New release	/	Li qing hui

Specification Sheet for SMD Power Inductor

1. Scope

This specification applies to the MTC4010S Series of wire wound SMD power inductor.

2. Product Description and Identification (Part Number)

1) Description:

MTC4010S series of Wire wound SMD power inductor.

2) Product Identification (Part Number)

MTC 4010 S - 100 M T
 ① ② ③ ④ ⑤ ⑥

① Type	
MTC	Mini Molded Chip Power Inductor

② External Dimensions(L×W×H) 【mm】	
4010	4.0×4.0×1.0

③ Feature type	
S	Standard Product

④ Nominal Inductance	
Example	Example
R47	0.47uH
2R2	2.2uH
100	10uH

⑤ Inductance Tolerance	
N	±30%
M	±20%

⑥ Packing	
T	Tape Carrier Package

3. Electrical Characteristics

Please refer to Item 5.

- 1) Operating temperature range (individual chip without packing): -40°C ~ +125°C (Including Self-heating)
- 2) Storage temperature range (packaging conditions): -10°C ~ +40°C and RH 70% (Max.).

4. Shape and Dimensions (Unit:mm)

Dimensions and recommended PCB pattern for reflow soldering, please see Fig4-1 and Table4-1

Shape and Dimensions:

Recommended pad:

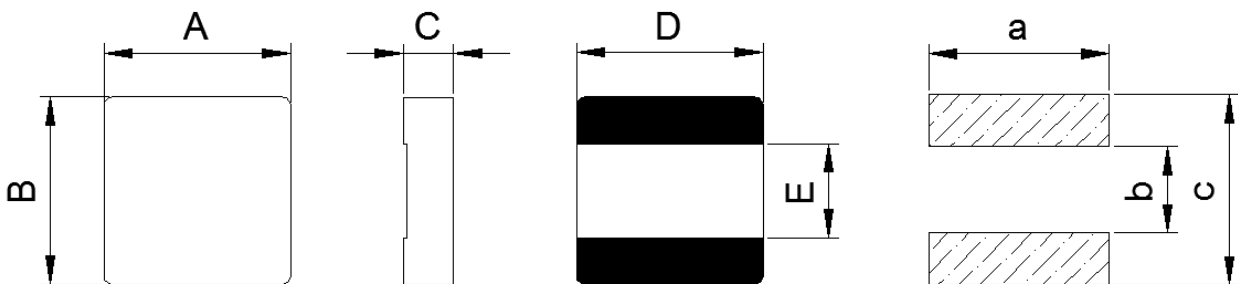

Fig4-1.

Table 4-1.

A	B	C	D	E	a	b	c
4.0±0.2	4.0±0.2	1.05Max	4.0±0.3	1.6±0.3	4.2Ref	1.4 Ref	4.2 Ref

Specification Sheet for SMD Power Inductor

5. Electrical Characteristics

Part Number	Inductance	DC Resistance		Saturation Current		Heat Rating Current	
	1MHz/1V	Max.	Typ.	Max.	Typ.	Max.	Typ.
Units	uH	Ω	Ω	A	A	A	A
Symbol	L	DCR		Isat		Irms	
MTC4010S-4R7MT	$4.7 \pm 20\%$	0.132	0.108	2.80	3.10	2.00	2.30
MTC4010S-100MT	$10 \pm 20\%$	0.342	0.285	2.00	2.50	1.30	1.50

Note:※1: Rated current: Isat(max.)or Irms(max.),whichever is smaller;

※2: Saturation Current: Max. Value, DC current at which the inductance drops less than 30% from its value without current; Typ. Value, DC current at which the inductance drops 30% from its value without current;

※3: Irms: DC current that causes the temperature rise (ΔT) from 20°C ambient.

For Max. Value, $\Delta T < 40^\circ\text{C}$; for Typ. Value, ΔT is approximate 40°C.

The part temperature (ambient + temp. rise) should not exceed 125°C under worst case operating conditions.

Circuit design, component placement, PCB trace size and thickness, airflow and other cooling provisions all affect the part temperature. Part temperature should be verified in the end application.

※4:Absolute maximum voltage:DC 25V

6. Structure

The structure of MTC4010S product.

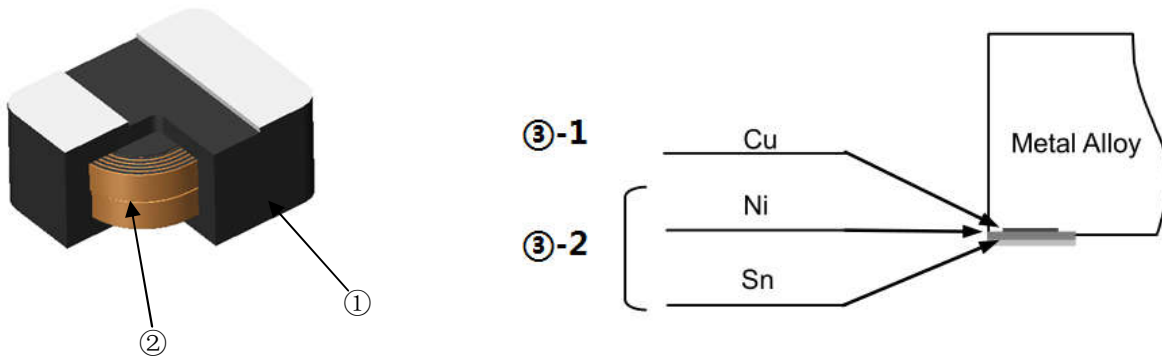

NO.	Components	Material
①	Core	Soft magnetic Metal
②	Wire	Polyurethane system enameled copper wire
③-1	Electrodes	Inside Cu
③-2		Ni+Sn Plating Chemicals

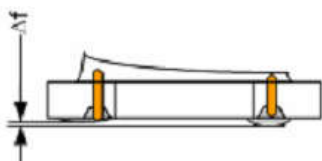

Δf: Clearance between terminal and the surface of plate must be 0.12mm max when coil is placed on a flat plate.

Specification Sheet for SMD Power Inductor

7. Reliability Test

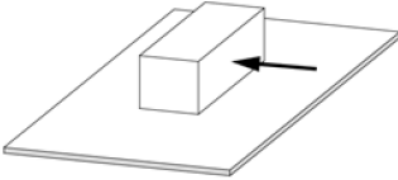
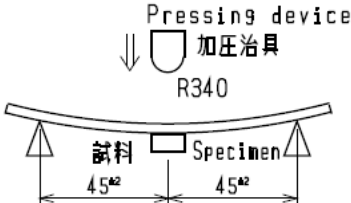
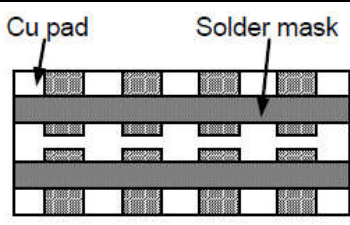
Items	Requirements	Test Methods and Remarks
7.1 Bonding Strength		It shall be soldered on the substrate. Applying Force(F): 10N Hold Duration: 5s 
7.2 Bending Strength	Chip coil shall not be damaged.	Substrate: Glass-epoxy substrate (100×40×1.0mm) Speed of Applying Force: 0.5mm / s Deflection: 2mm Hold Duration: 20s 
7.3 Vibration	No visible mechanical damage. Inductance change: Within $\pm 10\%$  Glass Epoxy Board	1) Solder the inductor to the testing jig (glass epoxy board) using eutectic solder. 2) The inductor shall be subjected to a simple harmonic motion having total amplitude of 1.5mm, the frequency being varied uniformly between the approximate limits of 10 and 55Hz. 3) The frequency range from 10 to 55Hz and return to 10Hz shall be traversed in approximately 1 minute. this motion shall be applied for a period of 2 hours in each 3mutually perpendicular directions (total of 6 hours).
7.4 Solderability	The wetting area of the electrode shall be at least 90% covered with new solder coating.	Flux: Ethanol solution of rosin, 25(wt)% Solder : Sn-3.0Ag-0.5Cu Pre-Heating: 150±10°C / 60 to 90s Solder Temperature: 245±5°C Immersion Time: 3 s
7.5 Resistance to Soldering Heat	Appearance: No damage Inductance Change : within $\pm 10\%$	Reflow soldering method Flux: Ethanol solution of rosin, 25(wt)% Solder: Sn-3.0Ag-0.5Cu Pre-Heating: 150 to 180°C / 60 to 120s Solder Temperature: 230°C min. / 20 to 40s Peak Temperature: 250+5/-0°C Reflow times: 2 times max Test board shall be 0.8 mm thick. Base material shall be glass epoxy resin. Then measured after exposure Standard atmospheric conditions for 1~2h.

Specification Sheet for SMD Power Inductor

7. Reliability Test

Items	Requirements	Test Methods and Remarks
7.6 Heat Resistance	Appearance: No damage Inductance Change : within $\pm 10\%$	Temperature: $125 \pm 2^\circ\text{C}$ Time: 500h ($\pm 12\text{h}$) Then measured after exposure Standard atmospheric conditions for 1~2h.
7.7 Cold Resistance		Temperature: $-40 \pm 2^\circ\text{C}$ Time: 500h ($\pm 12\text{h}$) Then measured after exposure Standard atmospheric conditions for 1~2h.
7.8 Humidity		Temperature: $40 \pm 2^\circ\text{C}$ Humidity: 90 to 95%(RH) Time: 500h ($\pm 12\text{h}$) Then measured after
7.9 Temperature Cycle		1 cycle: 1 step: $-40 \pm 2^\circ\text{C}$ / 30 \pm 3m 2 step: Ordinary temp. / 3m max. 3 step: $+125 \pm 2^\circ\text{C}$ / 30 \pm 3m 4 step: Ordinary temp. / 3m max. Total of 100 cycles Then measured after exposure Standard atmospheric conditions for 1~2h.

Specification Sheet for SMD Power Inductor

8. Packaging and Marking:

8-1. Carrier Tape Dimensions:

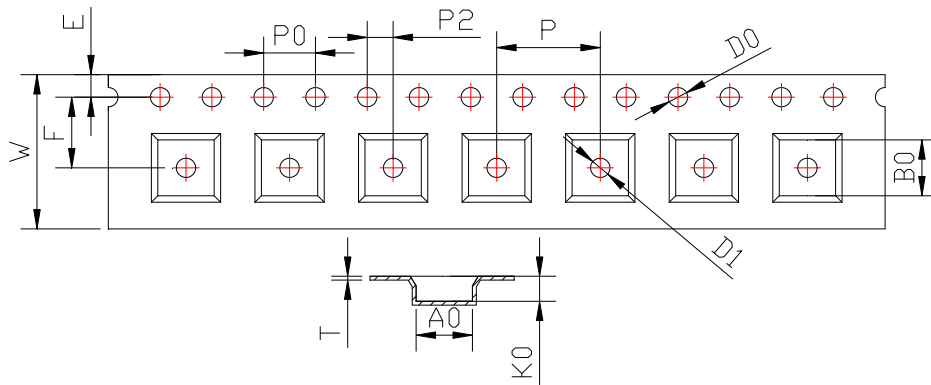

ITEM	W	A0	B0	K0	P	F	E	D0	D1	P0	P2
DIM	12.00	4.3	4.3	1.4	8.00	5.50	1.75	1.50	1.50	4.00	2.00
TOLE	+0.30 -0.10	±0.1	±0.1	±0.1	±0.1	±0.1	±0.1	+0.1	+0.1	±0.1	±0.1

8-2. Taping Dimensions:

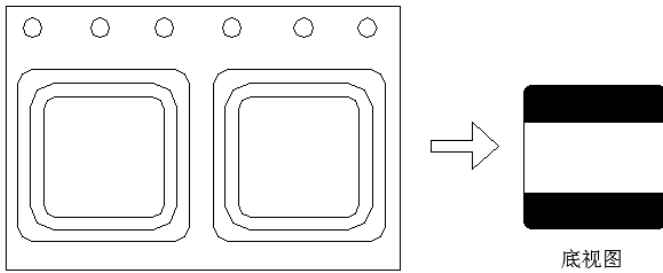

8-3. Reel Dimensions:

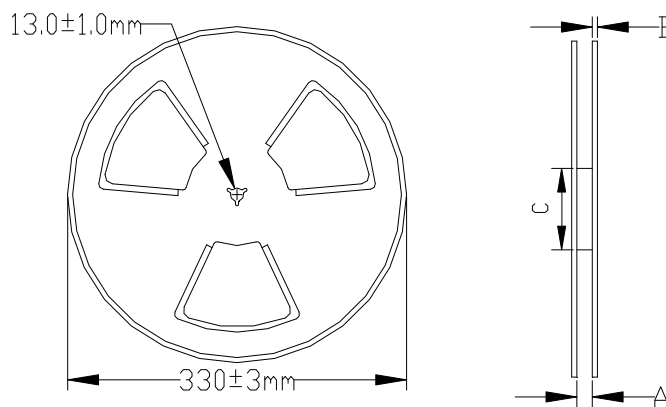

Type	A	B	C
12mm	12.5±1	2.2±1	100±1

8-4. Packaging Quantity:

4.0KPCS/ Reel

X-ON Electronics

Largest Supplier of Electrical and Electronic Components

Click to view similar products for [Fixed Inductors](#) category:

Click to view products by [Ceaiya](#) manufacturer:

Other Similar products are found below :

[CR32NP-100KC](#) [70F224AI](#) [MHQ1005P10NJ](#) [MHQ1005P1N0S](#) [MHQ1005P2N4S](#) [MHQ1005P3N6S](#) [MHQ1005P5N1S](#) [MHQ1005P8N2J](#)
[PE-53601NL](#) [PE-53602NL](#) [PG0936.113NLT](#) [9220-20](#) [9310-16](#) [PM06-2N7](#) [PM06-39NJ](#) [A01TK](#) [1206CS-471XJ](#) [HC2-R47-R](#) [HC8-1R2-R](#)
[HCF1305-3R3-R](#) [1206CS-151XG](#) [RCH664NP-4R7M](#) [RCP1317NP-391L](#) [DH2280-4R7M](#) [DS1608C-106](#) [B10TJ](#) [B82498B3101J000](#) [ELJ-](#)
[RE27NJF2](#) [1812CS-153XJ](#) [1812CS-183XJ](#) [1812CS-223XJ](#) [1812LS-104XJ](#) [1812LS-105XJ](#) [1812LS-124XJ](#) [1812LS-154XJ](#) [1812LS-223XJ](#)
[1812LS-224XJ](#) [1812LS-563XJ](#) [1812LS-683XJ](#) [1812LS-824XJ](#) [NIN-FB101JTR110F](#) [NIN-FB471JTR62F](#) [NIN-FC1R5JTR220F](#) [NIN-](#)
[HCR15JTRF](#) [NIN-HCR33JTRF](#) [NIN-HDR22JTRF](#) [NIN-HDR82JTRF](#) [NIN-HK2N7STRF](#) [NIN-PA150KTR370F](#) [NIN-PB100KTR550F](#)