



CEE NORM

Industrial Plugs and Socket

BS EN.60309-2/BS4343:1992

including

QUICK  CONNECT[®]

RCD Protected Combination Units

Industrial Plugs & Sockets

for harsh conditions & environments

Chemical & Heavy Industry



- R1 S3
- R2 S4
- R3
- R4
- R5
- S1
- S2

Building & Construction Industry



- R1 F11 S3
- R2 F12 S4
- R3 F13
- R4 F14
- F2 F15
- F3 S1
- F9 S2

Military Applications



- R1 F2 F17
- R2 F3 S1
- R3 F7 S2
- R4 F10 S3
- R5 F13 S4
- R6 F15
- F1 F16

Harbour Installation, Containers, Ship Yards & Shipping Lines



- R4 F5
- R5 S1
- R6 S2
- F1 S3
- F2 S4
- F3
- F4

Food Processing & Packaging



- R2 S2
- R3 S3
- R4
- F9
- F16
- F17
- S1

Industrial & Commercial Properties



- R2 S1
- R3 S2
- R4 S3
- F2 S4
- F6
- F8
- F10

Mining & Tunnelling



- R4 F9
- R5 F10
- R6 S1
- F2 S2
- F3 S3
- F6 S4
- F8

Agriculture & Farming



- F2
- F3
- F9
- F13
- F16
- S1
- S3

Power Generation & Distribution



- R1 F2 F12
- R2 F3 F13
- R3 F6 F16
- R4 F7 F17
- R5 F8 S1
- R6 F9 S2
- F1 F10 S3

Camping & Caravanning



- R2 F16
- R4 F17
- R6 S1
- F2 S3
- F4
- F7
- F13

Oil & Gas (Non Hazardous Areas)



- R1 F2 F16
- R2 F3 S1
- R3 F7 S2
- R4 F9 S3
- R5 F10 S4
- R6 F12
- F1 F13

Film, TV & Outdoor Events

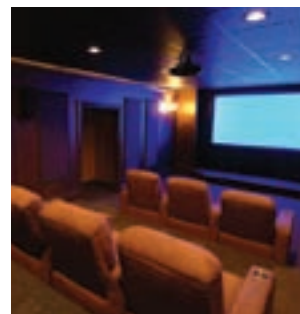

- R1 F2 S1
- R2 F4 S2
- R3 F7 S3
- R4 F9 S4
- R5 F13
- R6 F16
- F1 F17

Contents

With Resistance to

- R1** Light acids
- R2** Oil
- R3** Grease
- R4** Solvents
- R5** Aggressive gases & vapours
- R6** Resistant against seawater

Standard Features

- F1** High mechanical strength
- F2** Nickel-plated contacts
- F3** High temperature resistant contact carrier
- F4** Modular set-up
- F5** Components can be changed separately
- F6** Box terminals
- F7** Special design ensures a good grip
- F8** Cable entry big enough for rubber insulated cable
- F9** Protected against corrosion
- F10** Flame retardant
- F11** Kontex-Plus & box terminals (for 63 & 125A)
- F12** Breaking capacity test (63A at 690V)
- F13** All outside metal parts are made of stainless steel
- F14** Reinforced fixing of hinged cover, movable above 180°
- F15** Special thread of cable gland ensures high torque
- F16** Socket-outlets & connectors (couplers) in IP44, IP55 & IP67 available
- F17** Transparent operating window with 'Click-Fast' facility

Special Features

- S1** QUICK CONNECT®
- S2** Screw terminal
- S3** Combination units
- S4** Metal high current

Introduction & features

Screw Terminal Connections & product features	4
Quick-Connect - The new generation	6
Multi-Grip - Positive cable clamping	8
Production, quality assurance and approvals	10
Method of connection & selection etc	14

Product information

Socket Outlets	19
Switched Interlocked Sockets	31
Plugs & Appliance Inlets	37
Connectors (couplers)	53
Quick-Connect	61
Low Voltage	75
Refrigerated (reefer) Container Plugs & Sockets	83
Special Purpose Products	89
500V black/green high frequency	92
Direct current plugs & sockets	93
7 Pole (6P + E) plugs & sockets	94
Phase Inverters	99
Schuko Plugs & Sockets	105
Combination Units	109
Pre-wired units (16, 32 & 63A)	114
Multi-outlet units	117
Switch interlocked units (16,32 63A)	118
Pre-wired units (125A)	120
Switch interlocked units (125A)	121
Single & multi outlet socket units	122
Heavy duty rubber in-line units	125
Multi-outlet distribution units	126
Earth monitoring units	127
Made to order units	128
Specialist Applications & Accessories	131
Caravan hook-up units & accessories	132
Garage 'utility' units & shower units	135
Film - TV & events distribution equipment	136
Enclosure windows	138
Military Applications	139
Product Code Index	141

Screw-terminal Connections

63A & 125A

The CEE Norm U.K. range of industrial plugs & sockets is one of the most technically advanced & comprehensive range available which conforms to BS EN. 60309-2/BS4343:1992 & IEC 309-1/2.

The use of high quality materials in their manufacture gives the CEE Norm U.K. range such advantages as:

High impact strength

Resistance to sudden changes in temperature

Resistance to wear

High insulation resistance

Generally good resistance to most chemicals

Backed by more than 45 years of manufacturing experience, the products have developed into a quality 'user friendly' range.

CEE Norm U.K. also manufacture a full range of RCD/MCB combination units & multi-outlet distribution units.

The majority of items in this catalogue are available ex-stock or on fast delivery.

Please do not hesitate to contact our sales office for further details.

01952 212 700

QUICK-CONNECT range see pages 6-7

Multi-Grip products see pages 8-9

Designed For Safety & Reliability In Use



All pins, sleeves, screws, contact springs and terminals are either nickel plated or manufactured from rustproof materials to ensure corrosion resistance.

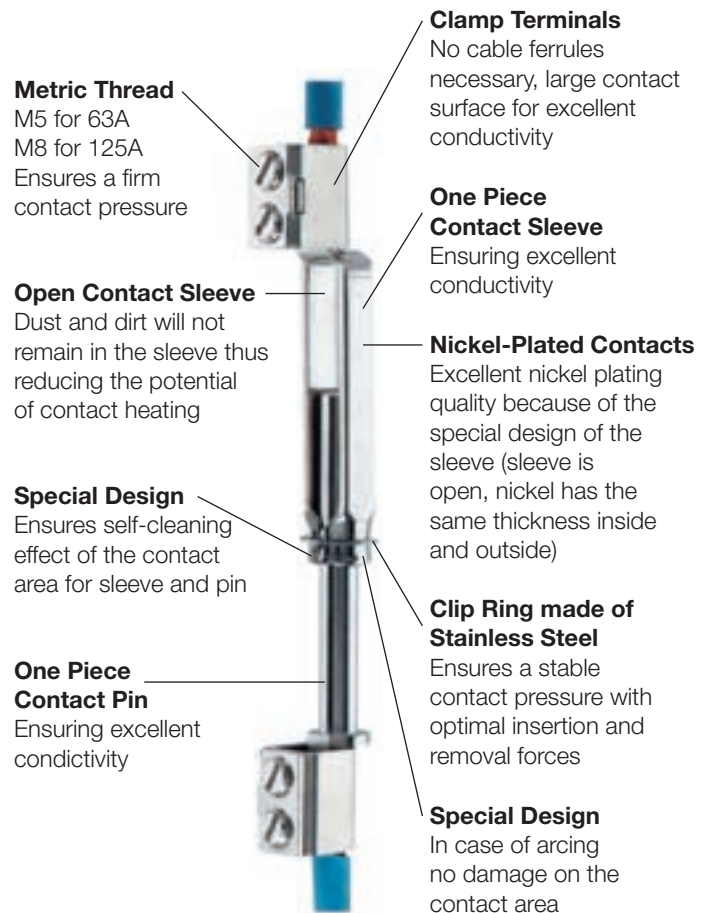

Typical quality features

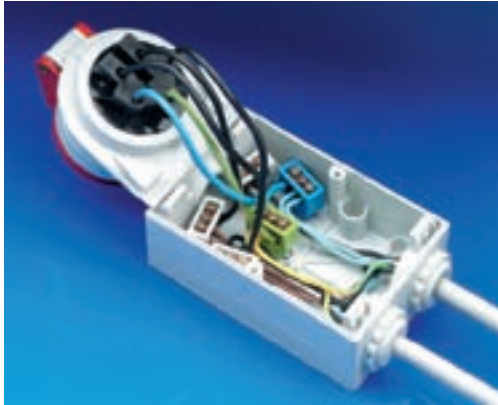

- Socket outlet with through wiring facilities
- Large connection area
- Cable entries at top and bottom
- Contact carrier can be pushed in base of enclosure rotating by 180°

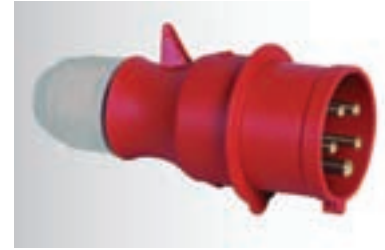

- One piece body with Multi-Grip cable gland
- Screw terminals
- 16A - 32A plugs and connectors
- IP44



- Temperature resistant contact carrier cable entry up to 36.5mm for 63A, up to 50mm for 125A
- Nickel-plated clamp terminals for 63 and 125A
- Takes large cable diameters
- No need for cable ferrules
- Defined contact pressure
- Excellent conductivity



- All SCHUKO-type plugs and sockets are available in splashproof as well as watertight versions
- Ergonomic design ensures a good grip and easy handling



- New interlocking mechanism
- Compact design
- Top and bottom cable entry
- High quality switch mounted on DIN-rail
- 63A and 125A with Kontex-Plus and clamp terminals
- No maintenance of the interlocking mechanism necessary
- IP44 and IP67



- Large connection area enables wiring with up to 70mm² conductors
- Neutral and earth contacts are already pre-wired



- Hinged cover opens from front and reduces potential for accumulation of dust and moisture inside cover

Surface Mounting and Panel Mounting Sockets
Safe, Solid, Time-Saving

QUICK CONNECT[®]

the new generation

with cage clamp terminals



Cage Clamp Terminals

- Easy and quick to handle
- Terminals in the open position on delivery
- Push down the appropriate contact slide to lock the conductor into the terminal
- To re-open, use a screwdriver blade to lift the contact slide

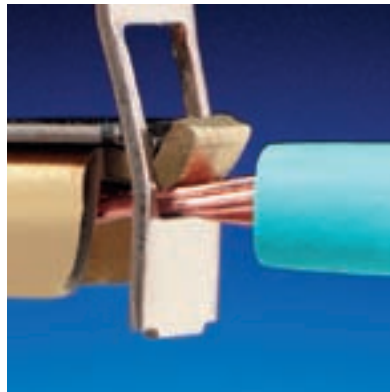

Screwless Cage Clamp Terminals

- Special contact technique
- 4-point (quarter turn) locking system to close the 2 piece enclosure without screws
- Moulded cable sleeve or Multi-Grip cable gland
- Halogen, cadmium, silicon and PVC free plastics

Screwless cage clamp terminals

- Maintenance free after installation
- Shock and vibration resistant
- Push-type terminals without the need of cable ferrules for the conductor or the use of crimping tools

KONTEx-PLUS-Contact:

- Approved breaking capacity
- Self-cleaning
- Corrosion free spring
- Low and stable removal and withdrawal forces
- Positive conductivity
- Higher percentage of copper guarantees better conductivity and low temperature rise



The push-type terminal is supplied **with the cage clamp in the open position.**

These cage clamps have proved their reliability millions of times and are maintenance-free. The cage clamp is closed through a special contact slide and can be opened easily by lifting the slide with the help of a screwdriver.

QUICK CONNECT[®]

the better alternative to screw type terminals
16A & 32A



Simply open

Cage clamp terminals

The cage clamp terminals are open on delivery so that the stripped conductor with or without cable end ferrules can immediately be inserted. The terminals accept conductors from 1 up to 4 mm for 16A and 2,5 up to 10 mm for 32A products. They have proven their reliability millions of times since they have been introduced.



Simply insert

Conductors

The cage clamp terminals accept the same conductor size or type of cable as the relevant 'screw type' terminals. Solid or stranded wires with or without cable end ferrules can easily be inserted.



Simply "click"

Push slide

The inserted conductor is locked damage free and with optimal contact by simple fingertip pressure onto the terminal. The push slide is colour coded for ease of wiring and can be reopened by simply pulling it back with a normal blade screw driver.



Simply quick

Wiring

The unique, time and labour saving quick connect products are patented world wide. They are CE approved completely fulfilling all the requirements of IEC 309 regulations. With this fine connection technique the wiring of a CEE-product is really easy and guarantees good wiring quality even under difficult conditions.

Examples of the most popular conductors:



Stranded



Solid



Stranded with ferrule crimped on airtight

Multi-Grip features

from 16A to 125A

Quicker, better, more reliable



Simply safe

Special screw fitting

The special threaded fitting is secured with a saw tooth thread, which prevents self-induced and unintentional loosening, while plugging and unplugging the connector. The working surface of the threaded fitting is amply dimensioned for commercially available spanners.



Simply dry

Drainage opening

Water will no longer remain in the flared opening; instead it is removed through the drainage holes. Water is absolutely prevented from entering the inner connection space, even when the cable is moved.



Simply secure

Lamella effect

18 flexible fins adapt themselves to the thinnest or thickest cable diameters, when the threaded fitting is tightened. They guarantee optimal strain relief, while at the same time protecting the cable. The tensile strength exceeds by far the values required by the standards IEC 60309, EN 60309 and VDE 0623.



Simple to close

Rubber seal

When firmly fastened, permanent rubber seal enables the connection to be simplified. In the event of a proper installation, class IP67 protection will be achieved.

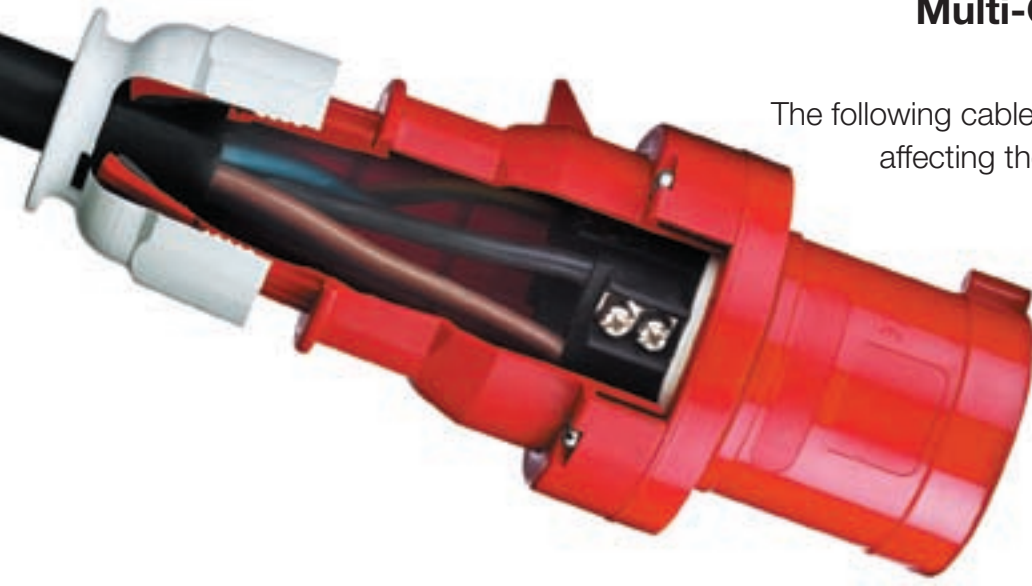

Multi-Grip adapts effortlessly to cable diameters!

The following cable diameters can be inserted, without affecting the closure or capacity for strain relief.

Connector	Cable diameter (mm)
16A 3 - 4 pins	8 - 18
16A 5 pins	10 - 21
32A 3 - 4 pins	11 - 23.5
32A 5 pins	13 - 27
63A 3 - 5 pins	16 - 36
125A 3 - 5 pins	26 - 50

Further valuable time saved in making connections

Time saving with:

- 32A 5 pin: = 52%
- 63A 5 pin: = 42%

Multi-Grip

Multi-Grip

a better answer to 'old style' cable glands



Rubber reducing rings and internal strain relief systems are no longer needed.
 Increased internal wiring space.
 Easier and faster wiring becomes possible.

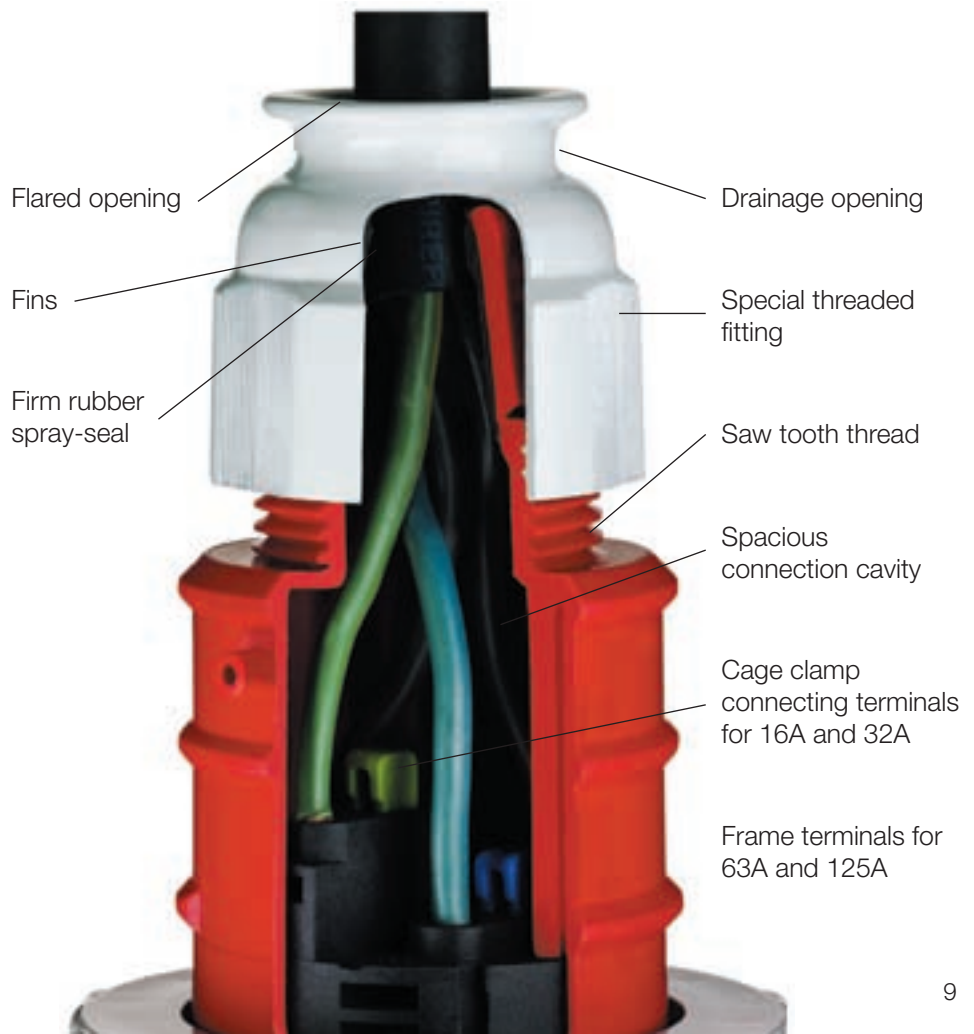

NO LONGER NEEDED



The design department has the most modern hardware and software at its disposal

Development and Construction

The many and varied demands on specification and function of electrical connectors, which are made for the world-wide market, are continuously analysed and transformed into new types of products within the shortest period of time.

'Form follows function' is the maxim of our designers and engineers whose experience and expertise benefits customers. This approach led to the slogan 'Quality that convinces!', which includes being safe, robust, and installation friendly as primary characteristics.

Production and assembly facilities at the factories in Germany and Telford



Machine tool islands that are planned down to the smallest detail permit a quick and flexible assembly of both series and special orders

Excellently trained tool makers, using CNC controlled machine tools, quickly realize the ideas that are presented by engineers and designers

Production

The wishes of the customer are the focus of all our activities. Speed is imperative, and various teams in the production departments are specially trained to meet these demands. Continuing and advanced training of the personnel, in combination with our flexible range of automated machines, assures that even production peaks remain manageable.

Fully automated manufacturing cells for brass contacts increase both the quality and quantity of the manufactured output

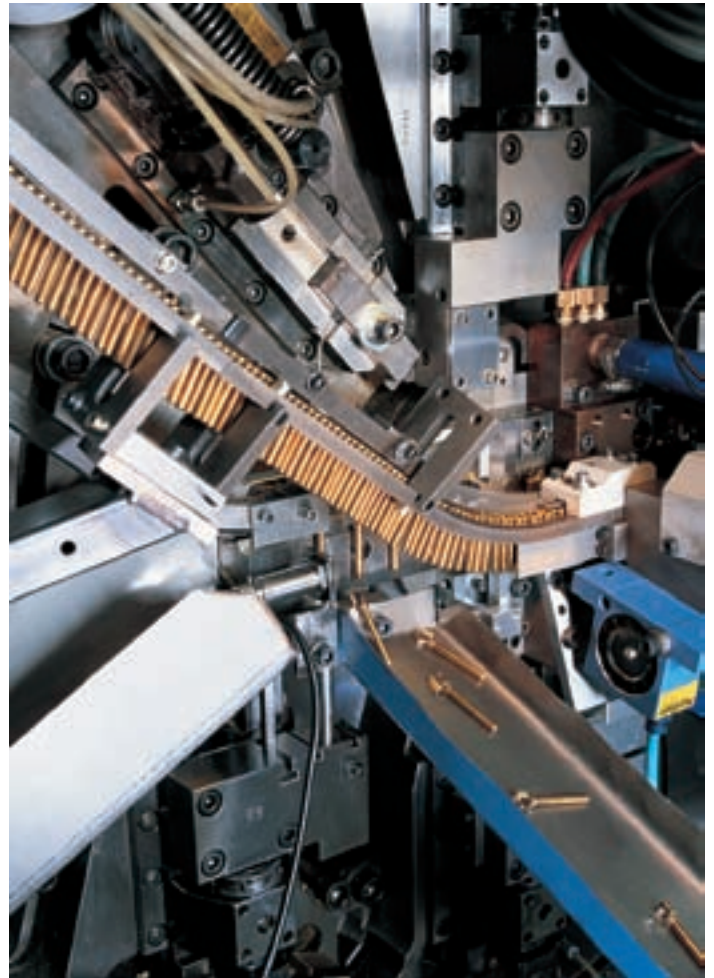

All plastic parts are manufactured with the most modern plastic injection moulding machines, which deliver constant quality

Well-trained and highly skilled specialists guarantee observance of the required safety guidelines, during the assembly and wiring of outlet modules





Testing and Quality Assurance

Our products are subjected to endurance tests, which are designed to exceed the harshest reality.

All our parts are tested with glowing heat and freezing cold, extreme humidity and water, together with the finest dust and the roughest dirt.

The most modern measuring and testing equipment is used to maintain our high standard of quality

Only materials of the best quality, such as rust free contact springs, nickelplated brass clamps or glass-fibre reinforced contact carriers are used on our products.

Products are not released from our factories until all these tests have been passed.



All our connector devices are tested, to make sure that they are watertight and dustproof to meet the relevant IP rating





Only plastics that pass the heating wire test are released for use in our products



Continuous testing of all the production steps, in accordance with the strictest testing plans, guarantee quality. The result of these measures is a continuous improvement in quality, at all levels of our company.

The national and international certificates of leading test institutes are a visible substantiation of the success of this policy

Approvals

In order to promote mutual recognition of test certificates for the acquisition of national test marks, and to reduce the workload in the various testing agencies, an approval procedure for obtaining a CCA certificate has been created through the CENELEC certification agreement.

Thus after positive completion of testing through the national testing agency, an application can be made for a CCA certificate, which leads to direct approval in the CENELEC member countries.

Within the area in which the EC low voltage directives apply, it is not permitted to demand test marks. Above all when the recognised mark of an individual country has been attained, the product in question has a claim to free movement of goods in all EC countries.

Testing Certificates



All injection moulded parts are subjected to tensile strength and pressure tests

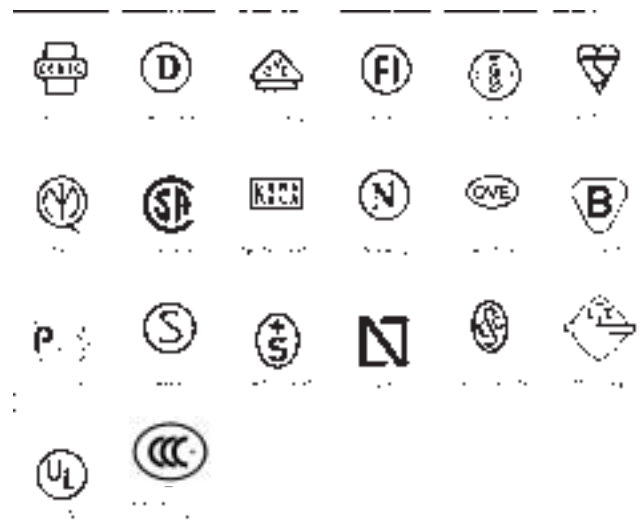

Sequence of Connection

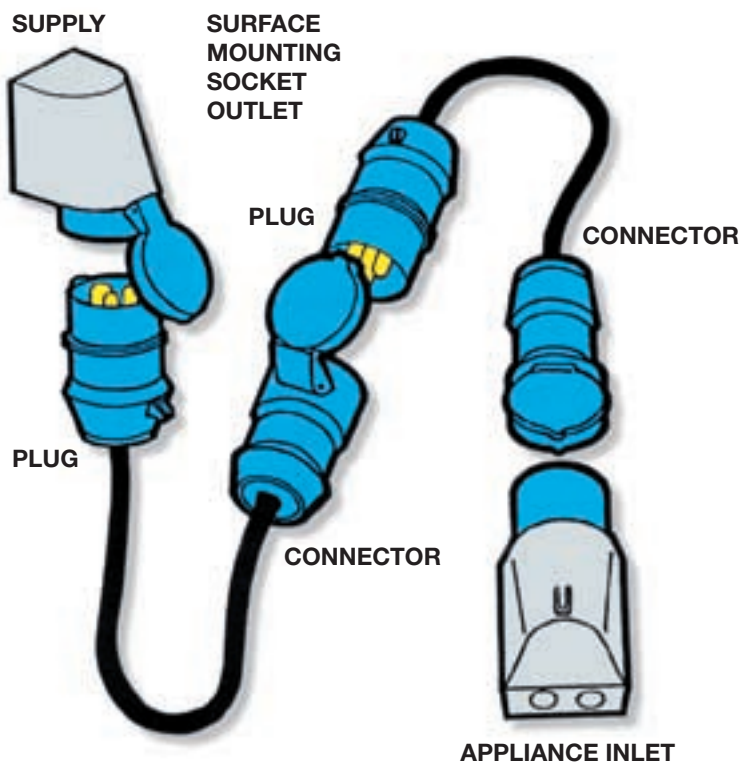

Abbreviations used in this Catalogue

Current	A
Voltage	V
Frequency	Hz
Alternating Current	~
Direct Current	—
Splashproof IP44	IP44
Watertight IP67	IP67
Poles	P
Earth	E
Neutral	N
Pilot Pins	P
Greater Than	>
Up To or Less Than	≤

CEE Norm U.K. offers a proven range from the simplest 16A 110V 2P+E plug to multi-outlet socket units with a variety of protection.

If you cannot find your exact requirements in this catalogue, please do not hesitate to contact our sales department for guidance.

Tel: 01952 212 700

Continuous Innovation such as the QUICK-CONNECT system for 16A and 32A plugs and sockets which has screwless terminal connections saving installation time.

The plug and connector bodies are securely closed without the use of screws and opened with one twist of a screwdriver.

The design complies with EN60309/1+2 and are certified and permitted to carry the VDE test mark.

NEW!

63A 415V 4P and 5P surface sockets, plugs and connectors now available in

QUICK  CONNECT[®]

The Cee Norm Range: Safety, Quality, User Friendly

- **Comprehensive**
- **Competitive**
- **Available**

Safety Standards

The need for a common international standard for industrial plugs and sockets has long been obvious not only from the point of view of safety but also for compatibility between manufacturers. The U.K. standard BS4343 (published 1968) for industrial plugs and sockets was based on the European and International standards CEE 17 and IEC 309.

The advantages of the BS4343 system soon established it as the safest and most reliable for industrial plugs and sockets in all areas of industry. However, harmonisation of standards with the European Community members has led to CENELEC (The European Committee for Electrotechnical Standardisation) developing a unified standard for industrial plugs and sockets EN60309-1 and 2. This has led to a revision of the U.K. standard BS EN60309-21BS4343:1992. The CEE Norm U.K. range fully conforms to all the aforementioned standards and is therefore also compatible with other manufacturer's equipment to the same standards.

CE Marking





All products comply with the CE Marking directive where applicable.

IP (Ingress Protection) Ratings

The CEE Norm U.K. range offers a choice of IP44 (splashproof) or IP67 (watertight) for most products.

The exceptions are:- All 125A products are IP67. All Extra Low Voltage (50V or less) products are available at IP44 only.

The table below is a general guide only to the meaning of the IP numbers. In all cases correct installation and connection is assumed.

First Numeral		Second Numeral	
(a) Protection of persons against contact with live or moving parts inside enclosure. (b) Protection of equipment against ingress of solid bodies.		Protection of equipment against ingress of liquid.	
Number/ Symbol	Degree of Protection	Number/ Symbol	Degree of Protection
4	(a) Protection against contact by tools, wires or the like, more than 1.0mm thick. (b) Protection against ingress of small foreign bodies.	4 	Splash Proof:- Liquid splashed from any direction shall have no harmful effect.
5 	(a) Complete protection against contact. (b) Dust Proof:- Protection against harmful deposits of dust, dust may enter but not in amounts sufficient to interfere with satisfactory operation.	5 	Jet Proof:- Water projected by a nozzle from any direction (under stated conditions) shall have no harmful effect.
6 	(a) Complete protection against contact. (b) Dust Tight:- Protection against ingress of dust.	7 	Protection Against Immersion in Water:- It shall not be possible for water to enter the enclosure under stated conditions of pressure and time.

Colour Coding

All CEE Norm products are colour coded in compliance with BS EN. 60309-2/BS4343:1992 and IEC309 (see table below) for ease of identification of the various voltages and frequencies.

Voltage or Frequency	Colour Code
20 - 25V (24V)	Violet
40 - 50V (42V)	White
100 - 130V (110V)	Yellow
200 - 250V (240V)	Blue
380 - 480V (415V)	Red
500 - 690V (500V)	Black
60 - 500Hz	Green

Note:

We have used the 'trade standard' voltages of 24V, 42V, 110V, 240V, 415V and 500V on the part number pages in this catalogue. The actual voltage range for each type is as per British standards and international regulations.

For convenience, the 415V (red) appliance has been shown throughout this catalogue for most products. Other voltages / frequencies are also available (where indicated) in the appropriate colours indicated alongside.

Earth 'Clock' Position

To prevent the possibility of connecting items of different voltages or frequencies with one another by mistake, the earth tube (or pin) position is designated in accordance with the voltage or frequencies in such a way to make this impossible.

The earth (or H) position is determined by looking into a socket from the front, with the keyway at the bottom 6 o'clock (6H) position.

The various earth clock positions are as per the diagram on the next page.

Note: It follows that on products with pins i.e. plugs and appliance inlets, the earth pin is reversed so that it fits into the correct earth tube position socket.

For **extra low voltage** products, the position is that of the minor keyway in relation to that of major keyway at the 6 o'clock position of the socket. Again on products with pins, the position of the minor keyway appears reversed to allow it to slot into the socket.

>50V

Viewed from front of Socket

<50V

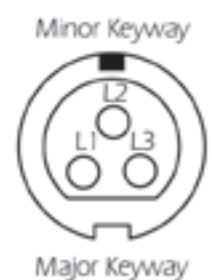
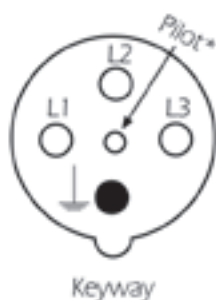

* Pilot is only fitted on 63A and 125A items

Earth 'Clock' Position on over 50V Equipment

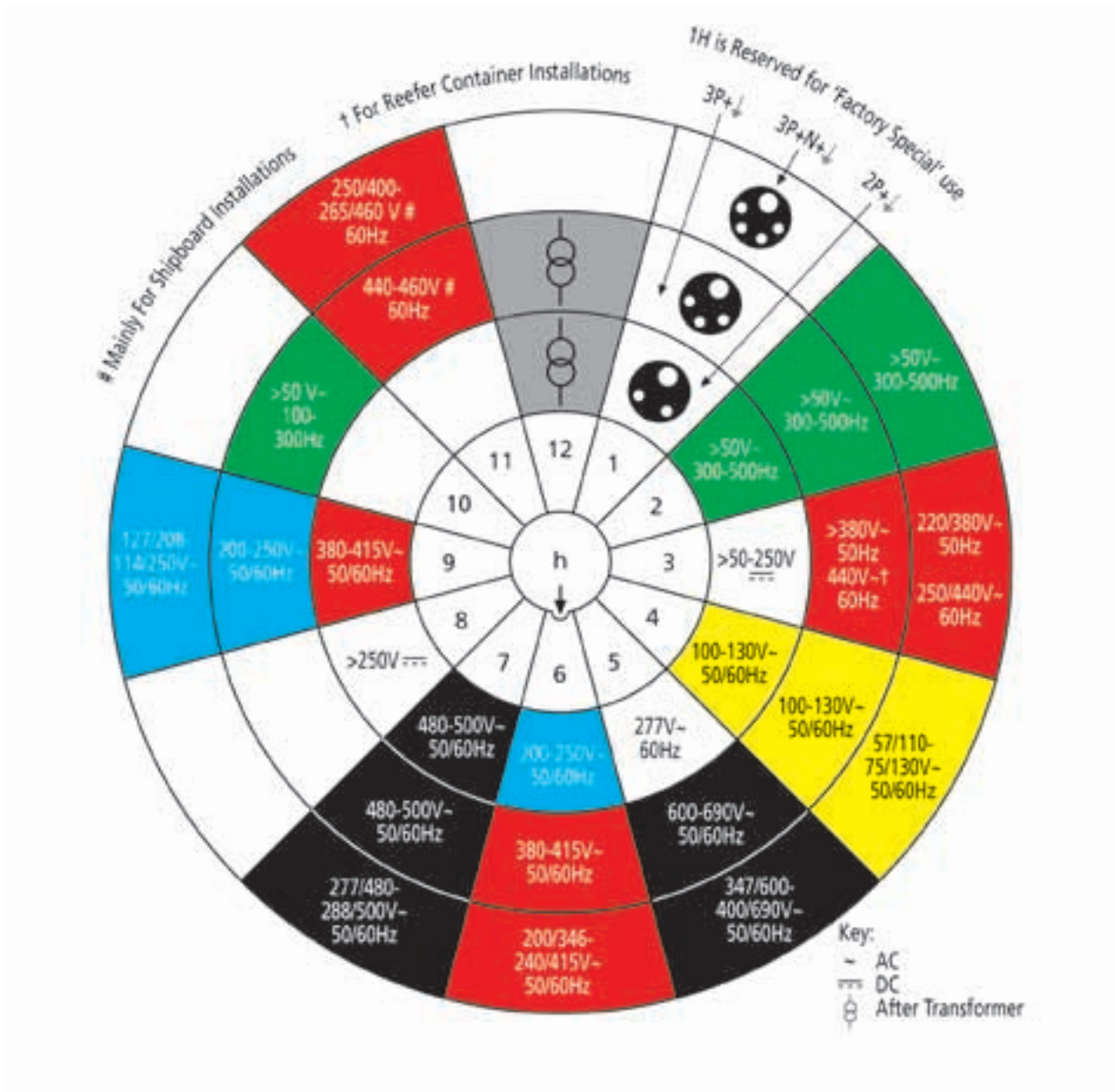

Minor keyway position in relation to the major keyway (at 6H) on extra low voltage (less than 50V) equipment (looking at socket)

Number of Poles	Frequency Hz	Voltage	Minor Keyway Position
2 or 3	50/60	20 -25	None
2 or 3	50/60	40 - 50	12h
2 or 3	100 - 200	40 -50	4h
2 or 3	300	20 -25 40 - 50	2h
2 or 3	400	20 -25 40 - 50	3h
2 or 3	> 400 - 500	20 -25 40 - 50	11h
2 or 3	Direct Current	< 50	10h

Notes:

Socket Outlets



Surface Mounting Socket Outlets

page 22

Panel Mounting Socket Outlets

page 26

Chemical and Heavy Industry



Harbour installation containers, ship yards and shipping lines

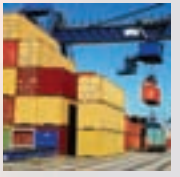

Mining and tunnelling

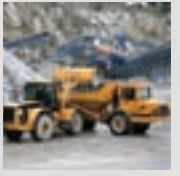

Camping and caravanning



Building and construction industry



Food processing and packaging

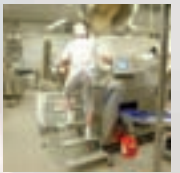

Agriculture and farming

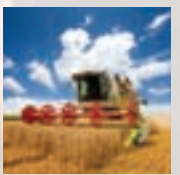

Military applications



Industrial and commercial properties



Power generation and distribution

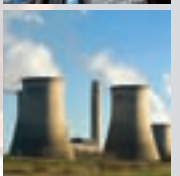

Oil and gas (non hazardous areas)

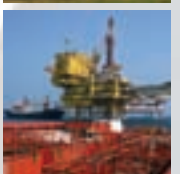

Film, TV and outdoor events

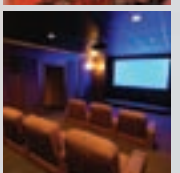

Surface and Panel Mounting Socket Outlets



- Heat-resistant contact carrier
- Screw/clamp terminals for 63A and 125A
- Problem-free wiring, even in the case of connection from below
- Lower housing part can be rotated around 180°
- Easily accessible connecting terminals

- QUICK-CONNECT cage clamp tension spring technology for 16A and 32A or normal screw terminals
- Brass-nickel-plated clamp terminals for 63A and 125A
- Accommodation of large lead cross-sections
- Even contact pressure with minimised transition resistance

- KONTEx-PLUS, new contact sleeve, protected by utility model
- Outstanding contact rating results (16A, 32A, 63A/690V)
- Self-cleaning
- Defined contact operation
- Almost unchanging with drawing forces
- Excellent heat dissipation
- Good current flow through high copper content
- Contact spring of non-corroding material



Safe, Robust, Easy to Install

This Section Refers to Screw Terminal Products Only

16A and 32A sockets are available with either screw terminals or **QUICK CONNECT**® terminals.

63A and 125A sockets are available with screw / clamp terminals.



63A 415V 4 pin and 5 pin surface sockets are now also available with **QUICK CONNECT**® terminals.



Refer to Pages 63 - 73
for **QUICK CONNECT**®
Offering Time Saving
Installation and Assembly



Socket Outlets

16 	110	50 - 60	11302	4	113	4	1110	4
	240	50 - 60	11304	6	114	9	1111	9
	415	50 - 60	112	9	11306	6	11308	6
32 	110	50 - 60	11310	4	1116	4	1122	4
	240	50 - 60	11312	6	1117	9	1123	9
	415	50 - 60	1115	9	11314	6	11316	6
63 	110	50 - 60	1106	4	1125	4	1129	4
	240	50 - 60	1104	6	1126	9	1130	9
	415	50 - 60	1107	9	1127	6	1124	6



Surface Mounting Socket Outlet

Top & Bottom Cable Entry

 Splashproof

16A = M20

32A = M25

63A = M40 Top / M32 Bottom

16A and 32A with screw terminals

63A with screw / clamp terminals and pilot contact

Note: This pilot contact should **NOT** be counted as a main 'pin'

16 	110	50 - 60	11303	4	1135	4	1141	4
	240	50 - 60	11305	6	1136	9	1142	9
	415	50 - 60	1134	9	11307	6	11309	6
32 	110	50 - 60	11311	4	1147	4	1153	4
	240	50 - 60	11313	6	1148	9	1154	9
	415	50 - 60	1146	9	11315	6	11317	6
63 	110	50 - 60	1156	4	1159	4	1163	4
	240	50 - 60	1157	6	1160	9	1164	9
	415	50 - 60	1158	9	1161	6	1112	6



Surface Mounting Socket Outlet

Top & Bottom Cable Entry

 Watertight

16A = M20

32A = M25

63A = M40 Top / M32 Bottom

16A and 32A with screw terminals

63A with screw / clamp terminals and pilot contact

Note: This pilot contact should **NOT** be counted as a main 'pin'

Dimensions

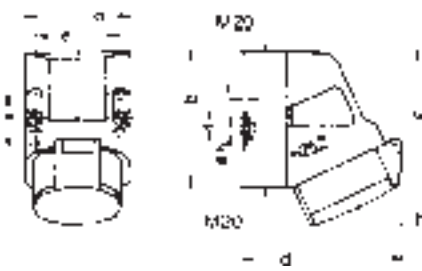

Amperes	16		
Poles	3	4	5
a	64	75	75
b	87	100	100
c	117	129	131
d	103	108	116
e	51	59	59
f	-	11	11
h	4.1	5.1	5.1
i	4.5	4.5	4.5
k	40	-	-
Conductor mm ² min	1.5	1.5	1.5
Conductor mm ² max	4	4	4

Surface Mounting Socket Outlet

Cable entry one at top (open), one at bottom and on the back (closed) base of enclosure can rotate by 180°

 Splashproof



Amperes	32		
Poles	3	4	5
a	83	83	83
b	126	126	126
c	155	155	155
d	130	130	136
e	68	68	68
f	11	11	11
ø h	5.5	5.5	5.5
i	6.5	6.5	6.5
ø k	12	12	12
l	65	65	65
m	80	80	80
ø n	10	10	10
Conductor mm ² min	2.5	2.5	2.5
Conductor mm ² max	10	10	10

Surface Mounting Socket Outlet

Cable entry one at top (open), two at bottom and one on the back (closed) base of enclosure can rotate 180° drill holes prestamped in the base of the enclosure

 Splashproof

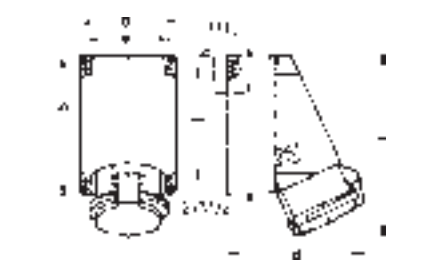

Amperes	63		
Poles	3	4	5
a	118	118	118
b	170	170	170
c	223	223	223
d	168	168	168
e	104	104	104
f	136	136	136
ø h	6.1	6.1	6.1
i	6	6	6
Conductor mm ² min	6	6	6
Conductor mm ² max	25	25	25

Surface Mounting Socket Outlet

Temperature resistant contact carrier, cable entry one at top (open) and two at bottom (closed)

 Splashproof

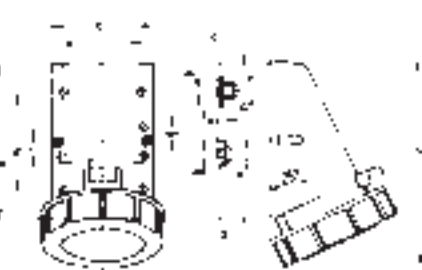

Amperes	16			32		
	3	4	5	3	4	5
a	64	75	75	83	83	83
b	87	100	100	126	126	126
c	115	130	130	160	160	160
d	103	110	115	129	129	135
e	51	59	59	68	68	68
f	20	11	11	11	11	11
g	20	-	-	-	-	-
ø h	4.1	5.1	5.1	5.5	5.5	5.5
i	4.5	4.5	4.5	6.5	6.5	6.5
ø k	8	10	10	12	12	12
l	-	-	-	65	65	65
m	-	-	-	80	80	80
ø n	-	-	-	10	10	10
o	M20	M20	M20	M25	M25	M25
p	M20	M20	M20	2xM25	2xM25	2xM25
Conductor mm ² min	1.5	1.5	1.5	2.5	2.5	2.5
Conductor mm ² max	4	4	4	10	10	10

Surface Mounting Socket Outlet

Cable entry one at top (open), one at bottom at 16 Amp and two at 32 Amp (Closed)

 Watertight

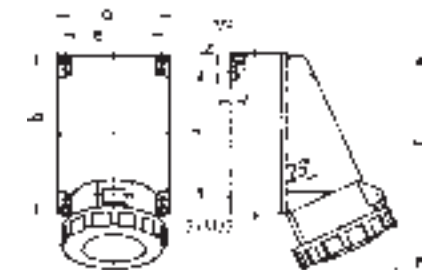



Amperes	63		
Poles	3	4	5
a	118	118	118
b	170	170	170
c	228	228	228
d	176	176	176
e	104	104	104
f	136	136	136
ø h	6.1	6.1	6.1
i	6	6	6
Conductor mm ² min	6	6	6
Conductor mm ² max	25	25	25

Surface Mounting Socket Outlet

Temperature resistant contact carrier cable entry one at top (open) and two at bottom (closed)

 Watertight

A CURRENT	V VOLTAGE	Hz FREQUENCY	 2P+E	EARTH HR. POS	 3P+E	EARTH HR. POS	 3P+N+E	EARTH HR. POS
--------------	--------------	-----------------	---	---------------------	---	---------------------	---	---------------------

Socket Outlets



125 	110	50 - 60	11436	4	11439	4	11445	4
	240	50 - 60	11437	6	11440	9	11446	9
	415	50 - 60	11438	9	11441	6	11447	6

125A with screw / clamp terminals and pilot contact

Note: This pilot contact should **NOT** be counted as a main 'pin'



Surface Mounting Socket Outlet

Top M50 Cable Entry

 Watertight

125 	110	50 - 60		4		4		4
	240	50 - 60	11476	6		9		9
	415	50 - 60		9	11477	6	11479	6

125A with screw / clamp terminals and pilot contact

Note: This pilot contact should **NOT** be counted as a main 'pin'





Surface Mounting Socket Outlet

Top M40 Cable Entry

Bottom 1x M40/M50

 Watertight



16 	240	50 - 60	1183	6				9
	415	50 - 60		9			1186	6
32 	415	50 - 60					11190	6

16A and 32A with screw terminals



Surface Mounting Socket Outlet

 Splashproof

16 	240	50 - 60	13105	6				9
	415	50 - 60					13108	6
32 	415	50 - 60					13146	6

16A and 32A with screw terminals



Panel Mounting Socket Outlet

 Splashproof

Suitable for commercial / laboratory type applications

Other voltages and frequencies are available on request. Contact CEE Norm UK for further details

Dimensions

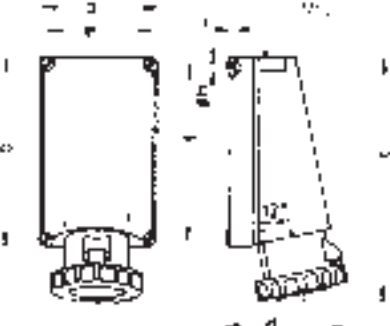

	Amperes		
	3	4	5
Poles	3	4	5
a	160	160	160
b	260	260	260
c	330	330	330
d	168	168	168
e	140	140	140
f	240	240	240
ø h	8.3	8.3	8.3
i	10	10	10
Conductor mm ² min	25	25	25
Conductor mm ² max	70	70	70

Surface Mounting Socket Outlet

Temperature resistant contact-carrier
M50 top cable entry

 Watertight

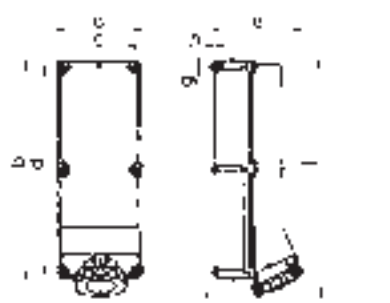

	Amperes		
	3	4	5
Poles	3	4	5
a	180	180	180
b	460	460	460
c	160	160	160
d	440	440	440
e	208	208	208
f	510	510	510
ø g	8.3	8.3	8.3
h	6.5	6.5	6.5
i	M40	M40	M40
k	M40/50	M40/50	M40/50
Conductor mm ² min	25	25	25
Conductor mm ² max	70	70	70

Surface Mounting Socket Outlet

Temperature resistant contact-carrier
M40 top and 1x M40/M50 bottom cable entries

 Watertight

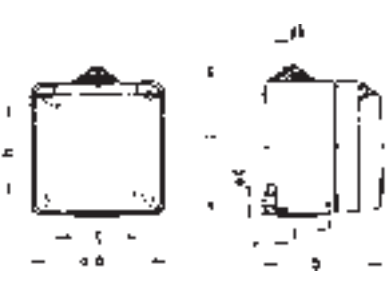

	16		32
	3	5	5
Poles	3	5	5
a	91	91	90
b	79.5	79.5	93
c	100	100	112.5
ø d	5.5	5.5	5.5
e	73	73	-
f	7	7	6
g	-	-	58
ø h	-	-	73
i	-	-	1.5
ø k	20max	20max	8/20

Surface Mounting Socket Outlet

Straight plug-in direction cable entry one at top (open) and one at bottom (closed)

 Splashproof

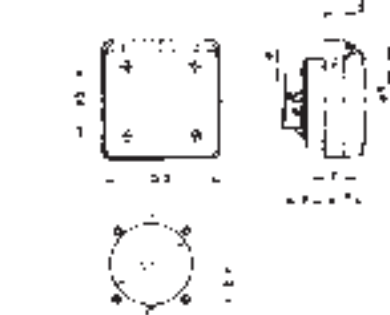



	16		32
	3	5	5
Poles	3	5	5
a	91	91	90
b	53	53	60
c	15.2	15.2	-
d	2.7	2.7	-
e	33	33	31
f	31	31	39.5
ø h	7.5	7.5	-
ø i	4.8	4.8	4.1
k	-	34	42.5
l	54	64	75
r	-	10	10

Surface Mounting Socket Outlet



Straight plug-in direction suitable for cable ducts and energy columns
16 Amp version with intermediate flange for cable duct socket with 4-point drill holes fastening

 Splashproof

A	V	Hz		EARTH HR. POS		EARTH HR. POS		EARTH HR. POS
CURRENT	VOLTAGE	FREQUENCY	2P+E		3P+E		3P+N+E	

Socket Outlets

CEE NORM

16 	110	50 - 60	1216	4	1219	4	1225	4
	240	50 - 60	1217	6	1220	9	1226	9
	415	50 - 60	1218	9	1221	6	1227	6
32 	110	50 - 60	1228	4	1231	4	1237	4
	240	50 - 60	1229	6	1232	9	1238	9
	415	50 - 60	1230	9	1233	6	1239	6



Panel Mounting Socket Outlet

 Splashproof

20° Angle

63 	110	50 - 60	12134	4	12137	4	12138	4
	240	50 - 60	12135	6	1207	9	1208	9
	415	50 - 60	12136	9	1201	6	1202	6



Panel Mounting Socket Outlet

 Splashproof

15° Angle

16 	110	50 - 60	130	4	13015	4		
	240	50 - 60	131	6	13016	9		
	415	50 - 60	132	9	13017	6		



Panel Mounting Socket Outlet

 Splashproof

Straight

16 	110	50 - 60	1310	4	1313	4	1319	4
	240	50 - 60	1311	6	1314	9	1320	9
	415	50 - 60	1312	9	1315	6	1321	6



Note: 1310 & 1311 are the popular versions



Panel Mounting Socket Outlet

 Splashproof

Straight

16 	110	50 - 60	13000	4	1322	4	13003	4
	240	50 - 60	13001	6	1323	9	13004	9
	415	50 - 60	13002	9	1324	6	13005	6
32 	110	50 - 60	13006	4	13009	4	1331	4
	240	50 - 60	13007	6	13010	9	1332	9
	415	50 - 60	13008	9	13011	6	1333	6



Panel Mounting Socket Outlet

 Splashproof

Straight Flange 75 x 75 mm

63 	110	50 - 60	1306	4	1309	4	13140	4
	240	50 - 60	1307	6	1304	9	1305	9
	415	50 - 60	1308	9	134	6	136	6



Panel Mounting Socket Outlet

 Splashproof

Straight

16A and 32A with screw terminals

63A with screw / clamp terminals and pilot contact

Note: This pilot contact should **NOT** be counted as a main 'pin'

Other voltages and frequencies are available on request. Contact CEE Norm UK for further details

Dimensions





Amperes	16			32		
	3	4	5	3	4	5
Poles						
a	74	100	100	100	100	100
b	62	92	92	92	92	92
c	60	85	85	85	85	85
d	52	77	77	77	77	77
e	5.5	5.5	5.5	5.5	5.5	5.5
f	8	8	8	8	8	8
h	30	30	29	50	50	50
i	48	50	55	62	62	62
k	57	65	70	75	75	78
l	52	65	70	75	75	78
a	20°	20°	20°	20°	20°	20°
Conductor mm ² min	1.5	1.5	1.5	2.5	2.5	2.5
Conductor mm ² max	4	4	4	10	10	10

Panel Mounting Socket Outlet
 20° Angle
 Splashproof



Amperes	63		
	3	4	5
Poles			
a	114	114	114
b	114	114	114
c	90	90	90
d	90	90	90
e	6.5	6.5	6.5
f	12	12	12
h	65	65	65
i	67.5	67.5	67.5
l	92	92	92
Conductor mm ² min	6	6	6
Conductor mm ² max	25	25	25

Panel Mounting Socket Outlet
 15° Angle temperature resistant contact-carrier
 Splashproof





Amperes	16	
	3	4
Poles		
a	56	60
b	56	60
c	44	50-52
d	44	50-52
e	4.4	5.5
f	7	7
h	17	26
i	51	53
k	70	80
l	45	45
m	13	9
Conductor mm ² min	1.5	1.5
Conductor mm ² max	4	4

Panel Mounting Socket Outlet
 Splashproof





Amperes	16		
	3	4	5
Poles			
a	62	72	72
b	62	65	65
c	47	52	52
d	47	52	52
e	5.5	5.5	5.5
f	7	7	7
h	17	26	17
i	51	53	53
k	70	80	85
l	45	45	55
m	10	9	13
Conductor mm ² min	1.5	1.5	1.5
Conductor mm ² max	4	4	4

Panel Mounting Socket Outlet
 Splashproof







Amperes	16			32		
	3	4	5	3	4	5
Poles						
a	75	75	75	75	75	75
b	75	75	75	75	75	75
c	60	60	60	60	60	60
d	60	60	60	60	60	60
e	5.5	5.5	5.5	5.5	5.5	5.5
f	7	7	7	8	8	8
h	17	26	17	36	36	19
i	51	53	53	62	62	62
k	70	80	85	90	90	98
l	45	45	55	60	60	60
m	3.5	7	11.5	12	12	17
Conductor mm ² min	1.5	1.5	1.5	2.5	2.5	2.5
Conductor mm ² max	4	4	4	10	10	10

Panel Mounting Socket Outlet
 Splashproof





Amperes	63		
	3	4	5
Poles			
a	107	107	107
b	100	100	100
c	85	85	85
d	77	77	77
e	6.5	6.5	6.5
f	12	12	12
h	56	56	56
i	77	77	77
k	110	110	110
l	88	88	88
m	7	7	7
Conductor mm ² min	6	6	6
Conductor mm ² max	25	25	25

Panel Mounting Socket Outlet
 Temperature resistant contact-carrier
 Splashproof

A	V	Hz		EARTH HR. POS		EARTH HR. POS		EARTH HR. POS
CURRENT	VOLTAGE	FREQUENCY	2P+E		3P+E		3P+N+E	

Socket Outlets

CEE NORM



16 	110	50 - 60	1265	4	1268	4	1274	4
	240	50 - 60	1266	6	1269	9	1275	9
	415	50 - 60	1267	9	1270	6	1276	6
32 	110	50 - 60	1277	4	1280	4	1286	4
	240	50 - 60	1278	6	1281	9	1287	9
	415	50 - 60	1279	9	1282	6	1288	6



Panel Mounting Socket Outlet

 Watertight

20° Angle

63 	110	50 - 60	12000	4	12003	4	12004	4
	240	50 - 60	12001	6	1205	9	1206	9
	415	50 - 60	12002	9	1200	6	129	6
125 	110	50 - 60	1299	4	12102	4	12106	4
	240	50 - 60	12100	6	12103	9	12107	9
	415	50 - 60	12101	9	12104	6	12108	6



Panel Mounting Socket Outlet

 Watertight

15° Angle



16 	110	50 - 60	1356	4	1359	4	1365	4
	240	50 - 60	1357	6	1360	9	1366	9
	415	50 - 60	1358	9	1361	6	1367	6



Panel Mounting Socket Outlet

 Watertight

Straight



16 	110	50 - 60	1371	4	1374	4	1380	4
	240	50 - 60	1372	6	1375	9	1381	9
	415	50 - 60	1373	9	1376	6	1382	6
32 	110	50 - 60	13023	4	13026	4	1368	4
	240	50 - 60	13024	6	13027	9	1369	9
	415	50 - 60	13025	9	13028	6	1370	6



Panel Mounting Socket Outlet

 Watertight

Straight

63 	110	50 - 60	1395	4	1398	4	13102	4
	240	50 - 60	1396	6	1399	9	13103	9
	415	50 - 60	1397	9	13100	6	13104	6
125 	110	50 - 60	13445	4		4		4
	240	50 - 60	13452	6		9		9
	415	50 - 60		9	13447	6	13451	6



Panel Mounting Socket Outlet

 Watertight

Straight

16A and 32A with screw terminals

63A and 125A with screw / clamp terminals and pilot contact

Note: This pilot contact should **NOT** be counted as a main 'pin'

Other voltages and frequencies are available on request. Contact CEE Norm UK for further details

Dimensions

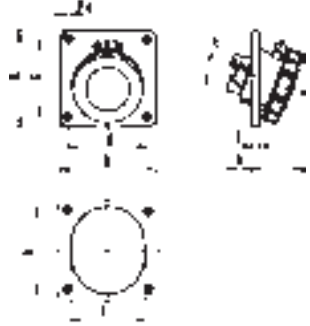

Amperes	16			32		
Poles	3	4	5	3	4	5
a	74	100	100	100	100	100
b	62	92	92	92	92	92
c	60	85	85	85	85	85
d	52	77	77	77	77	77
e	5.5	5.5	5.5	5.5	5.5	5.5
f	8	8	8	8	8	8
h	30	28.5	29	50	50	34
i	55	57.5	60	67	67	69
k	57	65	70	75	75	78
l	52	65	70	75	75	78
a	20°	20°	20°	20°	20°	20°
Conductor mm ² min	1.5	1.5	1.5	2.5	2.5	2.5
Conductor mm ² max	4	4	4	10	10	10

Panel Mounting Socket Outlet

20° Angle

 Watertight



Amperes	63			125		
Poles	3	4	5	3	4	5
a	114	114	114	114	114	114
b	114	144	114	114	114	114
c	90	90	90	90	90	90
d	90	90	90	90	90	90
e	6.5	6.5	6.5	6.5	6.5	6.5
f	12	12	12	12	12	12
h	65	65	64	82	82	82
j	80	80	80	90	90	90
k	92	92	92	92	92	92
l	92	92	92	104	104	104
Conductor mm ² min	6	6	6	25	25	25
Conductor mm ² max	25	25	25	70	70	70

Panel Mounting Socket Outlet

15° Angle temperature resistant contact-carrier

 Watertight

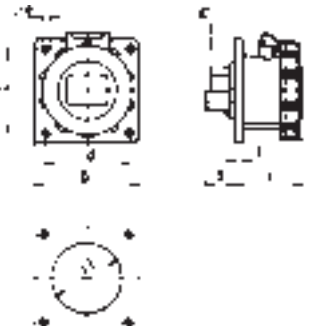

Amperes	16		
Poles	3	4	5
a	62	72	72
b	62	65	65
c	47	52	52
d	47	52	52
e	5.5	5.5	5.5
f	7	7	7
h	17	26	17
i	57	58	57
k	76	83	93
l	45	45	55
m	10	9	13
Conductor mm ² min	1.5	1.5	1.5
Conductor mm ² max	4	4	4

Panel Mounting Socket Outlet

 Watertight

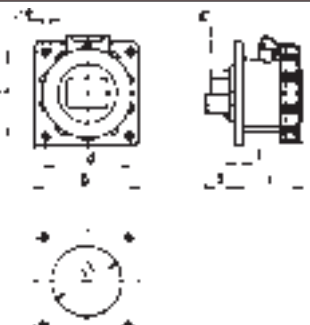

Amperes	16			32		
Poles	3	4	5	3	4	5
a	75	75	75	75	75	75
b	75	75	75	75	75	75
c	60	60	60	60	60	60
d	60	60	60	60	60	60
e	5.5	5.5	5.5	5.5	5.5	5.5
f	7	7	7	8	8	8
h	17	26	17	36	36	19
i	57	58	57	65	65	65
k	76	83	93	100	100	106
l	45	45	55	60	60	60
m	3.5	7	11.5	12	12	17
Conductor mm ² min	1.5	1.5	1.5	2.5	2.5	2.5
Conductor mm ² max	4	4	4	10	10	10

Panel Mounting Socket Outlet

 Watertight

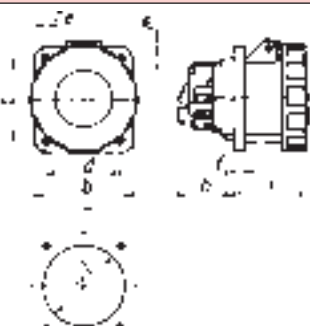

Amperes	63			125		
Poles	3	4	5	3	4	5
a	107	107	107	120	120	120
b	100	100	100	120	120	120
c	85	85	85	100	100	100
d	77	77	77	100	100	100
e	6.5	6.5	6.5	6.5	6.5	6.5
f	12	12	12	21	21	21
h	56.5	56.5	56.5	50	50	50
i	76	76	76	117	117	117
k	113	113	113	129	129	129
l	88	88	88	84	84	84
m	7	7	7	6	6	6
Conductor mm ² min	6	6	6	25	25	25
Conductor mm ² max	25	25	25	70	70	70

Panel Mounting Socket Outlet

Temperature resistant contact-carrier

 Watertight

Notes:

Switched Interlocked Sockets



Chemical and Heavy Industry



Harbour installation containers, ship yards and shipping lines

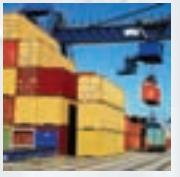

Mining and tunnelling

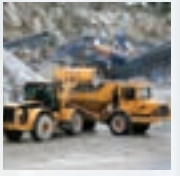

Camping and caravanning



Building and construction industry

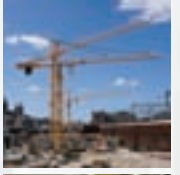

Food processing and packaging

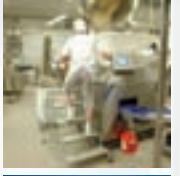

Agriculture and farming

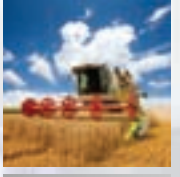

Military applications

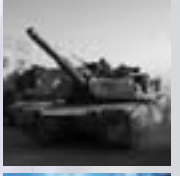

Industrial and commercial properties



Power generation and distribution



Oil and gas (non hazardous areas)

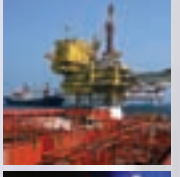

Film, TV and outdoor events

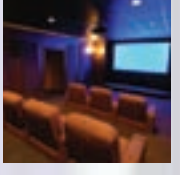

Switched Interlocked Sockets



- Wear-resistant and impact-resistant plastic
- Can be equipped with RCD/MCB or RCBO
- Flip-open window of smoked glass



- Dirt-repellent opening direction
- Extensive exclusion of malfunctions



- Can be locked in 0 'off' position (3-fold) in the case of all switched interlocked sockets



- Interlocking mechanism in base for 16A in housing 170 x 90 mm
- Compact
- Space-saving
- IP44 and IP67

Safe, Robust, Easy to Install



- Cable entry with metric thread
- Watertight and splashproof design



- Corrosion-resistant synthetic housing screws





- Interlocking mechanism in base
- Compact and space-saving
- Switching in load-free state through mechanical interlocking, prevents plugging and unplugging under load
- Cable entry possible from above and below
- Robust, compact switch, mounted on top-hat profile rail
- 63A and 125A with KONTEX-PLUS and screw / clamp terminals
- No maintenance of the locking parts required
- IP44 and IP67

63A and 125A products are fitted with pilot contact

Note:
This pilot contact should **NOT** be counted as a main 'pin'



- Good sealing through foamed seal
- Free of silicon, CFCs and halogen

A	V	Hz		EARTH HR. POS		EARTH HR. POS		EARTH HR. POS
CURRENT	VOLTAGE	FREQUENCY	2P+E		3P+E		3P+N+E	

Switched Interlocked Sockets

CEE NORM

16 	110	50 - 60	16165	4	16171	4	16181	4
	240	50 - 60	16167	6	16173	9	16183	9
	415	50 - 60	16169	9	16175	6	16185	6



Socket Outlet

Switched with mechanical double-interlocking
 Splashproof

32 	110	50 - 60	16191	4	16197	4	16207	4
	240	50 - 60	16193	6	16199	9	1644	9
	415	50 - 60	16154	9	16201	6	16211	6



Socket Outlet

Switched with mechanical double-interlocking
 Splashproof

63 	110	50 - 60	16217	4	16223	4	16233	4
	240	50 - 60	16219	6	16225	9	16235	9
	415	50 - 60	16221	9	16227	6	16237	6



Socket Outlet

Switched with mechanical double-interlocking
 Splashproof

16 	110	50 - 60	16166	4	16172	4	16182	4
	240	50 - 60	16168	6	16174	9	16184	9
	415	50 - 60	16170	9	16176	6	16186	6



Socket Outlet

Switched with mechanical double-interlocking
 Watertight

32 	110	50 - 60	16192	4	16198	4	16208	4
	240	50 - 60	16194	6	16200	9	16210	9
	415	50 - 60	16196	9	16202	6	16212	6



Socket Outlet

Switched with mechanical double-interlocking
 Watertight

63 	110	50 - 60	16218	4	16224	4	16234	4
	240	50 - 60	16220	6	16226	9	16236	9
	415	50 - 60	16222	9	16228	6	16238	6



Socket Outlet

Switched with mechanical double-interlocking
 Watertight

125 	110	50 - 60		4	1693	4		4
	240	50 - 60	16293	6	1634	9	1637	9
	415	50 - 60		9	1635	6	169	6



Socket Outlet

Switched with mechanical double-interlocking
 Watertight

Dimensions

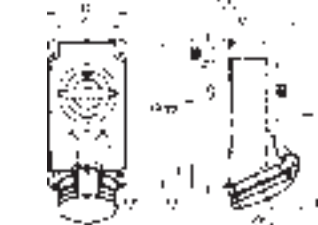

Amperes	16		
Poles	3	4	5
a	90	90	90
b	170	170	170
c	77	77	77
d	137.5	137.5	137.5
e	108	114	121
f	188.5	188.5	190
g	6	6	6
Ø h	5.5	5.5	5.5

Socket Outlet

Switched with mechanical double-interlocking

 Splashproof

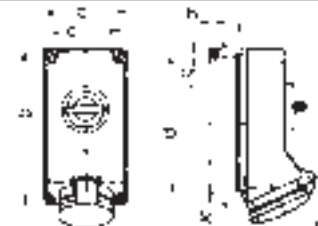

Amperes	32		
Poles	3	4	5
a	118	118	118
b	225	225	225
c	101	101	101
d	208	208	208
e	137	137	144
f	251	251	251
Ø g	6.5	6.5	6.5
h	8	8	8
i	1x M25	1x M25	1x M25
k	2x M25	2x M25	2x M25

Socket Outlet

Switched with mechanical double-interlocking

 Splashproof



Amperes	63		
Poles	3	4	5
a	160	160	160
b	260	260	260
c	140	140	140
d	240	240	240
e	184	184	184
f	302	302	302
Ø g	8.1	8.1	8.1
h	10	10	10
i	1x M32	1x M32	1x M32
k	2x M32	2x M32	2x M32

Socket Outlet

Switched with mechanical double-interlocking

 Splashproof



Amperes	16		
Poles	3	4	5
a	90	90	90
b	170	170	170
c	77	77	77
d	137.5	137.5	137.5
e	108	114	121
f	191.5	191.5	191.5
g	6	6	6
Ø h	5.5	5.5	5.5

Socket Outlet

Switched with mechanical double-interlocking

 Watertight



Amperes	32		
Poles	3	4	5
a	118	118	118
b	225	225	225
c	101	101	101
d	208	208	208
e	143	143	149
f	255	255	255
Ø g	6.5	6.5	6.5
h	8	8	8
i	1x M25	1x M25	1x M25
k	2x M25	2x M25	2x M25

Socket Outlet

Switched with mechanical double-interlocking

 Watertight



Amperes	63		
Poles	3	4	5
a	160	160	160
b	260	260	260
c	140	140	140
d	240	240	240
e	195	195	195
f	304	304	304
Ø g	8.1	8.1	8.1
h	10	10	10
i	1x M32	1x M32	1x M32
k	2x M32	2x M32	2x M32

Socket Outlet

Switched with mechanical double-interlocking

 Watertight

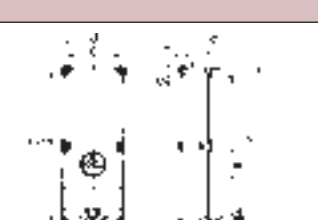

Amperes	125		
Poles	3	4	5
a	180	180	180
b	460	460	460
c	160	160	160
d	440	440	440
e	208	208	208
f	510	510	510
Ø g	8.3	8.3	8.3
h	6.5	6.5	6.5
i	M40	M40	M40
k	M50/M40	M50/M40	M50/M40

Socket Outlet

Switched with mechanical double-interlocking

 Watertight

Plugs and Appliance Inlets

16A and 32A IP44 plugs on page 40 are fitted with screw terminals, one piece bodies with Multi-Grip cable gland (except angled plugs).

16A and 32A IP67 plugs on page 42 are fitted with QUICK-CONNECT terminals, screw together bodies and Multi-Grip cable glands.

63A and 125A IP67 plugs on page 42 are fitted with screw / clamp terminals, screw together bodies and Multi-Grip cable glands.

The 16A, 32A, 63A and 125A appliance inlets on pages 44 - 52 are fitted with screw terminals (63A and 125A with screw / clamp terminals).

For QUICK-CONNECT plugs IP44
16A - 63A see page 70.

Plugs and Appliance Inlets



Plugs

page 40

Surface Mounting Appliance Inlets

page 44

Panel Mounting Appliance Inlets

page 48

Chemical and Heavy Industry



Harbour installation containers, ship yards and shipping lines

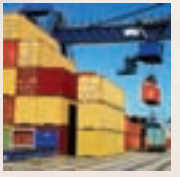

Mining and tunnelling

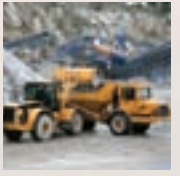

Camping and caravanning

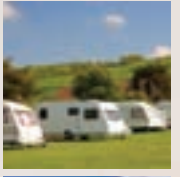

Building and construction industry

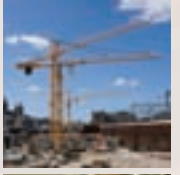

Food processing and packaging

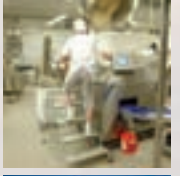

Agriculture and farming

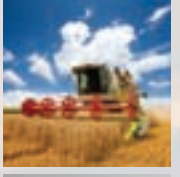

Military applications

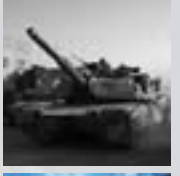

Industrial and commercial properties



Power generation and distribution



Oil and gas (non hazardous areas)

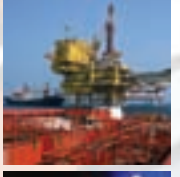

Film, TV and outdoor events

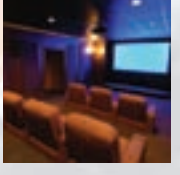

Plugs and Appliance Inlets



- QUICK-CONNECT 16A and 32A IP44 plug housings
- Lock engages automatically, and securely on closing
- Lock can be opened by turning clockwise with a screwdriver
- QUICK-CONNECT 16A and 32A IP67 plugs have two sealing screws to secure the contact carrier to the housing
- 63A and 125A plugs have screw-together housings

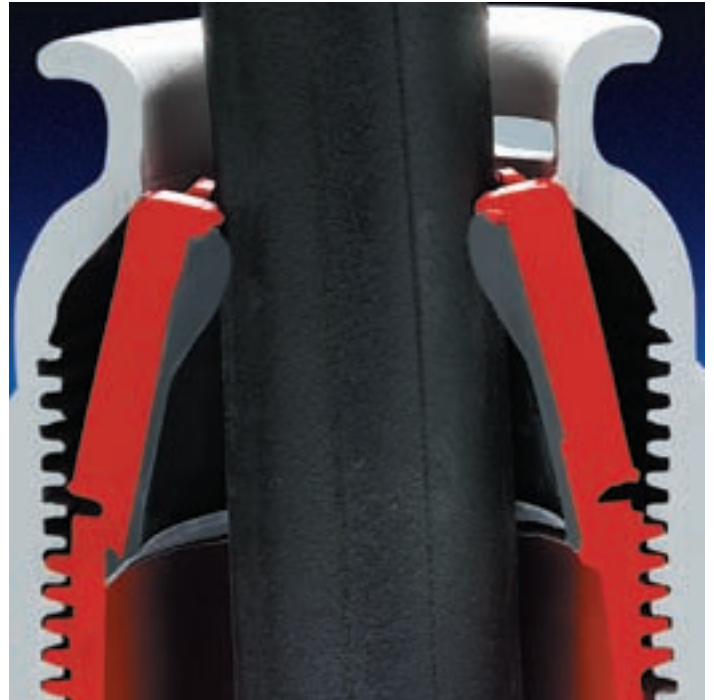

- Multi-Grip cable gland
- Rubber seal, firmly moulded on, facilitates connection
- No additional seals and rings required
- 18 flexible laminae adapt to the cable diameter
- The Multi-Grip screw connection achieves a high tensile strength whilst simultaneously protecting the cable



- Screwless QUICK-CONNECT cage clamp terminals
- Simple housing connection through pressure screw-thread connection
- Opening and closing by simply turning around 90°
- The tensile strength of the 4-point (quarter turn) locking system is over 2400N for 16A, and over 4700 N for 32A

Safe, Robust, Easy to Install

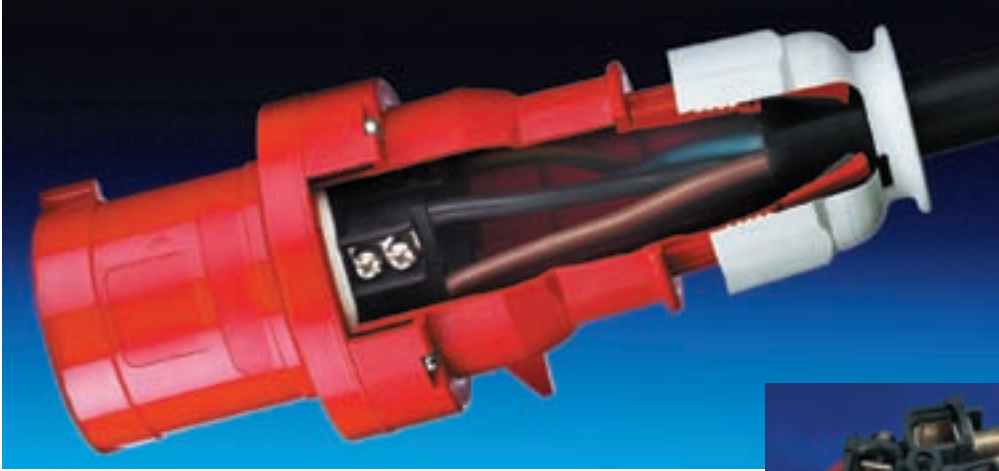

- Generous connection space
- No awkward strain relief, due to Multi-Grip cable gland
- Cage clamp terminals with 16A and 32A (or screw terminals are available)
- Screw / clamp terminals for 63A and 125A
- 16A and 32A short and long cable sleeve plugs on page 40 (non QUICK-CONNECT) are fitted with internal cable grip





- Fibre glass-reinforced and particularly temperature-resistant contact carriers
- Cable up to 36mm diameter for 63A, up to 50mm diameter for 125A
- Brass-nickel-plated screw / clamp terminals for 63A and 125A
- Can accommodate large conductor cross-sections
- Cable ferrules are not necessary
- Even contact pressure
- Minimised transition resistance



- QUICK-CONNECT cage clamp technology for 16A and 32A (or screw terminals are available)
- Brass-nickel-plated screw / clamp terminals for 63A and 125A
- Accommodation of large cable cross-sections
- Even contact pressure with minimised transition resistance



- Screwless QUICK-CONNECT terminals
- Cable ferrules are not required
- Terminal is closed by simply pressing a finger on the contact slide
- Reliable and lasting connection through tension spring technology (cage clamp)
- The damage-free conductor clamping guarantees optimum connection over the whole service life

16 	110	50 - 60	21000-TLS	4	21003-TLS	4	21009-TLS	4
	240	50 - 60	21001-TLS	6	21004-TLS	9	21010-TLS	9
	415	50 - 60	21002-TLS	9	21005-TLS	6	203-TLS	6
32 	110	50 - 60	21012-TLS	4	21015-TLS	4	21021-TLS	4
	240	50 - 60	21013-TLS	6	21016-TLS	9	21022-TLS	9
	415	50 - 60	21014-TLS	9	21017-TLS	6	204-TLS	6



Plug with Multi-Grip Cable Gland

- One piece body

 Splashproof

16 	110	50 - 60	230	4	233	4		4
	240	50 - 60	231	6	234	9		9
	415	50 - 60	232	9	235	6	236	6



Angled Plug with Short Cable Sleeve

 Splashproof

16A and 32A with screw terminals

63 	110	50 - 60	21024	4	2149	4	2153	4
	240	50 - 60	2104	6	2150	9	2154	9
	415	50 - 60	21025	9	2151	6	2155	6



Plug with Multi-Grip Cable Gland

- Screw / clamp terminals

 Splashproof

63A with screw / clamp terminals and pilot contact

Note: This pilot contact should **NOT** be counted as a main 'pin'

All items on this page have screw terminals.
125A is only available in IP67 see page 42.

Dimensions



	16			32		
	3	4	5	3	4	5
Amperes						
Poles						
Ø a	54	60	66	71	71	80
b	94.5	98	101	115	115	119
c	138	142	145	170	170	174
d	101.5	105.5	108.5	124	124	128
Ø e	18	18	18	23	23	23
f	56.6	64	71	76	76	85
Conductor mm ² min	1	1	1	2.5	2.5	2.5
Conductor mm ² max	2.5	2.5	2.5	6	6	6

Plug with Multi-Grip Cable Gland

- One piece body
-  Splashproof



	16		
	3	4	5
Amperes			
Poles			
a	80	85	96
b	44	49	59
Ø c	6.5	6.5	8
Ø d	18	18	18
e	51	57	64
f	90	85	74
Conductor mm ² min	1.5	1.5	1.5
Conductor mm ² max	4	4	4

Angled Plug with Short Cable Sleeve



-  Splashproof



	63		
	3	4	5
Amperes			
Poles			
Ø a	96	96	96
b	164	164	164
c	245	245	245
d	178	178	178
Ø e	36	36	36
Conductor mm ² min	6	6	6
Conductor mm ² max	16	16	16

Plug with Multi-Grip Cable Gland

- Multi-Grip cable gland system with moulded-in gasket
- Max cable diameter 36mm
- Screw / clamp terminals
-  Splashproof

16 	110	50 - 60	21237	4	21403	4	21406	4
	240	50 - 60	21238	6	21250	9	21407	9
	415	50 - 60	21402	9	21349	6	21239	6
32 	110	50 - 60	21408	4	21410	4	21413	4
	240	50 - 60	21240	6	21251	9	21414	9
	415	50 - 60	21409	9	21351	6	21241	6



Plug QUICK-CONNECT with Multi-Grip Cable Gland

 Watertight

QUICK CONNECT[®]

The range of QUICK-CONNECT products are shown on pages 61 -73

63 	110	50 - 60	2180	4	2183	4	2187	4
	240	50 - 60	2181	6	2184	9	2188	9
	415	50 - 60	2182	9	2185	6	2189	6



Plug with Multi-Grip Cable Gland

 Watertight

125 	110	50 - 60	2190	4	2193	4	2197	4
	240	50 - 60	2191	6	2194	9	2198	9
	415	50 - 60	2192	9	2195	6	2199	6



Plug with Multi-Grip Cable Gland

 Watertight

63A and 125A with screw / clamp terminals and pilot contact

Note: This pilot contact should **NOT** be counted as a main 'pin'

All items on this page are IP67 watertight

Dimensions

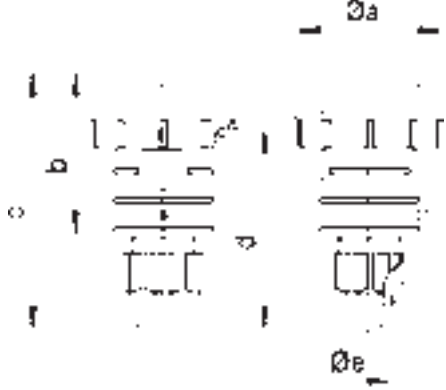

Amperes	16			32		
	3	4	5	3	4	5
Poles						
Ø a	70	78	86	94	94	101
b	95	95	97	118	118	117
c	145	145	152	178	178	181
d	111	111	119	136	136	138.5
Ø e	18	18	21	23	23	27
Conductor mm ² min	1	1	1	2.5	2.5	2.5
Conductor mm ² max	2.5	2.5	2.5	6	6	6

Plug QUICK-CONNECT with Multi-Grip Cable Gland

- Screwless terminals
- Multi-Grip cable gland system with moulded-in gasket
- Nickel-plated contacts
- High temperature resistant contact carrier

 Watertight



Amperes	63		
	3	4	5
Poles			
Ø a	113.5	113.5	113.5
b	164	164	164
c	245	245	245
d	177	177	177
Ø e	36	36	36
Conductor mm ² min	6	6	6
Conductor mm ² max	16	16	16

Plug with Multi-Grip Cable Gland

- Multi-Grip cable gland system with moulded-in gasket
- High temperature resistant contact carrier
- Screw / clamp terminals
- Nickel-plated contacts

 Watertight





Amperes	125		
	3	4	5
Poles			
Ø a	126	126	126
b	181	181	181
c	282	282	282
d	206	206	206
Ø e	50	50	50
Conductor mm ² min	16	16	16
Conductor mm ² max	50	50	50

Plug with Multi-Grip Cable Gland

- Multi-Grip cable gland system with moulded-in gasket
- High temperature resistant contact carrier
- Screw / clamp terminals
- Nickel-plated contacts

 Watertight

A CURRENT	V VOLTAGE	Hz FREQUENCY	 2P+E	EARTH HR. POS 4	 3P+E	EARTH HR. POS 4	 3P+N+E	EARTH HR. POS 4
--------------	--------------	-----------------	--	--------------------------	--	--------------------------	--	--------------------------

Appliance Inlets

CEE NORM

16 	110	50 - 60	244	4	247	4	2413	4
	240	50 - 60	245	6	248	9	2414	9
	415	50 - 60	246	9	249	6	2415	6



Surface Mounting Appliance Inlet

 Splashproof

32 	110	50 - 60	24167	4	24170	4	24176	4
	240	50 - 60	24168	6	24171	9	24177	9
	415	50 - 60	24169	9	24172	6	24144	6

16A and 32A with screw terminals



Surface Mounting Appliance Inlet

 Splashproof

63 	110	50 - 60						
	240	50 - 60	24336	6				
	415	50 - 60			24205	6	24134	6

63A with screw / clamp terminals and pilot contact

Note: This pilot contact should **NOT** be counted as a main 'pin'



Surface Mounting Appliance Inlet

 Splashproof

16 	240	50 - 60	240	6				
---	-----	---------	------------	---	--	--	--	--



16 	240	50 - 60	242	6	As above with hinged lid			
---	-----	---------	------------	---	--------------------------	--	--	--



Surface Mounting Appliance Inlet

 Splashproof

As above with hinged lid

16 	110	50 - 60	2460	4	2463	4	2469	4
	240	50 - 60	2461	6	2464	9	2470	9
	415	50 - 60	2462	9	2465	6	2471	6
32 	110	50 - 60	24335	4		4		4
	240	50 - 60	24017	6		9		9
	415	50 - 60		9	24018	6	24012	6

16A and 32A with screw terminals



Surface Mounting Appliance Inlet

 Splashproof

With hinged lid

Other voltages and frequencies are available on request. Contact CEE Norm UK for further details

Dimensions

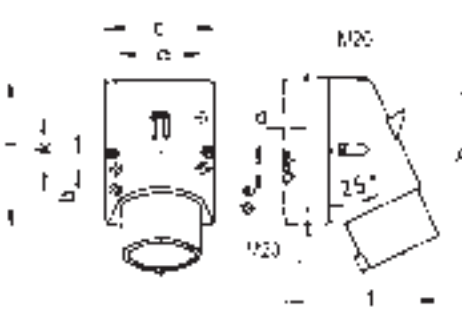

Amperes	16		
Poles	3	4	5
a	51	59	59
b	-	11	11
c	64	75	75
d	4	4	4
Ø e	4.1	5.1	5.1
f	93	106	110
h	122	135	135
i	87	100	100
k	40	-	-
Conductor mm ² min	1	1	1
Conductor mm ² max	2.5	2.5	2.5

Surface Mounting Appliance Inlet

 Splashproof



Amperes	32		
Poles	3	4	5
a	83	83	83
b	126	126	126
c	165	165	166
d	128	128	130
e	68	68	68
f	11	11	11
Ø h	5.5	5.5	5.5
i	6.5	6.5	6.5
Ø k	12	12	12
l	65	65	65
m	80	80	80
Ø n	10	10	10
p	M25	M25	M25
r	2xM25	2xM25	2xM25
Conductor mm ² min	2.5	2.5	2.5
Conductor mm ² max	6	6	6

Surface Mounting Appliance Inlet

 Splashproof

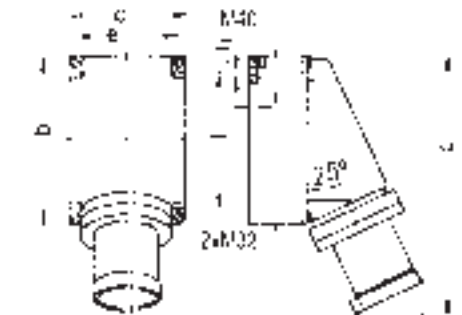



Amperes	63		
Poles	3	4	5
a	118	118	118
b	170	170	170
c	259	259	259
d	174	174	174
e	104	104	104
f	136	136	136
Ø h	6.1	6.1	6.1
i	6	6	6
Conductor mm ² min	6	6	6
Conductor mm ² max	16	16	16

Surface Mounting Appliance Inlet

 Splashproof



Amperes	16		With hinged lid		Amperes	16	
	3	4	3	4		3	4
Poles	3	4	3	4	Poles	3	4
a	56.5	60	56.5	60	a	56.5	60
b	60	60	60	60	b	60	60
c	93	93	93	93	c	93	93
d	73	73	73	73	c1	97.5	97.5
e	29.5	29.5	29.5	29.5	d	73	73
f	23.5	23.5	23.5	23.5	d1	84	84
Ø h	5.5	5.5	5.5	5.5	e	29.5	29.5
i	3	3	3	3	f	23	23
Conductor mm ² min	1	1	1	1	Ø h	5.5	5.5
Conductor mm ² max	2.5	2.5	2.5	2.5	i	3	3
					i1	16	16
					Conductor mm ² min	1	1
					Conductor mm ² max	2.5	2.5

Amperes	16		With hinged lid		Amperes	16		32	
	3	4	3	4		5	3	4	5
Poles	3	4	3	4	Poles	5	3	4	5
a	64	75	64	75	a	84	90	90	90
b	87	100	87	100	b	84	75	75	75
c	138	150	138	150	c	129	138	138	139
d	111	120	111	120	c1	138	149	149	150
e	51	59	51	59	d	101	110	110	111
f	-	11	-	11	d1	105	114	114	115
Ø h	4.1	5.1	4.1	5.1	e	5.5	5.5	5.5	5.5
i	4.5	4.5	4.5	4.5	f	64	45	45	45
k	40	-	40	-	h	64	78	78	78
l	M20	M20	M20	M20	i	-	13	13	13
m	for M20	for M20	for M20	for M20	Ø k	23	29	29	29
Conductor mm ² min	1	1	1	1	l	M20	M25	M25	M25
Conductor mm ² max	2.5	2.5	2.5	2.5					

A CURRENT	V VOLTAGE	Hz FREQUENCY	 2P+E	EARTH HR. POS	 3P+E	EARTH HR. POS	 3P+N+E	EARTH HR. POS
--------------	--------------	-----------------	---	---------------------	---	---------------------	---	---------------------

Appliance Inlets



16 	110	50 - 60	2472	4	2475	4	2481	4
	240	50 - 60	2473	6	2476	9	2482	9
	415	50 - 60	2474	9	2477	6	2483	6
32 	110	50 - 60	24154	4				
	240	50 - 60	24020	6				
	415	50 - 60		9	24021	6	2402	6



Surface Mounting Appliance Inlet

 Watertight

16 	110	50 - 60	2484	4	2487	4	2493	4
	240	50 - 60	2485	6	2488	9	2494	9
	415	50 - 60	2486	9	2489	6	2495	6
32 	110	50 - 60	24216	4				
	240	50 - 60	24023	6				
	415	50 - 60		9	24024	6	24013	6



* As above with Fastening Cap

 Watertight

16A and 32A with screw terminals

63 	110	50 - 60						
	240	50 - 60	24184	6	24185	9		
	415	50 - 60		9	24035	6	24062	6



Surface Mounting Appliance Inlet

 Watertight

125 	110	50 - 60	24197	4				
	240	50 - 60	24198	6	24199	9		
	415	50 - 60			24200	6	24202	6



Surface Mounting Appliance Inlet

Top M50 Cable Entry

 Watertight

125 	110	50 - 60		4				
	240	50 - 60	24007	6				
	415	50 - 60			24008	6	24010	6



Surface Mounting Appliance Inlet

Top M40 Cable Entry

Bottom 1x M40/M50

 Watertight

63A and 125A with screw / clamp terminals and pilot contact

Note: This pilot contact should **NOT** be counted as a main 'pin'



Other voltages and frequencies are available on request. Contact CEE Norm UK for further details

Dimensions



Amperes	16		
Poles	3	4	5
a	64	75	84
b	87	100,0	84
c	137	151	136
d	112	119	-
e	51	59	-
f	-	11	-
Ø h	4.1	5.1	-
i	4.5	4.5	-
k	40	-	-
l	-	-	111
m	-	-	64
n	-	-	64
Ø o	-	-	5.5
p	M20	M20	-
r	-	-	M20
s	-	-	23
t	M20	M20	-

Surface Mounting Appliance Inlet

 Watertight

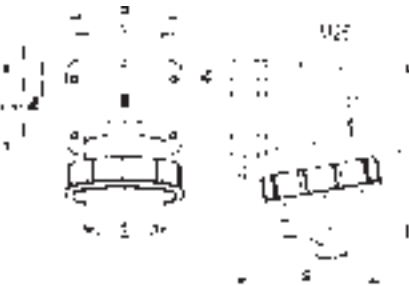

Amperes	32		
Poles	3	4	5
a	90	90	90
b	75	75	75
c	78	78	78
d	45	45	45
Ø e	5.5	5.5	5.5
f	28	28	28
g	122	122	123
h	138	138	139
i	13	13	13
Ø k	29	29	29

As above with Fastening Cap

 Watertight

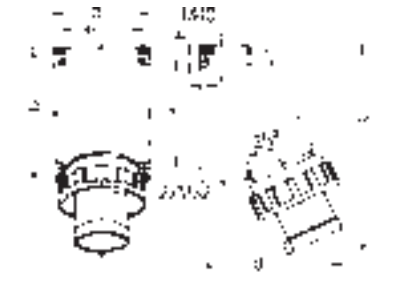

Amperes	63		
Poles	3	4	5
a	118	118	118
b	170	170	170
c	259	259	259
d	174	174	174
e	104	104	104
f	136	136	136
Ø h	6.1	6.1	6.1
i	6	6	6
Conductor mm ² min	6	6	6
Conductor mm ² max	16	16	16

Surface Mounting Appliance Inlet

 Watertight

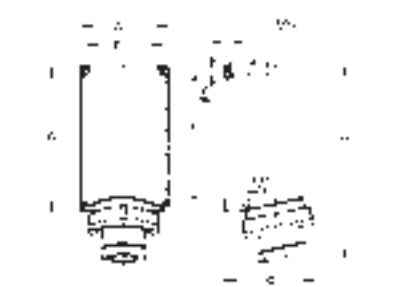

Amperes	125		
Poles	3	4	5
a	160	160	160
b	260	260	260
c	364	364	364
d	165	165	165
e	140	140	140
f	240	240	240
Ø h	8.3	8.3	8.3
i	10	10	10
Conductor mm ² min	16	16	16
Conductor mm ² max	50	50	50

Surface Mounting Appliance Inlet



 Watertight



Amperes	125		
Poles	3	4	5
a	180	180	180
b	460	460	460
c	160	160	160
d	440	440	440
e	220	220	220
f	562	562	562
Ø g	8.3	8.3	8.3
h	6.5	6.5	6.5
i	M40	M40	M40
k	M40/50	M40/50	M40/50
Conductor mm ² min	16	16	16
Conductor mm ² max	50	50	50

Surface Mounting Appliance Inlet

 Watertight

A	V	Hz		EARTH HR. POS		EARTH HR. POS		EARTH HR. POS
CURRENT	VOLTAGE	FREQUENCY	2P+E		3P+E		3P+N+E	

Appliance Inlets

CEE NORM

16 	110	50 - 60	260	4	263	4	2610	4
	240	50 - 60	261	6	264	9	2611	9
	415	50 - 60	262	9	265	6	2612	6
32 	240	50 - 60	2662	4				
	415	50 - 60			2663	6	2600	6



Panel Mounting Appliance Inlet

 Splashproof

16 	110	50 - 60	2613	4	2616	4	2622	4
	240	50 - 60	2614	6	2617	9	2623	9
	415	50 - 60	2615	9	2618	6	2624	6
32 	240	50 - 60	2665	6				
	415	50 - 60		9	2666	6	2601	6



Panel Mounting Appliance Inlet

 Watertight

16 	110	50 - 60	2625	4	2628	4	2634	4
	240	50 - 60	2626	6	2629	9	2635	9
	415	50 - 60	2627	9	2630	6	2636	6
32 	240	50 - 60	2656	6				
	415	50 - 60		9	2657	6	2655	6



Panel Mounting Appliance Inlet

With hinged lid

 Splashproof



16 	110	50 - 60	2637	4	2640	4	2646	4
	240	50 - 60	2638	6	2641	9	2647	9
	415	50 - 60	2639	9	2642	6	2636	6
32 	240	50 - 60	2659	6				
	415	50 - 60			2660	6	2604	6



Panel Mounting Appliance Inlet

With fastening cap

 Watertight

16 	110	50 - 60	2826	4	2873	4		
	240	50 - 60	2817	6				
	415	50 - 60			2831	6	2814	6
32 	110	50 - 60	2811	4				
	240	50 - 60	2827	6				
	415	50 - 60			2830	6	2815	6



Panel Mounting Appliance Inlet

 Splashproof

A retaining nose on panel for the connector is recommended

16A and 32A with screw terminals

Other voltages and frequencies are available on request. Contact CEE Norm UK for further details

Dimensions

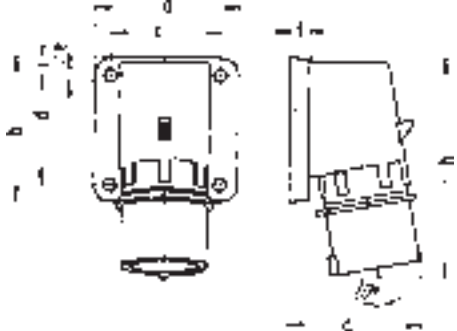

Amperes	16			32		
Poles	3	4	5	3	4	5
a	74	75	84	90	90	90
b	84	100	84	75	75	75
c	58	62	64	78	78	78
d	64	74	64	45	45	45
Ø e	5.5	4.3	5.5	5.5	5.5	5.5
f	12	12	7	7	7	7
g	70	77	78	86	86	88
h	128	145	129	138	138	140
i	-	-	-	13	13	13
Conductor mm² min	1.5	1.5	1.5	2.5	2.5	2.5
Conductor mm² max	4	4	4	10	10	10

Panel Mounting Appliance Inlet

 Splashproof

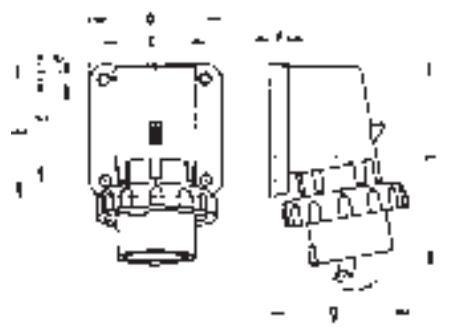

Amperes	16			32		
Poles	3	4	5	3	4	5
a	74	75	84	90	90	90
b	84	100	84	75	75	75
c	58	62	64	78	78	78
d	64	74	64	45	45	45
Ø e	5.5	4.3	5.5	5.5	5.5	5.5
f	12	12	7	7	7	7
g	80	88	90	100	100	101
h	128	145	129	138	138	139
i	-	-	-	13	13	13
Conductor mm² min	1.5	1.5	1.5	2.5	2.5	2.5
Conductor mm² max	4	4	4	10	10	10

Panel Mounting Appliance Inlet

 Watertight

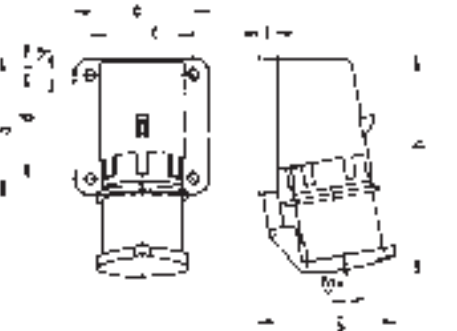

Amperes	16			32		
Poles	3	4	5	3	4	5
a	74	75	84	90	90	90
b	84	100	84	75	75	75
c	58	62	64	78	78	78
d	64	74	64	45	45	45
Ø e	5.5	4.3	5.5	5.5	5.5	5.5
f	12	12	29	29	29	29
g	78	88	105	114	114	115
h	134	151	138	149	149	150
i	-	-	-	13	13	13
Conductor mm² min	1.5	1.5	1.5	2.5	2.5	2.5
Conductor mm² max	4	4	4	10	10	10

Panel Mounting Appliance Inlet

With hinged lid

 Splashproof

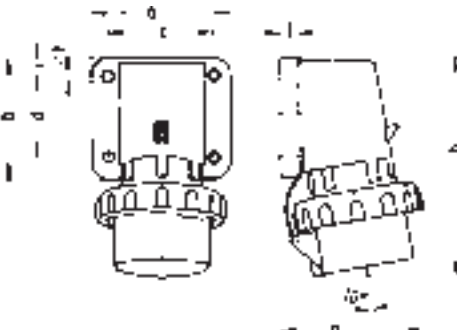

Amperes	16			32		
Poles	3	4	5	3	4	5
a	74	75	84	90	90	90
b	84	100	84	75	75	75
c	58	62	64	78	78	78
d	64	74	64	45	45	45
Ø e	5.5	4.3	5.5	5.5	5.5	5.5
f	12	12	7	7	7	7
g	80	88	90	100	100	101
h	133	152	134	147	147	148
i	-	-	-	13	13	13
Conductor mm² min	1.5	1.5	1.5	2.5	2.5	2.5
Conductor mm² max	4	4	4	10	10	10

Panel Mounting Appliance Inlet

With fastening cap

 Watertight

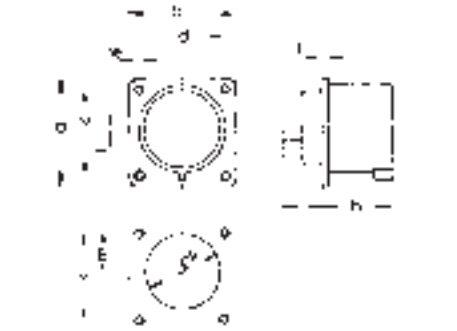



Amperes	16			32		
Poles	3	4	5	3	4	5
a	75	75	75	75	75	75
b	75	75	75	75	75	75
c	60	60	60	60	60	60
d	60	60	60	60	60	60
Ø e	5.5	5.5	5.5	5.5	5.5	5.5
f	7	7	7	7	7	7
h	43	43	43	53	53	53
i	24	24	24	30	30	30
k	42	48	61	57	57	60
m	30	30	25	28	28	30
Conductor mm² min	1.5	1.5	1.5	2.5	2.5	2.5
Conductor mm² max	4	4	4	10	10	10

Panel Mounting Appliance Inlet



 Splashproof

A retaining nose on panel for the connector is recommended

A	V	Hz		EARTH HR. POS		EARTH HR. POS		EARTH HR. POS
CURRENT	VOLTAGE	FREQUENCY	2P+E		3P+E		3P+N+E	

Appliance Inlets





16 	110	50 - 60	2705	4	2708	4	2755	4
	240	50 - 60	2706	6	2709	9	2756	9
	415	50 - 60	2707	9	2751	6	2757	6
32 	110	50 - 60	2758	4	2761	4	2767	4
	240	50 - 60	2759	6	2762	9	2768	9
	415	50 - 60	2760	9	2763	6	2769	6
63 	110	50 - 60	2770	4	2773	4	2779	4
	240	50 - 60	2771	6	2774	9	2780	9
	415	50 - 60	2772	9	2775	6	2781	6



Panel Mounting Appliance Inlet

 Splashproof

10° Angle

16 	110	50 - 60	2782	4	2785	4	2791	4
	240	50 - 60	2783	6	2786	9	2792	9
	415	50 - 60	2784	9	2787	6	2793	6
32 	110	50 - 60	2794	4	2797	4	27003	4
	240	50 - 60	2795	6	2798	9	27004	9
	415	50 - 60	2796	9	2799	6	27005	6
63 	110	50 - 60	27006	4	27009	4	27015	4
	240	50 - 60	27007	6	27010	9	27016	9
	415	50 - 60	27008	9	27011	6	27017	6



Panel Mounting Appliance Inlet

 Watertight

10° Angle

125 	110	50 - 60	2735	4	2738	4	2742	4
	240	50 - 60	2736	6	2739	9	2743	9
	415	50 - 60	2737	9	2740	6	2744	6



Panel Mounting Appliance Inlet

 Watertight

15° Angle

63 	110	50 - 60	2880	4				
	240	50 - 60	2834	6				
	415	50 - 60			2833	6	2837	6



Panel Mounting Appliance Inlet Straight

 Splashproof

As above but

 Watertight

63 	110	50 - 60	2881	4				
	240	50 - 60	2835	6				
	415	50 - 60			2836	6	2838	6

125 	110	50 - 60	2882	4				
	240	50 - 60	2860	6				
	415	50 - 60			2861	6	2876	6



Panel Mounting Appliance Inlet Straight

 Watertight

16A and 32A with screw terminals

63A and 125A with screw / clamp terminals and pilot contact

Note: This pilot contact should **NOT** be counted as a main 'pin'

Dimensions

Amperes	16			32			63		
	3	4	5	3	4	5	3	4	5
Poles									
a	85	85	85	85	85	85	107	107	107
b	85	85	85	85	85	85	100	100	100
c	70	70	70	70	70	70	85	85	85
d	70	70	70	70	70	70	77	77	77
e	6.3	6.3	6.3	6.3	6.3	6.3	6.5	6.5	6.5
f	11	11	11	11	11	11	12	12	12
g	104	110	116	121	121	127	155	155	155
i	83	90	92	96	96	100	118	118	118
Conductor mm ² min	1.5	1.5	1.5	2.5	2.5	2.5	4	4	4
Conductor mm ² max	4	4	4	10	10	10	16	16	16

Amperes	16			32			63		
	3	4	5	3	4	5	3	4	5
Poles									
a	85	85	85	85	85	85	107	107	107
b	85	85	85	85	85	85	100	100	100
c	70	70	70	70	70	70	85	85	85
d	70	70	70	70	70	70	77	77	77
e	6.3	6.3	6.3	6.3	6.3	6.3	6.5	6.5	6.5
f	11	11	11	11	11	11	12	12	12
h	104	110	116	121	121	127	155	155	155
i	83	90	92	96	96	100	118	118	118
k	70.5	79.5	86.5	95	95	101.5	113.5	113.5	113.5
Conductor mm ² min	1.5	1.5	1.5	2.5	2.5	2.5	4	4	4
Conductor mm ² max	4	4	4	10	10	10	16	16	16

Amperes	125		
	3	4	5
Poles			
a	130	130	130
b	120	120	120
c	108	108	108
d	100	100	100
e	6.3	6.3	6.3
f	5	5	5
h	31	31	31
i	132	132	132
k	98	98	98
Conductor mm ² min	25	25	25
Conductor mm ² max	70	70	70

Amperes	125		
	3	4	5
Poles			
a	110	110	110
b	106	106	106
c	90	90	90
d	90	90	90
Ø e	5.5	5.5	5.5
f	13	13	13
h	96	96	96
i	19	19	19
Conductor mm ² min	6	6	6
Conductor mm ² max	25	25	25

Appliance Inlet with Flange







 Splashproof

A retaining nose on panel for the connector is recommended

As above but



 Watertight

Amperes	125		
	3	4	5
Poles			
a	120	120	120
b	120	120	120
c	100	100	100
d	100	100	100
Ø e	6.5	6.5	6.5
f	13	13	13
h	116	116	116
i	20	20	20
k	104	104	104v
Conductor mm ² min	25	25	25
Conductor mm ² max	70	70	70

A CURRENT	V VOLTAGE	Hz FREQUENCY	 2P+E	 EARTH HR. POS	 3P+E	 EARTH HR. POS	 3P+N+E	 EARTH HR. POS
--------------	--------------	-----------------	--	---	--	---	--	---

Appliance Inlets

CEE **NORM**

16 	110	50 - 60		4		4		4
	240	50 - 60	2899	6		9		9
	415	50 - 60		9	28101	6	28103	6
32 	110	50 - 60		4		4		4
	240	50 - 60	28105	6		9		9
	415	50 - 60		9	28107	6	28109	6



Panel Mounting Appliance Inlet

 Watertight

Straight

Cover for Appliance Inlet & Plugs

(Suitable for Watertight IP67 only)

Part No.	
830	Cover for 16A 3P W/T A.I./plug
831	Cover for 16A 5P W/T A.I./plug
832	Cover for 32A 5P W/T A.I./plug
833	Cover for 63A W/T A.I./plug
834	Cover for 125A W/T A.I./plug
835	Cover for 16A 4P W/T A.I./plug
837	Cover for 32A 3P4P W/T A.I./plug

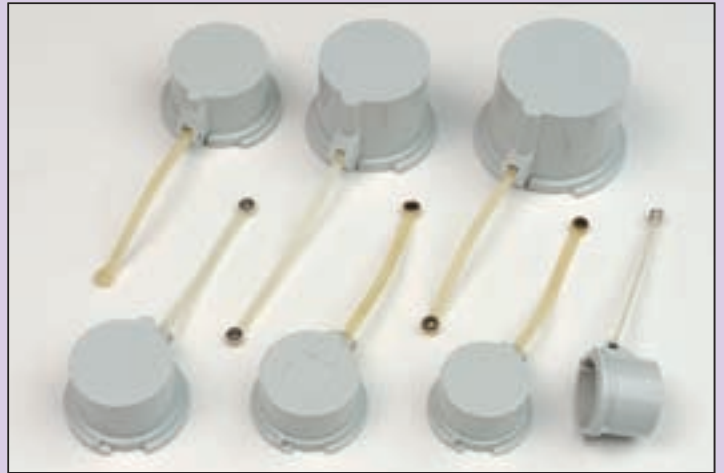

Other voltages and frequencies are available on request. Contact CEE Norm UK for further details

Dimensions

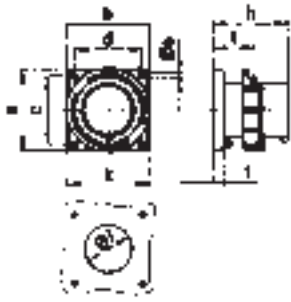

Amperes	16			32		
Poles	3	4	5	3	4	5
a	85	85	85	85	85	85
b	85	85	85	85	85	85
c	70	70	70	70	70	70
d	70	70	70	70	70	70
Ø e	6.3	6.3	6.3	6.3	6.3	6.3
f	11	11	11	11	11	11
h	75.5	75	76.5	85	85	85
i	44	44	44	44	44	44
k	70.5	78.5	86.5	94	94	101.5
Ø 1	49	49	49	49	49	49
Conductor mm ² min	1	1	1	2.5	2.5	2.5
Conductor mm ² max	2.5	2.5	2.5	6	6	6

Connectors (Couplers)

16A and 32A IP44 connectors on page 58 are fitted with screw terminals, one piece bodies with Multi-Grip cable glands/except angled connectors.

16A and 32A IP67 connectors on page 60 are fitted with QUICK-CONNECT terminals, screw together bodies and Multi-Grip cable glands.

63A and 125A IP67 connectors on page 60 are fitted with screw/clamp terminals, screw together bodies and Multi-Grip cable glands.

For QUICK-CONNECT connectors IP44
16A - 63A see page 72.

Connectors (Couplers)



Chemical and Heavy Industry



Harbour installation containers, ship yards and shipping lines

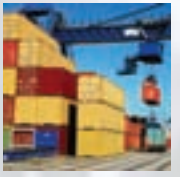

Mining and tunnelling

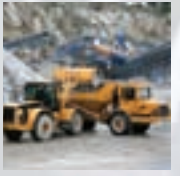

Camping and caravanning



Building and construction industry



Food processing and packaging

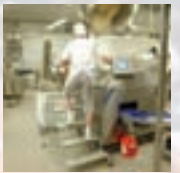

Agriculture and farming

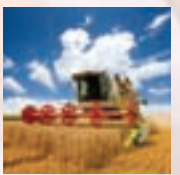

Military applications



Industrial and commercial properties



Power generation and distribution



Oil and gas (non hazardous areas)

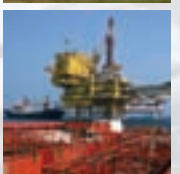

Film, TV and outdoor events

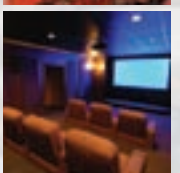

Connectors (Couplers)



- Screwless QUICK-CONNECT cage clamp terminals
- Simple housing connection through pressure screw-thread connection
- Opening and closing by simply turning around 90°
- The tensile strength of the 4-point (quarter turn) locking system is over 2400 N for 16A, and over 4700 N for 32A



- Multi-Grip cable gland
- Rubber seal, firmly moulded on, facilitates connection
- No additional seals and rings required
- 18 flexible laminae adapt to the cable diameter
- The Multi-Grip screw connection achieves a high tensile strength whilst simultaneously protecting the cable



- QUICK-CONNECT 16A and 32A IP44 connector housings
- Lock engages automatically and securely on closing
- Lock can be opened by turning clockwise with a screwdriver
- QUICK-CONNECT 16A and 32A IP67 connectors have two sealing screws to secure the contact carrier to the housing
- 63A and 125A connectors have screw-together housings

Safe, Robust, Easy to Install

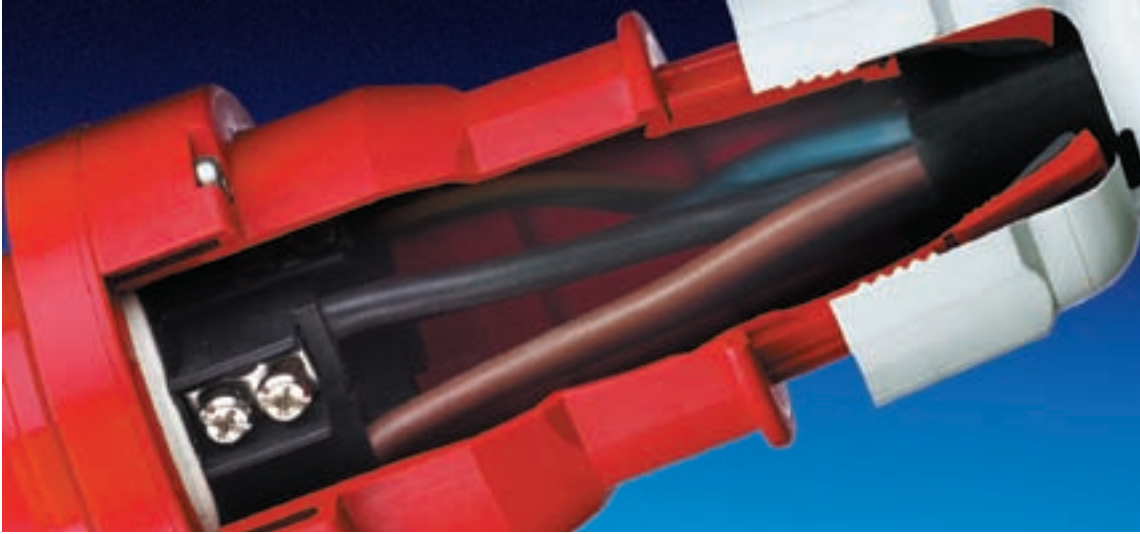

- Generous connection space
- No awkward strain relief, due to Multi-Grip cable gland
- Cage clamp terminals with 16A and 32A (or screw terminals are available)
- Screw / clamp terminals for 63A and 125A
- 16A and 32A short and long cable sleeve connectors on page 54 (non QUICK-CONNECT) are fitted with internal cable grip



- KONTEX-PLUS - very good contact rating results
- Self-cleaning
- Defined contact operation
- Almost unchanging with drawing forces
- Excellent heat dissipation
- High copper content guarantees good current flow



- Fibre glass-reinforced and particularly temperature resistant contact carriers
- Brass-nickel-plated screw / clamp terminals for 63A and 125A
- Cable ferrules are not necessary
- Even contact pressure
- Minimised transition resistance



- QUICK-CONNECT tension spring clamping technology for 16A and 32A (or screw terminals are available)
- Brass-nickel-plated screw / clamp terminals for 63A and 125A
- Accommodation of large cable cross-sections
- Even contact pressure with minimised transition resistance

A	V	Hz	2P+E	EARTH HR. POS	3P+E	EARTH HR. POS	3P+N+E	EARTH HR. POS
---	---	----	------	---------------	------	---------------	--------	---------------

Connectors



16	110	50 - 60	31000-TLS	4	31003-TLS	4	31009-TLS	4
	240	50 - 60	31001-TLS	6	31004-TLS	9	31010-TLS	9
	415	50 - 60	31002-TLS	9	31005-TLS	6	303-TLS	6
32	110	50 - 60	31012-TLS	4	31015-TLS	4	31021-TLS	4
	240	50 - 60	31013-TLS	6	31016-TLS	9	31022-TLS	9
	415	50 - 60	31014-TLS	9	31017-TLS	6	304-TLS	6



Connector with Multi-Grip Cable Gland

- One Piece Body
- Splashproof

16		240	50 - 60	330	6			
----	--	-----	---------	-----	---	--	--	--

16A and 32A with screw terminals



Angled Connector with Short Cable Sleeve

- Splashproof

63	110	50 - 60	3108	4	3149	4	3153	4
	240	50 - 60	3104	6	3150	9	3154	9
	415	50 - 60	3109	9	3151	6	3112	6

63A with screw / clamp terminals and pilot contact

Note: This pilot contact should **NOT** be counted as a main 'pin'



Connector with Multi-Grip Cable Gland

- Screw / clamp terminals
- Splashproof

All items on this page have screw terminals.
125A is only available in IP67 see page 60.

Dimensions

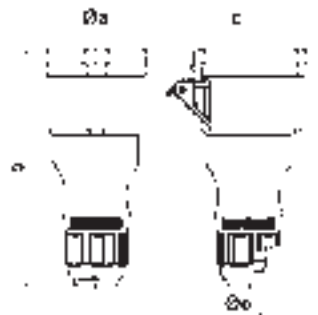

	16			32		
	3	4	5	3	4	5
Amperes						
Poles						
Ø a	51	58	65	67	67	73
b	145	148	156	185	185	185
c	74	84	90	94	94	102
Ø e	18	18	18	23	23	23
Conductor mm ² min	1	1	1	2.5	2.5	2.5
Conductor mm ² max	2.5	2.5	2.5	6	6	6

Connector with Multi-Grip Cable Gland

- Screw terminals

 Splashproof

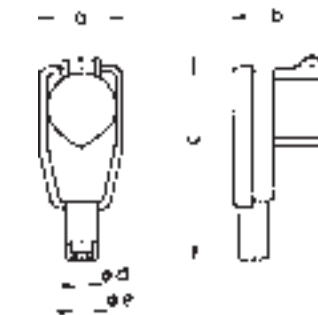

	16
Amperes	
Poles	3
a	54
b	79
c	139
Ø d	6.5
Ø e	13
Conductor mm ² min	1.5
Conductor mm ² max	2.5

Angled Connector with Short Cable Sleeve

 Splashproof





	63		
	3	4	5
Amperes			
Poles			
Ø a	95	95	95
b	263	263	263
c	109	109	109
Ø d	36	36	36
Conductor mm ² min	6	6	6
Conductor mm ² max	16	16	16

Connector with Multi-Grip Cable Gland



- Multi-Grip cable gland system with moulded-in gasket
- High temperature resistant contact carrier
- Screw / clamp terminals
- Nickel plated contacts

 Splashproof

A	V	Hz		EARTH HR. POS		EARTH HR. POS		EARTH HR. POS
CURRENT	VOLTAGE	FREQUENCY	2P+E		3P+E		3P+N+E	

Connectors

CEE **NORM**

16 	110	50 - 60	31298	4	31301	4	31305	4
	240	50 - 60	31240	6	31302	9	31306	9
	415	50 - 60	31299	9	31241	6	31243	6
32 	110	50 - 60	31307	4	31309	4	31313	4
	240	50 - 60	31244	6	31310	9	31314	9
	415	50 - 60	31308	9	31245	6	31247	6



Connector
QUICK-CONNECT[®]
with **Multi-Grip**
Cable Gland

 Watertight

QUICK-CONNECT[®]

The range of **QUICK-CONNECT** products are shown on pages **42, 60, 92, 102**

63 	110	50 - 60	3180	4	3183	4	3187	4
	240	50 - 60	3181	6	3184	9	3188	9
	415	50 - 60	3182	9	3185	6	3124	6



Connector
with **Multi-Grip**
Cable Gland

 Watertight

Screw / clamp terminals

125 	110	50 - 60	3190	4	3193	4	3197	4
	240	50 - 60	3191	6	3194	9	3198	9
	415	50 - 60	3192	9	3195	6	3199	6



Connector
with **Multi-Grip**
Cable Gland

 Watertight

Screw / clamp terminals

63A and 125A with screw / clamp terminals and pilot contact

Note: This pilot contact should **NOT** be counted as a main 'pin'

All items on this page are IP67 watertight

Dimensions

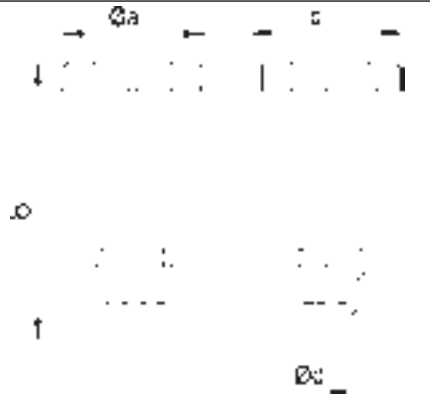

	16			32		
	3	4	5	3	4	5
Ø a	70.5	78	86.5	94	94	101.5
b	161	161	168	196	196	200
c	77	83	93	99	99	107
Ø d	18	18	21	23	23	27
Conductor mm ² min	1	1	1	2.5	2.5	2.5
Conductor mm ² max	2.5	2.5	2.5	6	6	6

Connector QUICK CONNECT[®] with Multi-Grip Cable Gland

- Screwless terminals
 - Multi-Grip cable gland system with moulded-in gasket
 - Nickel-plated contacts
 - High temperature resistant contact carrier
-  Watertight



	63		
	3	4	5
Ø a	110	110	110
b	263	263	263
c	113	113	113
Ø d	36	36	36
Conductor mm ² min	6	6	6
Conductor mm ² max	16	16	16

Connector with Multi-Grip Cable Gland

- Multi-Grip cable gland system with moulded-in gasket
 - High temperature resistant contact carrier
 - Screw / clamp terminals
 - Nickel-plated contacts
-  Watertight

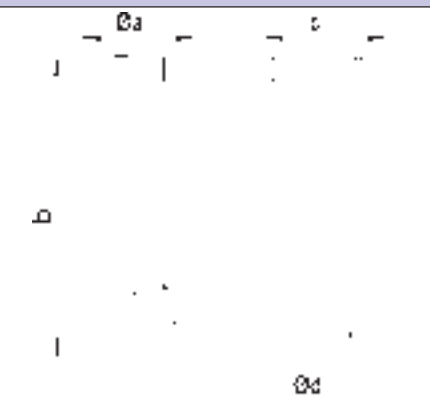

	125		
	3	4	5
Ø a	125	125	125
b	300	300	300
c	128	128	128
Ø d	50	50	50
Conductor mm ² min	16	16	16
Conductor mm ² max	50	50	50

Connector with Multi-Grip Cable Gland

- Multi-Grip cable gland system with moulded-in gasket
 - High temperature resistant contact carrier
 - Screw / clamp terminals
 - Nickel-plated contacts
-  Watertight

Notes:

QUICK CONNECT[®]

For on-site savings up to **50%**



Socket Outlets

page 66

Plugs

page 70

Connectors

page 72

Additional **QUICK  CONNECT[®]** products can be found on pages: **42, 60, 92 and 102**

Chemical and Heavy Industry



Harbour installation containers, ship yards and shipping lines



Mining and tunnelling

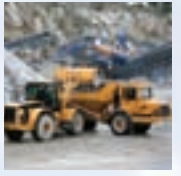

Camping and caravanning



Building and construction industry



Food processing and packaging

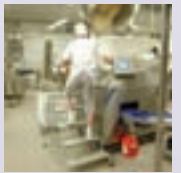

Agriculture and farming

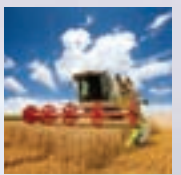

Military applications



Industrial and commercial properties

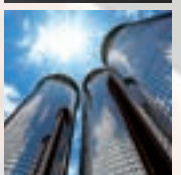

Power generation and distribution



Oil and gas (non hazardous areas)

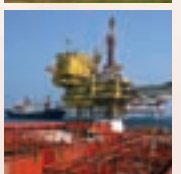

Film, TV and outdoor events

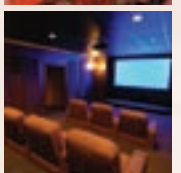

QUICK CONNECT[®]

The product that sets new industry standards

A latest generation of products providing quality and performance with unique time saving fully screwless installation techniques.

The unique combination of screw-less terminations and quick release housings guarantees that our latest range of QUICK-CONNECT plugs and connectors require the minimum time for wiring original installations and emergency repair jobs.

Plug and socket connectors assembly 16A and 32A



Terminal housing with appropriate plug or socket connectors are supplied loosely connected (not locked) for immediate start and time saving.

Quick, positive and fully protected

IP67 protection available. IP67 has two sealing screws to secure the contact carrier to the housing.



Insert cable through cable sleeve and strip cable and conductors.

New automatic cable clamping for 16A and 32A sleeved plugs and connectors

The action of twisting the housings together automatically forces an internal cage moulding into a tapered conical area which securely clamps the cable into position. No time wasting saddle clamp screws to be tightened, with a permanent and positive high pull-out load always being maintained.



Insert conductor into appropriate terminal and push down the colour coded contact slides to clamp conductor securely into position (slides coloured in accordance with current wiring regulations).



To join housings, line-up arrowhead moulded into rim of plug / socket housings with the 'open lock' symbol on the terminal housing. Push housings together and twist 10° until they click into the locked position. Four catches now securely hold the housings together.

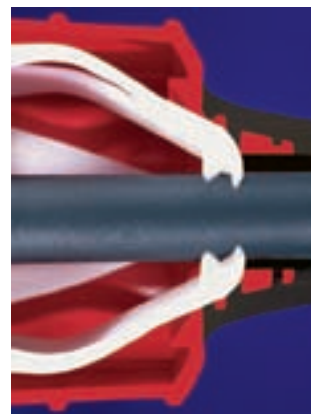

Automatic cable clamping guarantees positive pull-out load.

QUICK CONNECT[®]



To open housings

To open housings simply insert screwdriver blade into slot alongside the 'closedlock' symbol moulded onto rim of terminal housing. Depress catch and twist housings 10° in opposite directions, then pull apart.

To release cable terminations, simply lift contact slides.

Nothing could be easier, simpler or quicker.

Our QUICK-CONNECT range of industrial plugs and sockets has been extended to cover both 16 and 32amp sizes. In addition, the design has been developed to become even quicker to install, showing even greater savings for on-site tasks.

Our unique screwless cable termination system has now been supplemented with an automatic cable clamping feature (no saddle clamp screws to tighten or lose). In addition, our twist to connect/disconnect housings feature a simple press-to-release opening with a secure 4 point locking feature that can give up to IP55 protection.

When fitting panel mounted sockets to enclosures, the length of cable tails can now also be accurately determined, showing appreciable savings on wasted cable. QUICKCONNECT now requires the minimum wiring time for any comparable product.

- **Quick release housings**
- **Screwless terminals**
- **Automatic cable clamping**
- **Maintenance free**
- **Shock & vibration resistant**
- **Corrosion protected**
- **16A and 32A: 3/4/5 pole**
- **Up to IP67 protection**





Lift contact slide to release cable.





Contacts

- Self cleaning corrosion resistant nickel contacts
- Corrosion-free spring
- Low insert and withdrawal forces
- Defined conductivity
- Increased copper content guarantees better conductivity and lower temperature rise

A	V	Hz		EARTH HR. POS		EARTH HR. POS		EARTH HR. POS	Socket Outlets	
CURRENT	VOLTAGE	FREQUENCY	2P+E		3P+E		3P+N+E			

CEE **NORM**

16 	110	50 - 60	11912	4					
	240	50 - 60	11895	6					
	415	50 - 60			11905	6	112001	6	
32 	110	50 - 60	11918	4					
	240	50 - 60	11919	6					
	415	50 - 60			11922	6	112002	6	



QUICK CONNECT
Surface Mounting Socket Outlet
Top Cable Entry Only
 Splashproof

32 	110	50 - 60	11948	4					
	240	50 - 60	11949	6					
	415	50 - 60			11956	6	11962	6	



QUICK CONNECT
Surface Mounting Socket Outlet
Top & Bottom Cable Entry
 Splashproof

63 	110	50 - 60							
	240	50 - 60							
	415	50 - 60			110415	6	110383	6	



QUICK CONNECT
Surface Mounting Socket Outlet
Top & Bottom Cable Entry
 Splashproof

QUICK CONNECT[®]

Other voltages and frequencies are available on request. Contact CEE Norm UK for further details

Dimensions

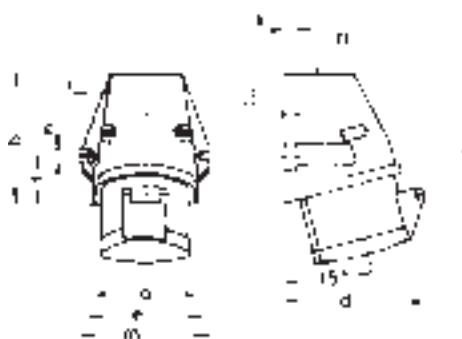

Amperes	16			32		
Poles	3	4	5	3	4	5
a	59.5	72.4	72.4	79.1	79.1	79.1
b	90	90	90	92	92	92
c	130	130	131	142	142	142
d	85	96	98	103	103	106
e	62	77	77	84	84	84
f	33.5	33.5	33.5	30	30	30
h	9	9	9	9	9	9
i	5.5	5.5	5.5	5.5	5.5	5.5
k	8	9	9	9	9	9
Ø l	21	21	21	21	21	21
m	72	87	87	94	94	94
n	M20	M25	M25	M25	M25	M25
Conductor mm ² min	1.5	1.5	1.5	2.5	2.5	2.5
Conductor mm ² max	4	4	4	10	10	10

QUICK CONNECT[®] Surface Mounting Socket Outlet

- Screwless terminals maintenance free
- Cable entry, one at top (open)

 Splashproof

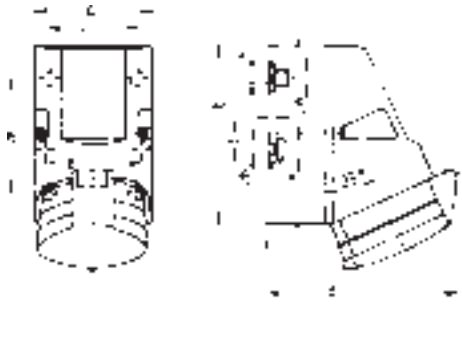

Amperes	32		
Poles	3	4	5
a	83	83	83
b	126	126	126
c	155	155	155
d	130	130	136
e	68	68	68
f	11	11	11
Ø h	5.5	5.5	5.5
i	6.5	6.5	6.5
Ø k	12	12	12
l	65	65	65
m	80	80	80
Ø n	10	10	10
o	M25	M25	M25
p	2xM25	2xM25	2xM25
Conductor mm ² min	2.5	2.5	2.5
Conductor mm ² max	10	10	10

QUICK CONNECT[®] Surface Mounting Socket Outlet

- Screwless terminals maintenance free
- Cable entry, one at top (open), two at bottom and one rear entry (closed)
- Base of enclosure can rotate 180°
- 4 drill-holes prestamped in the base of enclosure

 Splashproof

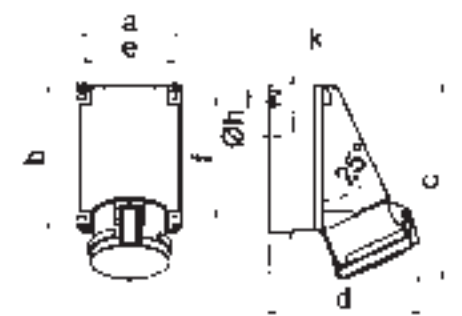

Amperes	63	
Poles	4	5
a	118	118
b	170	170
c	223	223
d	168	168
e	104	104
f	136	136
Ø h	6.1	6.1
i	6	6
k	M40	M40
l	M32/32	M32/32
Conductor mm ² min	6	6
Conductor mm ² max	25	25



QUICK CONNECT[®] Surface Mounting Socket Outlet

- Screwless terminals maintenance free
- Cable entry, one at top (open), two at bottom (closed)

 Splashproof

A CURRENT	V VOLTAGE	Hz FREQUENCY	 2P+E	EARTH HR. POS  3P+E	EARTH HR. POS  3P+N+E	Socket Outlets		
--------------	--------------	-----------------	---	--	--	----------------	--	--

CEE NORM

16 	110	50 - 60	12771	4				
	240	50 - 60	12772	6				
	415	50 - 60			12753	6	12757	6
32 	110	50 - 60	12760	4				
	240	50 - 60	12761	6				
	415	50 - 60			12764	6	12768	6





QUICK CONNECT®
**Panel Mounting
 Socket Outlet**
 Splashproof
 20° Angle

16 	110	50 - 60	13667	4				
	240	50 - 60	13668	6				
	415	50 - 60						



QUICK CONNECT®
**Panel Mounting
 Socket Outlet**
 Splashproof
 Straight

16 	110	50 - 60	13685	4				
	240	50 - 60	13686	6				
	415	50 - 60			13693	6	132001	6
32 	110	50 - 60	13702	4				
	240	50 - 60	13703	6				
	415	50 - 60			13710	6	132002	6



QUICK CONNECT®
**Panel Mounting
 Socket Outlet**
 Splashproof
 Straight Flange 75 x 75mm

QUICK CONNECT®

Other voltages and frequencies are available on request. Contact CEE Norm UK for further details

Dimensions



Amperes	16			32		
Poles	3	4	5	3	4	5
a	74	85	85	85	85	85
b	62	85	85	85	85	85
c	60	70	70	70	70	70
d	52	70	70	70	70	70
ø e	5.5	5.5	5.5	5.5	5.5	5.5
f	8	8	8	8	8	8
h	46	46	46	61	61	61
i	48	58	60	68	68	69
k	57	-	-	-	-	-
l	52	65	70	78	78	78
a	20°	20°	20°	20°	20°	20°
Conductor mm ² min	1.5	1.5	1.5	2.5	2.5	2.5
Conductor mm ² max	4	4	4	10	10	10

QUICK CONNECT® Panel Mounting Socket Outlet

- Screwless terminals maintenance free
- 20° angle
- 2Flange 74 x 62mm at 16A 3P, 85 x 85mm for the other versions

 Splashproof

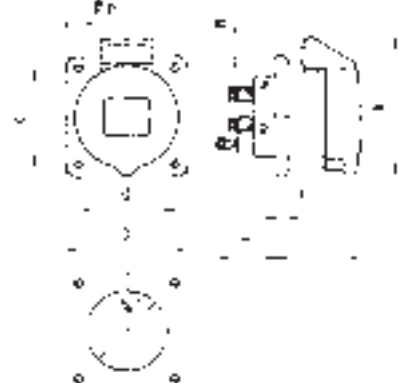

Amperes	16
Poles	3
a	62
b	62
c	47
d	47
ø e	5.5
f	7
h	35.5
i	51
k	70
ø l	45
m	10
Conductor mm ² min	1.5
Conductor mm ² max	4

QUICK CONNECT® Panel Mounting Socket Outlet

- Screwless terminals maintenance free
- Flange 62 x 62mm at 16A 3P

 Splashproof

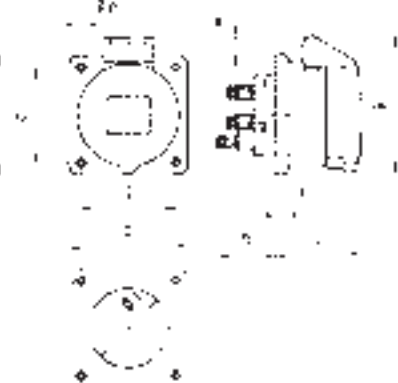

Amperes	16			32		
Poles	3	4	5	3	4	5
a	75	75	75	75	75	75
b	75	75	75	75	75	75
c	60	60	60	60	60	60
d	60	60	60	60	60	60
ø e	5.5	5.5	5.5	5.5	5.5	5.5
f	7	7	7	8	8	8
h	35.5	35.5	35.5	50	50	50
i	51	53	53	62	62	62
k	70	80	85	90	90	98
ø l	45	45	55	60	60	60
m	3.5	7	11.5	12	12	17
Conductor mm ² min	1.5	1.5	1.5	2.5	2.5	2.5
Conductor mm ² max	4	4	4	10	10	10

QUICK CONNECT® Panel Mounting Socket Outlet

- Screwless terminals maintenance free
- Flange 75 x 75mm

 Splashproof

A	V	Hz		EARTH HR. POS		EARTH HR. POS		EARTH HR. POS
CURRENT	VOLTAGE	FREQUENCY	2P+E		3P+E		3P+N+E	

CEE NORM

Plugs

16	110	50 - 60	210100	4				
	240	50 - 60	210094	6				
	415	50 - 60			210095	6	212001	6
32	110	50 - 60	210330	4				
	240	50 - 60	210096	6				
	415	50 - 60			210097	6	212002	6



QUICK CONNECT®
Plug with Cable Sleeve

- Screwless terminals

 Splashproof

16	110	50 - 60	2125	4	21872	4	210176	4
	240	50 - 60	2126	6	2129	9	21840	9
	415	50 - 60	21843	9	2130	6	2136	6
32	110	50 - 60	2137	4	21873	4	210193	4
	240	50 - 60	2138	6	2141	9	21842	9
	415	50 - 60	21844	9	2142	6	2148	6



QUICK CONNECT®
Plug with Multi-Grip Cable Gland

- Screwless terminals

 Splashproof

63	110	50 - 60						
	240	50 - 60						
	415	50 - 60			210761	6	210765	6

63A with screwless terminals and pilot contact
Note: This pilot contact should **NOT** be counted as a main 'pin'



QUICK CONNECT®
Plug with Multi-Grip Cable Gland

- Screwless terminals

Splashproof



QUICK CONNECT®

Other voltages and frequencies are available on request. Contact CEE Norm UK for further details

Dimensions



	16			32		
	3	4	5	3	4	5
Amperes						
Poles						
Ø a	53	59	66	70	70	75
b	125.5	133	141	165	165	165
c	86.5	96.5	104.5	119	119	119
Ø d	5	5	7	8	8	8.5
Ø e	14.5	15.5	17.5	23.5	23.5	26
Conductor mm ² min	1	1	1	2.5	2.5	2.5
Conductor mm ² max	2.5	2.5	2.5	6	6	6

QUICK CONNECT[®] Plug

- Moulded cable sleeve
- 4-point (quarter turn) locking system
- Screwless terminals

 Splashproof

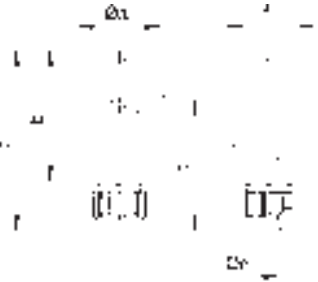

	16			32		
	3	4	5	3	4	5
Amperes						
Poles						
Ø a	53	60	66	74.5	74.5	74.5
b	93.5	100.5	103	121	121	121.5
c	134	141	142	174	174	174.5
d	97.5	104.5	105.5	128	128	128.5
Ø e	18	18	18	23	23	23
f	57.5	64.5	70.5	78	78	80
Conductor mm ² min	1	1	1	2.5	2.5	2.5
Conductor mm ² max	2.5	2.5	2.5	6	6	6

QUICK CONNECT[®] Plug with Multi-Grip Cable Gland

- Screwless terminals
- 4-point (quarter turn) locking system
- Multi-Grip cable gland system with moulded-in gasket

 Splashproof

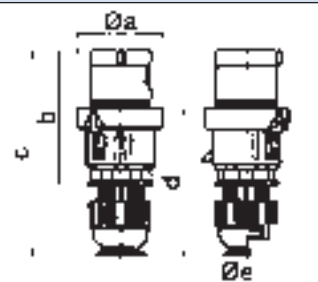

	63	
	4	5
Amperes		
Poles		
Ø a	96	96
b	153	153
c	233	233
d	167	167
Ø e	36	36
Conductor mm ² min	6	6
Conductor mm ² max	16	16

QUICK CONNECT[®] Plug with Multi-Grip Cable Gland

- Multi-Grip cable gland system with moulded-in gasket
- Max cable diameter 36mm
- Screwless terminals

 Splashproof

Connectors

16	110	50 - 60	31886	4				
	240	50 - 60	31880	6				
	415	50 - 60			31881	6	312001	6
32	110	50 - 60	310085	4				
	240	50 - 60	31882	6				
	415	50 - 60			31883	6	312002	6



QUICK CONNECT[®]
Connector with Cable Sleeve

- Screwless terminals
-  Splashproof

16	110	50 - 60	3125	4	31681	4	31962	4
	240	50 - 60	3126	6	3129	9	31662	9
	415	50 - 60	31665	9	3130	6	3136	6
32	110	50 - 60	3137	4	31973	4	31979	4
	240	50 - 60	3138	6	3141	9	31664	9
	415	50 - 60	31666	9	3142	6	3148	6



QUICK CONNECT[®]
Connector with Multi-Grip Cable Gland

- Screwless terminals
-  Splashproof

63	110	50 - 60						
	240	50 - 60						
	415	50 - 60			310490	6	310494	6

63A with screwless terminals and pilot contact

Note: This pilot contact should **NOT** be counted as a main 'pin'



QUICK CONNECT[®]
Connector with Multi-Grip Cable Gland

- Screwless terminals
-  Splashproof

Dimensions



Amperes	16			32		
	3	4	5	3	4	5
Poles						
Ø a	53	58	64	66	66	74
b	142	147	156.5	181	181	181
Ø c	5	5	7	8	8	8.5
Ø d	14.5	15.5	17.5	23.5	23.5	26
e	72	78	85	90	90	99
Conductor mm ² min	1	1	1	2.5	2.5	2.5
Conductor mm ² max	2.5	2.5	2.5	6	6	6

QUICK CONNECT[®] Connector

- Moulded cable sleeve
- 4-point (quarter turn) locking system
- Screwless terminals

 Splashproof

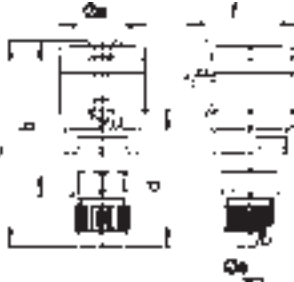

Amperes	16			32		
	3	4	5	3	4	5
Poles						
Ø a	53	60	66	74.5	74.5	74.5
b	104.5	116.5	117.5	137.5	137.5	138.5
c	145	157	158	190	190	191
d	97.5	104.5	105.5	127.5	127.5	128.5
Ø e	18	18	18	23	23	23
f	69	79	86	92	92	97
Conductor mm ² min	1	1	1	2.5	2.5	2.5
Conductor mm ² max	2.5	2.5	2.5	6	6	6

QUICK CONNECT[®] Connector with Multi-Grip Cable Gland

- Screwless terminals
- 4-point (quarter turn) locking system
- Multi-Grip cable gland system with moulded-in gasket

 Splashproof

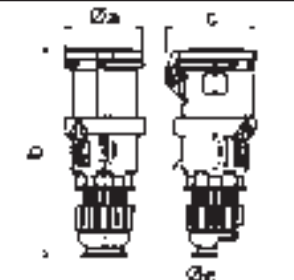

Amperes	63	
	4	5
Poles		
Ø a	95	95
b	251	251
c	109	109
Ø d	36	36
Conductor mm ² min	6	6
Conductor mm ² max	16	16

QUICK CONNECT[®] Connector with Multi-Grip Cable Gland

- Multi-Grip cable gland system with moulded-in gasket
- Max cable diameter 36mm
- Screwless terminals
- Nickel plated contacts

 Splashproof

Notes:

Low Voltage



Surface Mounting Socket Outlets	page 78
Panel Mounting Socket Outlets	page 78
Surface Mounting Appliance Inlets	page 80
Plugs	page 80
Connectors	page 80

Chemical and Heavy Industry



Harbour installation containers, ship yards and shipping lines

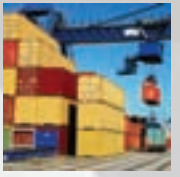

Mining and tunnelling

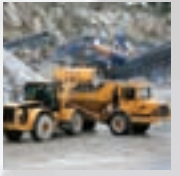

Camping and caravanning

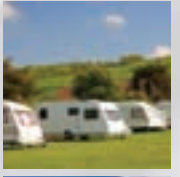

Building and construction industry

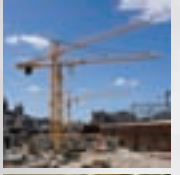

Food processing and packaging

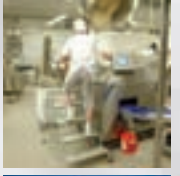

Agriculture and farming

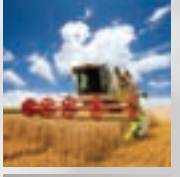

Military applications



Industrial and commercial properties



Power generation and distribution



Oil and gas (non hazardous areas)

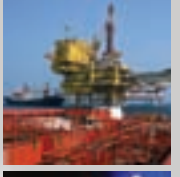

Film, TV and outdoor events

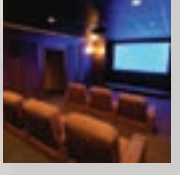

Low Voltage Plugs and Sockets



- Connection of different cable diameters possible through additional strain relief
- Strain relief with metric screws



- Wall socket for through-wiring
- Generous connection space
- Removable socket insert facilitates connection
- Rotatable base (180°)
- Compact construction



- Clear voltage identification through colour coding



- Plugs and couplers available with cable gland connection or long cable sleeve

Low voltage products have screw terminals

Safe, Robust, Easy to Install

- Low voltage plug-type devices 63A
- Manufactured based on CEE regulations in terms of form and safety
- Based on conventional plug-type devices
- Highly heat-resistant contact carrier



Low voltage devices 63A to 50V and frequencies up to 500Hz

Arrangement overview of the contact bushes

Frequency	50 & 60	50 & 60	110 - 200	300	400	401 - 500	500	Hz
Operating voltage	20 - 25	40 - 50	40 - 50	up to 50	up to 50	up to 50	up to 50	V
1) ● ø9 L ○ ø8 L2								2 pins
2) ● ø9 L ○ ø8 L2 L3								3 pins
3) ○ ø8 L1 L2 L3								3 pins
ID colour	6 h violet	12 h white	4 h green	7 h green	3 h green	1' h green	10 h grey	

According to DIN VDE 0100, for certain application areas the protective measure of low voltage or fuse disconnection is prescribed, such as e.g. mobile lamps in an environment of conductive materials (boilers, pipework or portable wet grinding machines etc). See DIN VDE 0100/5.73 sections 33, 34 part 706/11.82, part 410/11.83.

The standard DIN/EN 60309 part 2 includes only 16 A and 32 A low-voltage plug-type devices. In practice, the demand for devices with higher rated currents is constantly increasing. For this requirement, we have produced the 63 A low-voltage device range for the various voltages and frequencies (see table). In terms of form and safety engineering, these are manufactured according to CEE regulation.

The standard types are tested at the electro-technical testing agency in Munich, in accordance with DIN VDE 0623/3.77 sections 20, 21 and 22 contact rating - normal operation - temperature increase.

16	24	50 - 60	410		416	
	42	50 - 60	411	12	417	12
	≤50	100 - 200	412	4	418	4
	≤50	300	413	2	419	2
	≤50	-----	415	10		
32	24	50 - 60	4111		4117	
	42	50 - 60	4112	12	4118	12
	≤50	100 - 200	4113	4	4119	4
	≤50	300	4114	2	4120	2
	≤50	-----	4116	10		



Surface Mounting Socket Outlet

Splashproof
M25 Top Entry

16	24	50 - 60	420		426	
	42	50 - 60	421	12	427	12
	≤50	100 - 200	422	4	428	4
	≤50	300	423	2	429	2
	≤50	-----	425	10		
32	24	50 - 60	4211		4217	
	42	50 - 60	4212	12	4218	12
	≤50	100 - 200	4213	4	4219	4
	≤50	300	4214	2	4220	2
	≤50	-----	4216	10		



Panel Mounting Socket Outlet 20°Angle

Splashproof

Flange 68 x 62mm
Fixing centres
53 x 47mm

16	24	50 - 60	430		436	
	42	50 - 60	431	12	437	12
	≤50	100 - 200	432	4	438	4
	≤50	300	433	2	439	2
	≤50	-----	435	10		
32	24	50 - 60	4311		4317	
	42	50 - 60	4312	12	4318	12
	≤50	100 - 200	4313	4	4319	4
	≤50	300	4314	2	4320	2
	≤50	-----	4316	10		



Panel Mounting Socket Straight

Splashproof

Flange 55 x 55mm
Fixings 45 x 45mm

16	24	50 - 60	4354		4360	
	42	50 - 60	4355	12	4361	12
	≤50	100 - 200	4356	4	4362	4
	≤50	300	4357	2	4363	2
	≤50	-----	4359	10		
32	24	50 - 60	4365		4371	
	42	50 - 60	4366	12	4372	12
	≤50	100 - 200	4367	4	4373	4
	≤50	300	4368	2	4374	2
	≤50	-----	4370	10		



Panel Mounting Socket Straight

Splashproof

Flange 75 x 75mm
Fixings 60 x 60mm

Dimensions

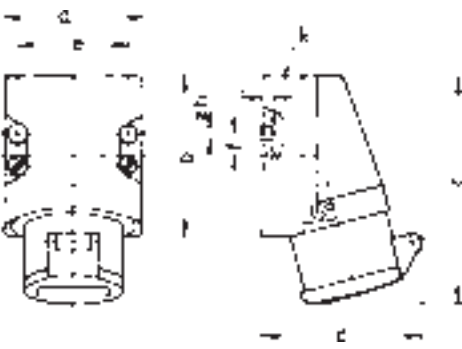

Amperes	16		32	
	2	3	2	3
Poles				
a	70	70	70	70
b	80	80	80	80
c	113	113	113	113
d	80	80	80	80
e	55	55	55	55
f	11	11	11	11
Ø h	5.2	5.2	5.2	5.2
i	5	5	5	5
k	M25	M25	M25	M25
Conductor mm ² min	4	4	4	4
Conductor mm ² max	10	10	10	10

Surface Mounting Socket Outlet

 Splashproof
M25 Top Entry

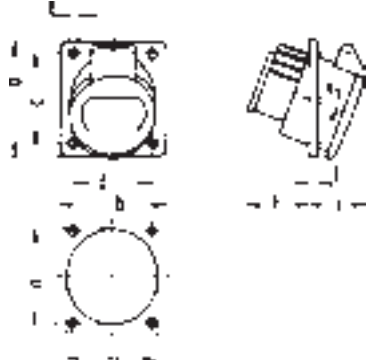

Amperes	16		32	
	2	3	2	3
Poles				
a	68	68	68	68
b	62	62	62	62
c	53	53	53	53
d	47	47	47	47
Ø e	5.2	5.2	5.2	5.2
f	6	6	6	6
h	36	36	36	36
i	35	35	35	35
x	20°	20°	20°	20°
n	56	56	56	56
m	52	52	52	52
Conductor mm ² min	4	4	4	4
Conductor mm ² max	10	10	10	10

Panel Mounting Socket Outlet 20° Angle

 Splashproof
Flange 68 x 62mm
Fixing centres
53 x 47mm

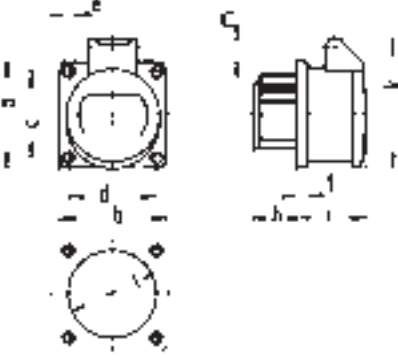

Amperes	16		32	
	2	3	2	3
Poles				
a	55	55	55	55
b	55	55	55	55
c	45	45	45	45
d	45	45	45	45
Ø e	5.2	5.2	5.2	5.2
f	6	6	6	6
h	22	22	22	22
i	37	37	37	37
k	67	67	67	67
l	49	49	49	49
m	12	12	12	12
Conductor mm ² min	4	4	4	4
Conductor mm ² max	10	10	10	10

Panel Mounting Socket Straight

 Splashproof
Flange 55 x 55mm
Fixings 45 x 45mm

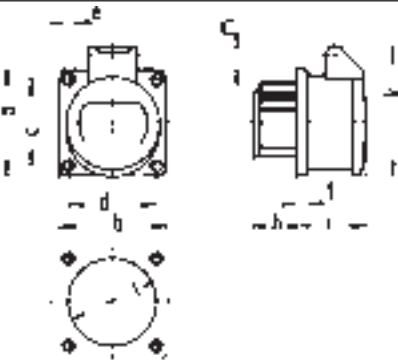

Amperes	16		32	
	2	3	2	3
Poles				
a	75	75	75	75
b	75	75	75	75
c	60	60	60	60
d	60	60	60	60
Ø e	5.2	5.2	5.2	5.2
f	6	6	6	6
h	22	22	22	22
i	37	37	37	37
k	67	67	67	67
l	49	49	49	49
m	2	2	2	22
Conductor mm ² min	4	4	4	4
Conductor mm ² max	10	10	10	10

Panel Mounting Socket Straight

 Splashproof
Flange 75 x 75mm
Fixings 60 x 60mm

16	24	50 - 60	460		466	
	42	50 - 60	461	12	467	12
	≤50	100 - 200	462	4	468	4
	≤50	300	463	2	469	2
	≤50	-----	465	10		
32	24	50 - 60	4611		4617	
	42	50 - 60	4612	12	4618	12
	≤50	100 - 200	4613	4	4619	4
	≤50	300	4614	2	4620	2
	≤50	-----	4616	10		



Surface Mounting Appliance Inlet
 Splashproof
M25 Top Entry

16	24	50 - 60	440		446	
	42	50 - 60	441	12	447	12
	≤50	100 - 200	442	4	448	4
	≤50	300	443	2	449	2
	≤50	-----	445	10		
32	24	50 - 60	4411		4417	
	42	50 - 60	4412	12	4418	12
	≤50	100 - 200	4413	4	4419	4
	≤50	300	4414	2	4420	2
	≤50	-----	4416	10		



Plug with Cable Sleeve
 Splashproof

16	24	50 - 60	450		456	
	42	50 - 60	451	12	457	12
	≤50	100 - 200	452	4	458	4
	≤50	300	453	2	459	2
	≤50	-----	455	10		
32	24	50 - 60	4511		4517	
	42	50 - 60	4512	12	4518	12
	≤50	100 - 200	4513	4	4519	4
	≤50	300	4514	2	4520	2
	≤50	-----	4516	10		



Connector with Cable Sleeve
 Splashproof

16	24	50 - 60	4422		4428	
	42	50 - 60	4423	12	4429	12
	≤50	100 - 200	4424	4	4430	4
	≤50	300	4425	2	4431	2
	≤50	-----	4427	10		
32	24	50 - 60	4433		4439	
	42	50 - 60	4434	12	4440	12
	≤50	100 - 200	4435	4	4441	4
	≤50	300	4436	2	4442	2
	≤50	-----	4438	10		



Plug with Cable Gland
 Splashproof

16	24	50 - 60	4522		4528	
	42	50 - 60	4523	12	4529	12
	≤50	100 - 200	4524	4	4530	4
	≤50	300	4525	2	4531	2
	≤50	-----	4527	10		
32	24	50 - 60	4533		4539	
	42	50 - 60	4534	12	4540	12
	≤50	100 - 200	4535	4	4541	4
	≤50	300	4536	2	4542	2
	≤50	-----	4538	10		



Connector with Cable Gland
 Splashproof

Dimensions

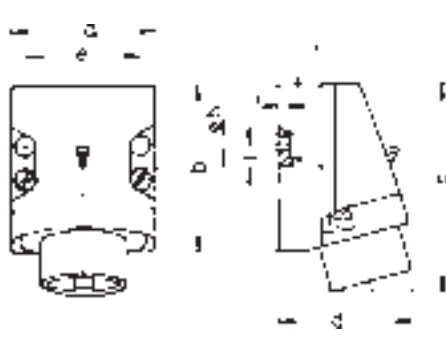

Amperes	16		32	
	2	3	2	3
Poles				
a	70	70	70	70
b	80	80	80	80
c	100	100	100	100
d	82	82	82	82
e	55	55	55	55
f	11	11	11	11
Ø h	5.2	5.2	5.2	5.2
i	5	5	5	5
k	M25	M25	M25	M25
Conductor mm ² min	4	4	4	4
Conductor mm ² max	10	10	10	10

Surface Mounting Appliance Inlet

 Splashproof
M25 Top Entry

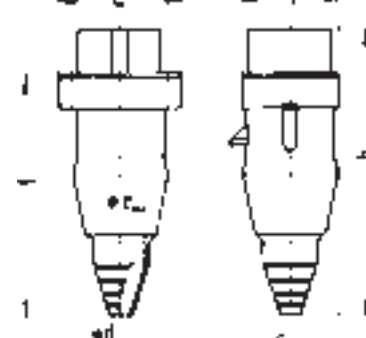

Amperes	16		32	
	2	3	2	3
Poles				
a	62	62	62	62
b	145	145	145	145
c	55	55	55	55
Ø d	7	7	7	7
Ø e	24.5	24.5	24.5	24.5
f	123	123	123	123
i	50	50	50	50
Conductor mm ² min	4	4	4	4
Conductor mm ² max	10	10	10	10

Plug with Cable Sleeve

 Splashproof

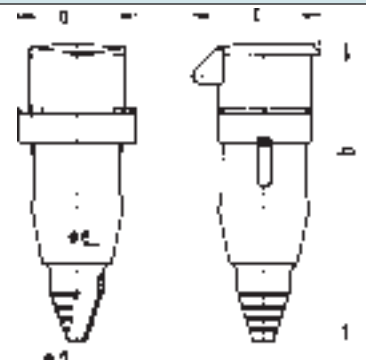

Amperes	16		32	
	2	3	2	3
Poles				
a	62	62	62	62
b	158	158	158	158
c	67	67	67	67
Ø d	7	7	7	7
Ø e	24.5	24.5	24.5	24.5
Conductor mm ² min	4	4	4	4
Conductor mm ² max	10	10	10	10

Connector with Cable Sleeve

 Splashproof

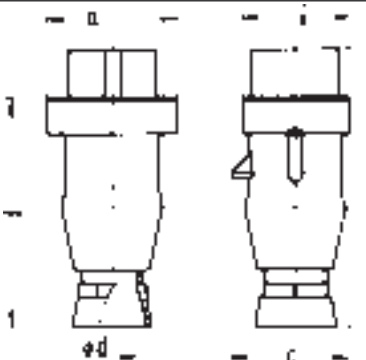

Amperes	16		32	
	2	3	2	3
Poles				
a	62	62	62	62
b	129	129	129	129
c	55	55	55	55
Ø d	24.5	24.5	24.5	24.5
f	107	107	107	107
i	50	50	50	50
Conductor mm ² min	4	4	4	4
Conductor mm ² max	10	10	10	10

Plug with Cable Gland

 Splashproof

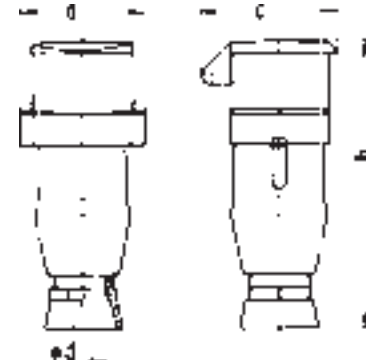

Amperes	16		32	
	2	3	2	3
Poles				
a	62	62	62	62
b	142	142	142	142
c	67	67	67	67
Ø d	24.5	24.5	24.5	24.5
Conductor mm ² min	4	4	4	4
Conductor mm ² max	10	10	10	10

Connector with Cable Gland

 Splashproof

Notes:

Refrigerated (Reefer) Container Plugs and Sockets



Chemical and
Heavy Industry



Harbour
installation containers,
ship yards and
shipping lines

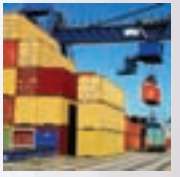

Mining and
tunnelling

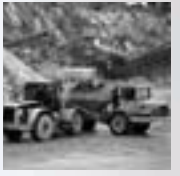

Camping and
caravanning



Building and
construction
industry

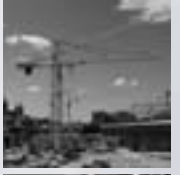

Food processing
and packaging



Agriculture
and farming

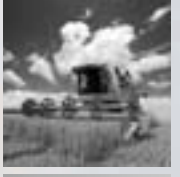

Military
applications

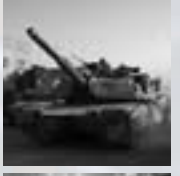

Industrial
and commercial
properties



Power generation
and distribution



Oil and gas
(non hazardous
areas)

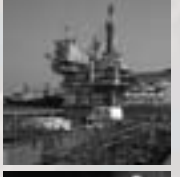

Film, TV and
outdoor events

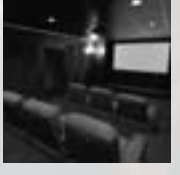

Refrigerated (Reefer) Container Plugs and Sockets



- All seals are resistant to deformation even under high pressure loading (good rebound resilience)
- No internal strain relief any longer, as this is integrated in the Multi-Grip cable gland



- Bayonet system in conjunction with sealing cap offers additional protection against saline sea air and the penetration of sea water



- Easy to view status of RCD and / or MCB through transparent flip-open windows
- RCD and / or MCB's are easy to operate, by simply opening and closing the flip-open window
- Switch can be triplelocked in 0 position with a padlock

- All the materials used are particularly resistant to sea water

- Special combination in special steel housing for a refrigerated container ship of a leading shipping line



Safe, Robust, Easy to Install

The certificates from international testing authorities confirm the high quality standard of the plug-type devices

Lloyd's Register, Bureau Veritas and others approved.



CEE Norm U.K. Reefer Container Equipment is used at seaports and container terminals all over the world and on many ships.

Multi-socket outlet units are available on a 'Made to Order' basis. Please enquire for further details.

A CURRENT	V VOLTAGE	Hz FREQUENCY	 3P+E	EARTH HR. POS.
---------------------	---------------------	------------------------	---	----------------------

Container Plugs & Sockets

CEE NORM

32 	440	50 - 60	11556	3
---	------------	---------	--------------	---



Surface Mounting Socket Outlet

 Watertight
Nickel plated contacts

32 	440	50 - 60	13021	3
---	------------	---------	--------------	---



Panel Mounting Socket Outlet

 Watertight
Nickel plated contacts
Flange 75 x 75mm
Fixing centres: 60 x 60mm

32 	440	50 - 60	21485	3
---	------------	---------	--------------	---



Plug with Multi-Grip Cable Gland

- Multi-Grip cable gland system with moulded-in gasket

 Watertight
Nickel plated contacts

32 	440	50 - 60	31423	3
---	------------	---------	--------------	---



Connector with Multi-Grip Cable Gland

- Multi-Grip cable gland system with moulded-in gasket

 Watertight
Nickel plated contacts

32 	440	50 - 60	27027	3
---	------------	---------	--------------	---



Panel Mounting Appliance Inlet

 Watertight
Nickel plated contacts
Flange 85 x 85mm
Fixing centres: 70 x 70mm

32 	440	50 - 60	16050	3
---	------------	---------	--------------	---



Socket Outlet

Switched with mechanical double interlocking
 Watertight
Nickel plated contacts

32 	440	50 - 60	17026	3
---	------------	---------	--------------	---



Socket Outlet

Switched with mechanical double interlocking
 Watertight
Nickel plated contacts
To accept RCD/MCB

Also available with RCD fitted / pre-wired **880160**
or with RCD+MCB **880161**.

Dimensions

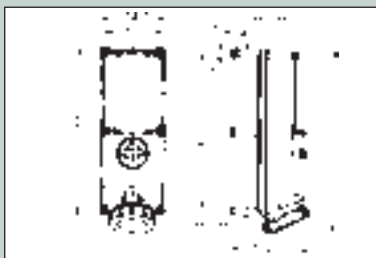
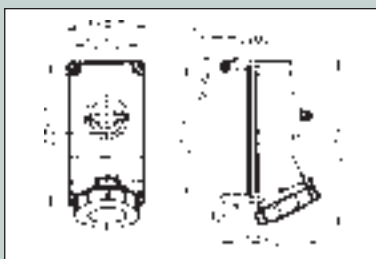
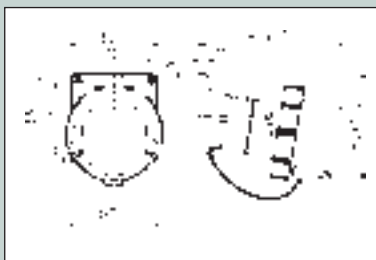
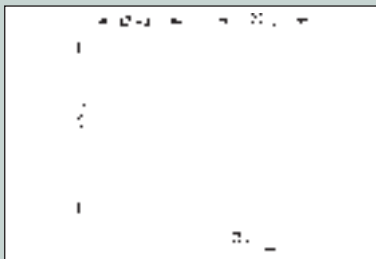
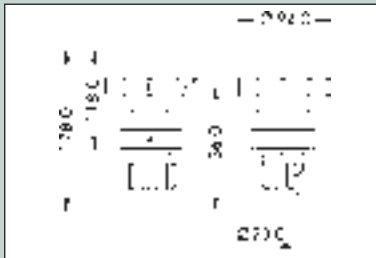
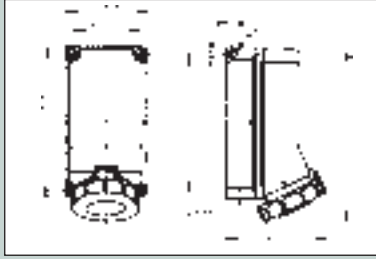

Notes:

Special Purpose Products



500V & High Frequency

DC Current

7 Pole

page 92

page 93

page 94

Chemical and Heavy Industry



Harbour installation containers, ship yards and shipping lines



Mining and tunnelling

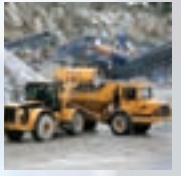

Camping and caravanning

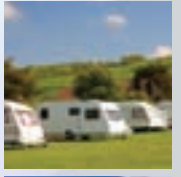

Building and construction industry

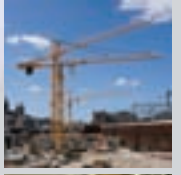

Food processing and packaging

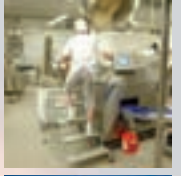

Agriculture and farming

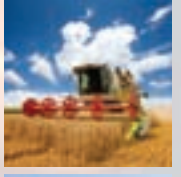

Military applications

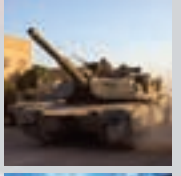

Industrial and commercial properties



Power generation and distribution



Oil and gas (non hazardous areas)

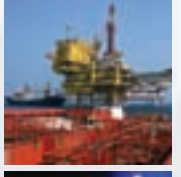

Film, TV and outdoor events

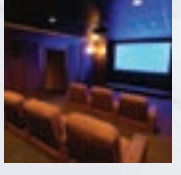

Special Purpose Products



TK-Kombi

- Compact combination of CEE and SCHUKO socket
- Fuse protection of the shockproof socket possible
- Provision with shockproof sockets 16 / 230V in Belgian/French, Danish and Swiss norms also possible



DC plug-type devices

- For testing shops, electroplating plants, rail vehicles and maintenance areas



Phase sequence indicator tri-pole

- CEE plug with integrated shockproof socket and built-in electronics enables monitoring of the rotary field, as well as recognition in the event of failure of a phase.
- Via the shockproof socket, further test devices can be connected, and amongst other things a function test of FI switches can be carried out.



ACS mounted socket

- Auxiliary contact switch with diverse applications: checking, controlling, regulating, monitoring
- Additional auxiliary contact switch on mounted sockets (shockproof 16/32A CEE socket) closes and / or opens through plug
- Electrical plug locking possible
- Potential-free switching
- Switching element, e.g. contactor, can be set separately

Safe, Robust, Easy to Install



Conventional Locking

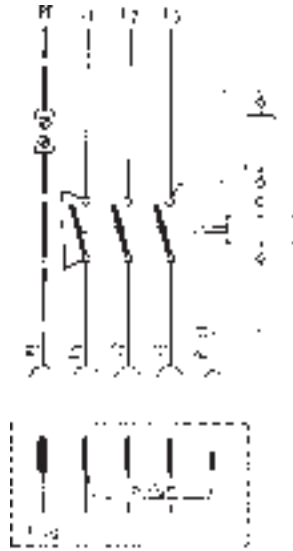

PSC Locking

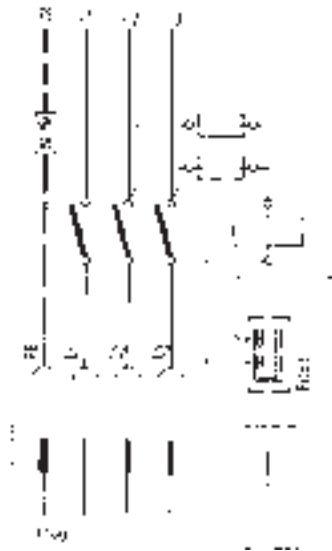

PSC - Pilot-Switch Contact

- Potential-free switching of the built-in auxiliary contact in pilot drilled hole of the socket (63 A and 125 A).
- Suitable for contactor locking or for additional control purposes.
- As all sockets are subjected to contact rating testing, they are supplied without pilot contact or PSC contact; if a pilot contact is required, a P is added to the order number.



7-pole plug type devices

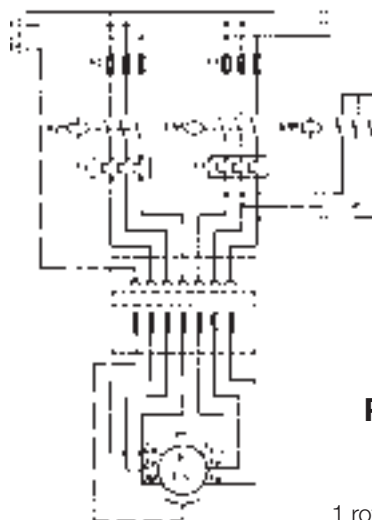

- Clear advantages in the areas of pole-changing / star-delta connection, traffic light switching / regulation / electrical locking / monitoring / acknowledgement / notification

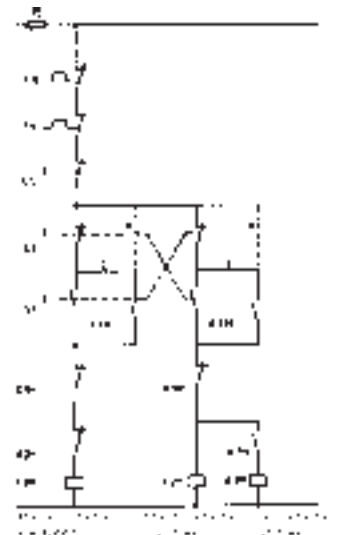

Pole changing

With RC motors
Dahlander circuit,
1 rotary direction, 2 speeds





16 	500	50 - 60			116	7		
	>50	100 - 300			117	10		
	>50	301 - 500			118	2		
32 	500	50 - 60			1119	7		
	>50	100 - 300			1120	10		
	>50	301 - 500			1121	2		
63 	500	50 - 60			1128	7		



Surface Mounting Socket Outlet

 Splashproof



16 	500	50 - 60			1222	7		
	>50	100 - 300			1223	10		
	>50	301 - 500			1224	2		
32 	500	50 - 60			1234	7		
	>50	100 - 300			1235	10		
	>50	301 - 500			1236	2		
63 	500	50 - 60			1204	7		



Panel Mounting Socket Outlet

 Splashproof

Angled



16 	500	50 - 60			1325	7		
	>50	100 - 300			1326	10		
	>50	301 - 500			1327	2		
32 	500	50 - 60			13012	7		
	>50	100 - 300			13013	10		
	>50	301 - 500			13014	2		
63 	500	50 - 60			1301	7		



Panel Mounting Socket Outlet

 Splashproof



Straight

16 	500	50 - 60			2410	7		
	>50	100 - 300			2411	10		
	>50	301 - 500			2412	2		
32 	500	50 - 60			24173	7		
	>50	100 - 300			24174	10		
	>50	301 - 500			24175	2		
63 	500	50 - 60			24183	7		



Surface Mounting Appliance Inlet

 Splashproof



16 	500	50 - 60			2131	7		
	>50	100 - 300			2132	10		
	>50	301 - 500			2133	2		
32 	500	50 - 60			2143	7		
	>50	100 - 300			2144	10		
	>50	301 - 500			2145	2		
63 	500	50 - 60			2152	7		



QUICK CONNECT[®] Plug with Multi-Grip Cable Gland

- Screwless terminals
- 4-point (quarter turn) locking system
- Multi-Grip cable gland system with moulded-in gasket

 Splashproof

16 	500	50 - 60			3131	7		
	>50	100 - 300			3132	10		
	>50	301 - 500			3133	2		
32 	500	50 - 60			3143	7		
	>50	100 - 300			3144	10		
	>50	301 - 500			3145	2		
63 	500	50 - 60			3152	7		



QUICK CONNECT[®] Conector with Multi-Grip Cable Gland

- Screwless terminals
- 4-point (quarter turn) locking system
- Multi-Grip cable gland system with moulded-in gasket

 Splashproof

63A with screw / clamp terminals and pilot contact

Note: This pilot contact should **NOT** be counted as a main 'pin'

QUICK CONNECT[®]

A CURRENT	V VOLTAGE	Hz FREQUENCY	2P+E	EARTH HR. POS.
--------------	--------------	-----------------	------	----------------------

DC Plugs & Sockets

CEE NORM

16		> 50 - 250	-----	110074	3
32		> 50 - 250	-----	11275	3



Surface Mounting Socket Outlet

Splashproof

As above but

Watertight

16		> 50 - 250	-----	11042	3
32		> 50 - 250	-----	11127	3



Panel Mounting Socket Outlet Angled

Splashproof

16		> 50 - 250	-----	12144	3
32		> 50 - 250	-----	12174	3

16*		> 50 - 250	-----	13062	3
16†		> 50 - 250	-----	13070	3
32		> 50 - 250	-----	13063	3



Panel Mounting Socket Outlet

Splashproof

As above but

Watertight

16		> 50 - 250	-----	13209	3
32		> 50 - 250	-----	13174	3

16		> 50 - 250	-----	21868	3
32		> 50 - 250	-----	21869	3



Plug

Splashproof

As above but

Watertight

16		> 50 - 250	-----	21562	3
32		> 50 - 250	-----	21817	3

16		> 50 - 250	-----	31677	3
32		> 50 - 250	-----	31678	3



Connector

Splashproof

As above but

Watertight

16		> 50 - 250	-----	31695	3
32		> 50 - 250	-----	31647	3



Switched Interlock Socket

Switched with mechanical double interlock

Splashproof

16		> 50 - 250	-----	16449	3
32		> 50 - 250	-----	16450	3

A CURRENT	V VOLTAGE	Hz FREQUENCY	 6P+E	EARTH HR. POS.
---------------------	---------------------	------------------------	---	-------------------------------

7 Pole Plugs & Sockets

CEE NORM

16	240	50 - 60	11480	9
32	240	50 - 60	11482	9
16	415	50 - 60	11481	6
32	415	50 - 60	11483	6



Surface Mounting Socket Outlet

 Splashproof

16	240	50 - 60	13326	9
32	240	50 - 60	13328	9
16	415	50 - 60	13327	6
32	415	50 - 60	13329	6



Panel Mounting Socket Outlet

 Splashproof

16	240	50 - 60	210550	9
32	240	50 - 60	210636	9
16	415	50 - 60	21557	6
32	415	50 - 60	210067	6



Plug TE-Plus with Multi-Grip Cable Gland

- Multi-Grip cable gland system with moulded-in gasket

 Splashproof

16	240	50 - 60	310311	9
32	240	50 - 60	310381	9
16	415	50 - 60	31752	6
32	415	50 - 60	310123	6



Connector with Multi-Grip Cable Gland

- Multi-Grip cable gland system with moulded-in gasket

 Splashproof

16	240	50 - 60	24193	9
32	240	50 - 60	24195	9
16	415	50 - 60	24194	6
32	415	50 - 60	24196	6



Surface Mounting Appliance Inlet

 Splashproof

16	240	50 - 60	16445	9
32	240	50 - 60	16446	9
16	415	50 - 60	16378	6
32	415	50 - 60	160438	6



Surface Mounting Switched Interlocked Socket Outlet

 Splashproof

16	240	50 - 60	21481	9
32	240	50 - 60	21483	9
16	415	50 - 60	21480	6
32	415	50 - 60	21482	6



Special Plugs for Earth Monitoring 6 Pin (with 2 Shortened Pins) + E

 Splashproof

Dimensions

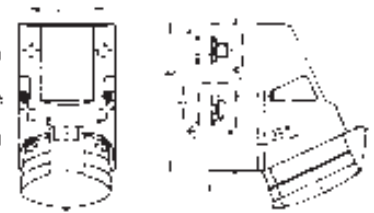

Amperes	16	32
Poles	7	7
a	83	83
b	126	126
c	155	155
d	130	136
e	68	68
f	11	11
Ø h	5.5	5.5
i	6.5	6.5
Ø k	12	12
l	65	65
m	80	80
Ø n	10	10
o	M25	M25
p	2x M25	2x M25
Conductor mm ² min	1.5	2.5
Conductor mm ² max	4	10

Surface Mounting Socket Outlet

 Splashproof



Amperes	16	32
Poles	7	7
a	75	75
b	75	75
c	60	60
d	60	60
Ø e	5.5	5.5
f	7	8
h	35.5	50
i	53	62
k	85	98
Ø l	55	60
m	11.5	17
Conductor mm ² min	1.5	2.5
Conductor mm ² max	4	10

Panel Mounting Socket Outlet

 Splashproof



Amperes	16	32
Poles	7	7
Ø a	65	72
b	97	117
c	152	181
d	116	135.5
Ø e	21	27
Conductor mm ² min	1	2.5
Conductor mm ² max	2.5	6

Plug TE-Plus with Multi-Grip Cable Gland

- Multi-Grip cable gland system with moulded-in gasket

 Splashproof



Amperes	16	32
Poles	7	7
Ø a	65	72
b	168	198
c	86	99
Ø d	21	27
Conductor mm ² min	1	2.5
Conductor mm ² max	2.5	6

Connector with Multi-Grip Cable Gland

- Multi-Grip cable gland system with moulded-in gasket

 Splashproof



Amperes	16	32
Poles	7	7
a	83	83
b	126	126
c	155.5	166
d	122	130
e	68	68
f	11	11
Ø h	5.5	5.5
i	6.5	6.5
Ø k	12	12
l	65	65
m	80	80
Ø n	10	10
p	M25	M25
r	2x M25	2x M25
Conductor mm ² min	1	2.5
Conductor mm ² max	2.5	6

Surface Mounting Appliance Inlet

 Splashproof

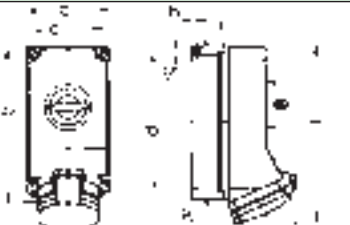

Amperes	16	32
Poles	7	7
a	118	160
b	225	260
c	101	140
d	208	240
e	134	184
f	242	302
Ø g	6.5	8.1
h	8	10
i	2x M25	1x M40
k	2x M25	1x M32/M40

Surface Mounting Switched Interlocked Socket Outlet

 Splashproof



Amperes	16	32
Poles	7	7
Ø a	65	72
b	97	117
c	152	181
d	116	135.5
Ø e	21	27
Conductor mm ² min	1	2.5
Conductor mm ² max	2.5	6

Special Plugs for Earth Monitoring 6 Pin (with 2 Shortened Pins) + E

 Splashproof

A CURRENT	V VOLTAGE	Hz FREQUENCY	 6P+E	EARTH HR. POS.
---------------------	---------------------	------------------------	---	-----------------------

7 Pole Plugs & Sockets

CEE NORM

16	240	50 - 60	11634	9
32	240	50 - 60	11635	9
16	415	50 - 60	11542	6
32	415	50 - 60	11578	6



Surface Mounting Socket Outlet

 Watertight

16	240	50 - 60	13330	9
32	240	50 - 60	13332	9
16	415	50 - 60	13331	6
32	415	50 - 60	13333	6



Panel Mounting Socket Outlet

 Watertight

16	240	50 - 60	21711	9
32	240	50 - 60	21712	9
16	415	50 - 60	21667	6
32	415	50 - 60	21669	6



Plug with Multi-Grip Cable Gland

- Multi-Grip cable gland system with moulded-in gasket

 Watertight

16	240	50 - 60	31512	9
32	240	50 - 60	31514	9
16	415	50 - 60	31513	6
32	415	50 - 60	31515	6



Connector with Multi-Grip Cable Gland

- Multi-Grip cable gland system with moulded-in gasket

 Watertight

16	240	50 - 60		9
32	240	50 - 60		9
16	415	50 - 60	24309	6
32	415	50 - 60	24536	6



Surface Mounting Appliance Inlet

 Watertight

16	240	50 - 60	16447	9
32	240	50 - 60	16448	9
16	415	50 - 60	16380	6
32	415	50 - 60	160087	6



Surface Mounting Switched Interlocked Socket Outlet

 Watertight

16	240	50 - 60	21823	9
32	240	50 - 60	21811	9
16	415	50 - 60	21818	6
32	415	50 - 60	21600	6



Special Plugs for Earth Monitoring 6 Pin (with 2 Shortened Pins) + E

 Watertight

Dimensions



Amperes	16	32
Poles	7	7
a	90	118
b	170	225
c	77	101
d	137.5	1208
e	122	149
f	195	255
g	6.5	6.5
Ø h	5.5	8
i	M20	2x M25
k	M20 / 25	2x M25
Conductor mm ² min	1.5	2.5
Conductor mm ² max	4	10

Surface Mounting Socket Outlet

 Watertight



Amperes	16	32
Poles	7	7
a	75	75
b	75	75
c	60	60
d	60	60
Ø e	5.5	5.5
f	7	8
h	35.5	50
i	57	65
k	93	106
Ø l	55	60
m	11.5	17
Conductor mm ² min	1.5	2.5
Conductor mm ² max	4	10

Panel Mounting Socket Outlet

 Watertight



Amperes	16	32
Poles	7	7
Ø a	86	101
b	97	117
c	152	181
d	119	138.5
Ø e	21	27
Conductor mm ² min	1	2.5
Conductor mm ² max	2.5	6

Plug with Multi-Grip Cable Gland

- Multi-Grip cable gland system with moulded-in gasket

 Watertight



Amperes	16	32
Poles	7	7
Ø a	86.5	101.5
b	168	200
c	93	107
Ø d	21	27
Conductor mm ² min	1	2.5
Conductor mm ² max	2.5	6

Connector with Multi-Grip Cable Gland

- Multi-Grip cable gland system with moulded-in gasket

 Watertight

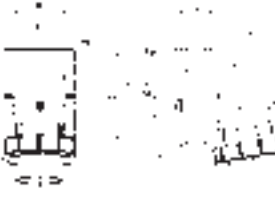

Amperes	16	32
Poles	7	7
a	84	90
b	84	75
c	136	139
d		123
ef		
Ø h		
i		
k		
l	111	
m	64	78
n	64	45
Ø o	5.5	5.5
p		
r	M20	M25
Ø s	23	29
t		

Surface Mounting Appliance Inlet

 Watertight



Amperes	16	32
Poles	7	7
a	118	160
b	225	260
c	101	140
d	208	240
e	134	195
f	245	304
Ø g	6.5	8.1
h	8	10
i	2x M25	1x M40
k	2x M25	1x M32/M40

Surface Mounting Switched Interlocked Socket Outlet

 Watertight

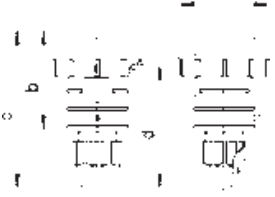

Amperes	16	32
Poles	7	7
Ø a	86	101
b	97	117
c	152	181
d	119	138.5
Ø e	21	27
Conductor mm ² min	1	2.5
Conductor mm ² max	2.5	6

Special Plugs for Earth Monitoring 6 Pin (with 2 Shortened Pins) + E

 Watertight

Notes:

Chemical and Heavy Industry



Harbour installation containers, ship yards and shipping lines



Mining and tunnelling

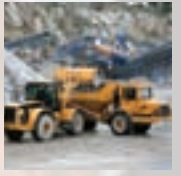

Camping and caravanning



Building and construction industry

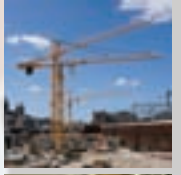

Food processing and packaging

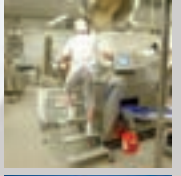

Agriculture and farming

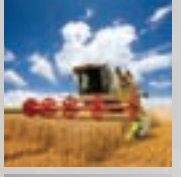

Military applications

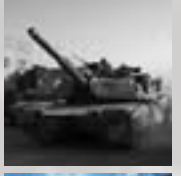

Industrial and commercial properties



Power generation and distribution



Oil and gas (non hazardous areas)

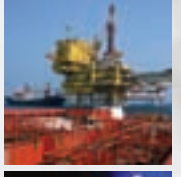

Film, TV and outdoor events

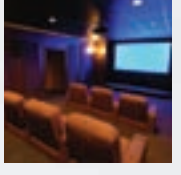

Phase Inverters



Phase Inverters



- Offers an ingenious solution to change the direction of AC electric motor rotation
- Change of rotary field is possible using a simple screwdriver
- Available in IP44 or IP67



- Unique cable gland system with moulded-in gasket
- Adapts easily to all common cable types and diameters
- Cable is securely fastened and tight
- Inspection of cable gland system from the outside without the need of opening the plug





Safe, Robust, Easy to Install



- Phase inverter in 16A and 32A 5-pole design
- Wide range for the most diverse application conditions
- IP44 splashproof design
- IP67 watertight design
- All pins brass-nickel-plated





- Additional water protection through separate sealing cap
- See page 52 for details

A CURRENT	V VOLTAGE	Hz FREQUENCY			 3P+E	EARTH HR. POS	 3P+N+E	EARTH HR. POS
---------------------	---------------------	------------------------	--	--	---	---------------------	---	---------------------

Phase Inverters

CEE NORM

16 	240 415	50 - 60				22052	9	
						22053	6	
32 	240 415	50 - 60				22054	9	
						22055	6	

QUICK CONNECT®



The range of QUICK-CONNECT products are shown on pages 61 - 73



QUICK CONNECT® Phase Inverter Plug with Multi-Grip Cable Gland

- Screwless terminals
- 4-point (quarter turn) locking system
- Multi-Grip cable gland system with moulded-in gasket

 Splashproof

16 	240 415	50 - 60				224	9	
						225	6	
32 	240 415	50 - 60				226	9	
						227	6	

QUICK CONNECT®



The range of QUICK-CONNECT products are shown on pages 61 - 73



QUICK CONNECT® Phase Inverter Plug with Multi-Grip Cable Gland

- Screwless terminals
- 4-point (quarter turn) locking system
- Multi-Grip cable gland system with moulded-in gasket



 Splashproof

16 	240 415	50 - 60				2266	9	
						2251	6	
32 	240 415	50 - 60				2267	9	
						2252	6	



Phase Inverter Plug with Multi-Grip Cable Gland

 Watertight

16 	240 415	50 - 60				24208	9	
						24209	6	
32 	240 415	50 - 60				24210	9	
						24211	6	



Phase Inverter Surface Mounting Appliance inlet

 Splashproof



The phase-inverter offers an ingenious solution to change the direction of rotation of three phase alternating current motors.

Two phase pins are mounted on a turntable plate, which can be unlocked and turned through 180° left or right using a simple screwdriver. Only one movement is necessary to turn the motor direction without changing the cable connections.

Dimensions

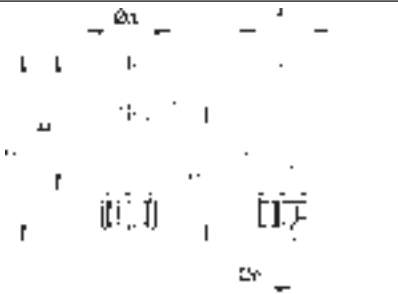

Amperes	16		32	
	4	5	4	5
Poles				
Ø a	60	66	74.5	74.5
b	100.5	103	121	121.5
c	141	142	174	174.5
d	104.5	105.5	128	128.5
Ø e	18	18	23	23
f	64.5	70.5	78	80
Conductor mm ² min	1	1	2.5	2.5
Conductor mm ² max	2.5	2.5	6	6

QUICK CONNECT[®] Phase Inverter Plug with Multi-Grip Cable Gland

- Screwless terminals
- 4-point (quarter turn) locking system
- Multi-Grip cable gland system with moulded-in gasket

 Splashproof

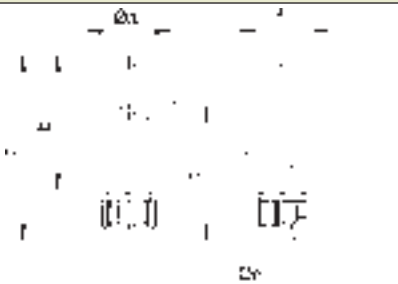

Amperes	16		32	
	4	5	4	5
Poles				
Ø a	60	66	74.5	74.5
b	100.5	103	121	121.5
c	141	142	174	174.5
d	104.5	105.5	128	128.5
Ø e	18	18	23	23
f	64.5	70.5	78	80
Conductor mm ² min	1	1	2.5	2.5
Conductor mm ² max	2.5	2.5	6	6

QUICK CONNECT[®] Phase Inverter Plug with Multi-Grip Cable Gland

- Screwless terminals
- 4-point (quarter turn) locking system
- Multi-Grip cable gland system with moulded-in gasket

 Splashproof

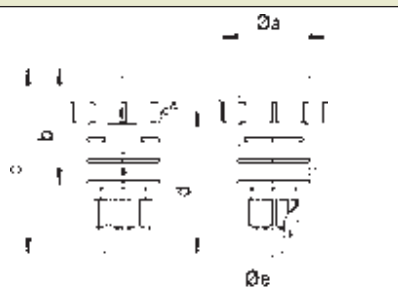

Amperes	16	32
	Poles	5
Ø a	86	101
b	97	117
c	152	181
d	119	138.5
Ø e	21	27
Conductor mm ² min	1	2.5
Conductor mm ² max	2.5	6

Phase Inverter Plug with Multi-Grip Cable Gland

 Watertight

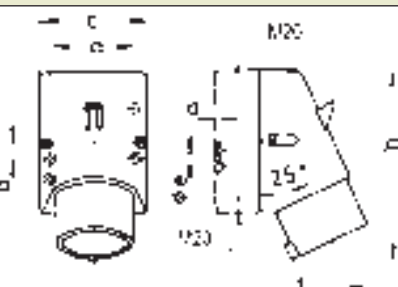

Amperes	16
	Poles
a	59
b	11
c	75
d	4
Ø e	5.1
f	110
h	135
i	100
k	-
Conductor mm ² min	1
Conductor mm ² max	2.5

Surface Mounting Appliance Inlet

 Splashproof



Amperes	32
	Poles
a	83
b	126
c	166
d	130
e	68
f	11
Ø h	5.5
i	6.5
Ø k	12
l	65
m	80
Ø n	10
p	M25
r	2x M25
Conductor mm ² min	2.5
Conductor mm ² max	6

Surface Mounting Appliance Inlet

 Splashproof

Notes:

Schuko



Chemical and Heavy Industry



Harbour installation containers, ship yards and shipping lines



Mining and tunnelling

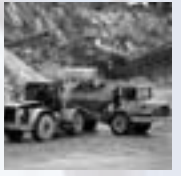

Camping and caravanning

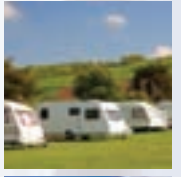

Building and construction industry

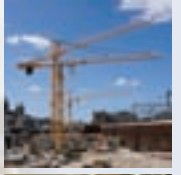

Food processing and packaging

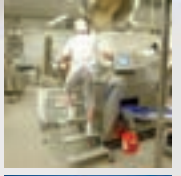

Agriculture and farming

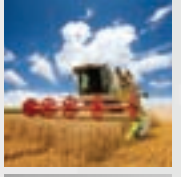

Military applications

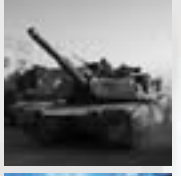

Industrial and commercial properties



Power generation and distribution



Oil and gas (non hazardous areas)

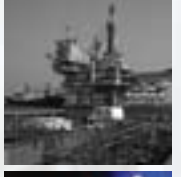

Film, TV and outdoor events

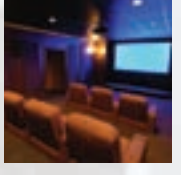

Schuko Plugs and Sockets



- Ergonomic shape ensures a good grip and simple handling



- Optionally available with cap on tab or flip-cap as special order



- Good connection facility through halfshell design
- All screws with combination head
- All screws can be operated from one direction
- Supplied with contacts open

Schuko equipment conforms to VDE 0620 European Standards



- IP44 (or IP67 to order)



- Variable connection options (rear and side)



- SCHUKO connector plug-type devices also available in Belgian / French system

Safe, Robust, Easy to Install

Schuko Plugs and Sockets

CEE NORM

The SCHUKO system available at 16A 230-250V is widely used on the European continent both in industrial and domestic areas. There are however two versions available, the more common German system and also the Belgian-French system.

The main characteristics are that the German system has 2 pins and scraping earth contacts on the plug and 2 receptacle holes and scraping earth contacts on the socket.

Whereas the Belgian-French system has 2 pins and 1 receptacle earth hole on the plug, 2 receptacle holes and 1 pin on the socket.

*Within our range we offer a plug with dual facilities which will safely operate with both types of socket.

The below items are based on the German system unless specified

A CURRENT	V VOLTAGE	Colour	Part No.	
16	250	Blue	7130	Panel socket with lid
	250	Grey	7132	Panel socket with lid
	250	Black	7134	Panel socket with lid
16	250	Blue	7139	Panel socket with lid Belgian - French System

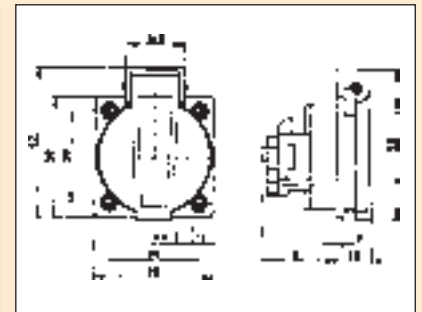

16	250	Blue	713	Panel socket without lid
	250	Grey	712	Panel socket without lid
	250	Black	714	Panel socket without lid

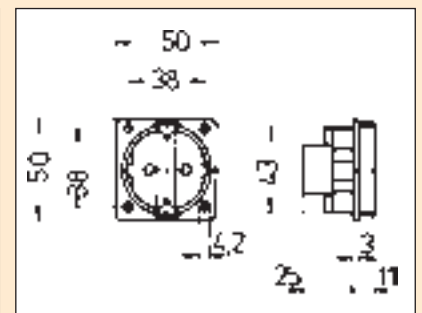
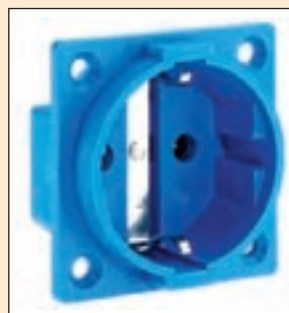

16	250	Blue	7302	Plug (plastic) dual system
	250	Grey	7303	Plug (plastic) dual system

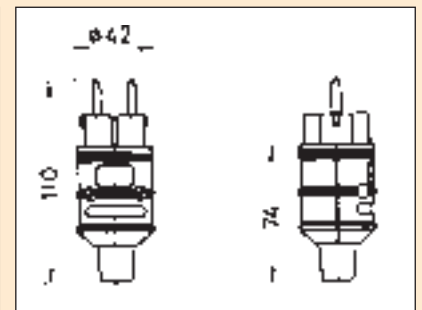

16	250	Blue	7409	Connector (plastic)
	250	Grey	7410	Connector (plastic)
	250	Blue	7415	Connector Belgian - French

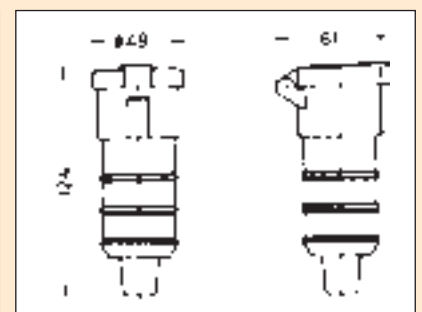

16	250	Black	7312	Plug (butyl rubber) dual system
	250	Black	740	Connector (butyl rubber)

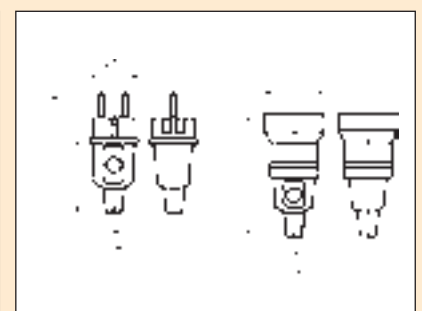

Combination Units

This section covers pre-wired combination units 16A - 125A unswitched or switch-interlocked with RCD and / or MCB protection.

Multi-outlet unswitched sockets with RCD and / or MCB protection.

Single and multi-outlet sockets without facility for integral protection.

Earth monitoring - continuity sensing socket outlets.

The applications for these products in industrial environments is endless, with CEE Norm U.K. Ltd already having supplied both standard and 'Made to Order' units to many household name companies.

Should you require any help finding the most suitable product for your application, please contact our sales office.

Combination Units



Pre-Wired (16, 32 & 63A)	Page 114
Multi-Outlet	Page 116
Switch-Interlocked (16, 32 & 63A)	Page 118
Pre-Wired (125A)	Page 120
Switch-Interlocked (125A)	Page 121
Single Socket Outlet	Page 122
Multi-Outlet Socket Units	Page 123
Heavy Duty Rubber In-Line	Page 125
Multi-Outlet Distribution Units	Page 126
Earth Monitoring Units	Page 127
Made To Order Units	Page 128

Chemical and Heavy Industry



Harbour installation containers, ship yards and shipping lines

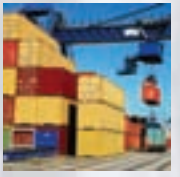

Mining and tunnelling

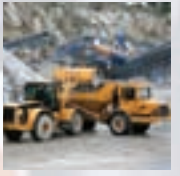

Camping and caravanning

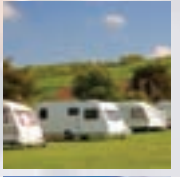

Building and construction industry

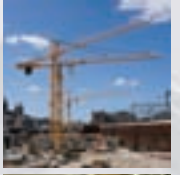

Food processing and packaging

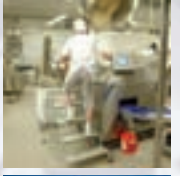

Agriculture and farming

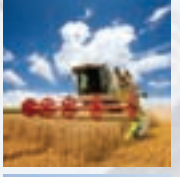

Military applications

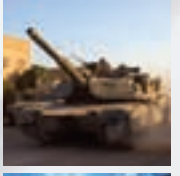

Industrial and commercial properties



Power generation and distribution



Oil and gas (non hazardous areas)

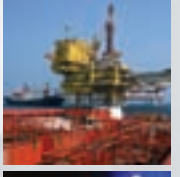

Film, TV and outdoor events

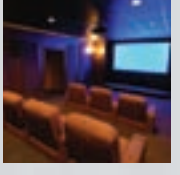

Combination Units

Custom built and bespoke electrical distribution boards designed and manufactured by CEE Norm U.K.

With over 40 years experience in the design of purpose built distribution boards, which can be manufactured in thermoplastic, rubber and steel fabrication, our equipment is installed in industries as diverse as:

- Camping and caravan parks as well as marina boat yards for leisure use
- Motor car manufacturing with major manufacturers throughout the UK and Europe
- International ship builders and repair yards providing welding repairs for offshore facilities
- Film, TV and outdoor events

Our RCD earth leakage and earth monitoring units are used in food processing, pharmaceutical industries and by all major utility companies and authorities for electricity, gas and water.

Established electrical contractors such as N.G. Bailey, B.K.I., Crown House, T. Clarke, Dodds Electrical, Wysepower and Aggreko all value the expertise of CEE Norm U.K. in the design of electrical distribution equipment.

CEE Norm U.K. plug and socket distribution systems have been used in the 2004 Athens Olympics, the Manchester Commonwealth Games and the Open Golf Championship. Wherever speed of installation is required, our products can be found giving both the distributor and end users confidence in both the supply and safety of the equipment being used.

Typical examples of the diverse range of equipment that can be supplied are indicated, together with the industry involved.

Please contact CEE Norm U.K. direct if you have specific requirements for purpose-designed distribution equipment.



Heavy duty steel bollard for street market / marina applications complete with RCD's / MCB's and socket outlets.

Free standing rubber distribution unit complete with input lead phase inverter (3 phase) and RCD / MCB protection.



Wall mounting rubber combination socket / distribution unit with 415V and 240V sockets plus RCD and MCB.

Hanging distribution unit 32A 3 phase complete with inlet plug and 3 sockets plus air line attachment.



Safe, Robust, Easy to Install



Accident, emergency and disaster control

Fully weatherproof free standing distribution unit in rubber complete with input lead available in 415V, 240V and 110V with RCD / MCB protection. For use by fire services and military applications.



Free standing rubber combination unit with incoming appliance inlets and cable storage. Multiple sockets can be provided in 415V / 240V supplies with RCD / RCBO / MCB protection.



Building and construction industry



Quarrying and minerals extraction

Wall mounting socket outlet combination units in fully weatherproof thermoplastic. Rated from 16A to 125A 400V complete with RCD and MCB protection and switched interlocked with padlockable switches.





Dual voltage hanging distribution units 415V / 240V in thermoplastic IP55.

Motor industry



Combined power and TV / satellite hook-up units.



Camping, caravanning and leisure industries

Full range of distribution units, complete with galvanised metal ground stakes are available from 1 way 16A 240V with RCD/MCB protection.

Metering facilities and multi-outlets up to 12 ways can also be manufactured.

Free standing distribution feeder pillars supplied in heavy duty powder coated paint or galvanised finishes.



Transport, storage, distribution and logistics

Food processing and packaging



Heavy duty rubber dual voltage 415V / 220V hanging distribution unit with 415V and 220V sockets and air line attachment.



Mining and tunnelling

Heavy duty rubber wall mounting distribution unit fitted with RCD / MCB's and 415V/220V sockets.



IP67 watertight thermoplastic wall mounting combination unit with RCD / MCB's and input terminals.

Chemical and heavy industry



Harbour installation containers, ship yards and shipping lines

Stainless steel IP67 rated lockable enclosure / distribution board with facility to lock door with plugs in situ. For use on 440V 3H 32A container / refrigerated supplies.



Unswitched RCD Protected Sockets

Unswitched internally **pre-wired** units are supplied with RCD
(for earth fault protection) with sensitivity of 30MA / 30MS as standard
(others available upon request)

16A Socket = 25A RCD

32A Socket = 40A RCD

63A Socket = 63A RCD

Sockets available at IP44 Splashproof or IP67 Watertight

3 Poles



240V 2P+E

One Socket Outlet IP44 Protected by 1x 30MA RCD			
16A	240	2P+E	880116
32A	240	2P+E	880120
63A	240	2P+E	880124
One Socket Outlet IP67 Protected by 1x 30MA RCD			
16A	240	2P+E	880516
32A	240	2P+E	880520
63A	240	2P+E	880524

3 Poles



110V 2P+E

One Socket Outlet IP44 Protected by 1x 30MA RCD			
16A	110	2P+E	880416
32A	110	2P+E	880420
63A	110	2P+E	880424
One Socket Outlet IP67 Protected by 1x 30MA RCD			
16A	110	2P+E	880560
32A	110	2P+E	880562
63A	110	2P+E	880565

4 Poles



415V 3P+E

One Socket Outlet IP44 Protected by 1x 30MA RCD			
16A	415	3P+E	880128
32A	415	3P+E	880132
63A	415	3P+E	880136
One Socket Outlet IP67 Protected by 1x 30MA RCD			
16A	415	3P+E	880528
32A	415	3P+E	880532
63A	415	3P+E	880536

5 Poles



415V 3P+N+E

One Socket Outlet IP44 Protected by 1x 30MA RCD			
16A	415	3P+N+E	880140
32A	415	3P+N+E	880144
63A	415	3P+N+E	880148
One Socket Outlet IP67 Protected by 1x 30MA RCD			
16A	415	3P+N+E	880540
32A	415	3P+N+E	880544
63A	415	3P+N+E	880548

Illustrations show IP44

	Amperes	16			32			63		
		3	4	5	3	4	5	3	4	5
a	163	222	222	222	222	222	222	222	222	222
b	280	284	284	284	284	284	284	370	370	370
c	142	204	204	204	204	204	204	top 168	168	168
c								btm 178	178	178
d	243	267	267	267	267	267	267	303	303	303
e	155	160	160	168	168	168	168	200	200	200
f	130	123	123	123	123	123	123	135	135	135
g	6	6	6	6	6	6	6	6	6	6

Units rated at 125A also available

Pre-Wired Combination Units



Unswitched Socket Outlets Protected by Both RCD & MCB

These units are supplied with both RCD (earth fault protection) and MCB (overcurrent protection). Units are supplied with “C” type MCB’s as standard.

Socket Rating

16 Amps
32 Amps
63 Amps

RCD Rating & Tripping

25 Amps 30MA
40 Amps 30MA
63 Amps 30MA

MCB Rating

16 Amps
32 Amps
63 Amps

Note: 16A & 32A units can be supplied with an **RCBO** (Earth Fault & Overcurrent Protection) in same module. Please ask for details.

Sockets available at IP44 Splashproof or IP67 Watertight

3 Poles



240V 2P+E

One Socket Outlet IP44 Protected by 1x RCD & 1x MCB			
16A	240	2P+E	880117
32A	240	2P+E	880121
63A	240	2P+E	880125
One Socket Outlet IP67 Protected by 1x RCD & 1x MCB			
16A	240	2P+E	880517
32A	240	2P+E	880521
63A	240	2P+E	880525

3 Poles



110V 2P+E

One Socket Outlet IP44 Protected by 1x RCD & 1x MCB			
16A	110	2P+E	880417
32A	110	2P+E	880421
63A	110	2P+E	880425
One Socket Outlet IP67 Protected by 1x RCD & 1x MCB			
16A	110	2P+E	880561
32A	110	2P+E	880563
63A	110	2P+E	880566

4 Poles



415V 3P+E

One Socket Outlet IP44 Protected by 1x RCD & 1x MCB			
16A	415	3P+E	880129
32A	415	3P+E	880133
63A	415	3P+E	880137
One Socket Outlet IP67 Protected by 1x RCD & 1x MCB			
16A	415	3P+E	880529
32A	415	3P+E	880533
63A	415	3P+E	880537

5 Poles



415V 3P+N+E

One Socket Outlet IP44 Protected by 1x RCD & 1x MCB			
16A	415	3P+N+E	880141
32A	415	3P+N+E	880145
63A	415	3P+N+E	880149
One Socket Outlet IP67 Protected by 1x RCD & 1x MCB			
16A	415	3P+N+E	880541
32A	415	3P+N+E	880545
63A	415	3P+N+E	880549

Illustrations show IP44

	Amperes	16			32			63		
		3	4	5	3	4	5	3	4	5
a	163	222	222	222	222	222	222	222	222	222
b	280	284	284	284	284	284	284	370	370	370
c	142	204	204	204	204	204	204	top 168	168	168
c								btm 178	178	178
d	243	267	267	267	267	267	267	303	303	303
e	155	160	160	168	168	168	168	200	200	200
f	130	123	123	123	123	123	123	135	135	135
g	6	6	6	6	6	6	6	6	6	6

Units rated at 125A also available

2 Gang Unswitched RCD Protected Sockets

Unswitched internally **pre-wired** units are supplied with RCD (for earth fault protection) with sensitivity of 30MA / 30MS as standard (others available upon request)

2x 16A Sockets = 40A RCD

2x 32A Sockets = 63A RCD

Sockets available at IP44 Splashproof or IP67 Watertight



Two Socket Outlets IP44 Protected by 1x RCD			
16A	240	2P+E	882216
32A	240	2P+E	883216
Two Socket Outlets IP67 Protected by 1x RCD			
16A	240	2P+E	882716
32A	240	2P+E	882732



Two Socket Outlets IP44 Protected by 1x RCD			
16A	110	2P+E	882214
32A	110	2P+E	883214
Two Socket Outlets IP67 Protected by 1x RCD			
16A	110	2P+E	882741
32A	110	2P+E	882733



Two Socket Outlets IP44 Protected by 1x RCD			
16A	415	3P+E	882316
32A	415	3P+E	882332
Two Socket Outlets IP67 Protected by 1x RCD			
16A	415	3P+E	882714
32A	415	3P+E	882743



Two Socket Outlets IP44 Protected by 1x RCD			
16A	415	3P+N+E	882146
32A	415	3P+N+E	882432
Two Socket Outlets IP67 Protected by 1x RCD			
16A	415	3P+N+E	882751
32A	415	3P+N+E	882753

Illustrations show IP44

	Amperes	16			32		
	Poles	3	4	5	3	4	5
a	222	222	222	222	222	222	
b	284	284	284	284	284	284	
c	204	204	204	204	204	204	
d	267	267	267	267	267	267	
e	155	160	160	168	168	168	
f	123	123	123	123	123	123	
g	6	6	6	6	6	6	

Units with 2x RCD or MCB available on request

Multi-Outlet Combination Units



Unswitched internally **pre-wired** units are supplied with RCD (for earth fault protection) with sensitivity of 30MA / 30MS as standard (others available upon request)

All units are IP44 splashproof (watertight IP67 or MCB / overcurrent protection available on request)

3 Gang

4 Gang



3x 16A Sockets Protected by 1x 40A RCDs
3x 32A Sockets Protected by 1x 80A RCDs

3 Gang Units

Fitted with RCD 30MA x1

A	V			
CURRENT	VOLTAGE	2P+E	3P+E	4P+E
16	110	883314		
	240	883316		
	415		883415	883515
32	110	883334		
	240	883336		
	415		883435	883545

Amperes	16			32		
	3	4	5	3	4	5
Poles	3	4	5	3	4	5
a	222	222	222	222	222	222
b	370	370	370	370	370	370
c	200	205	208	210	210	210
d	135	135	135	135	135	135

4x 16A Sockets Protected by 2x 40A RCDs
4x 32A Sockets Protected by 2x 63A RCDs

4 Gang Units

Fitted with RCD 30MA x2

A	V			
CURRENT	VOLTAGE	2P+E	3P+E	4P+E
16	110	884314		
	240	884316		
	415		884415	884515
32	110	884334		
	240	884336		
	415		884435	884545

Amperes	16			32		
	3	4	5	3	4	5
Poles	3	4	5	3	4	5
a	222	222	222	222	222	222
b	370	370	370	370	370	370
c	200	205	208	210	210	210
d	135	135	135	135	135	135

Switch-Interlocked RCD Protected Sockets

Switched and interlocked units incorporate a mechanical interlock mechanism which prevents the switch from being turned 'ON' until the plug is fully inserted. The plug cannot be withdrawn until the switch is turned to the 'OFF' position.

The switch can be padlocked in the 'OFF' position. Units are supplied with RCD (for earth fault protection) with sensitivity of 30MA/30MS as standard (others available upon request). ALL UNITS ARE INTERNALLY **PRE-WIRED**.

16A Socket = 25A RCD

32A Socket = 40A RCD

63A Socket = 63A RCD

Sockets available at IP44 Splashproof or IP67 Watertight

3 Poles



240V 2P+E

One Switched Interlocked Socket IP44 Protected by 1x 30MA RCD			
16A	240	2P+E	880448
32A	240	2P+E	880450
63A	240	2P+E	880452
One Switched Interlocked Socket IP67 Protected by 1x 30MA RCD			
16A	240	2P+E	880118
32A	240	2P+E	880122
63A	240	2P+E	880126

3 Poles



110V 2P+E

One Switched Interlocked Socket IP44 Protected by 1x 30MA RCD			
16A	110	2P+E	880466
32A	110	2P+E	880468
63A	110	2P+E	880470
One Switched Interlocked Socket IP67 Protected by 1x 30MA RCD			
16A	110	2P+E	880418
32A	110	2P+E	880422
63A	110	2P+E	880426

4 Poles



415V 3P+E

One Switched Interlocked Socket IP44 Protected by 1x 30MA RCD			
16A	415	3P+E	880454
32A	415	3P+E	880456
63A	415	3P+E	880458
One Switched Interlocked Socket IP67 Protected by 1x 30MA RCD			
16A	415	3P+E	880130
32A	415	3P+E	880134
63A	415	3P+E	880138

5 Poles



415V 3P+N+E

One Switched Interlocked Socket IP44 Protected by 1x 30MA RCD			
16A	415	3P+N+E	880460
32A	415	3P+N+E	880462
63A	415	3P+N+E	880464
One Switched Interlocked Socket IP67 Protected by 1x 30MA RCD			
16A	415	3P+N+E	880142
32A	415	3P+N+E	880146
63A	415	3P+N+E	880150

Illustrations show IP67

	16			32			63		
	3	4	5	3	4	5	3	4	5
a	134	134	134	134	134	134	180	180	180
b	365	365	365	365	365	365	460	460	460
c	117	117	117	117	117	117	160	160	160
d	348	348	348	348	348	348	440	440	440
e	136	136	143	152	152	158	191	191	191
f	389	389	389	399	399	399	500	500	500
g	6.5	6.5	6.5	6.5	6.5	6.5	8	8	8
h	8	8	8	8	8	8	6.5	6.5	6.5
Cable Entry	M25	M25	M25	M25	M25	M25	M32	M32	M32

One top and two bottom cable entries in size indicated above

Units rated at 125A also available

Switch-Interlocked Sockets Protected by Both RCD & MCB

These units are supplied with both RCD (earth fault protection) and MCB (overcurrent protection). Units are supplied with "C" type MCB's as standard. ALL UNITS ARE INTERNALLY **PRE-WIRED**.

Socket Rating

16 Amps
32 Amps
63 Amps

RCD Rating & Tripping

25 Amps 30MA
40 Amps 30MA
63 Amps 30MA

MCB Rating

16 Amps
32 Amps
63 Amps

Note: 16A & 32A units can be supplied with an **RCBO** (Earth Fault & Overcurrent Protection) in same module. Please ask for details.

Sockets available at IP44 Splashproof or IP67 Watertight

3 Poles



240V 2P+E

One Switched Interlocked Socket IP44 Protected by 1x 30MA RCD & 1x MCB			
16A	240	2P+E	880449
32A	240	2P+E	880451
63A	240	2P+E	880453
One Switched Interlocked Socket IP67 Protected by 1x 30MA RCD & 1x MCB			
16A	240	2P+E	880119
32A	240	2P+E	880123
63A	240	2P+E	880127

3 Poles



110V 2P+E

One Switched Interlocked Socket IP44 Protected by 1x 30MA RCD & 1x MCB			
16A	110	2P+E	880467
32A	110	2P+E	880469
63A	110	2P+E	880471
One Switched Interlocked Socket IP67 Protected by 1x 30MA RCD & 1x MCB			
16A	110	2P+E	880419
32A	110	2P+E	880423
63A	110	2P+E	880427

4 Poles



415V 3P+E

One Switched Interlocked Socket IP44 Protected by 1x 30MA RCD & 1x MCB			
16A	415	3P+E	880455
32A	415	3P+E	880457
63A	415	3P+E	880459
One Switched Interlocked Socket IP67 Protected by 1x 30MA RCD & 1x MCB			
16A	415	3P+E	880131
32A	415	3P+E	880135
63A	415	3P+E	880139

5 Poles



415V 3P+N+E

One Switched Interlocked Socket IP44 Protected by 1x 30MA RCD & 1x MCB			
16A	415	3P+N+E	880461
32A	415	3P+N+E	880463
63A	415	3P+N+E	880465
One Switched Interlocked Socket IP67 Protected by 1x 30MA RCD & 1x MCB			
16A	415	3P+N+E	880143
32A	415	3P+N+E	880147
63A	415	3P+N+E	880151

Illustrations show IP67

	16			32			63		
	3	4	5	3	4	5	3	4	5
a	134	134	134	134	134	134	180	180	180
b	365	365	365	365	365	365	460	460	460
c	117	117	117	117	117	117	160	160	160
d	348	348	348	348	348	348	440	440	440
e	136	136	143	152	152	158	191	191	191
f	389	389	389	399	399	399	500	500	500
g	6.5	6.5	6.5	6.5	6.5	6.5	8	8	8
h	8	8	8	8	8	8	6.5	6.5	6.5
Cable Entry	M25	M25	M25	M25	M25	M25	M32	M32	M32

One top and two bottom cable entries in size indicated above

Units rated at 125A also available

125A Unswitched RCD Protected Sockets

Unswitched internally **pre-wired** units are supplied with RCD (for earth fault protection) with sensitivity of 30MA / 30MS as standard (others available upon request)

All 125A Units are IP67 Watertight

Unswitched Socket Outlet IP67 Protected by 100A DP RCD

125A	240	2P+E	Unswitched socket	880632
------	-----	------	-------------------	--------

Unswitched Socket Outlet IP67 Protected by 125A DP RCD

125A	240	2P+E	Unswitched socket	880634
------	-----	------	-------------------	--------

Unswitched Socket Outlet IP67 Protected by 100A 4P RCD

125A	415	3P+E	Unswitched socket	880636
------	-----	------	-------------------	--------

Unswitched Socket Outlet IP67 Protected by 125A 4P RCD

125A	415	3P+E	Unswitched socket	880638
------	-----	------	-------------------	--------

Unswitched Socket Outlet IP67 Protected by 100A 4P RCD

125A	415	3P+N+E	Unswitched socket	880640
------	-----	--------	-------------------	--------

Unswitched Socket Outlet IP67 Protected by 125A 4P RCD

125A	415	3P+N+E	Unswitched socket	880642
------	-----	--------	-------------------	--------

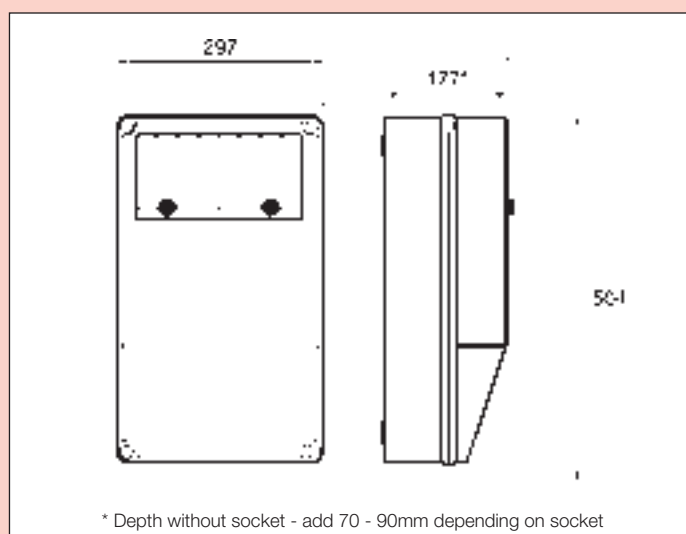

125A Switched-Interlocked RCD Protected Sockets

Switched and interlocked units incorporate a mechanical interlock mechanism which prevents the switch from being turned 'ON' until the plug is fully inserted. The plug cannot be withdrawn until the switch is turned to the 'OFF' position.

The switch can be padlocked in the 'OFF' position. Units are supplied with RCD (for earth fault protection) with sensitivity of 30MA / 30MS as standard (others available upon request).

All 125A Units are IP67 Watertight

Switch Interlocked Socket IP67 Protected by 100A DP RCD

125A	240	2P+E	Switch interlocked socket	880602
------	-----	------	---------------------------	--------

Switch Interlocked Socket IP67 Protected by 100A 4P RCD

125A	415	3P+E	Switch interlocked socket	880606
------	-----	------	---------------------------	--------

Switch Interlocked Socket IP67 Protected by 100A 4P RCD

125A	415	3P+N+E	Switch interlocked socket	880610
------	-----	--------	---------------------------	--------

Switch Interlocked Socket IP67 Protected by 125A DP RCD

125A	240	2P+E	Switch interlocked socket	880604
------	-----	------	---------------------------	--------

Switch Interlocked Socket IP67 Protected by 125A 4P RCD

125A	415	3P+E	Switch interlocked socket	880608
------	-----	------	---------------------------	--------

Switch Interlocked Socket IP67 Protected by 125A 4P RCD

125A	415	3P+N+E	Switch interlocked socket	880612
------	-----	--------	---------------------------	--------

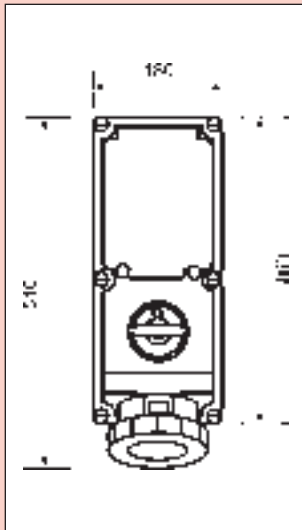

Cable entries:
Top M40
Bottom M40 / 50

Double enclosure switch interlocked units incorporate all the features of the above **PLUS** the added benefit of 70mm² terminals and more space for incoming cable terminating.

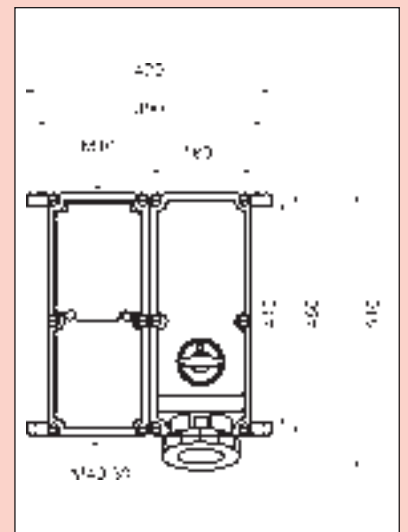

Switch Interlocked Double Enclosure Socket IP67 Protected by 125A 4P RCD

125A	415	3P+E	Switched interlocked double enclosure socket	884125
125A	415	3P+N+E	Switched interlocked double enclosure socket	885125

Single Socket Outlet on Back Box

CEE Norm U.K. offer a range of single panel sockets, either angled or straight, splashproof (IP44) or watertight (IP67) fitted to a plastic back box, internally **pre-wired**.

A	V			Part No.
16	110	3P	Angled socket IP44 on back box	653104
16	240	3P	Angled socket IP44 on back box	653106
16	415	4P	Angled socket IP44 on back box	653146
16	415	5P	Angled socket IP44 on back box	653156



IP44

112mm x 112mm x 120mm

A	V			Part No.
16	110	3P	Angled socket IP67 on back box	653104/WT
16	240	3P	Angled socket IP67 on back box	653106/WT
16	415	4P	Angled socket IP67 on back box	653146/WT
16	415	5P	Angled socket IP67 on back box	653156/WT



IP67

110mm x 110mm x 150mm

				Part No.
Back box 75 x 75 x 50mm to suit Cee Norm panel sockets with 75 x 75mm flange / 60 x 60mm fixings e.g. 16A 3 pin up to 32A 5 pin straight panel sockets				610010



A	V			Part No.
32	110	3P	Angled socket IP44 on back box	653134
32	240	3P	Angled socket IP44 on back box	653136
32	415	4P	Angled socket IP44 on back box	653148
32	415	5P	Angled socket IP44 on back box	653158



IP44

165mm x 120mm x 145mm



A	V			Part No.
32	110	3P	Angled socket IP67 on back box	653134/WT
32	240	3P	Angled socket IP67 on back box	653136/WT
32	415	4P	Angled socket IP67 on back box	653148/WT
32	415	5P	Angled socket IP67 on back box	653158/WT



IP67

180mm x 110mm x 160mm

All back boxes are supplied undrilled for cable entry unless otherwise requested.

16 	110	50 - 60	653240	4				
	240	50 - 60	653241	6				
	415	50 - 60			653270	6	653271	6
32 	110	50 - 60	653272	4				
	240	50 - 60	653273	6				
	415	50 - 60			653274	6	653275	6



2 Gang Surface Mounting Socket Outlet



Pre-wired
 Splashproof

Amperes	16			32			
	3	4	5	3	4	5	
Poles							
a	180	180	180	180	180	180	
b	105	105	105	105	105	105	
c	140	140	140	140	140	140	
d	80	80	80	80	80	80	

Enclosure normally for straight sockets

Amperes	16			32			
	3	4	5	3	4	5	
Poles							
a	165	245	245	245	245	245	
b	120	185	185	185	185	185	
c	130	155	155	160	160	160	
d	78	98	98	98	98	98	

With angled sockets



16 	110	50 - 60	653340	4				
	240	50 - 60	653341	6				
	415	50 - 60			653370	6	653371	6
32 	110	50 - 60	653372	4				
	240	50 - 60	653373	6				
	415	50 - 60			653374	6	653375	6



3 Gang Surface Mounting Socket Outlet

Pre-wired
 Splashproof

Amperes	16			32			
	3	4	5	3	4	5	
Poles							
a	245	335	335	335	335	335	
b	185	245	245	245	245	245	
c	150	195	195	195	195	195	
d	98	130	130	130	130	130	

16 	110	50 - 60	653440	4				
	240	50 - 60	653441	6				
	415	50 - 60			653470	6	653471	6
32 	110	50 - 60	653472	4				
	240	50 - 60	653473	6				
	415	50 - 60			653474	6	653475	6





4 Gang Surface Mounting Socket Outlet

Pre-wired
 Splashproof

Amperes	16			32			
	3	4	5	3	4	5	
Poles							
a	185	245	245	245	245	245	
b	245	335	335	335	335	335	
c	150	195	195	195	195	195	
d	98	130	130	130	130	130	

**Note: Angled sockets fitted as standard.
 Straight sockets can be fitted on special request.**

We reserve the right to change the enclosure sizes.

16 	110	50 - 60	653240/WT	4				
	240	50 - 60	653241/WT	6				
	415	50 - 60			653270/WT	6	653271/WT	6
32 	110	50 - 60	653272/WT	4				
	240	50 - 60	653273/WT	6				
	415	50 - 60			653274/WT	6	653275/WT	6



2 Gang Surface Mounting Socket Outlet

Pre-wired
 Watertight

Amperes	16		
Poles	3	4	5
a	180	180	180
b	105	105	105
c	140	140	140
d	80	80	80



With straight sockets

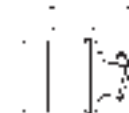

Amperes	16			32		
Poles	3	4	5	3	4	5
a	180	254	254	254	254	254
b	110	180	180	180	180	180
c	150	150	150	160	160	160
d	90	90	90	90	90	90

With angled sockets



16 	110	50 - 60	653340/WT	4				
	240	50 - 60	653341/WT	6				
	415	50 - 60			653370/WT	6	653371/WT	6
32 	110	50 - 60	653372/WT	4				
	240	50 - 60	653373/WT	6				
	415	50 - 60			653374/WT	6	653375/WT	6





3 Gang Surface Mounting Socket Outlet

Pre-wired
 Watertight

Amperes	16			32		
Poles	3	4	5	3	4	5
a	254	360	360	360	360	360
b	180	254	254	254	254	254
c	150	170	170	180	180	180
d	90	111	111	111	111	111



16 	110	50 - 60	653440/WT	4				
	240	50 - 60	653441/WT	6				
	415	50 - 60			653470/WT	6	653471/WT	6
32 	110	50 - 60	653472/WT	4				
	240	50 - 60	653473/WT	6				
	415	50 - 60			653474/WT	6	653475/WT	6



4 Gang Surface Mounting Socket Outlet

Pre-wired
 Watertight

Amperes	16			32		
Poles	3	4	5	3	4	5
a	180	254	154	254	254	254
b	254	360	360	360	360	360
c	150	170	170	180	180	180
d	90	111	111	111	111	111



**Note: Angled sockets fitted as standard.
Straight sockets can be fitted on special request.**

We reserve the right to change the enclosure sizes.

Heavy Duty Rubber In-line Combination Units

CEE NORM



Type & No. of Sockets							
A	V	Hz	Part No.	BS1363	BS4343	EARTH HR. POS.	RCD Rating
CURRENT	VOLTAGE	FREQUENCY		13A			30MA
16	110	50 - 60	653243		3	4	
	240	50 - 60	653244		3	6	
	110	50 - 60	653248		2	4	1x 40A
	240	50 - 60	653249		2	6	1x 40A
	110	50 - 60	653246		4	4	
	240	50 - 60	653247		4	6	
13	240	50 - 60	653242	2			1x 25A
13	240	50 - 60	653245	3			1x 40A
32	110	50 - 60	653250		2	4	
	240	50 - 60	653251		2	6	
	110	50 - 60	653254		3	4	
	240	50 - 60	653255		3	6	
	110	50 - 60	653252		1	4	1x 40A
	240	50 - 60	653253		1	6	1x 40A

Angled sockets fitted as standard

Rubber enclosure portable or can be wall mounted

Amperes	16			32		
	3	4	5	3	4	5
a	118	118	118	118	118	118
b	440	440	440	440	440	440
c	122	133	133	132	136	136
d	70	70	70	70	70	70
e	50	50	50	50	50	50

25mm cable entry gland is fitted

Straight socket and watertight versions available. Please ask for details.



**Plastic
Cross Distribution Unit**



Metal

**Cross distribution unit (plastic) - IP44 - suspensible
Appliance inlet and 3 socket outlets**

A	V		Part No.
16	110	2P+E	54956
16	240	2P+E	54566
16	415	3P+E	54280
16	415	3P+N+E	546

A	V		Part No.
32	110	2P+E	540247
32	240	2P+E	540755
32	415	3P+E	540364
32	415	3P+N+E	54567

Rubber distribution outlet unit (free standing). Fitted with various socket outlet combinations at IP44 or IP67. Fitted with cable entry gland. (input cable and plug available on request), or with appliance inlet. Contact CEE Norm U.K. for your specific requirements.

Extension outlet units 'E.O.U.' (metal) IP44 free standing with cable entry gland, with or without cable.

4 x 16A 110V 2P+E (without cable)
4 x 16A 110V 2P+E with 5M 1.5mm² yellow arctic cable and 16A 110V 2P+E plug

Part No.
555014
555015

Earth Monitoring Units

Earth Monitoring Protection - Earth Continuity Sensing

Earth Monitoring Protection equipment is designed to protect personnel from electric shock from portable electrical equipment. Equipment under such protection cannot be switched on before effective earth connection is proved, hence a shock from faulty equipment cannot occur. The earth conductor is continuously monitored. Hence should it become defective whilst an appliance is in operation, the supply will be automatically disconnected.

Earth Monitoring Protection will:

- Eliminate the shock hazard from contact with faulty portable electrical equipment.
- Reduce the possibility of death or injury resulting from a fall, possibly from a ladder, following even a non-lethal electric shock.
- Eliminate disconnections on load by providing quality electrical interlocking of plug and socket.



**Unit with EMU
(Earth Monitoring Unit
and RCD fitted)**

IP44 Socket with Earth Monitoring + RCD Protection				
A	V	3 Wire	RCD	Part No.
16	240	Using 6P+E Socket	25A 30MA	887241
32	240	Using 6P+E Socket	40A 30MA	887243
63	240	2P+E+Pilot	63A 30MA	887246



IP44 Socket with Earth Monitoring + RCD Protection				
A	V	3 Wire	RCD	Part No.
16	415	Using 6P+E Socket	25A 30MA	887441
32	415	Using 6P+E Socket	40A 30MA	887443
63	415	3P+E+Pilot	63A 30MA	887446



A	V	3 Wire	RCD	Part No.
16	415	Using 6P+E Socket	25A 30MA	887451
32	415	Using 6P+E Socket	40A 30MA	887453
63	415	4P+E+Pilot	63A 30MA	887456

	Amperes	16			32		63		
		7	7	3	4	5			
	Poles	7	7	3	4	5			
	a	222	222	297	297	297			
	b	370	370	504	504	504			
	c top	168	168	182	182	182			
	c bottom	178	178	234	234	234			
	d	303	303	366	366	366			
	e	160	168	255	255	255			
	f	135	135	177	177	177			
	g	6	6	6	6	6			

Units with additional overcurrent (MCB) protection are also available

IP67 watertight units also available

CEE Norm U.K. can offer a wide variety of 'Made to Order' units, utilising plastic or rubber surface mounting or portable enclosures fitted with our plugs and sockets and protective devices as required.

If your requirement is not covered by the CEE Norm U.K. standard range, please contact our sales office to discuss your requirements.

Below are some examples of 'Made to Order' units:

Rubber Enclosures



Portable rubber distribution unit with multi socket outlets and RCD / MCB protection



Portable rubber block with inlet - multi socket outlets and RCD / MCB protection



Portable rubber distribution unit with appliance inlet and multi socket outlets RCD/MCB protection and phase indicator neons

Available with various socket outlet and RCD / MCB options

Note: 'Made to Order' units have to be ordered in writing with full specification.

The order may not be cancelled without incurring penalty charges once manufacturing has commenced.

Plastic Enclosures



- 16A 110V 3P or
- 16A 240V 3p
- RCD or MCB protection



- Window and Din Rail
- 9 or 13 module
- Enclosures with various socket and RCD / MCB options



Surface socket with on-off switch



16A 240V 3P socket RCD protected (small vertical enclosure)



Surface appliance inlet with on-off switch



6 way socket outlets



Multi socket outlet unit on stand



Special 'splitter' distribution unit (military version shown)

Available with various socket outlet and RCD / MCB options

Note: 'Made to Order' units have to be ordered in writing with full specification.

The order may not be cancelled without incurring penalty charges once manufacturing has commenced.

Notes:

Specialist Applications and Accessories



Chemical and Heavy Industry



Harbour installation containers, ship yards and shipping lines



Mining and tunnelling

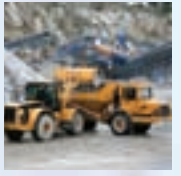

Camping and caravanning



Building and construction industry



Food processing and packaging

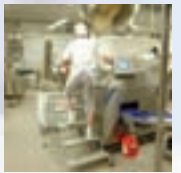

Agriculture and farming



Military applications

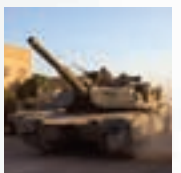

Industrial and commercial properties



Power generation and distribution

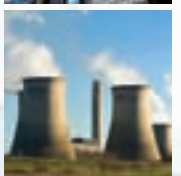

Oil and gas (non hazardous areas)

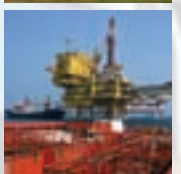

Film, TV and outdoor events

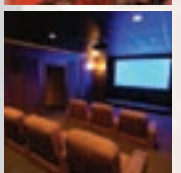

Caravan Hook-Up Units & Accessories

page 132

Garage 'Utility' Units & Shower Units

page 135

Film - TV & Events Distribution Equipment

page 136

Window For Enclosures

page 138

CEE Norm U.K. Ltd manufacture a wide range of equipment for distribution of power on caravan parks, campsites and mobile home parks.

Whilst some of the CEE Norm U.K. combination units and/or multi-outlet units to standard specification could be used for the above mentioned sites, CEE Norm U.K. have manufactured a range of **hook-up units** where local power points are required.

CEE Norm U.K. **standard** specifications cover plastic IP55 enclosure with 1, 2, 3 and 4 gang 16A 240V 3P IP44 socket outlets protected for earth fault and overcurrent protection.

IEE wiring regulations 17th edition require that each individual socket outlet is protected for earth fault and overcurrent.

For single socket units we fit an RCD (earth fault protection) and MCB (overcurrent protection) although an RCBO can also be fitted.

For 2, 3 or 4 gang units, we fit an RCBO (earth fault and overcurrent protection) for each socket.

Digital readout meters (kilowatt hour meters) can be incorporated into CEE Norm U.K. hook-up units. The table below lists CEE Norm U.K. **standard** hook-up units. For 'special made to order hook-up units' or 'add ons', please refer to the following pages.

Standard hook-up units IP55 enclosures / IP44 sockets 30MA RCDs

Part No.	A	V	Socket 2P+E	RCD 30MA	MCB	Reset Window	Kilowatt Hour Meter	16mm Terminals as Standard
886611	16	240	1	25A	10A	Yes	No	No
886617	16	240	1	25A	16A	Yes	No	No
886620	16	240	2	2x 10A	RCBO	Yes	No	No
886626	16	240	2	2x 16A	RCBO	Yes	No	No
886630	16	240	3	3x 10A	RCBO	Yes	No	No
886636	16	240	3	3x 16A	RCBO	Yes	No	No
886633	16	240	4	4x 10A	RCBO	Yes	No	No
886634	16	240	4	4x 16A	RCBO	Yes	No	No
886640	16	240	1	25A	16A	Yes	Yes	Yes
886632	32	240	1	40A	32A	Yes	Yes	Yes

Part No.	
880.1.2	1.2 metre galvanised stake
880.1.5	1.5 metre galvanised stake

Caravan Hook-Up Units & Accessories

Standard all insulated IP55 plastic enclosures fitted with socket outlet(s) to BS EN 60309-2 / BS 4343 with RCD's and MCB's behind re-set window and Kilowatt hour meter (where fitted) behind closed window.

16mm² terminals and/or brass gland plates can be requested as an 'add on'.

Please contact CEE Norm U.K. sales office for details and costs.

The plastic enclosures and brass gland plates (where fitted) are supplied undrilled unless otherwise requested.

Typical **standard** examples of **hook-up units**.



Part No.
886611
886617



Part No.
886620
886626



Part No.
886630
886636



Part No.
886633
886634



Part No.
886640



Part No.	
880.1.2	1.2 metre galvanized stake
880.1.5	1.2 metre galvanized stake

'Made to Order' hook-up units

In addition to the range of standard units for caravan, camping and mobile home sites, CEE Norm U.K. offer a 'Made to Order' service where customers' requirements extend to different socket layouts, higher IP ratings, different RCD and/or MCB requirements etc.

Contact our sales office with your specification.



Typical IP67 2 gang unit

Caravan Accessories



Part No.

254

16A 240V 2P+E
Caravan appliance inlet IP44



Part No.

119

16A 240V 2P+E
Padlockable wall socket IP44



Part No.

219

16A 240V 2P+E
Plug which can be padlocked to (padlockable) socket IP44



Part No.

12006

16A 240V 2P+E
Padlockable panel socket IP44

Other 16A 240V 2P+E equipment (non padlockable) in this catalogue may also be suitable for caravan / camping applications.

Garage 'Utility' Units & Shower Units

CEE Norm U.K. garage units comprise a quality plastic IP55 enclosure, a 2 pole 30MA RCD and 2 nos. single pole 'B' type MCB, pre-wired ready to wire into RCD.

Part No.	RCD	MCBs
GAR 251606	25A	16A+6A
GAR 401606	40A	16A+6A
GAR 403206	40A	32A+6A
GAR 403216	40A	32A+16A
GAR 404006	40A	40A+6A



Typical garage unit

CEE Norm U.K. shower units comprise a quality plastic IP55 enclosure, a 2 pole 30MA RCD and a single pole 'B' type MCB, pre-wired ready to wire into RCD.

Part No.	RCD	MCBs
SHO 6340	63A	40A
SHO 6350	63A	50A



Typical shower unit

CEE Norm U.K. black bodied plugs (line male) and sockets (line female) connectors and female chassis (panel mounting socket) as preferred in the film and TV industry.

The front end of plugs and the lid of sockets are colour coded blue for 240V identification.

The terminals are screw connect.

Part No.	A	V			
210348	16	240	2P+E	Plug	IP44 black body with short cable sleeve
310095	16	240	2P+E	Connector	IP44 black body with short cable sleeve
130036	16	240	2P+E	Panel Socket	IP44 black body 56 x 56mm flange
21969	16	240	2P+E	Plug	IP44 black body with cable gland
31832	16	240	2P+E	Connector	IP44 black body with cable gland
21970	32	240	2P+E	Plug	IP44 black body with cable gland
31833	32	240	2P+E	Connector	IP44 black body with cable gland



CEE Norm U.K. rubber distribution units 'Distro Units' are usually 'Made to Order' to customer specifications.

With a range of different sized portable rubber enclosures, we can fit our quality male / female connectors with RCD / MCB or RCBO protection if required.

From simple units to the more complex 16A - 125A or 'SOCOPEX' etc., please contact our sales office with your requirements.

Some typical examples:



Window for Enclosures



- Window with Blanking Strip Cut-outs
- Click closure



Part No.	Module	a	b
5881	2	55	40.5
5890	4	91	76.5
5899	6	127	112.5
58009	8	162	147.5
58018	12	234	220
58027	13	257.5	248.5



- Window without Blanking Strip Cut-outs
- Click closure



Part No.	Module	a	b
5882	2	55	37
5891	4	91	73
58001	6	127	109
58010	8	162	144.5
58019	12	234	217
58028	13	257.5	240



- Window with Blanking Cut-outs and Din Rail
- Click closure

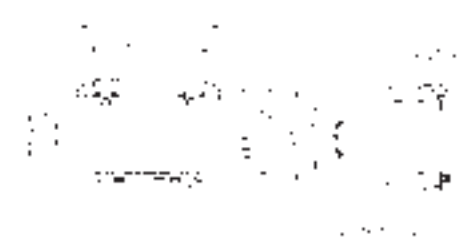

Part No.	Module	a	b
5885	2	55	40.5
5894	4	91	76.5
58004	6	127	112.5
58013	8	162	147.5
58022	12	234	220
58031	13	257.5	248.5



- Lock & 2 keys set
- Suitable only for the above windows
- Optional extra in addition to the click closure

Part No.
58037



- Din screw
- Suitable only for the above windows
- Optional extra in addition to the click closure
- 1 Din screw for 2 module window
- 2 Din screws for 4+ module windows

Part No.
58036

Military Applications



Chemical and Heavy Industry



Harbour installation containers, ship yards and shipping lines



Mining and tunnelling

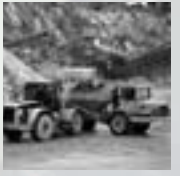

Camping and caravanning



Building and construction industry

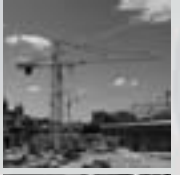

Food processing and packaging



Agriculture and farming

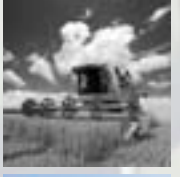

Military applications

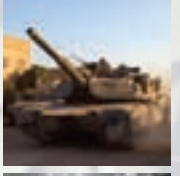

Industrial and commercial properties



Power generation and distribution



Oil and gas (non hazardous areas)

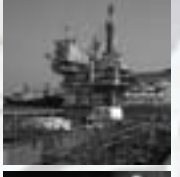

Film, TV and outdoor events

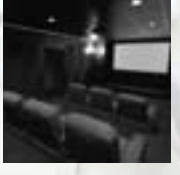

Military Plugs & Sockets

Military style 'Green' (RAL 6031-FP) IP67 plugs and sockets are available in 16A - 125A in a variety of voltages, with standard earth pin positions to prevent the possibility of connecting items of different voltages or frequencies by mistake.

Explanations concerning the standard

In order to obtain CEE plug-type devices that meet the requirements of the military sector, the standards VG 96919 and VG 96926 were drafted by the Electrotechnics standards office of DIN [German Standards Institute] in cooperation with the industry and with the BWB [Federal Agency for Defence Technology and Procurement].

Anyone is free to use these VG standards [defence equipment standards]. They are to be regarded as "recognised rules of the technology".

The standards constitute a measure for perfect technical behaviour. This measure is also of importance within the framework of the legal system.

One may be obliged to use them on account of legal or administrative regulations, as well as on account of contracts or for other legal reasons.

Plug-type devices that have been approved by the BWB must bear the VG standard main number and the VDE mark. The basis for VG approval is passing the type test according to the VG standard. The products approved by the BWB are listed with their manufacturers in the standards series VG 95212-LZB (list of approved components).

In view of the special nature of these products, please contact our sales office with your requirements.

Certain products comply with NATO defence specification. Details available on request.



- Almost all 16A and 32A plug-type devices are Quick-Connect plug devices, i.e. maintenance-free connection technology
- Suitable for all conductor types and conductor cross-sections through cage clamp technology
- The terminal is open when supplied, and is closed and locked by pressing in the colour-coded contact slide



- All plugs and couplings with sealing cap



- Heat resistant insert



- Nickel-plated contacts



Safe, Robust, Easy to Install

Product Code / Page Index



Part No.	Page	Part No.	Page	Part No.	Page	Part No.	Page	Part No.	Page	Part No.	Page	Part No.	Page
112	22	415	78	546	126	1164	22	1286	28	1395	28	2198	42
113	22	416	78	712	107	1183	24	1287	28	1396	28	2199	42
114	22	417	78	713	107	1186	24	1288	28	1397	28	2251	102
116	92	418	78	714	107	1200	28	1299	28	1398	28	2252	102
117	92	419	78	740	107	1201	26	1301	92	1399	28	2266	102
118	92	420	78	830	52	1202	26	1304	26	1634	34	2267	102
119	134	421	78	831	52	1204	92	1305	26	1635	34	2402	46
129	28	422	78	832	52	1205	28	1306	26	1637	34	2410	92
130	26	423	78	833	52	1206	28	1307	26	1644	34	2411	92
131	26	425	78	834	52	1207	26	1308	26	1693	34	2412	92
132	26	426	78	835	52	1208	26	1309	26	2104	40	2413	44
134	26	427	78	837	52	1216	26	1310	26	2125	70	2414	44
136	26	428	78	1104	22	1217	26	1311	26	2126	70	2415	44
169	34	429	78	1106	22	1218	26	1312	26	2129	70	2460	44
203	40	430	78	1107	22	1219	26	1313	26	2130	70	2461	44
204	40	431	78	1110	22	1220	26	1314	26	2131	92	2462	44
219	134	432	78	1111	22	1221	26	1315	26	2132	92	2463	44
224	102	433	78	1112	22	1222	92	1319	26	2133	92	2464	44
225	102	435	78	1115	22	1223	92	1320	26	2136	70	2465	44
226	102	436	78	1116	22	1224	92	1321	26	2137	70	2469	44
227	102	437	78	1117	22	1225	26	1322	26	2138	70	2470	44
230	40	438	78	1119	92	1226	26	1323	26	2141	70	2471	44
231	40	439	78	1120	92	1227	26	1324	26	2142	70	2472	46
232	40	440	80	1121	92	1228	26	1325	92	2143	92	2473	46
233	40	441	80	1122	22	1229	26	1326	92	2144	92	2474	46
234	40	442	80	1123	22	1230	26	1327	92	2145	92	2475	46
235	40	443	80	1124	22	1231	26	1331	26	2148	70	2476	46
236	40	445	80	1125	22	1232	26	1332	26	2149	40	2477	46
240	44	446	80	1126	22	1233	26	1333	26	2150	40	2481	46
242	44	447	80	1127	22	1234	92	1356	28	2151	40	2482	46
244	44	448	80	1128	92	1235	92	1357	28	2152	92	2483	46
245	44	449	80	1129	22	1236	92	1358	28	2153	40	2484	46
246	44	450	80	1130	22	1237	26	1359	28	2154	40	2485	46
247	44	451	80	1134	22	1238	26	1360	28	2155	40	2486	46
248	44	452	80	1135	22	1239	26	1361	28	2180	42	2487	46
249	44	453	80	1136	22	1265	28	1365	28	2181	42	2488	46
254	134	455	80	1141	22	1266	28	1366	28	2182	42	2489	46
260	48	456	80	1142	22	1267	28	1367	28	2183	42	2493	46
261	48	457	80	1146	22	1268	28	1368	28	2184	42	2494	46
262	48	458	80	1147	22	1269	28	1369	28	2185	42	2495	46
263	48	459	80	1148	22	1270	28	1370	28	2187	42	2600	48
264	48	460	80	1153	22	1274	28	1371	28	2188	42	2601	48
265	48	461	80	1154	22	1275	28	1372	28	2189	42	2604	48
303	58	462	80	1156	22	1276	28	1373	28	2190	42	2610	48
304	58	463	80	1157	22	1277	28	1374	28	2191	42	2611	48
330	58	465	80	1158	22	1278	28	1375	28	2192	42	2612	48
410	78	466	80	1159	22	1279	28	1376	28	2193	42	2613	48
411	78	467	80	1160	22	1280	28	1380	28	2194	42	2614	48
412	78	468	80	1161	22	1281	28	1381	28	2195	42	2615	48
413	78	469	80	1163	22	1282	28	1382	28	2197	42	2616	48

Product Code / Page Index



Part No.	Page	Part No.	Page	Part No.	Page	Part No.	Page	Part No.	Page	Part No.	Page	Part No.	Page
2617	48	2759	50	2880	50	4112	78	4418	80	4613	80	11445	24
2618	48	2760	50	2881	50	4113	78	4419	80	4614	80	11446	24
2622	48	2761	50	2882	50	4114	78	4420	80	4616	80	11447	24
2623	48	2762	50	2899	52	4116	78	4422	80	4617	80	11476	24
2624	48	2763	50	3104	58	4117	78	4423	80	4618	80	11477	24
2625	48	2767	50	3108	58	4118	78	4424	80	4619	80	11479	24
2626	48	2768	50	3109	58	4119	78	4425	80	4620	80	11480	94
2627	48	2769	50	3112	58	4120	78	4427	80	5881	138	11481	94
2628	48	2770	50	3124	60	4211	78	4428	80	5882	138	11482	94
2629	48	2771	50	3125	72	4212	78	4429	80	5885	138	11483	94
2630	48	2772	50	3126	72	4213	78	4430	80	5890	138	11542	96
2634	48	2773	50	3129	72	4214	78	4431	80	5891	138	11556	86
2635	48	2774	50	3130	72	4216	78	4433	80	5894	138	11578	96
2636	48	2775	50	3131	92	4217	78	4434	80	5899	138	11634	96
2637	48	2779	50	3132	92	4218	78	4435	80	7130	107	11635	96
2638	48	2780	50	3133	92	4219	78	4436	80	7132	107	11895	66
2639	48	2781	50	3135	72	4220	78	4438	80	7134	107	11905	66
2640	48	2782	50	3136	72	4311	78	4439	80	7139	107	11912	66
2641	48	2783	50	3137	72	4312	78	4440	80	7302	107	11918	66
2642	48	2784	50	3138	72	4313	78	4441	80	7303	107	11919	66
2646	48	2785	50	3141	72	4314	78	4442	80	7312	107	11922	66
2647	48	2786	50	3142	72	4316	78	4511	80	7409	107	11948	66
2655	48	2787	50	3143	92	4317	78	4512	80	7410	107	11949	66
2656	48	2791	50	3144	92	4318	78	4513	80	7415	107	11956	66
2657	48	2792	50	3145	92	4319	78	4514	80	11042	93	11962	66
2659	48	2793	50	3148	72	4320	78	4516	80	11127	93	12000	28
2660	48	2794	50	3149	58	4354	78	4517	80	11190	24	12001	28
2662	48	2795	50	3150	58	4355	78	4518	80	11275	93	12002	28
2663	48	2796	50	3151	58	4356	78	4519	80	11302	22	12003	28
2665	48	2797	50	3152	92	4357	78	4520	80	11303	22	12004	28
2666	48	2798	50	3153	58	4359	78	4522	80	11304	22	12006	134
2705	50	2799	50	3154	58	4360	78	4523	80	11305	22	12100	28
2706	50	2811	48	3180	60	4361	78	4524	80	11306	22	12101	28
2707	50	2814	48	3181	60	4362	78	4525	80	11307	22	12102	28
2708	50	2815	48	3182	60	4363	78	4527	80	11308	22	12103	28
2709	50	2817	48	3183	60	4365	78	4528	80	11309	22	12104	28
2735	50	2826	48	3184	60	4366	78	4529	80	11310	22	12106	28
2736	50	2827	48	3185	60	4367	78	4530	80	11311	22	12107	28
2737	50	2830	48	3187	60	4368	78	4531	80	11312	22	12108	28
2738	50	2831	48	3188	60	4370	78	4533	80	11313	22	12134	26
2739	50	2833	50	3190	60	4371	78	4534	80	11314	22	12135	26
2740	50	2834	50	3191	60	4372	78	4535	80	11315	22	12136	26
2742	50	2835	50	3192	60	4373	78	4536	80	11316	22	12137	26
2743	50	2836	50	3193	60	4374	78	4538	80	11317	22	12138	26
2744	50	2837	50	3194	60	4411	80	4539	80	11436	24	12144	93
2751	50	2838	50	3195	60	4412	80	4540	80	11437	24	12174	93
2755	50	2860	50	3197	60	4413	80	4541	80	11438	24	12753	68
2756	50	2861	50	3198	60	4414	80	4542	80	11439	24	12757	68
2757	50	2873	48	3199	60	4416	80	4611	80	11440	24	12760	68
2758	50	2876	50	4111	78	4417	80	4612	80	11441	24	12761	68

Notes:

Notes:

Notes:

including

QUICK  CONNECT[®]

CEENORM UK Ltd

**Distributors/Manufacturers of:
Industrial Plugs, Sockets and Combination Units
to BS EN 60309-2 BS 4343 CEE17**

Unit 2 Highbridge Court Stafford Park 1 Telford Shropshire TF3 3BD United Kingdom

T **01952 212 700** sales@ceenorm.co.uk
F **01952 212 711** www.ceenorm.co.uk

Design and Production by www.carljonesdesign.com

X-ON Electronics

Largest Supplier of Electrical and Electronic Components

Click to view similar products for [ceenorm](#) manufacturer:

Other Similar products are found below :

[11949](#) [112001](#) [3126](#) [2125](#) [3138](#) [21013-TLS](#) [13668](#) [21001-TLS](#) [31001-TLS](#)