

Gradateur angle de phase

Phase angle controller



SO465420

Output : 200-480VAC 50A
Analog Input : 4-20mA

- ❑ Relais statique à entrée analogique permettant un contrôle en puissance de charge résistive par une variation en angle de phase
Analog switching Solid State Relay works for resistive load power control in accordance with the phase angle principle.
- ❑ Gamme en courant des SO4 : 35 à 125A
SO4. current range : 35 to 125A
- ❑ Protection contre les surtensions par varistor intégré
Overvoltage protection by varistor.
- ❑ Plage de fréquence réseau : 40 à 70 Hz auto-adaptable
Main frequency range : 40 to 70Hz with self adaptation
- ❑ Entrée analogique 4-20mA (@Uc<7V) et led de visualisation
4-20mA control current and Green LED visualization on the input.
- ❑ Construit en conformité aux normes EN60947-4-3 (IEC947-4-3) et EN60950/VDE0805 (Isolement renforcé)
Designed in conformity with EN60947-4-3 (IEC947-4-3) and EN60950/VDE0805 (Reinforced Insulation)
- ❑ Protection IP20 par volets sur les bornes.
IP20 protection by flaps on terminals.



Microcontroller Inside



Dimensions :

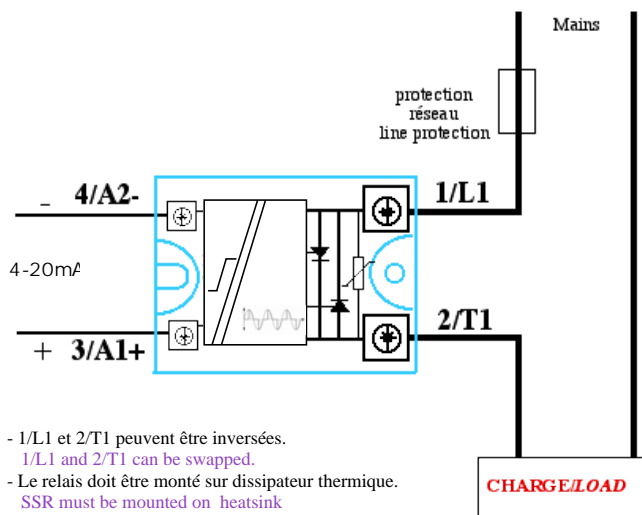
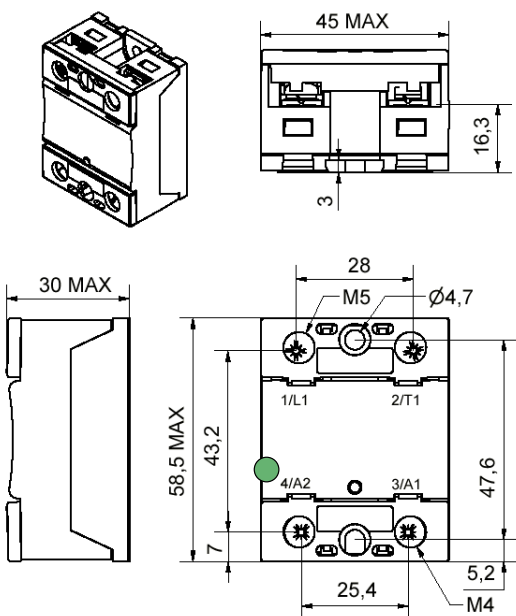

Application typique / Typical application:
10kW resistance (AC-51) - 230 VAC 50hz

Proud to serve you

Caractéristiques d'entrée / Control characteristics (at 25°C)

Paramètre / Parameter	Symbol	DC			Unit
		Min	Typ	Max	
Plage de courant de commande / Control current range	Ic		4-20		mA
plage de tension / Voltage range	Vc	-0,6V	-	7,5	V
Impédance d'entrée / Dynamic impedance	R		150		Ω
LED d'entrée / Input LED		verte / green			
Protection Inverse / Reverse polarity protection		oui / yes			
Courant maximum / Maximum allowed input current	Imax		50		mA

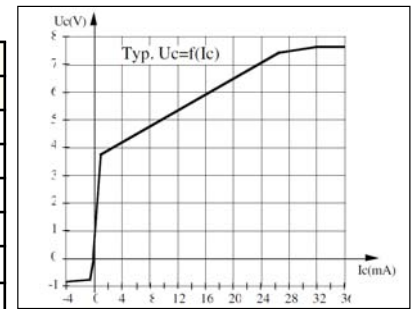
**Caractéristiques de sortie / Output characteristics (at 25°C)**

Paramètre / Parameter	Conditions	Symbol	Min	Typ.	Max	Unit
Plage de tension utilisation / Operating voltage range		Ue	200	-	480	V rms
Tension de crête / Peak voltage	@ 1mA	Up	1200			V
Tension amorçage / Latching voltage	Ie nom	Ua			20	V
Courant nominal / nominal current (AC-51)	voir/ see fig.2	Ie AC-51	0,1		50	A rms
Courant surcharge / Non repetitive overload current	tp=10ms (Fig. 3)	Itsm	550	720		A
Chute directe à l'état passant / On state voltage drop	@ 25°C	Vt			0,9	V
Résistance dynamique / On state dynamic resistance		rt			12	mΩ
Puissance dissipée (max) / Output power dissipation (max)		Pd	0,9x0,9xIe + 0,012xIe ²			W
Courant de fuite à l'état bloqué / Off state leakage current	@Ue typ, 50Hz	Iik			2	mA
Temps d'initialisation / init time	@ switch on 50Hz	ti			240	ms
Temps de retard / delay time	@ 50Hz	td max			60	ms
Temps de reponse / rise, fall time	@ 50Hz, dUI=63%	tr max			20	ms
Fréquence utilisation / Operating frequency range	f mains	f	40	50-60	70	Hz
dv/dt à l'état bloqué / Off state dv/dt		dv/dt	500			V/μs
di/dt max / Maximum di/dt non repetitive		di/dt			50	A/μs
Izt (<10ms)		I ² t	1500	2500		A ² s
Immunité / Conducted immunity level	IEC/EN61000-4-4 (bursts)		4kV criterion B			
Immunité / Conducted immunity level	IEC/EN61000-4-5 (surge)		4kV criterion B			
Protection surtension interne / Internal overvoltage protection	Varistor 510V	Uclamp	820(@1mA)			V
Protection court-circuit / Short circuit protection	voir/ see page 6	Example	Fuse Ferraz gRC 25A/32A/50A			

Caractéristiques générales / General characteristics (at 25°C)

Isolement entrée/sortie - Input to output insulation	Ui	4000		VRMS
Isolation sortie/ semelle - Output to case insulation	Ui	4000		VRMS
Résistance Isolement / Insulation resistance	Ri	1000 (@500VDC)		MΩ
Tenue aux tensions de chocs / Rated impulse voltage	Uimp	4000		V
Degré de protection / Protection level / CEI529		IP20		
Degré de pollution / Pollution degree	-	2		
Vibrations / Vibration withstand 10 -55 Hz according to CEI68		1,5		mm
Tenue aux chocs / Shocks withstand according to CEI68	-	30/50		g
Résistance thermique jonction/semelle Thermal resistance junction to case	Rthj/c	0,45		K/W
Température de fonctionnement / Ambient temperature (no icing, no condensation)	-	-40 /+90		°C
Température de stockage/ Storage temperature (no icing, no condensation)	-	-40/+125		°C
Humidité relative / Ambient humidity	HR	40 to 85		%
Poids/ Weight		65		g
Conformité / Conformity		EN60947-4-3 (IEC947-4-3)		
Conformité / Conformity		VDE0805/EN60950 UL/cUL		
plastique du boîtier / Housing Material		PA 6 UL94VO		
Semelle / Base plate		Aluminium, nickel-plated		

Fig. 2 Courbes thermiques & Choix dissipateur thermique / *Thermal curves and heatsink choice*

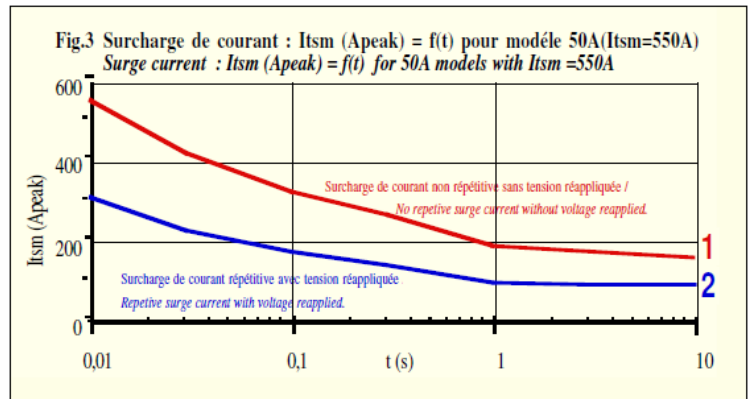
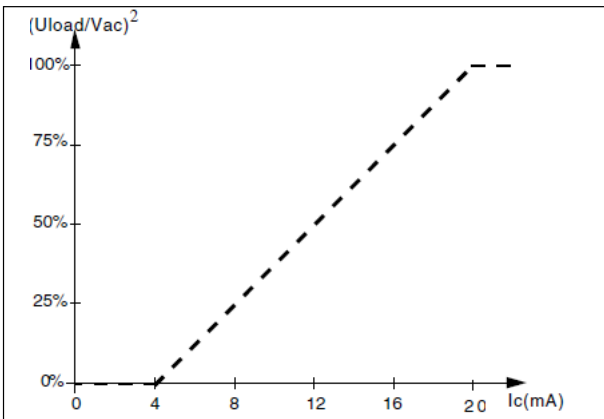
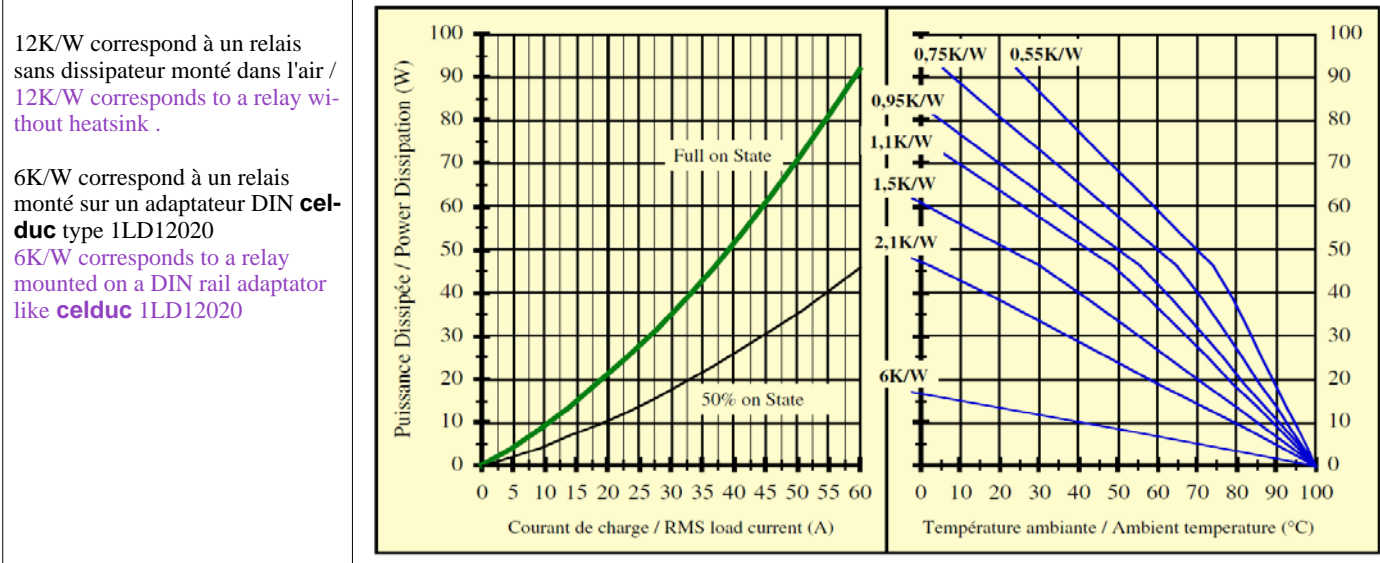

Fig.3 Caractéristique de transfert, linéarisé en U²

Transfer characteristic with U² linearisation.

Avec une charge résistive constante cette caractéristique permet d'avoir une réponse linéaire en puissance.

With a constant resistive load this characteristic leads a linear power transfer.

Vac : Tension eff. réseau / *Mains voltage (rms)*

R load : Résistance de la charge / *Resistive load*

$P(I_e) = U_{load}^2 / R_{load}$, $P_{max} = V_{ac}^2 / R_{load}$

$(U_{load}/V_{ac})^2 = P(I_e) / P_{max} = (I_e - 4mA) / 16mA$

$P(I_e) = P_{max} \cdot (I_e - 4mA) / 16mA$

1 - Itsm non répétitif sans tension réappliquée est donné pour la détermination des protections.

1 - *No repetitive Itsm is given without voltage reapplied. This curve is used to define the protection (fuses).*

2 - Itsm répétitif est donné pour des surcharges de courant (Tj initiale=70°C). Attention : la répétition de ces surcharges de courant diminue la durée de vie du relais.

2 - *Repetitive Itsm is given for inrush current with initial Tj = 70°C. In normal operation, this curve mustn't be exceeded. Be careful, the repetition of the surge current decreases the life expectancy of the SSR.*

-> **Attention !** les relais à semi-conducteurs ne procurent pas d'isolation galvanique entre le réseau et la charge. Ils doivent être utilisés associés à un disjoncteur avec propriété de sectionnement ou similaire, afin d'assurer un sectionnement fiable en amont de la ligne dans l'hypothèse d'une défaillance et pour tous les cas où le relais doit être isolé du réseau (maintenance ; non utilisation sur une longue durée...).





-> **Warning !** semiconductor relays don't provide any galvanic insulation between the load and the mains. Always use in conjunction with an adapted circuit breaker with isolation feature or a similar device in order to ensure a reliable insulation in the event of wrong function and when the relay must be insulated from the mains (maintenance ; if not used for a long duration ...).



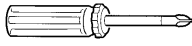
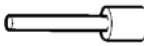

Raccordement / Connections

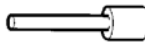

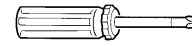
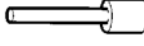

Directement avec fils avec ou sans embouts/
Direct connection with wires with or without ferrules

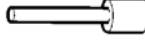
Avec cosses/
With ring terminals



okpac® Raccordement d'entrée / Control wiring				Modèle de tournevis / Screwdriver type	Couple de serrage recommandé Recommended Torque
Nombre de fils / Number of wires					
1		2		 POZIDRIV 2	M4 N.m 1,2
Fil rigide (sans embout) SOLID (No ferrule)	Fil multibrins (avec embout) FINE STRANDED (With ferrule)	Fil rigide (sans embout) SOLID (No ferrule)	Fil multibrins (avec embout) FINE STRANDED (With ferrule)		
 0,75 ... 2,5 mm ² AWG18...AWG14	 0,75 ... 2,5 mm ² AWG18...AWG14	 0,75 ... 2,5 mm ² AWG18...AWG14	 0,75 ... 2,5 mm ² AWG18...AWG14		

okpac® Raccordement de puissance / Power wiring				Modèle de tournevis / Screwdriver type	Couple de serrage recommandé Recommended Torque
Nombre de fils / Number of wires					
1		2		 POZIDRIV 2	M5 N.m 2
Fil rigide (sans embout) SOLID (No ferrule)	Fil multibrins (avec embout) FINE STRANDED (With ferrule)	Fil rigide (sans embout) SOLID (No ferrule)	Fil multibrins (avec embout) FINE STRANDED (With ferrule)		
 1,5 ... 10 mm ² AWG16...AWG8	 1,5 ... 6 mm ² AWG16...AWG10	 1,5 ... 10 mm ² AWG16...AWG8	 1,5 ... 6 mm ² AWG16...AWG10		

<p>Puissance avec cosses / Power with ring terminals.</p>  <p>W max =12,6mm</p> <p>16 mm² (AWG6)</p> <p>25 mm² (AWG4)</p> <p>35mm² (AWG2 /AWG3)</p> <p>50mm² (AWG0 /AWG1)</p>   <p>Des cosses et kits d'adaptation peuvent être fournis : voir relais forte puissance et documentation connexion forte puissance/ Suitable ring terminals and special kit for high current can be delivered: see high power SSR and data-sheet for power connexion.</p>	<p>Options : FASTONS : Nous consulter/ Consult us</p> <p>KIT adaptation fort courant / Special kit for high current:</p> <p>1LK00700</p> <p>35mm² (AWG2)</p> <p>50mm² (AWG0)</p> <p>Pour les forts courants, le volet doit être enlevé (perte IP20). For high currents, power flap must be removed (no IP20)</p> 
--	--



Montage /Mounting:

-> Les relais statiques de la gamme **okpac®** doivent être montés sur dissipateur thermique. Une gamme étendue de dissipateurs est disponible. Voir exemples ci dessous et la gamme "WF" sur www.celduc.com.

okpac® SSRs must be mounted on heatsinks. A large range of heatsinks is available. See below some examples and "WF" range on www.celduc.com.

-> Pour le montage du relais sur dissipateur utiliser de la graisse thermique ou un "thermal pad" haute performance spécifié par **celduc®**. Une version autocollante précollée sur le relais est aussi disponible: nous consulter / For heatsink mounting, it is necessary to use thermal grease or thermal pad with high conductivity specified by **celduc®**. An adhesive model mounted by **celduc®** on the SSR is also available: please contact us.

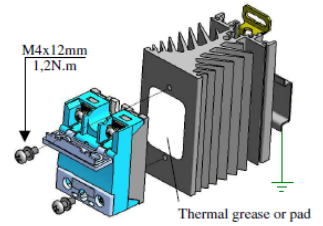

WF151200
(2-2,5 K/W)



WF108110
(1,1 K/W)

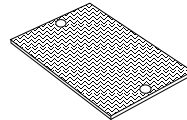

Thermal pad :
5TH21000

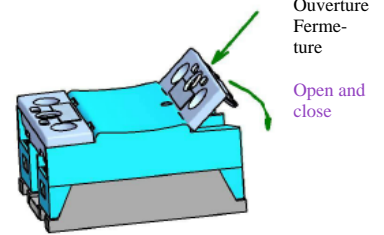

Volets IP20
/ IP20 flaps

Applications

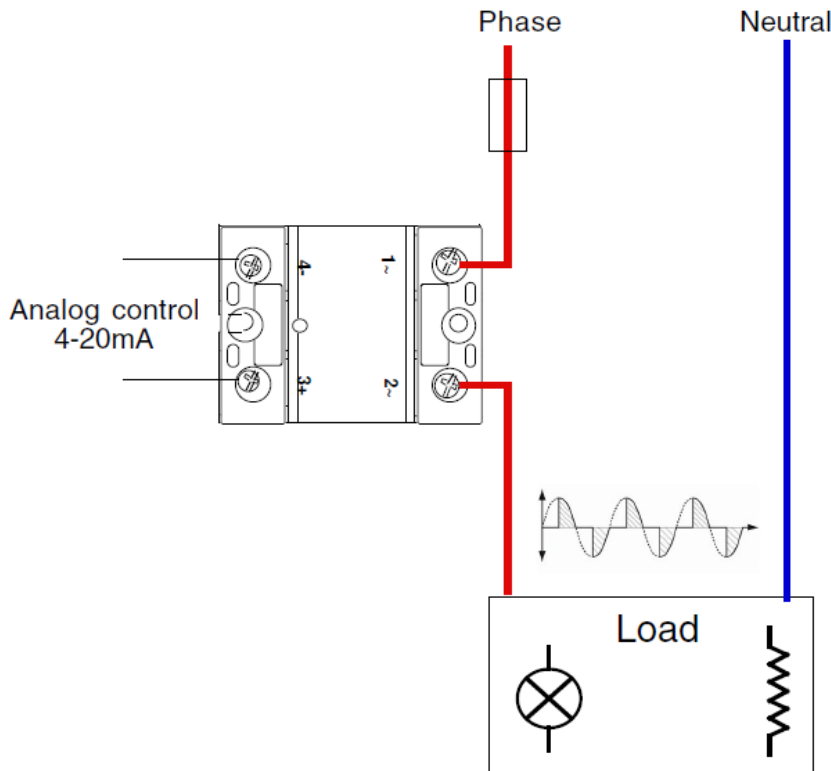

X-ON Electronics

Largest Supplier of Electrical and Electronic Components

Click to view similar products for [Solid State Relays - PCB Mount](#) category:

Click to view products by [Celduc](#) manufacturer:

Other Similar products are found below :

[M86F-2W](#) [M90F-2Y](#) [G2-1A07-ST](#) [G2-1A07-TT](#) [G2-1B02-TT](#) [G2-DA06-ST](#) [923812OCAS](#) [PLA134S](#) [DS11-1005](#) [AQV210EHJ](#) [AQV212J](#)
[AQV252GAJ](#) [AQY210ST](#) [AQY221N2SJ](#) [AQY221R2SJ](#) [AQY410SXJ](#) [AQY412EHAJ](#) [EFR1200480A150](#) [901-7](#) [LCA220](#) [LCB110S](#)
[1618400-5](#) [SR75-1ST](#) [AQH2213AJ](#) [AQV112KLJ](#) [AQV212AJ](#) [AQV212SXJ](#) [AQV238AD01](#) [AQW414TS](#) [AQY221N2SYD01](#)
[AQY221N2V1YJ](#) [AQY221N3VJ](#) [AQY221R2VJ](#) [AQY275AXJ](#) [AQY414SXE01](#) [G2-1A02-ST](#) [G2-1A03-ST](#) [G2-1A03-TT](#) [G2-1A05-ST](#) [G2-](#)
[1A06-TT](#) [G2-1A23-TT](#) [G2-1B01-ST](#) [G2-1B01-TT](#) [G2-1B02-ST](#) [G2-DA03-ST](#) [G2-DA03-TT](#) [G2-DA06-TT](#) [CPC1333GR](#) [3-1617776-2](#)
[CTA2425](#)