

## *MOSFET BASED DC SOLID-STATE RELAY*

- ▶ Latest MOSFET technology generation.
- ▶ Ultra low on-state resistance.
- ▶ Low output leakage current.
- ▶ Low control current consumption.
- ▶ Built-in overvoltage protection
- ▶ Reverse protected triggered control input to avoid linear control risks
- ▶ No radiated or conducted disturbances
- ▶ Touch protected housing IP20



### SOM040100



Control voltage range	3.5-32VDC
Max. permanent output voltage	60VDC
Max. load current with heatsink	40ADC

Load voltage range	Load current range	Control input voltage range	In & case / Out Insulation	Connections	Dimensions (WxHxD)	Weight
5-60VDC	Up to 40A (with heatsink)	3.5-32VDC	2.5kV	Screw terminals	45 x 58.5 x 30	80g

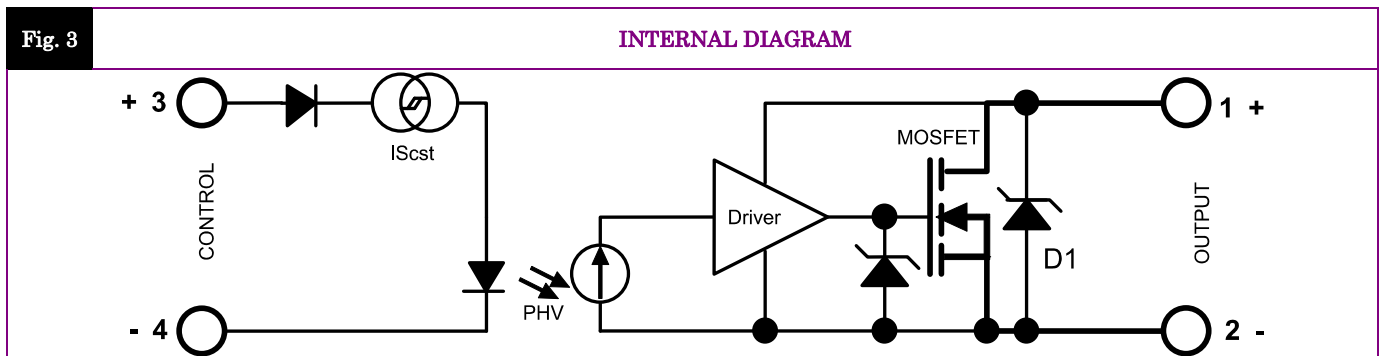
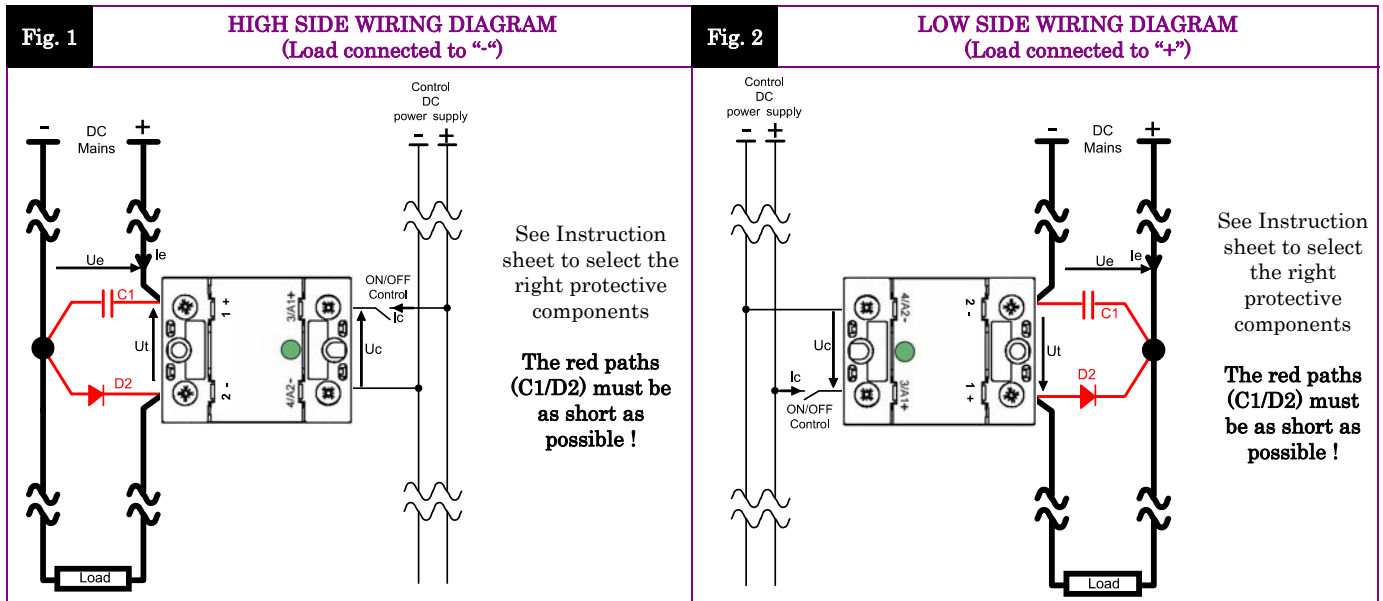

*Proud to serve you*

**CONTROL INPUT CHARACTERISTICS**

INPUT CIRCUIT	CHARACTERISTIC	LABEL	VALUE	INFO.
	Nom. Control voltage	<b>Ucnom</b>	12-24VDC	
	Min. Control current	<b>Icmin</b>	35mADC	-100µA/°C
	Control voltage range	<b>Uc</b>	3.5 – 32VDC	typical ON=3.3V
	Control current consumption	<b>Ic</b>	32 – 35mADC (for control voltage range)	<b>See fig. 5</b>
	Releasing control voltage	<b>Ucoffmax</b>	1VDC	typical OFF= 2.6V
	Max. reverse control voltage	<b>-Ucmax</b>	32VDC	-Icmax<100µA
	Input impedance	<b>Rin</b>	Current limitation	<b>See fig. 5</b>

**POWER OUTPUT CHARACTERISTICS**

POWER CIRCUIT	CHARACTERISTIC	LABEL	VALUE	INFO.
	Nominal voltage	<b>Uenom</b>	<b>48VDC</b>	
	Voltage range	<b>Ut</b>   <b>Ue</b>	<b>5-60VDC</b>	
	Non-repetitive peak voltage	<b>Utp</b>	100V	
	Overvoltage protection	<b>D1</b>	Transient voltage suppressor 56V (1500W/1ms)	
	Max reverse voltage drop (internal diode at OFF state)	<b>-Ut</b>	1.3V	@Ie=80A @Uc=0
	Maximum nominal currents	<b>Ie max</b>	<b>Resistive</b> 40A	<b>Motor</b> Please contact us
	Non-repetitive peak overload current	<b>Id max</b>	320A	<b>See fig. 8</b>
	Min. load current	<b>Iemin</b>	5mA	
	Max. leakage current	<b>Ielk max</b>	3mA	@Utmax @Tjmax
	Max. on-state resistance	<b>RDson</b>	30mOhms	@Iemax @Tjmax
	Typ. output capacitance	<b>Cout</b>	0.7nF	
	Junction/case thermal resistance per power element	<b>Rthjc</b>	0.9K/W	
	Built-in heatsink thermal resistance vertically mounted	<b>Rthra</b>	10K/W	@ΔTra=75°C
	Heatsink thermal time constant	<b>Tthra</b>	10 minutes	@ΔTra=75°C
	Control inputs/power outputs insulation voltage	<b>Uimp</b>	2.5kV	
	Inputs/case insulation voltage	<b>Uimp</b>	2.5kV	
	Outputs/case insulation voltage	<b>Uimp</b>	2.5kV	
	Isolation resistance	<b>Rio</b>	1GΩ	
	Isolation capacitance	<b>Cio</b>	<8pF	
	Maximum junction temperature	<b>Tjmax</b>	175°C	
	Storage ambient temperature	<b>Tstg</b>	-40->+100°C	
	Operating ambient temperature	<b>Tamb</b>	-25->+90°C	<b>See fig. 7</b>
	Max. case temperature	<b>Tc</b>	100°C	

**PROTECTION CHARACTERISTICS**

PROTECTION	Leakage current (Ielk) vs DC voltage (Ut)	Absolute limits
	<p><b>Ielk</b> : Leakage current of the relay  <b>Ie</b> : User load nominal current  <b>Utp</b> : Relay max. non repetitive peak voltage</p>	<p><b>Uto &lt; Utp</b></p> $t_{max} = \frac{0.75}{(Uto - Ut_{max}) \times Ie}$ $P_{(protection)} = 1W_{max}$ $\Rightarrow \frac{(Uto - Ut_{max}) \times Ie \times t}{T} \leq 1$ <p><b>t</b> : Overvoltage duration  <b>T</b> : Time between 2 overvoltage</p>

**TIME CHARACTERISTICS**

Fig. 4

TIME DIAGRAMS

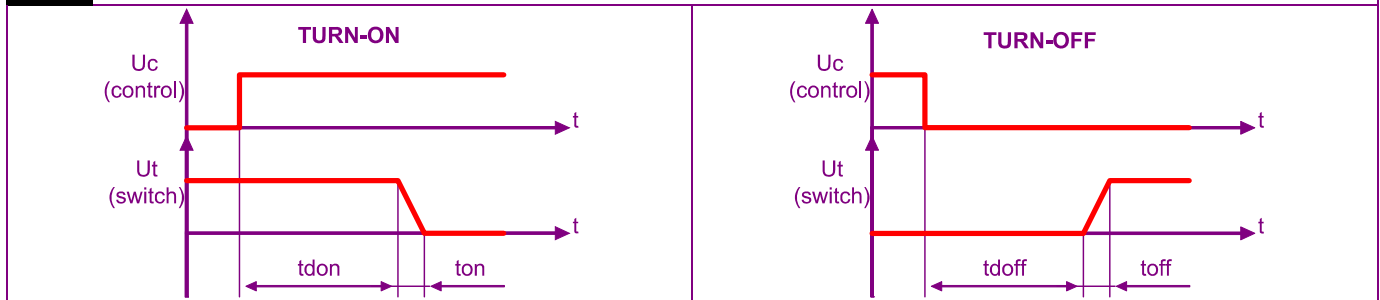

TIME CHARACT.	CHARACTERISTIC	LABEL	VALUE	INFO.
	Turn on time	<b>ton</b>	20µs	
	Turn on delay	<b>tdon</b>	20µs	
	Turn off time	<b>toff</b>	20µs	
	Turn off delay	<b>tdoff</b>	20µs	
Max. On-Off frequency	<b>F<sub>(on-off)</sub></b>	>1000Hz (for high frequency, take 2 x Ie to calculate the heatsink; the protections must be chosen carefully)	Refer to the instruction sheet	

**GENERAL INFORMATION**

CONNECT IONS	Connections	Power	Control	
	Screwdriver advised	POZIDRIV2		
	Min and max tightening torque	2 N.m	1.2 N.m	
	Insulated crimp terminals (round tabs, eyelet type)	M5	M4	

MISC.	Display	Green LED (indicates relay has switched ON)		
	Housing	UL94V0		
	Mounting	2 screws (M4x12mm ; tightening = 1.2N.m)		See mounting sheet
	Noise level	None		
	Weight	80g		

**STANDARDS**

GENERAL	Standards	IEC60947-1		
	Protection level	IP20		
	Protection against direct touch	Yes		
	CE marking	Yes		
	UL, cULUS	Yes		

E.M.C. IMMUNITY	TYPE OF TEST	STANDARD	LEVEL	EFFECT
	Fast transients bursts	EN61000-4-4	4kV criterion B	
	Electric chocks	EN61000-4-5	1kV criterion B	
	Voltage drop	EN61000-4-11	-	

**CHARACTERISTIC CURVES**

**Fig. 5** INPUT CHARACTERISTIC

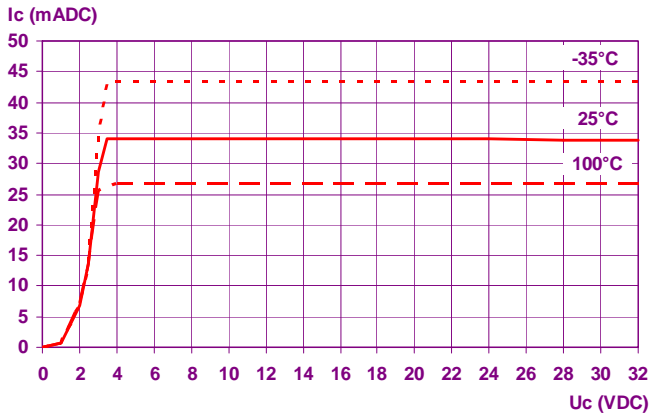

**Fig. 6** ON RESISTANCE VS JUNCTION TEMPERATURE

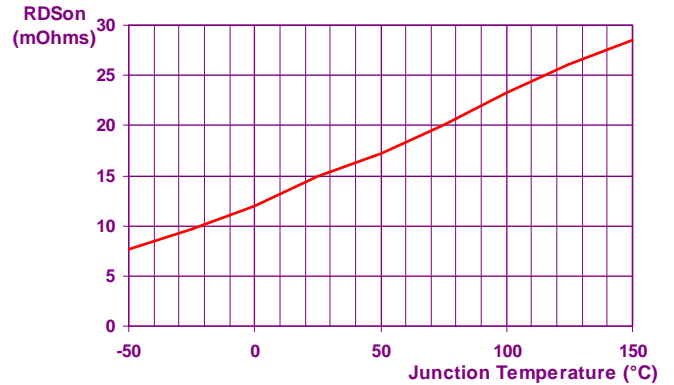

**Fig. 7** POWER DISSIPATED AND LOAD CURRENT LIMIT VS TEMPERATURE

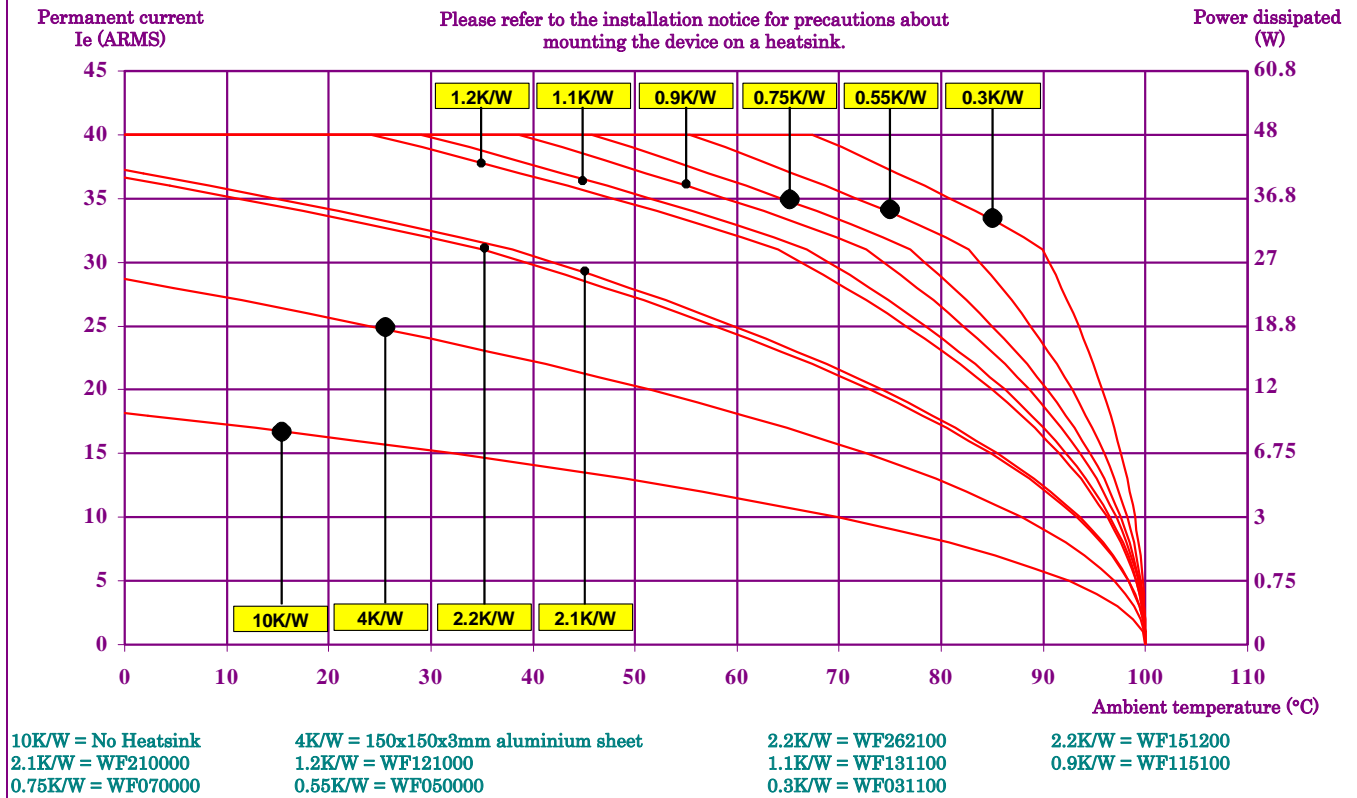

**Fig. 8** PEAK OVERLOAD CURRENT vs. PULSE DURATION CHARACTERISTIC

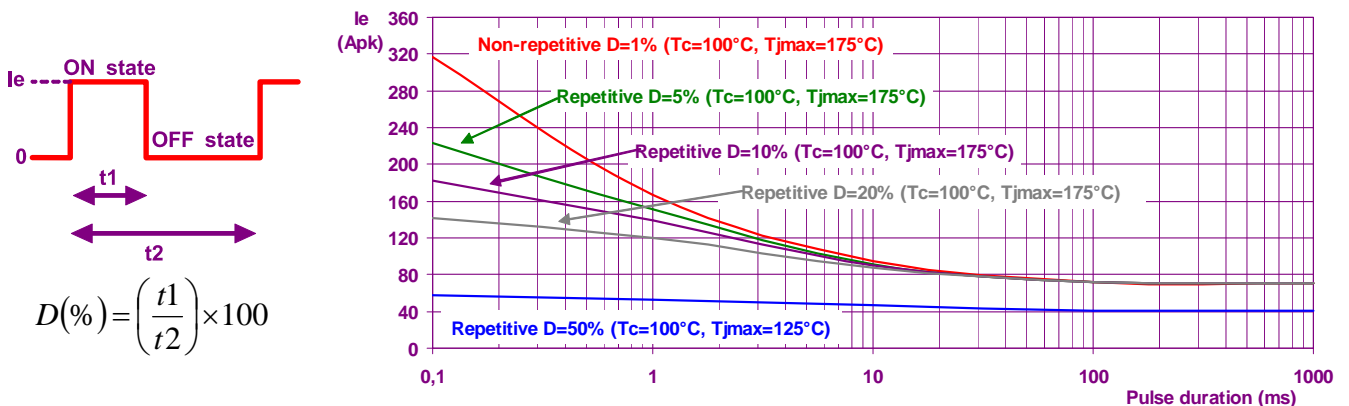

**DIMENSIONS AND ACCESSORIES**

Fig. 9

DIMENSIONS (mm)

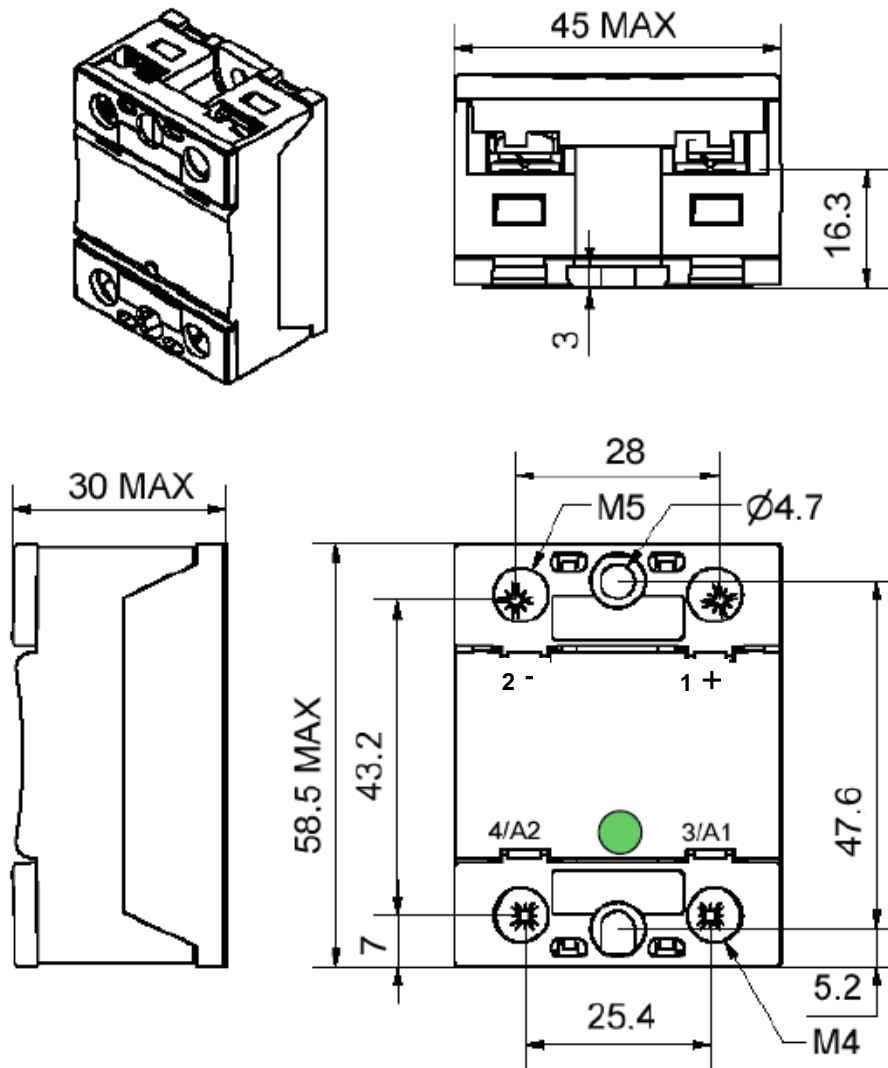

Fig. 10

ACCESSORIES

FASTON : Please contact us



## **X-ON Electronics**

Largest Supplier of Electrical and Electronic Components

*Click to view similar products for [Celduc manufacturer](#):*

Other Similar products are found below :

[2YB20051](#) [2YB20111](#) [D31A3100](#) [D31A5100](#) [D31A7110](#) [D32A3100](#) [D32A5100](#) [D71A2100](#) [ESD05000](#) [PAA10060](#) [PHA01200](#) [PLA10160](#)  
[PLA13750](#) [PSA60010](#) [PSL40010](#) [PTA10440](#) [PTA10490](#) [PTA50010](#) [PTFA0100](#) [PTFA3115](#) [PTI40020](#) [PTPA0230](#) [PW520000](#) [PWB01501](#)  
[SA842070](#) [SA942460](#) [SAL961360](#) [SC842110](#) [SC869110](#) [SCF42324](#) [SCF62160](#) [SCM0100200](#) [SCM030200](#) [SF541310](#) [SF542310](#)  
[SF546310](#) [SGT8658500](#) [SGT8658502](#) [SGT8670500](#) [SGT8678500](#) [SGT8850200](#) [SGT965360E](#) [SGT9854300](#) [SILD867170](#) [SIT867570](#)  
[SKA10420](#) [SKA20421](#) [SKA20440](#) [SKA20441](#) [SKB10440](#)