



产品承认书

SPECIFICATION FOR APPROVED

客户 : **2376**

Customer : _____

客户料号 : _____

Customer P/N : _____

品名 : **SMD POWER INDUCTOR**

Description : _____

产品型号 : **CKCS6020-2.2uH/N**

Center P/N : _____

图纸编号 : **SP-CK112-00059589**

Drawing No. : _____

版本 : **A0**

Rev. No. : _____

出图 DRAWING		
制图 Prepared By	审核 Checked By	批准 Approved By
陈凌宏	马爱善	万芳中
DATE: 2024/1/18		

客户承认 CUSTOMER APPROVAL
DATE: _____



岑科科技(深圳)集团有限公司

SHENZHEN CENKER TECHNOLOGY GROUP CO., LTD.

地址:深圳市龙华区大浪街道恒大时尚慧谷6栋A区11楼

Address:Floor 11,Building 6A,Evergrande Shishang
Huigu Building,Longhua District,Shenzhen

TEL:0755-89808755 FAX:0755-27525256

SPECIFICATION FOR APPROVAL

Cenker P/N	CKCS6020-2.2uH/N	Drawing No.	SP-CK112-00059589	Page	1/5
------------	------------------	-------------	-------------------	------	-----

1、 DIMENSION (mm)

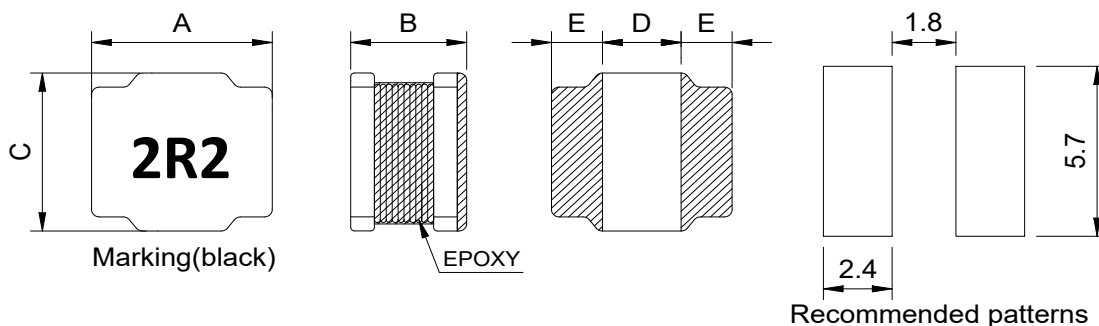

A	B	C	D	E
6.0±0.3	2.1 Max.	6.0±0.3	2.3±0.3	1.85±0.3

2、 SCHEMATIC

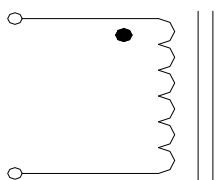

3、 PRODUCT IDENTIFICATION

CKCS	6020	2.2uH	N
①	②	③	④

- ① Series Name
- ② External Dimensions
- ③ Nominal Inductance
- ④ Inductance Tolerance

4、 TEMPERATURE RATING

Operating Temperature : -40°C ~ +125°C (Including self - temperature rise)
 Storage Temperature : -40°C ~ +125°C

SPECIFICATION FOR APPROVAL

Center P/N

CKCS6020-2.2uH/N

Drawing No.

SP-CK112-00059589

Page 2/5

5. ELECTRICAL REQUIREMENTS

ITEM	SPEC.	TEST CONDITION	TEST EQUIPMENT
INDUCTANCE	2.2uH ±30%	100kHz/1V	ZX1378+ZX1378S
DCR	28mΩ ±30%	at 25°C	ZX5512B
Isat	3.75A L0A*70% Ref.	100kHz/1V	ZX1378+ZX1378S
Irms	2.75A Max.	$\Delta T \leq 40^\circ\text{C}$	ZX1378+ZX1378S+ TES1316

Isat: DC current at which the inductance drops approximate 30% from its value without current;

Irms: DC current that causes the temperature rise ($\Delta T \leq 40^\circ\text{C}$) from 25°C ambient.

6. MATERIAL LIST

No.	Material	Specification
1	Core	Ferrite
2	Wire	Copper Wire
3	Solder	Sn
4	Glue	Epoxy
5	Marking	Ink

SPECIFICATION FOR APPROVAL

Cenker P/N	CKCS6020-2.2uH/N	Drawing No.	SP-CK112-00059589	Page	3/5
------------	------------------	-------------	-------------------	------	-----

7、TEST DATA

No	ELECTRONICAL TEST DATA				DIMENSION				
	INDUCTANCE	DCR	L(uH) DC 3.75A		A	B	C	D	E
	2.2uH ±30%	28mΩ ±30%	L0A*70% Ref.		6.0±0.3	2.1 Max.	6.0±0.3	2.3±0.3	1.85±0.3
1	2.21	30.52	1.89		6.04	1.97	6.04	2.29	1.87
2	2.05	31.30	1.75		6.09	1.98	6.03	2.33	1.88
3	2.23	31.20	1.91		6.07	2.00	6.07	2.35	1.86
4	2.18	31.00	1.86		6.10	1.96	6.04	2.32	1.89
5	2.15	32.00	1.84		6.04	1.99	6.03	2.34	1.85
6	2.14	30.70	1.83		6.10	1.98	6.01	2.37	1.87
7	2.19	31.60	1.87		6.09	1.97	6.07	2.31	1.89
8	2.17	32.00	1.86		6.07	2.01	6.02	2.35	1.86
9	2.13	30.40	1.82		6.06	1.94	6.05	2.36	1.85
10	2.22	31.80	1.90		6.09	1.95	6.05	2.36	1.87
X	2.17	31.25	1.85		6.08	1.98	6.04	2.34	1.87
R	0.18	1.60	0.15		0.06	0.07	0.06	0.08	0.04

All judge

OK NG

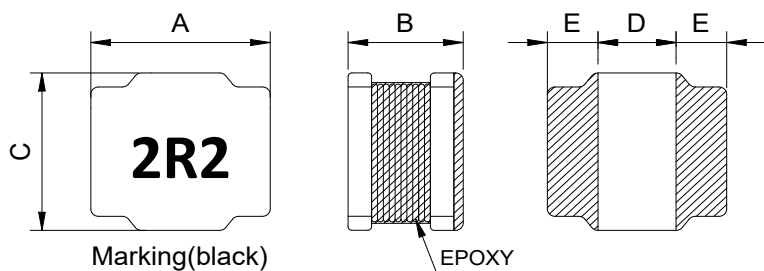

SPECIFICATION FOR APPROVAL

Cenker P/N

CKCS6020-2.2uH/N

Drawing No.

SP-CK112-00059589

Page 4/5

8、PACKAGE

(1) Packaging -Cover Tape

The force for tearing off cover tape is 10 to 130 grams in the arrow direction.

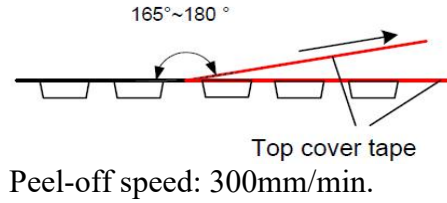
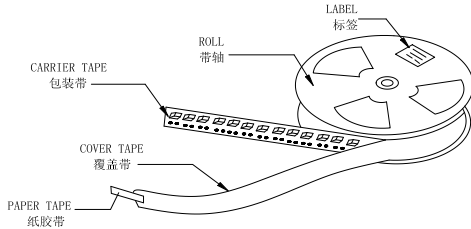

(2) Reel Dimensions (Unit:mm)

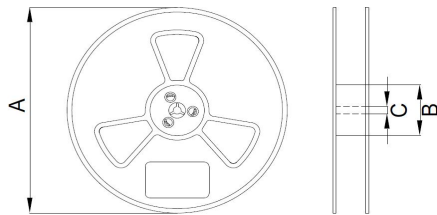

Item	Dimension
A	330±1
B	100±1
C	13±0.5

(3) Tape Dimensions(Unit:mm)

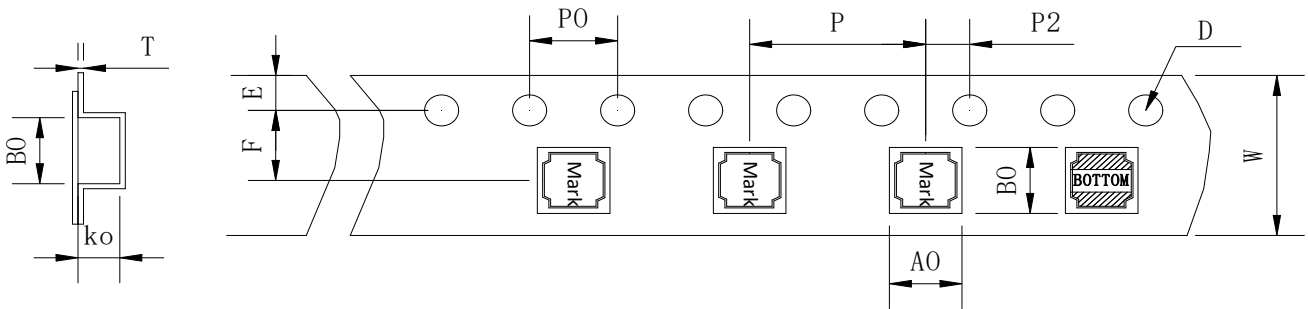

Part No.	W	A0	B0	K0	D	F	E	P	P0	P2	T
CKCS6020	16.0 ±0.3	6.4 ±0.1	6.4 ±0.1	2.2 ±0.1	1.5 ±0.1	7.5 ±0.1	1.75 ±0.1	8.0 ±0.15	4.0 ±0.1	2.0 ±0.1	0.35 ±0.05

(4) Packaging Quantity

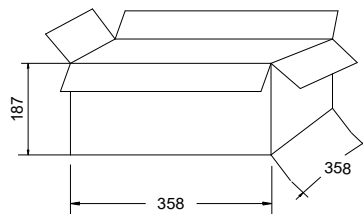
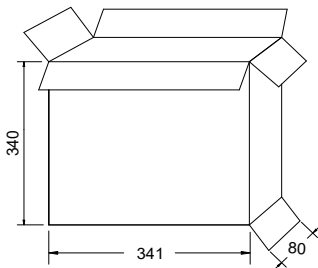

Quantity (Pcs)		
Reel	Box	Carton
2500	7500	15000
1Reel	3Reel/Box	2Box/Carton

SPECIFICATION FOR APPROVAL

Cenker P/N

CKCS6020-2.2uH/N

Drawing No.

SP-CK112-00059589

Page 5/5

9、REFLOW SOLDERING

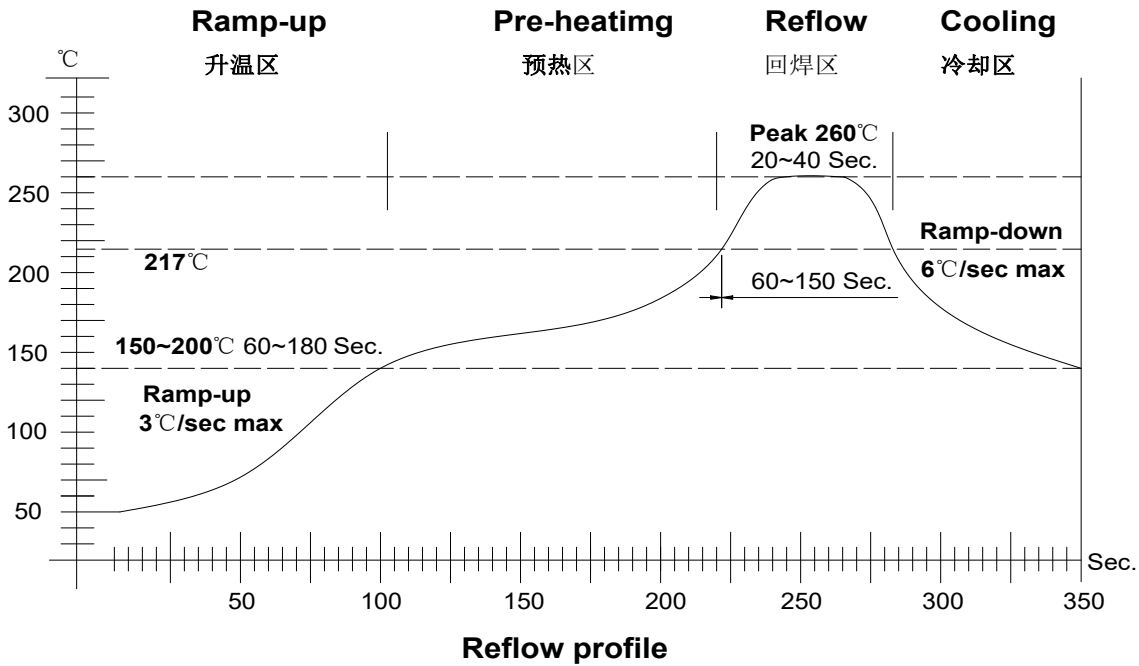

10、IRON SOLDERING

- (1) Iron soldering power: Max.30W
- (2) Pre-heating: 150°C,1 Minute
- (3) Soldering Tip temperature: 350°C Max.
- (4) Soldering time: 3sec Max.

11、MSL等级: MSL, level 1



使用注意事项 Matters needing attention



1. 在设计PCB时, 请考虑非磁屏蔽元器件的安装位置,避免磁干扰引起的故障.
1. When designing the PCB, please consider the installation position of the non-magnetic shielded components to avoid failures caused by magnetic interference.
2. 请勿将本产品靠近磁铁或带有磁力的物体.
2. Do not place this product near magnets or objects with magnetic force.
3. 请勿将产品保存在高温、高湿、有灰尘、腐蚀环境（盐、酸、碱等）等不适合环境中.
3. Do not store the product in unsuitable environments such as high temperature, high humidity, dusty, corrosive environments (salt, acid, alkali, etc.).
4. 产品会因通电而自我发热（温度上升），在热设计方面需留有充分余量.
4. The product will self-heat (temperature rise) due to power-on, and sufficient margin should be left in thermal design.
5. 由于人体所带的静电会传到接地线上，因此请使用防静电腕带.
5. Since the static electricity carried by the human body will be transmitted to the ground wire, please use an anti-static wrist strap.
6. 人体手上有油脂可能导致可焊性下降. 请避免手直接接触端子.
6. Grease on human hands may lead to decreased solderability. Please avoid direct contact with the terminals.
7. 端子过度弯曲会导致断线,请不要过度弯曲端子.
7. Excessive bending of the terminal will lead to disconnection, please do not bend the terminal excessively.
8. 产品对直接冲击很敏感, 冲击可能导致产品磁芯损伤及破损.
8. The product is very sensitive to direct impact, the impact may cause damage and breakage of the product's magnetic core.
9. 在客户使用时, 如果产品被灌封或胶固定, 必须注意:
9. When the customer uses, if the product is potted or glued, it must be noted:
 - 大部分灌封材料在硬化时都会收缩, 因此对塑胶骨架或磁芯有施加应力, 这种应力作用可以给电气特性带来负面影响,极端情况下可能损坏磁芯或塑胶骨架的机械性能.
 - Most potting materials will shrink when hardened, so there is a stress on the plastic skeleton or magnetic core, This stress action can negatively affect the electrical properties and in extreme cases can damage the mechanical properties of the magnetic core or plastic skeleton.
 - 必须检查使用灌封材料是否会导致漆包线的绝缘层,塑胶骨架或胶水的性能降低甚至损坏.
 - It must be checked whether the use of potting materials will cause the insulation layer of the enameled wire, the performance of the plastic skeleton or the glue to be degraded or even damaged.
 - 灌封材料的影响可以改变磁性元器件的高频特性.
 - The effect of potting material can change the high frequency characteristics of magnetic components.



使用注意事项 Matters needing attention



10. 对于合金或非涂层产品,如果将产品长期放置在潮湿的环境中,产品的表面可能会生锈,但不会影响产品的特性.
10. For alloy or non-coated products, if the product is placed in a humid environment for a long time, the surface of the product may rust, But it will not affect the characteristics of the product.
11. 本产品是指在通用标准上用于影音娱乐,家电,计算机,办公自动化,通讯,电源模块,LED照明,测量设备,机械工具,工业控制板等一般电子设备中. 并且该一般电子设备要在通常的操作和使用方法下使用.
11. This product refers to the general standard used in audio-visual entertainment, home appliances, computers, office automation, communications, power modules, LED lighting, measuring equipment, Machine tools, industrial control panels and other general electronic equipment. And the general electronic equipment should be used under the usual operation and usage methods.
12. 当本产品使用在一般电子设备以外的场合,如:车载,交通工具控制设备,医疗设备,军用设备,航空航天设备,海底设备等,请务必联系本公司销售部门,本公司会配合客户需求,一起协商不同于本产品中所记载的使用用途.
12. When this product is used in occasions other than general electronic equipment, such as: Automotive Electronic products, medical equipment, military equipment, Aerospace equipment, submarine equipment, etc., please be sure to contact the company's sales department, the company will cooperate with customer needs, and negotiate different intended use described in this product.
13. 保存时间为 12 个月以内, 保存条件: 温度 -10 ~ 40°C、湿度 70%RH 以下,需充分注意,若超过保存时间,端子电极的可焊性将可能变差.
13. Storage time is within 12 months, storage conditions: temperature -10 ~ 40°C, humidity 70%RH Max. It should be fully noted that if the storage time is exceeded, the solderability of the terminal electrodes may deteriorate.

X-ON Electronics

Largest Supplier of Electrical and Electronic Components

Click to view similar products for [Fixed Inductors](#) category:

Click to view products by [CENKER](#) manufacturer:

Other Similar products are found below :

[CR32NP-100KC](#) [CR54NP-470LC](#) [70F224AI](#) [MGDQ4-00004-P](#) [MHQ1005P10NJ](#) [MHQ1005P1N0S](#) [MHQ1005P2N4S](#) [MHQ1005P3N6S](#)
[MHQ1005P5N1S](#) [MHQ1005P8N2J](#) [PE-53601NL](#) [PE-53602NL](#) [PG0936.113NLT](#) [9220-20](#) [9310-16](#) [PM06-2N7](#) [PM06-39NJ](#) [A01TK](#)
[1206CS-471XJ](#) [HC2-R47-R](#) [HC8-1R2-R](#) [HCF1305-3R3-R](#) [1206CS-151XG](#) [RCH664NP-140L](#) [RCH664NP-4R7M](#) [RCP1317NP-391L](#)
[RCR110DNP-331L](#) [DH2280-4R7M](#) [DS1608C-106](#) [B10TJ](#) [B82498B3101J000](#) [ELJ-RE27NJF2](#) [1812CS-153XJ](#) [1812CS-183XJ](#) [1812CS-](#)
[223XJ](#) [1812LS-104XJ](#) [1812LS-105XJ](#) [1812LS-124XJ](#) [1812LS-154XJ](#) [1812LS-223XJ](#) [1812LS-224XJ](#) [1812LS-563XJ](#) [1812LS-683XJ](#)
[1812LS-824XJ](#) [NIN-FB101JTR110F](#) [NIN-FB471JTR62F](#) [NIN-FC1R5JTR220F](#) [NIN-HCR15JTRF](#) [NIN-HCR33JTRF](#) [NIN-HDR22JTRF](#)