



● **FEATURES 特性**

1.表面贴装,小型、超薄电感器,大功率,高饱和,低电阻之特性.

The inductor designed as surface mounting, smallest and thinnest with high power, high saturation and low resistance

2.磁性胶水涂敷结构极大减少了噪声,闭合磁路结构设计,漏磁少,抗EMI能力强.

Magnetic-resin shielded structure reduces buzz noise to ultra-low levels, Closed magnetic circuit structure reduces magnetic leakage flux, high performance of anti-EMI.

3.同等尺寸额定电流较传统电感高出30%以上.

Compared with the same size part, the rated current 30% higher than the traditional inductors.

4.工作频率范围广,可达5MHz以上. Wide range working frequency that reach more than 5MHz

5.RoHS, 无卤环保产品. RoHS, Halogen-free environmental protection products

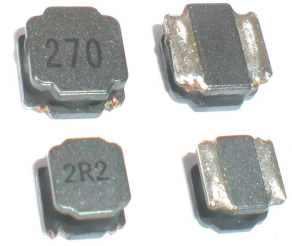

● **APPLICATIONS 用途**

1. LED Lighting LED 照明

2. Automotive systems 汽车产品

3. Notebooks,desktop computers,servers,graphic cards 笔记本电脑,台式电脑,服务器,显卡

● **PART NUMBERING SYSTEM 品名系统**

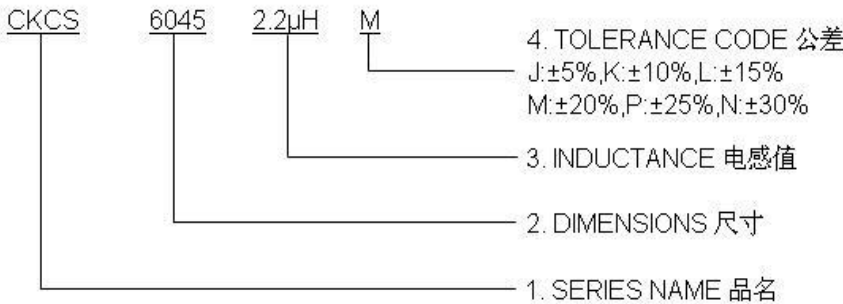

● **STRUCTURAL DRAWING 结构图**

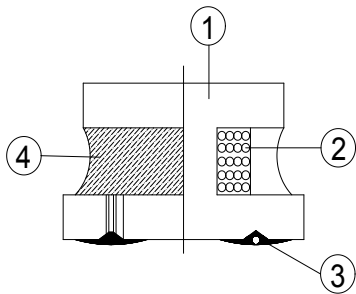

- ① Freeite core Ni-Zn Ferrite
- ② Winding wire Polyurethane-copper wire
- ③ Electrode External electrode
- ④ Epoxy resin containing ferrite powder



● SHAPES AND DIMENSIONS 外形尺寸 (Unit:mm)

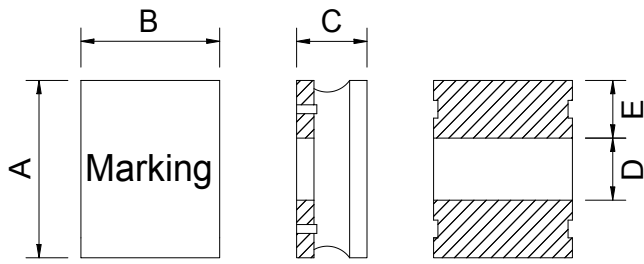

Fig 1

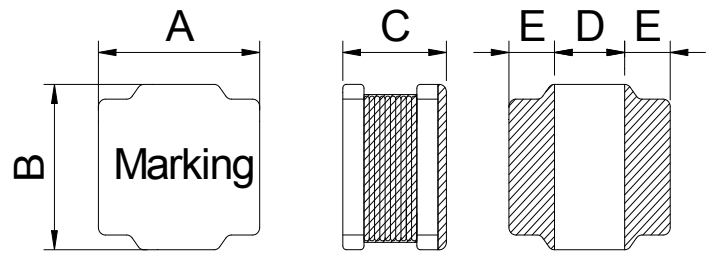

Fig 2

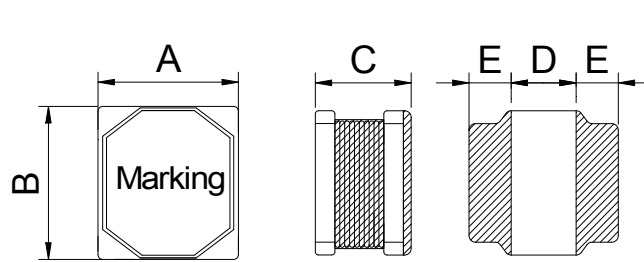
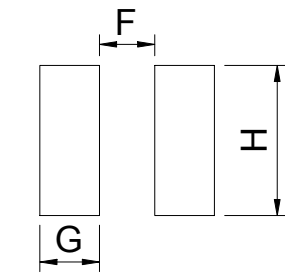

Fig 3



Recommended patterns

| TYPE(型号) | A | B | C | D | E | F | G | H | Fig |
|------------|---------|---------|----------|---------|----------|-----|------|-----|-----|
| CKCS201610 | 2.0±0.3 | 1.6±0.3 | 1.05 Max | 0.6±0.2 | 0.77±0.2 | 0.6 | 0.8 | 1.8 | 1 |
| CKCS252010 | 2.5±0.3 | 2.0±0.3 | 1.05 Max | 0.8±0.3 | 0.9±0.3 | 0.6 | 1.1 | 2.0 | 1 |
| CKCS252012 | 2.5±0.3 | 2.0±0.3 | 1.25 Max | 0.8±0.3 | 0.9±0.3 | 0.6 | 1.1 | 2.0 | 1 |
| CKCS3010 | 3.0±0.2 | 3.0±0.2 | 1.1 Max | 1.2±0.3 | 0.9±0.3 | 1.1 | 1.0 | 2.7 | 3 |
| CKCS3012 | 3.0±0.2 | 3.0±0.2 | 1.3 Max | 1.2±0.3 | 0.9±0.3 | 1.1 | 1.0 | 2.7 | 3 |
| CKCS3015 | 3.0±0.2 | 3.0±0.2 | 1.7 Max | 1.2±0.3 | 0.9±0.3 | 1.1 | 1.0 | 2.7 | 3 |
| CKCS4012 | 4.0±0.2 | 4.0±0.2 | 1.2 Max | 1.6±0.3 | 1.2±0.3 | 1.4 | 1.3 | 3.7 | 3 |
| CKCS4018 | 4.0±0.2 | 4.0±0.2 | 1.8 Max | 1.6±0.3 | 1.2±0.3 | 1.4 | 1.3 | 3.7 | 3 |
| CKCS4020 | 4.0±0.2 | 4.0±0.2 | 2.0 Max | 1.6±0.3 | 1.2±0.3 | 1.4 | 1.3 | 3.7 | 3 |
| CKCS4030 | 4.0±0.2 | 4.0±0.2 | 3.0 Max | 1.3±0.3 | 1.35±0.3 | 1.2 | 1.40 | 3.7 | 3 |
| CKCS5020 | 5.0±0.2 | 5.0±0.2 | 2.1 Max | 1.4±0.3 | 1.8±0.3 | 1.2 | 1.9 | 4.2 | 2 |
| CKCS5040 | 5.0±0.2 | 5.0±0.2 | 4.0 Max | 1.6±0.3 | 1.7±0.3 | 1.4 | 1.8 | 4.2 | 3 |
| CKCS6020 | 6.0±0.3 | 6.0±0.3 | 2.1 Max | 2.3±0.3 | 1.85±0.3 | 2.4 | 1.8 | 5.7 | 2 |
| CKCS6028 | 6.0±0.3 | 6.0±0.3 | 3.0 Max | 2.3±0.3 | 1.85±0.3 | 2.4 | 1.8 | 5.7 | 2 |
| CKCS6045 | 6.0±0.3 | 6.0±0.3 | 4.7 Max | 2.3±0.3 | 1.85±0.3 | 2.4 | 1.8 | 5.7 | 2 |
| CKCS8040 | 8.0±0.3 | 8.0±0.3 | 4.2 Max | 3.8±0.3 | 2.1±0.3 | 3.6 | 2.2 | 7.5 | 2 |



● SPECIFICATION TABLE:

| PART NUMBER 品名 | INDUCTANCE (μ H) 电感值 | DCR (Max.) (Ω) 直流电阻 | Isat (Max.) (A) 饱和电流 | Irms (Max.) (A) 额定电流 | Marker 印字 |
|---------------------|---------------------------------|------------------------------------|----------------------------|----------------------------|--------------|
| CKCS201610-0.47uH/N | 0.47 \pm 30% | 0.059 | 2.30 | 2.35 | / |
| CKCS201610-0.68uH/N | 0.68 \pm 30% | 0.076 | 1.95 | 2.05 | / |
| CKCS201610-1uH/N | 1.0 \pm 30% | 0.114 | 1.65 | 1.45 | / |
| CKCS201610-1.5uH/N | 1.5 \pm 30% | 0.174 | 1.35 | 1.25 | / |
| CKCS201610-2.2uH/M | 2.2 \pm 20% | 0.264 | 1.20 | 1.10 | / |
| CKCS201610-3.3uH/M | 3.3 \pm 20% | 0.335 | 0.90 | 0.88 | / |
| CKCS201610-4.7uH/M | 4.7 \pm 20% | 0.479 | 0.70 | 0.74 | / |
| CKCS201610-6.8uH/M | 6.8 \pm 20% | 0.816 | 0.60 | 0.52 | / |
| CKCS201610-10uH/M | 10 \pm 20% | 1.020 | 0.50 | 0.45 | / |

| PART NUMBER 品名 | INDUCTANCE (μ H) 电感值 | DCR (Max.) (Ω) 直流电阻 | Isat (Max.) (A) 饱和电流 | Irms (Max.) (A) 额定电流 | Marker 印字 |
|--------------------|---------------------------------|------------------------------------|----------------------------|----------------------------|--------------|
| CKCS252010-1.0uH/N | 1.0 \pm 30% | 0.108 | 1.85 | 1.65 | A |
| CKCS252010-1.5uH/N | 1.5 \pm 30% | 0.182 | 1.80 | 1.30 | B |
| CKCS252010-2.2uH/N | 2.2 \pm 30% | 0.209 | 1.20 | 1.20 | C |
| CKCS252010-3.3uH/M | 3.3 \pm 20% | 0.328 | 1.05 | 0.90 | D |
| CKCS252010-4.7uH/N | 4.7 \pm 20% | 0.563 | 0.95 | 0.70 | E |
| CKCS252010-5.6uH/M | 5.6 \pm 20% | 0.563 | 0.80 | 0.73 | F |
| CKCS252010-6.8uH/M | 6.8 \pm 20% | 0.896 | 0.78 | 0.59 | G |
| CKCS252010-10uH/M | 10 \pm 20% | 1.092 | 0.65 | 0.50 | H |
| CKCS252010-15uH/M | 15 \pm 20% | 1.885 | 0.46 | 0.36 | I |
| CKCS252010-22uH/M | 22 \pm 20% | 2.400 | 0.45 | 0.30 | J |

Remark: 1. Inductance Tested at 1MHz, 0.25Vrms (20 $^{\circ}$ C)

2. Isat: DC current at which the inductance drops approximate 30% from its value without current;
3. Irms: DC current that causes the temperature rise ($\Delta T = 40^{\circ}C$) from 25 $^{\circ}C$ ambient.
4. Operating Temperature : -25 $^{\circ}C$ ~ +125 $^{\circ}C$



● SPECIFICATION TABLE:

| PART NUMBER 品名 | INDUCTANCE (μ H) 电感值 | DCR (Max.) (Ω) 直流电阻 | Isat (Max.) (A) 饱和电流 | Irms (Max.) (A) 额定电流 | Marker 印字 |
|---------------------|---------------------------------|------------------------------------|----------------------------|----------------------------|--------------|
| CKCS252012-0.47uH/N | 0.47 \pm 30% | 0.061 | 3.82 | 2.15 | A |
| CKCS252012-0.68uH/N | 0.68 \pm 30% | 0.074 | 3.28 | 1.95 | B |
| CKCS252012-1.0uH/N | 1.0 \pm 30% | 0.09 | 2.59 | 1.93 | C |
| CKCS252012-1.2uH/N | 1.2 \pm 30% | 0.129 | 2.38 | 1.46 | D |
| CKCS252012-1.5uH/N | 1.5 \pm 30% | 0.147 | 2.24 | 1.40 | E |
| CKCS252012-2.2uH/N | 2.2 \pm 30% | 0.216 | 1.85 | 1.15 | F |
| CKCS252012-3.3uH/M | 3.3 \pm 20% | 0.264 | 1.61 | 1.04 | G |
| CKCS252012-4.7uH/M | 4.7 \pm 20% | 0.377 | 1.12 | 0.84 | H |
| CKCS252012-5.6uH/M | 5.6 \pm 20% | 0.538 | 1.11 | 0.73 | I |
| CKCS252012-6.8uH/M | 6.8 \pm 20% | 0.581 | 0.98 | 0.69 | J |
| CKCS252012-8.2uH/M | 8.2 \pm 20% | 0.658 | 0.98 | 0.65 | N |
| CKCS252012-10uH/M | 10 \pm 20% | 0.69 | 0.79 | 0.62 | K |
| CKCS252012-12uH/M | 12 \pm 20% | 1.075 | 0.78 | 0.51 | O |
| CKCS252012-15uH/M | 15 \pm 20% | 1.591 | 0.68 | 0.42 | L |
| CKCS252012-22uH/M | 22 \pm 20% | 1.976 | 0.53 | 0.38 | M |

Remark: 1. Inductance Tested at 1MHz, 0.25Vrms (20 $^{\circ}$ C)

2. Isat: DC current at which the inductance drops approximate 30% from its value without current;
3. Irms: DC current that causes the temperature rise ($\Delta T = 40^{\circ}C$) from 25 $^{\circ}$ C ambient.
4. Operating Temperature : -25 $^{\circ}$ C ~ +125 $^{\circ}$ C



● SPECIFICATION TABLE:

| PART NUMBER 品名 | INDUCTANCE (μ H) 电感值 | DCR (\pm 30%) (Ω) 直流电阻 | Isat (Max.) (A) 饱和电流 | Irms (Max.) (A) 额定电流 | S.R.F.(Min.) (MHz) 自谐频率 |
|-------------------|---------------------------------|--|----------------------------|----------------------------|-------------------------------|
| CKCS3010-1.0uH/N | 1.0 \pm 30% | 0.065 | 1.40 | 1.45 | 180 |
| CKCS3010-1.5uH/N | 1.5 \pm 30% | 0.080 | 1.27 | 1.30 | 120 |
| CKCS3010-2.2uH/N | 2.2 \pm 30% | 0.110 | 1.15 | 1.09 | 100 |
| CKCS3010-3.3uH/M | 3.3 \pm 20% | 0.145 | 0.97 | 0.96 | 74 |
| CKCS3010-4.7uH/M | 4.7 \pm 20% | 0.225 | 0.75 | 0.77 | 59 |
| CKCS3010-6.8uH/M | 6.8 \pm 20% | 0.305 | 0.55 | 0.66 | 42 |
| CKCS3010-10uH/M | 10 \pm 20% | 0.400 | 0.55 | 0.58 | 39 |
| CKCS3010-15uH/M | 15 \pm 20% | 0.610 | 0.42 | 0.47 | 30 |
| CKCS3010-22uH/M | 22 \pm 20% | 0.930 | 0.35 | 0.38 | 28 |
| CKCS3010-33uH/M | 33 \pm 20% | 1.550 | 0.29 | 0.30 | 18 |
| CKCS3010-47uH/M | 47 \pm 20% | 1.950 | 0.22 | 0.26 | 18 |

| PART NUMBER 品名 | INDUCTANCE (μ H) 电感值 | DCR (\pm 30%) (Ω) 直流电阻 | Isat (Max.) (A) 饱和电流 | Irms (Max.) (A) 额定电流 | S.R.F.(Min.) (MHz) 自谐频率 |
|-------------------|---------------------------------|--|----------------------------|----------------------------|-------------------------------|
| CKCS3012-1.0uH/N | 1.0 \pm 30% | 0.040 | 1.87 | 2.20 | 120 |
| CKCS3012-1.5uH/N | 1.5 \pm 30% | 0.045 | 1.62 | 2.01 | 110 |
| CKCS3012-2.2uH/N | 2.2 \pm 30% | 0.075 | 1.20 | 1.55 | 84 |
| CKCS3012-3.3uH/M | 3.3 \pm 20% | 0.100 | 1.05 | 1.36 | 64 |
| CKCS3012-4.7uH/M | 4.7 \pm 20% | 0.120 | 0.90 | 1.24 | 61 |
| CKCS3012-6.8uH/M | 6.8 \pm 20% | 0.190 | 0.75 | 0.98 | 61 |
| CKCS3012-10uH/M | 10 \pm 20% | 0.265 | 0.60 | 0.83 | 42 |
| CKCS3012-15uH/M | 15 \pm 20% | 0.360 | 0.45 | 0.71 | 27 |
| CKCS3012-22uH/M | 22 \pm 20% | 0.645 | 0.42 | 0.53 | 23 |
| CKCS3012-33uH/M | 33 \pm 20% | 0.875 | 0.36 | 0.46 | 18 |
| CKCS3012-47uH/M | 47 \pm 20% | 1.450 | 0.27 | 0.35 | 14 |
| CKCS3012-68uH/M | 68 \pm 20% | 1.670 | 0.24 | 0.33 | 12 |

Remark: 1. Inductance Tested at 100kHz, 1Vrms (20 $^{\circ}$ C)

2. Isat: DC current at which the inductance drops approximate 30% from its value without current;
3. Irms: DC current that causes the temperature rise (Δ T =40 $^{\circ}$ C) from 25 $^{\circ}$ C ambient.
4. Operating Temperature : -25 $^{\circ}$ C ~ +125 $^{\circ}$ C



● SPECIFICATION TABLE:

| PART NUMBER 品名 | INDUCTANCE (μ H) 电感值 | DCR (\pm 30%) (Ω) 直流电阻 | Isat (Max.) (A) 饱和电流 | Irms (Max.) (A) 额定电流 | S.R.F.(Min.) (MHz) 自谐频率 |
|-------------------|---------------------------------|--|----------------------------|----------------------------|-------------------------------|
| CKCS3015-1.0uH/N | 1.0 \pm 30% | 0.039 | 2.32 | 2.35 | 150 |
| CKCS3015-1.2uH/N | 1.2 \pm 30% | 0.040 | 2.21 | 1.95 | 110 |
| CKCS3015-1.5uH/N | 1.5 \pm 30% | 0.050 | 2.00 | 1.70 | 100 |
| CKCS3015-1.8uH/N | 1.8 \pm 30% | 0.050 | 1.75 | 1.70 | 92 |
| CKCS3015-2.2uH/N | 2.2 \pm 30% | 0.060 | 1.60 | 1.60 | 86 |
| CKCS3015-3.3uH/M | 3.3 \pm 20% | 0.080 | 1.32 | 1.36 | 68 |
| CKCS3015-4.7uH/M | 4.7 \pm 20% | 0.125 | 1.10 | 1.09 | 46 |
| CKCS3015-6.8uH/M | 6.8 \pm 20% | 0.200 | 0.85 | 0.85 | 39 |
| CKCS3015-10uH/M | 10 \pm 20% | 0.250 | 0.72 | 0.77 | 41 |
| CKCS3015-12uH/M | 12 \pm 20% | 0.320 | 0.70 | 0.68 | 32 |
| CKCS3015-15uH/M | 15 \pm 20% | 0.350 | 0.66 | 0.65 | 30 |
| CKCS3015-18uH/M | 18 \pm 20% | 0.430 | 0.56 | 0.59 | 23 |
| CKCS3015-22uH/M | 22 \pm 20% | 0.460 | 0.52 | 0.57 | 23 |
| CKCS3015-33uH/M | 33 \pm 20% | 0.820 | 0.44 | 0.43 | 20 |
| CKCS3015-47uH/M | 47 \pm 20% | 1.250 | 0.35 | 0.35 | 14 |

Remark: 1. Inductance Tested at 100kHz, 1Vrms (20°C)

2. Isat: DC current at which the inductance drops approximate 30% from its value without current;

3. Irms: DC current that causes the temperature rise ($\Delta T = 40^\circ C$) from 25°C ambient.

4. Operating Temperature : -25°C ~ +125°C



● SPECIFICATION TABLE:

| PART NUMBER 品名 | INDUCTANCE (μ H) 电感值 | DCR (\pm 30%) (Ω) 直流电阻 | Isat (Max.) (A) 饱和电流 | Irms (Max.) (A) 额定电流 | S.R.F.(Min.) (MHz) 自谐频率 |
|-------------------|---------------------------------|--|----------------------------|----------------------------|-------------------------------|
| CKCS4012-0.82uH/N | 0.82 \pm 30% | 0.050 | 3.02 | 1.65 | 150 |
| CKCS4012-1.0uH/N | 1.0 \pm 30% | 0.050 | 2.61 | 1.65 | 120 |
| CKCS4012-1.5uH/N | 1.5 \pm 30% | 0.065 | 2.10 | 1.46 | 90 |
| CKCS4012-1.8uH/N | 1.8 \pm 30% | 0.080 | 2.12 | 1.32 | 88 |
| CKCS4012-2.2uH/N | 2.2 \pm 30% | 0.080 | 1.76 | 1.32 | 74 |
| CKCS4012-3.3uH/N | 3.3 \pm 30% | 0.110 | 1.72 | 1.12 | 60 |
| CKCS4012-4.7uH/N | 4.7 \pm 30% | 0.125 | 1.15 | 1.05 | 50 |
| CKCS4012-6.8uH/M | 6.8 \pm 20% | 0.198 | 0.85 | 0.84 | 40 |
| CKCS4012-10uH/M | 10 \pm 20% | 0.265 | 0.80 | 0.77 | 33 |
| CKCS4012-12uH/M | 12 \pm 20% | 0.290 | 0.66 | 0.70 | 32 |
| CKCS4012-15uH/M | 15 \pm 20% | 0.340 | 0.56 | 0.64 | 25 |
| CKCS4012-22uH/M | 22 \pm 20% | 0.587 | 0.46 | 0.49 | 20 |
| CKCS4012-33uH/M | 33 \pm 20% | 0.810 | 0.42 | 0.42 | 17 |
| CKCS4012-47uH/M | 47 \pm 20% | 1.100 | 0.35 | 0.37 | 12 |
| CKCS4012-68uH/M | 68 \pm 20% | 1.950 | 0.38 | 0.27 | 11 |
| CKCS4012-82uH/M | 82 \pm 20% | 2.140 | 0.28 | 0.26 | 11 |
| CKCS4012-100uH/M | 100 \pm 20% | 2.210 | 0.25 | 0.25 | 9.4 |

Remark: 1. Inductance Tested at 100kHz, 1Vrms (20 $^{\circ}$ C)

2. Isat: DC current at which the inductance drops approximate 30% from its value without current;
3. Irms: DC current that causes the temperature rise (Δ T =40 $^{\circ}$ C) from 25 $^{\circ}$ C ambient.
4. Operating Temperature : -25 $^{\circ}$ C ~ +125 $^{\circ}$ C



● SPECIFICATION TABLE:

| PART NUMBER 品名 | INDUCTANCE (μ H) 电感值 | DCR (\pm 30%) (Ω) 直流电阻 | Isat (Max.) (A) 饱和电流 | Irms (Max.) (A) 额定电流 | S.R.F.(Min.) (MHz) 自谐频率 |
|-------------------|---------------------------------|--|----------------------------|----------------------------|-------------------------------|
| CKCS4018-1.0uH/N | 1.0 \pm 30% | 0.025 | 4.20 | 2.00 | 80 |
| CKCS4018-1.5uH/N | 1.5 \pm 30% | 0.030 | 3.35 | 1.80 | 65 |
| CKCS4018-2.2uH/M | 2.2 \pm 20% | 0.045 | 2.70 | 1.65 | 52 |
| CKCS4018-3.3uH/M | 3.3 \pm 20% | 0.070 | 2.45 | 1.23 | 44 |
| CKCS4018-4.7uH/M | 4.7 \pm 20% | 0.090 | 1.70 | 1.20 | 34 |
| CKCS4018-6.8uH/M | 6.8 \pm 20% | 0.110 | 1.45 | 1.06 | 29 |
| CKCS4018-10uH/M | 10 \pm 20% | 0.180 | 1.30 | 0.84 | 24 |
| CKCS4018-15uH/M | 15 \pm 20% | 0.250 | 0.94 | 0.65 | 19 |
| CKCS4018-22uH/M | 22 \pm 20% | 0.360 | 0.80 | 0.59 | 16 |
| CKCS4018-33uH/M | 33 \pm 20% | 0.530 | 0.56 | 0.49 | 12 |
| CKCS4018-47uH/M | 47 \pm 20% | 0.650 | 0.57 | 0.42 | 10 |
| CKCS4018-68uH/M | 68 \pm 20% | 1.000 | 0.47 | 0.32 | 8.3 |
| CKCS4018-100uH/M | 100 \pm 20% | 1.750 | 0.40 | 0.25 | 6.5 |
| CKCS4018-150uH/M | 150 \pm 20% | 2.500 | 0.31 | 0.22 | 5.5 |
| CKCS4018-220uH/M | 220 \pm 20% | 4.000 | 0.27 | 0.17 | 4.0 |
| CKCS4018-330uH/M | 330 \pm 20% | 6.500 | 0.20 | 0.14 | 2.2 |

Remark: 1. Inductance Tested at 100kHz, 1Vrms (20 $^{\circ}$ C)

2. Isat: DC current at which the inductance drops approximate 30% from its value without current;

3. Irms: DC current that causes the temperature rise (Δ T =40 $^{\circ}$ C) from 25 $^{\circ}$ C ambient.

4. Operating Temperature : -25 $^{\circ}$ C ~ +125 $^{\circ}$ C



● SPECIFICATION TABLE:

| PART NUMBER 品名 | INDUCTANCE (μ H) 电感值 | DCR (\pm 30%) (Ω) 直流电阻 | Isat (Max.) (A) 饱和电流 | Irms (Max.) (A) 额定电流 | S.R.F.(Min.) (MHz) 自谐频率 |
|-------------------|---------------------------------|--|----------------------------|----------------------------|-------------------------------|
| CKCS4020-1.0uH/N | 1.0 \pm 30% | 0.029 | 4.78 | 2.15 | 75 |
| CKCS4020-1.2uH/N | 1.2 \pm 30% | 0.029 | 5.10 | 2.15 | 72 |
| CKCS4020-1.5uH/N | 1.5 \pm 30% | 0.035 | 4.45 | 1.98 | 71 |
| CKCS4020-2.2uH/N | 2.2 \pm 30% | 0.040 | 3.40 | 1.85 | 49 |
| CKCS4020-3.3uH/M | 3.3 \pm 20% | 0.070 | 3.20 | 1.40 | 44 |
| CKCS4020-4.7uH/M | 4.7 \pm 20% | 0.075 | 2.35 | 1.34 | 42 |
| CKCS4020-5.6uH/M | 5.6 \pm 20% | 0.090 | 2.20 | 1.22 | 30 |
| CKCS4020-6.8uH/M | 6.8 \pm 20% | 0.125 | 2.00 | 1.04 | 33 |
| CKCS4020-8.2uH/M | 8.2 \pm 20% | 0.125 | 1.75 | 1.04 | 27 |
| CKCS4020-10uH/M | 10 \pm 20% | 0.165 | 1.60 | 0.90 | 26 |
| CKCS4020-15uH/M | 15 \pm 20% | 0.230 | 1.35 | 0.77 | 24 |
| CKCS4020-22uH/M | 22 \pm 20% | 0.350 | 1.05 | 0.62 | 15 |
| CKCS4020-33uH/M | 33 \pm 20% | 0.550 | 0.85 | 0.49 | 11 |
| CKCS4020-47uH/M | 47 \pm 20% | 0.710 | 0.74 | 0.44 | 10 |
| CKCS4020-56uH/M | 56 \pm 20% | 0.800 | 0.66 | 0.41 | 10 |
| CKCS4020-68uH/M | 68 \pm 20% | 1.060 | 0.61 | 0.36 | 7.7 |
| CKCS4020-82uH/M | 82 \pm 20% | 1.170 | 0.50 | 0.34 | 7.2 |
| CKCS4020-100uH/M | 100 \pm 20% | 1.550 | 0.48 | 0.31 | 6.3 |

Remark: 1. Inductance Tested at 100kHz, 1Vrms (20 $^{\circ}$ C)

2. Isat: DC current at which the inductance drops approximate 30% from its value without current;
3. Irms: DC current that causes the temperature rise ($\Delta T = 40^{\circ}C$) from 25 $^{\circ}$ C ambient.
4. Operating Temperature : -25 $^{\circ}$ C ~ +125 $^{\circ}$ C



● SPECIFICATION TABLE:

| PART NUMBER 品名 | INDUCTANCE (μ H) 电感值 | DCR (\pm 30%) (Ω) 直流电阻 | Isat (Max.) (A) 饱和电流 | Irms (Max.) (A) 额定电流 | S.R.F.(Min.) (MHz) 自谐频率 |
|-------------------|---------------------------------|--|----------------------------|----------------------------|-------------------------------|
| CKCS4030-1uH/N | 1.0 \pm 30% | 0.016 | 5.26 | 4.14 | 70 |
| CKCS4030-1.5uH/N | 1.5 \pm 30% | 0.020 | 4.84 | 3.34 | 62 |
| CKCS4030-2.2uH/N | 2.2 \pm 30% | 0.030 | 4.40 | 2.95 | 52 |
| CKCS4030-3.3uH/M | 3.3 \pm 20% | 0.040 | 3.30 | 2.40 | 38 |
| CKCS4030-4.7uH/M | 4.7 \pm 20% | 0.060 | 2.90 | 2.00 | 31 |
| CKCS4030-6.8uH/M | 6.8 \pm 20% | 0.090 | 2.75 | 1.60 | 24 |
| CKCS4030-10uH/M | 10 \pm 20% | 0.100 | 1.95 | 1.50 | 21 |
| CKCS4030-15uH/M | 15 \pm 20% | 0.190 | 1.65 | 1.11 | 16 |
| CKCS4030-22uH/M | 22 \pm 20% | 0.225 | 1.30 | 1.00 | 10 |
| CKCS4030-33uH/M | 33 \pm 20% | 0.330 | 1.10 | 0.84 | 10 |
| CKCS4030-47uH/M | 47 \pm 20% | 0.445 | 0.95 | 0.72 | 8.4 |
| CKCS4030-68uH/M | 68 \pm 20% | 0.868 | 0.72 | 0.52 | 7 |
| CKCS4030-100uH/M | 100 \pm 20% | 1.150 | 0.60 | 0.45 | 5.6 |
| CKCS4030-150uH/M | 150 \pm 20% | 1.800 | 0.50 | 0.3 | 4 |
| CKCS4030-220uH/M | 220 \pm 20% | 2.500 | 0.40 | 0.35 | 4.2 |
| CKCS4030-330uH/M | 330 \pm 20% | 4.000 | 0.30 | 0.25 | 6.8 |
| CKCS4030-470uH/M | 470 \pm 20% | 7.200 | 0.30 | 0.2 | 2 |
| CKCS4030-680uH/M | 680 \pm 20% | 7.580 | 0.19 | 0.14 | 1.2 |

Remark: 1. Inductance Tested at 100kHz, 1Vrms (20 $^{\circ}$ C)

2. Isat: DC current at which the inductance drops approximate 30% from its value without current;

3. Irms: DC current that causes the temperature rise (Δ T =40 $^{\circ}$ C) from 25 $^{\circ}$ C ambient.

4. Operating Temperature : -25 $^{\circ}$ C ~ +125 $^{\circ}$ C



● SPECIFICATION TABLE:

| PART NUMBER 品名 | INDUCTANCE (μ H) 电感值 | DCR (\pm 30%) (Ω) 直流电阻 | Isat (Max.) (A) 饱和电流 | Irms (Max.) (A) 额定电流 | S.R.F.(Min.) (MHz) 自谐频率 |
|-------------------|---------------------------------|--|----------------------------|----------------------------|-------------------------------|
| CKCS5020-1.0uH/N | 1.0 \pm 30% | 0.020 | 4.10 | 3.80 | 114 |
| CKCS5020-1.5uH/N | 1.5 \pm 30% | 0.030 | 4.10 | 3.20 | 68 |
| CKCS5020-2.2uH/N | 2.2 \pm 30% | 0.040 | 3.20 | 2.70 | 57 |
| CKCS5020-3.3uH/N | 3.3 \pm 30% | 0.050 | 2.55 | 2.30 | 46 |
| CKCS5020-4.7uH/M | 4.7 \pm 20% | 0.057 | 2.50 | 2.20 | 37 |
| CKCS5020-6.8uH/M | 6.8 \pm 20% | 0.083 | 2.05 | 1.80 | 30 |
| CKCS5020-8.2uH/M | 8.2 \pm 20% | 0.098 | 1.85 | 1.65 | 26 |
| CKCS5020-10uH/M | 10 \pm 20% | 0.120 | 1.70 | 1.55 | 24 |
| CKCS5020-15uH/M | 15 \pm 20% | 0.165 | 1.35 | 1.25 | 20 |
| CKCS5020-18uH/M | 18 \pm 20% | 0.200 | 1.25 | 1.15 | 16 |
| CKCS5020-22uH/M | 22 \pm 20% | 0.250 | 1.15 | 1.10 | 14 |
| CKCS5020-33uH/M | 33 \pm 20% | 0.400 | 0.92 | 0.90 | 10 |
| CKCS5020-47uH/M | 47 \pm 20% | 0.580 | 0.77 | 0.75 | 7 |
| CKCS5020-68uH/M | 68 \pm 20% | 0.740 | 0.65 | 0.64 | 6 |
| CKCS5020-100uH/M | 100 \pm 20% | 1.100 | 0.53 | 0.40 | 6 |

Remark: 1. Inductance Tested at 100kHz, 1Vrms (20°C)

2. Isat: DC current at which the inductance drops approximate 30% from its value without current;

3. Irms: DC current that causes the temperature rise ($\Delta T = 40^\circ C$) from 25°C ambient.

4. Operating Temperature : -25°C ~ +125°C



● SPECIFICATION TABLE:

| PART NUMBER 品名 | INDUCTANCE (μ H) 电感值 | DCR (\pm 30%) (Ω) 直流电阻 | Isat (Max.) (A) 饱和电流 | Irms (Max.) (A) 额定电流 | S.R.F.(Min.) (MHz) 自谐频率 |
|-------------------|---------------------------------|--|----------------------------|----------------------------|-------------------------------|
| CKCS5040-1.0uH/N | 1.0 \pm 30% | 0.012 | 7.35 | 4.90 | 117 |
| CKCS5040-1.2uH/N | 1.2 \pm 30% | 0.016 | 6.50 | 4.15 | 110 |
| CKCS5040-1.5uH/N | 1.5 \pm 30% | 0.018 | 6.30 | 4.00 | 86 |
| CKCS5040-2.2uH/N | 2.2 \pm 30% | 0.019 | 4.90 | 3.80 | 50 |
| CKCS5040-3.3uH/N | 3.3 \pm 30% | 0.024 | 3.95 | 3.40 | 32 |
| CKCS5040-4.7uH/M | 4.7 \pm 20% | 0.032 | 3.50 | 3.00 | 28 |
| CKCS5040-5.6uH/M | 5.6 \pm 20% | 0.035 | 3.00 | 2.80 | 27 |
| CKCS5040-6.8uH/M | 6.8 \pm 20% | 0.043 | 2.90 | 2.50 | 21 |
| CKCS5040-10uH/M | 10 \pm 20% | 0.064 | 2.35 | 2.10 | 18 |
| CKCS5040-15uH/M | 15 \pm 20% | 0.086 | 2.00 | 2.00 | 13 |
| CKCS5040-22uH/M | 22 \pm 20% | 0.129 | 1.60 | 1.50 | 11 |
| CKCS5040-33uH/M | 33 \pm 20% | 0.188 | 1.30 | 1.20 | 9.1 |
| CKCS5040-47uH/M | 47 \pm 20% | 0.272 | 1.10 | 1.00 | 6.7 |
| CKCS5040-68uH/M | 68 \pm 20% | 0.400 | 0.90 | 0.80 | 5.7 |
| CKCS5040-100uH/M | 100 \pm 20% | 0.560 | 0.75 | 0.70 | 4.7 |
| CKCS5040-150uH/M | 150 \pm 20% | 0.750 | 0.65 | 0.60 | 5 |
| CKCS5040-220uH/M | 220 \pm 20% | 1.280 | 0.40 | 0.38 | 3 |
| CKCS5040-1mH/M | 1000 \pm 20% | 6.200 | 0.25 | 0.25 | 2 |
| CKCS5040-2.2mH/M | 2200 \pm 20% | 13.000 | 0.10 | 0.10 | 2 |

Remark: 1. Inductance Tested at 100kHz, 1Vrms (20 $^{\circ}$ C)

2. Isat: DC current at which the inductance drops approximate 30% from its value without current;
3. Irms: DC current that causes the temperature rise (Δ T =40 $^{\circ}$ C) from 25 $^{\circ}$ C ambient.
4. Operating Temperature : -25 $^{\circ}$ C ~ +125 $^{\circ}$ C



● SPECIFICATION TABLE:

| PART NUMBER 品名 | INDUCTANCE (μ H) 电感值 | DCR (\pm 30%) (Ω) 直流电阻 | Isat (Max.) (A) 饱和电流 | Irms (Max.) (A) 额定电流 | S.R.F.(Min.) (MHz) 自谐频率 |
|-------------------|---------------------------------|--|----------------------------|----------------------------|-------------------------------|
| CKCS6020-0.68uH/N | 0.68 \pm 30% | 0.017 | 6.55 | 3.80 | 115 |
| CKCS6020-0.82uH/N | 0.82 \pm 30% | 0.017 | 5.30 | 3.80 | 110 |
| CKCS6020-1.0uH/N | 1.0 \pm 30% | 0.020 | 4.15 | 3.50 | 100 |
| CKCS6020-1.5uH/N | 1.5 \pm 30% | 0.022 | 4.25 | 3.20 | 79 |
| CKCS6020-2.2uH/N | 2.2 \pm 30% | 0.028 | 3.75 | 2.75 | 61 |
| CKCS6020-3.3uH/N | 3.3 \pm 30% | 0.035 | 3.15 | 2.60 | 51 |
| CKCS6020-4.7uH/M | 4.7 \pm 20% | 0.058 | 3.00 | 2.00 | 41 |
| CKCS6020-6.8uH/M | 6.8 \pm 20% | 0.079 | 2.20 | 1.80 | 31 |
| CKCS6020-10uH/M | 10 \pm 20% | 0.105 | 1.75 | 1.40 | 27 |
| CKCS6020-12uH/M | 12 \pm 20% | 0.120 | 1.45 | 1.30 | 25 |
| CKCS6020-15uH/M | 15 \pm 20% | 0.145 | 1.20 | 1.20 | 21 |
| CKCS6020-18uH/M | 18 \pm 20% | 0.180 | 1.20 | 1.08 | 18 |
| CKCS6020-22uH/M | 22 \pm 20% | 0.204 | 1.05 | 1.00 | 16 |
| CKCS6020-33uH/M | 33 \pm 20% | 0.300 | 0.95 | 0.84 | 11 |
| CKCS6020-47uH/M | 47 \pm 20% | 0.430 | 0.70 | 0.80 | 10 |

Remark: 1. Inductance Tested at 100kHz, 1Vrms (20 $^{\circ}$ C)

2. Isat: DC current at which the inductance drops approximate 30% from its value without current;
3. Irms: DC current that causes the temperature rise (Δ T =40 $^{\circ}$ C) from 25 $^{\circ}$ C ambient.
4. Operating Temperature : -25 $^{\circ}$ C ~ +125 $^{\circ}$ C



● SPECIFICATION TABLE:

| PART NUMBER 品名 | INDUCTANCE (μ H) 电感值 | DCR (\pm 30%) (Ω) 直流电阻 | Isat (Max.) (A) 饱和电流 | Irms (Max.) (A) 额定电流 | S.R.F.(Min.) (MHz) 自谐频率 |
|-------------------|---------------------------------|--|----------------------------|----------------------------|-------------------------------|
| CKCS6028-1.0uH/N | 1.0 \pm 30% | 0.012 | 5.75 | 5.20 | 70 |
| CKCS6028-1.5uH/N | 1.5 \pm 30% | 0.015 | 6.00 | 4.58 | 65 |
| CKCS6028-2.2uH/N | 2.2 \pm 30% | 0.020 | 5.10 | 3.75 | 48 |
| CKCS6028-3.3uH/N | 3.3 \pm 30% | 0.025 | 4.15 | 3.48 | 41 |
| CKCS6028-4.7uH/N | 4.7 \pm 30% | 0.030 | 3.00 | 3.08 | 35 |
| CKCS6028-6.8uH/M | 6.8 \pm 20% | 0.047 | 2.60 | 2.40 | 27 |
| CKCS6028-10uH/M | 10 \pm 20% | 0.072 | 2.04 | 1.95 | 23 |
| CKCS6028-12uH/M | 12 \pm 20% | 0.080 | 1.80 | 1.85 | 18 |
| CKCS6028-15uH/M | 15 \pm 20% | 0.125 | 1.75 | 1.45 | 18 |
| CKCS6028-18uH/M | 18 \pm 20% | 0.120 | 1.52 | 1.45 | 15 |
| CKCS6028-22uH/M | 22 \pm 20% | 0.140 | 1.45 | 1.40 | 14 |
| CKCS6028-33uH/M | 33 \pm 20% | 0.185 | 1.35 | 1.22 | 12 |
| CKCS6028-47uH/M | 47 \pm 20% | 0.315 | 1.15 | 1.06 | 9.5 |
| CKCS6028-68uH/M | 68 \pm 20% | 0.360 | 0.80 | 0.86 | 7.7 |
| CKCS6028-82uH/M | 82 \pm 20% | 0.500 | 0.80 | 0.70 | 7.7 |
| CKCS6028-100uH/M | 100 \pm 20% | 0.500 | 0.65 | 0.70 | 7.1 |
| CKCS6028-1mH/M | 1000 \pm 20% | 5.800 | 0.18 | 0.20 | 1.5 |

Remark: 1. Inductance Tested at 100kHz, 1Vrms (20°C)

2. Isat: DC current at which the inductance drops approximate 30% from its value without current;

3. Irms: DC current that causes the temperature rise ($\Delta T = 40^\circ C$) from 25°C ambient.

4. Operating Temperature : -25°C ~ +125°C



● SPECIFICATION TABLE:

| PART NUMBER 品名 | INDUCTANCE (μ H) 电感值 | DCR (\pm 30%) (Ω) 直流电阻 | Isat (Max.) (A) 饱和电流 | Irms (Max.) (A) 额定电流 | S.R.F.(Min.) (MHz) 自谐频率 |
|-------------------|---------------------------------|--|----------------------------|----------------------------|-------------------------------|
| CKCS6045-1.0uH/N | 1.0 \pm 30% | 0.011 | 9.85 | 5.14 | 100 |
| CKCS6045-1.5uH/N | 1.5 \pm 30% | 0.012 | 8.80 | 4.95 | 65 |
| CKCS6045-2.2uH/N | 2.2 \pm 30% | 0.014 | 6.75 | 4.60 | 52 |
| CKCS6045-3.3uH/N | 3.3 \pm 30% | 0.024 | 5.90 | 3.70 | 32 |
| CKCS6045-4.7uH/M | 4.7 \pm 20% | 0.031 | 4.97 | 3.30 | 24 |
| CKCS6045-6.8uH/M | 6.8 \pm 20% | 0.035 | 3.90 | 3.00 | 20 |
| CKCS6045-10uH/M | 10 \pm 20% | 0.048 | 3.20 | 2.45 | 15 |
| CKCS6045-15uH/M | 15 \pm 20% | 0.068 | 2.50 | 2.05 | 12 |
| CKCS6045-22uH/M | 22 \pm 20% | 0.089 | 2.05 | 1.80 | 10 |
| CKCS6045-33uH/M | 33 \pm 20% | 0.137 | 1.65 | 1.45 | 7.8 |
| CKCS6045-47uH/M | 47 \pm 20% | 0.200 | 1.40 | 1.20 | 6.4 |
| CKCS6045-56uH/M | 56 \pm 20% | 0.221 | 1.30 | 1.10 | 6.4 |
| CKCS6045-68uH/M | 68 \pm 20% | 0.289 | 1.20 | 1.00 | 6.4 |
| CKCS6045-100uH/M | 100 \pm 20% | 0.433 | 0.95 | 0.80 | 4.2 |
| CKCS6045-120uH/M | 120 \pm 20% | 0.484 | 0.85 | 0.77 | 4.2 |
| CKCS6045-150uH/M | 150 \pm 20% | 0.580 | 0.80 | 0.70 | 4.2 |
| CKCS6045-220uH/M | 220 \pm 20% | 0.834 | 0.70 | 0.59 | 3.5 |
| CKCS6045-330uH/M | 330 \pm 20% | 1.270 | 0.57 | 0.57 | 2.8 |
| CKCS6045-470uH/M | 470 \pm 20% | 1.800 | 0.50 | 0.42 | 2 |
| CKCS6045-680uH/M | 680 \pm 20% | 2.500 | 0.42 | 0.33 | 1.7 |
| CKCS6045-1mH/M | 1000 \pm 20% | 4.500 | 0.30 | 0.30 | 1.4 |
| CKCS6045-1.5mH/M | 1500 \pm 20% | 6.500 | 0.24 | 0.21 | 0.8 |

Remark: 1. Inductance Tested at 100kHz, 1Vrms (20°C)

2. Isat: DC current at which the inductance drops approximate 30% from its value without current;

3. Irms: DC current that causes the temperature rise ($\Delta T = 40^\circ C$) from 25°C ambient.

4. Operating Temperature : -25°C ~ +125°C



● SPECIFICATION TABLE:

| PART NUMBER 品名 | INDUCTANCE (μ H) 电感值 | DCR (\pm 30%) (Ω) 直流电阻 | Isat (Max.) (A) 饱和电流 | Irms (Max.) (A) 额定电流 | S.R.F.(Min.) (MHz) 自谐频率 |
|-------------------|---------------------------------|--|----------------------------|----------------------------|-------------------------------|
| CKCS8040-0.82uH/N | 0.82 \pm 30% | 0.008 | 13.80 | 6.30 | 94 |
| CKCS8040-1.0uH/N | 1.0 \pm 30% | 0.008 | 9.85 | 6.30 | 89 |
| CKCS8040-1.5uH/N | 1.5 \pm 30% | 0.010 | 8.15 | 5.65 | 67 |
| CKCS8040-2.2uH/N | 2.2 \pm 30% | 0.012 | 7.10 | 5.15 | 41 |
| CKCS8040-3.3uH/N | 3.3 \pm 30% | 0.017 | 6.50 | 4.40 | 27 |
| CKCS8040-4.7uH/N | 4.7 \pm 30% | 0.019 | 5.90 | 4.10 | 24 |
| CKCS8040-6.8uH/M | 6.8 \pm 20% | 0.024 | 4.55 | 3.60 | 20 |
| CKCS8040-8.2uH/M | 8.2 \pm 20% | 0.026 | 4.20 | 3.45 | 17 |
| CKCS8040-10uH/M | 10 \pm 20% | 0.042 | 3.60 | 3.30 | 15 |
| CKCS8040-15uH/M | 15 \pm 20% | 0.047 | 2.95 | 2.60 | 12 |
| CKCS8040-18uH/M | 18 \pm 20% | 0.053 | 2.70 | 2.40 | 11 |
| CKCS8040-22uH/M | 22 \pm 20% | 0.069 | 2.40 | 2.10 | 9.5 |
| CKCS8040-33uH/M | 33 \pm 20% | 0.097 | 2.05 | 1.80 | 7.8 |
| CKCS8040-47uH/M | 47 \pm 20% | 0.136 | 1.75 | 1.55 | 6.4 |
| CKCS8040-68uH/M | 68 \pm 20% | 0.196 | 1.45 | 1.25 | 4.9 |
| CKCS8040-82uH/M | 82 \pm 20% | 0.225 | 1.30 | 1.15 | 4.9 |
| CKCS8040-100uH/M | 100 \pm 20% | 0.290 | 1.15 | 1.00 | 4.2 |
| CKCS8040-120uH/M | 120 \pm 20% | 0.334 | 1.05 | 0.95 | 3.5 |
| CKCS8040-150uH/M | 150 \pm 20% | 0.410 | 1.10 | 0.85 | 3.5 |
| CKCS8040-220uH/M | 220 \pm 20% | 0.599 | 0.85 | 0.80 | 3.5 |
| CKCS8040-330uH/M | 330 \pm 20% | 0.889 | 0.68 | 0.64 | 2.8 |
| CKCS8040-470uH/M | 470 \pm 20% | 1.260 | 0.60 | 0.54 | 2.1 |
| CKCS8040-680uH/M | 680 \pm 20% | 2.040 | 0.50 | 0.45 | 1.7 |
| CKCS8040-1mH/M | 1000 \pm 20% | 2.800 | 0.40 | 0.35 | 1.4 |

Remark: 1. Inductance Tested at 100kHz, 1Vrms (20°C)

2. Isat: DC current at which the inductance drops approximate 30% from its value without current;
3. Irms: DC current that causes the temperature rise ($\Delta T = 40^\circ C$) from 25°C ambient.
4. Operating Temperature : -25°C ~ +125°C



● **PACKAGING SPECIFICATION :**

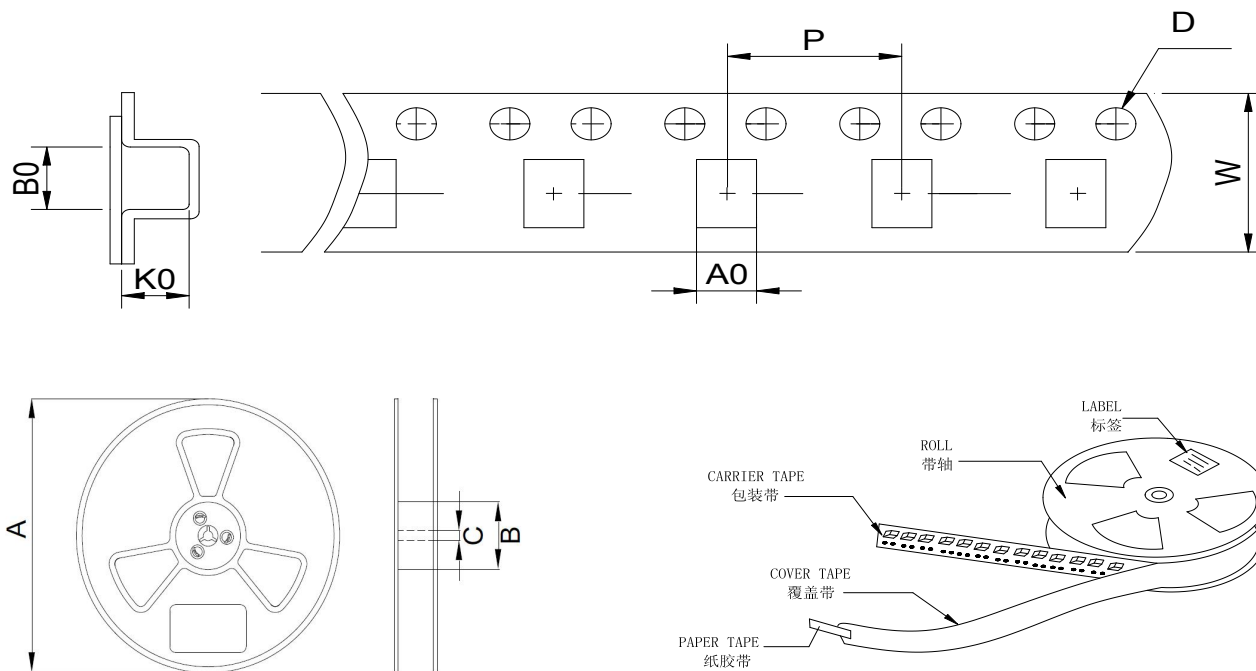

| Type | Tape Dimension (mm) | | | | | | Reel Dimension (mm) | | | Quantity (Pcs/Reel) |
|------------|---------------------|------|------|------|-----|----|---------------------|-----|----|---------------------|
| | W | A0 | B0 | K0 | D | P | A | B | C | |
| CKCS201610 | 8 | 1.9 | 2.3 | 1.2 | 1.5 | 4 | 178 | 58 | 13 | 2000 |
| CKCS252010 | 8 | 2.4 | 2.9 | 1.25 | 1.5 | 4 | 178 | 58 | 13 | 2000 |
| CKCS252012 | 8 | 2.35 | 2.65 | 1.6 | 1.5 | 4 | 178 | 58 | 13 | 2000 |
| CKCS3010 | 8 | 3.3 | 3.3 | 1.4 | 1.5 | 4 | 178 | 58 | 13 | 2000 |
| CKCS3012 | 8 | 3.3 | 3.3 | 1.6 | 1.5 | 4 | 178 | 58 | 13 | 2000 |
| CKCS3015 | 8 | 3.3 | 3.3 | 1.9 | 1.5 | 4 | 178 | 58 | 13 | 2000 |
| CKCS4012 | 12 | 4.3 | 4.3 | 1.4 | 1.5 | 8 | 330 | 100 | 13 | 4000 |
| CKCS4018 | 12 | 4.3 | 4.3 | 2.2 | 1.5 | 8 | 330 | 100 | 13 | 3000 |
| CKCS4020 | 12 | 4.3 | 4.3 | 2.4 | 1.5 | 8 | 330 | 100 | 13 | 3000 |
| CKCS4030 | 12 | 4.3 | 4.3 | 3.4 | 1.5 | 8 | 330 | 100 | 13 | 2000 |
| CKCS5020 | 12 | 5.4 | 5.4 | 2.4 | 1.5 | 8 | 330 | 100 | 13 | 3000 |
| CKCS5040 | 12 | 5.4 | 5.4 | 4.4 | 1.5 | 8 | 330 | 100 | 13 | 1500 |
| CKCS6020 | 16 | 6.4 | 6.4 | 2.4 | 1.5 | 8 | 330 | 100 | 13 | 2500 |
| CKCS6028 | 16 | 6.4 | 6.4 | 3.2 | 1.5 | 8 | 330 | 100 | 13 | 2000 |
| CKCS6045 | 16 | 6.4 | 6.4 | 4.8 | 1.5 | 8 | 330 | 100 | 13 | 1500 |
| CKCS8040 | 16 | 8.4 | 8.4 | 4.4 | 1.5 | 12 | 330 | 100 | 13 | 1000 |

X-ON Electronics

Largest Supplier of Electrical and Electronic Components

Click to view similar products for [Fixed Inductors](#) category:

Click to view products by [CENKER](#) manufacturer:

Other Similar products are found below :

[CR43NP-680KC](#) [CR54NP-470LC](#) [CR54NP-820KC](#) [CR54NP-8R5MC](#) [70F224AI](#) [MGDQ4-00004-P](#) [MHL1ECTTP18NJ](#) [MHQ1005P10NJ](#)
[MHQ1005P1N0S](#) [MHQ1005P2N4S](#) [MHQ1005P3N6S](#) [MHQ1005P5N1S](#) [MHQ1005P8N2J](#) [PE-51506NL](#) [PE-53601NL](#) [PE-53602NL](#) [PE-53630NL](#) [PE-53824SNLT](#) [PE-92100NL](#) [PG0434.801NLT](#) [PG0936.113NLT](#) [9220-20](#) [9310-16](#) [PM06-2N7](#) [PM06-39NJ](#) [A01TK](#) [1206CS-471XJ](#) [HC2LP-R47-R](#) [HC2-R47-R](#) [HC3-2R2-R](#) [HC3-R50-R](#) [HC8-1R2-R](#) [HCF1305-3R3-R](#) [1206CS-151XG](#) [RCH664NP-140L](#) [RCH664NP-4R7M](#) [RCH8011NP-221L](#) [RCP1317NP-332L](#) [RCP1317NP-391L](#) [RCR1010NP-470M](#) [RCR110DNP-331L](#) [DH2280-4R7M](#) [DS1608C-106](#)
[ASPI-4020HI-R10M-T](#) [B10TJ](#) [B82498B3101J000](#) [ELJ-RE27NJF2](#) [1812CS-153XJ](#) [1812CS-183XJ](#) [1812CS-223XJ](#)