

产品承认书

SPECIFICATION FOR APPROVED

版本: REV.A3

客户 : 1186
Customer :
客户料号 : 201020018130 
Customer P/N :
品名 : 工字电感
Description : RADIAL TYPE CHOKE INDUCTOR
产品型号 : CKPK0608-680uH/K-U3.3
CENKER P/N :
图纸编号 : SP-CK112-00025979
Drawing No. :
产品编号 :
Product code. :

出图 DRAWING		
制表 Prepared By	审核 Checked By	批准 Approved By
文坚明	梁贵传	梁贵传
DATE: 2019-4-11		

承认 CUSTOMER APPROVAL
DATE:



深圳市岑科实业有限公司

SHENZHEN CENKER ENTERPRISE LTD.

地址:深圳市龙华区清泉路金博龙工业园C栋

Address: Building No.C Jinbolong Industrial Estate, Qingquan Road, Longhua District, Shenzhen P.R.China

TEL:0755-89808755 FAX:0755-27525256

SPECIFICATION FOR APPROVAL

RoHS COMPLIANT

客户 CUSTOMER	1186	客户料号 CUSTOMER No.	201020018130	页次 PAGE
岑科料号 CENKER P/N	CKPK0608-680uH/K-U3.3	图纸编号 DRAWING No.	SP-CK112-00025979	1/4
日期 ISSUE DATE	2019-4-11	版本 VERSION	A3	

1、DIMENSION (mm):

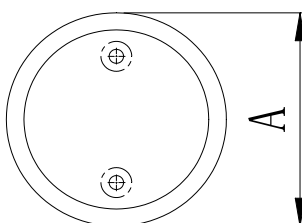
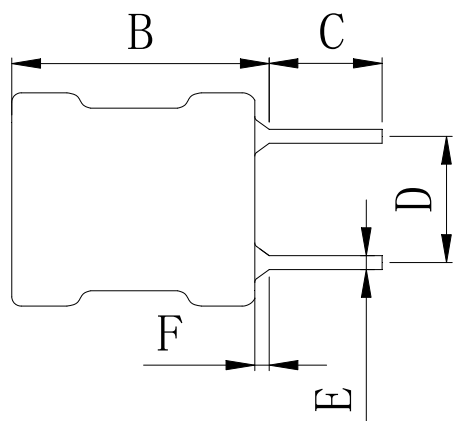

SCHEMATIC

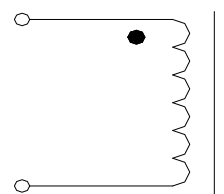

A	B	C	D	E	F
Φ 8.0Max	11Max	3.3±0.5	3.0±0.5	Φ0.6±0.05	1.5Max

CKPK 0608 - 680uH K - U 3.3

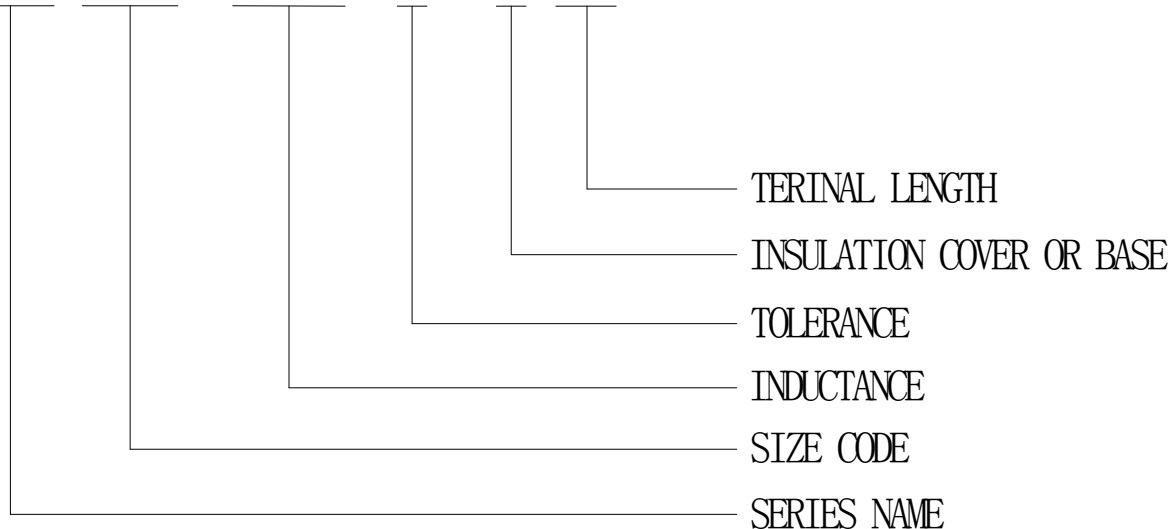

2、温度比率 TEMPERATURE RATING:

运行温度 Operating Temperature : -25℃ ~ +85℃ ; 储存温度 Storage Temperature : -25℃ ~ +85℃

 深圳市岑科实业有限公司 SHEN ZHEN CENKER ENTERPRISE LTD. TEL:0755-89808755 FAX:0755-27525256	制表 PREPARED	审核 CHECKED	批准 APPROVED
	文坚明	梁贵传	梁贵传

SPECIFICATION FOR APPROVAL

RoHS COMPLIANT

客户 CUSTOMER	1186	客户料号 CUSTOMER No.	201020018130	页次 PAGE
岑科料号 CENKER P/N	CKPK0608-680uH/K-U3.3	图纸编号 DRAWING No.	SP-CK112-00025979	2/4
日期 ISSUE DATE	2019-4-11	版本 VERSION	A3	

3、ELECTRICAL REQUIREMENTS:

部品 ITEM	规格 SPEC.	公差 TOLERANCE	测试频率TEST FREQUENCY	测试仪器TEST EQUIPMENT
电感值 INDUCTANCE	680UH	± 10%	1kHz /0.25V	HP-4284A
直流电阻 DCR	2.2Ω	Max	At 25°C	CH-502A
电流 IDC	0.25A	L0A×90%Min	10kHz /0.25V	CD1068+CD1320
 Q值 Q	1.5	Min	1kHz /0.25V	HP-4284A

4、MATERIAL LIST:

No.	原材料Material	规格 Specification	供应商 Supplier	备注 Remark
1	Core	SR60 DR 6*8 FSO	东晨	
2	Wire	Φ0.18mm*165.5Ts Ref (2UEW)	 深港	155°C
3	Solder	Sn99.3-Cu0.7	昌升	
4	Tube	UL Φ6×10.5mm(BLACK)	沃尔/星启	
5	Epoxy	J-600	岑科	
6	Pin	CP Φ0.6×17.5mm	岑科/百川	



深圳市岑科实业有限公司
SHEN ZHEN CENKER ENTERPRISE LTD.
TEL:0755-89808755 FAX:0755-27525256

制表
PREPARED

文坚明

审核
CHECKED

梁贵传

批准
APPROVED

梁贵传

客户 CUSTOMER	1186		LOT No.			
客户料号 CUSTOMER No.	201020018130		QUANTITY	10PCS	DATE	2019-4-11
图纸编号 DRAWING No.	SP-CK112-00025979		DIMENSION(UNIT: mm)			
零件料号 CENKER P/N	CKPK0608-680uH/K-U3.3					
部品 DESCRIPTION	工字电感 RADIAL TYPE CHOKE INDUCTOR					
测试条件 TEST FREQ	1kHz /0.25V, 10kHz /0.25V					
温度 TEMPERATURE	25 °C	湿度HUMIDITY				

5、测试数据

TESTING DATA:

电器参数 ELECTRONICAL TEST DATA					尺寸 OREALL DIMENSTON (UNIT: mm)								
	L	DCR (Ω)	0.25A	Q	A	B	C	D	E	F			
SPE C	680UH ±10%	2.2Ω Max	L0A*90% Ref.	1.5 Min	Φ8.0Max	11Max	3.3±0.5	3.0±0.5	Φ 0.6±0.0	1.5Max			
1	691.34	1.55	656.77	2.67	6.53	9.39	3.34	3.07	0.61	0.94			
2	692.33	1.56	657.71	2.59	6.54	9.38	3.35	3.05	0.59	0.91			
3	687.38	1.56	653.01	2.64	6.51	9.35	3.31	3.02	0.58	0.95			
4	713.67	1.56	677.98	2.59	6.50	9.36	3.29	3.03	0.62	0.92			
5	684.42	1.56	650.19	2.58	6.56	9.40	3.30	3.05	0.63	0.96			
6	688.06	1.55	653.65	2.66	6.49	9.42	3.35	2.99	0.60	0.93			
7	689.00	1.53	654.59	2.69	6.48	9.38	3.36	2.98	0.61	0.89			
8	690.73	1.55	656.24	2.63	6.52	9.37	3.34	2.96	0.58	0.96			
9	689.28	1.53	654.24	2.22	6.51	9.42	3.29	3.06	0.59	0.91			
10	689.24	1.55	654.47	2.68	6.53	9.44	3.28	3.04	0.58	0.95			
\bar{X}	691.55	1.55	656.89	2.60	6.52	9.39	3.32	3.03	0.60	0.93			
R	29.25	0.03	27.79	0.47	0.08	0.09	0.08	0.11	0.04	0.07			

TEST EQUIPMENT:

ALL JUDGE

OK NG

L CH-1062A HP-4284A

Q HM2801A HM9481 CJ2851

DCR CH-502A

SRF HM9460

IDC CD1068+CD1320 HM-2713-1+HM-2791 LCR



深圳市岑科实业有限公司

SHEN ZHEN CENKER ENTERPRISE LTD.

TEL:0755-89808755 FAX:0755-27525256

PREPARED

CHECKED

APPROVED

文坚明

梁贵传

梁贵传

客户 CUSTOMER	1186	客户料号 CUSTOMER No.	201020018130	页次 PAGE
岑科料号 CENKER P/N	CKPK0608-680uH/K-U3.3	图纸编号 DRAWING No.	SP-CK112-00025979	4/4
日期 ISSUE DATE	2019-4-11	版本 VERSION	A3	

6、包装 PACKING (mm):

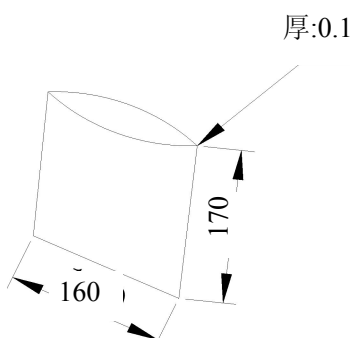
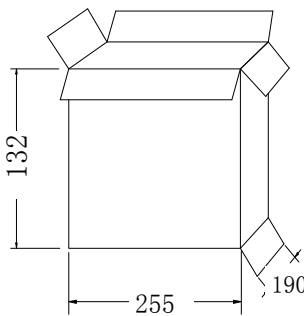
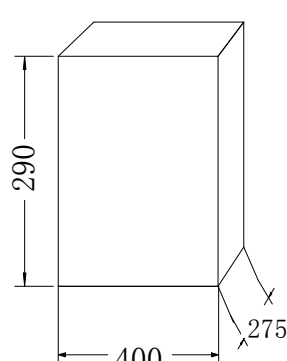
<p>1. PE袋尺寸: 160*170*0.1mm (500PCS/袋);</p>	 <p>厚:0.1</p>
<p>2. 内箱尺寸: 255*190*132mm (装10PE袋,数量5KPCS) 材质A3A;</p>	
<p>3. 外箱尺寸: 400*275*290mm (装4个内箱, 数量为20K/PCS) 材质A+1+A;</p>	

 <p>深圳市岑科实业有限公司 SHEN ZHEN CENKER ENTERPRISE LTD. TEL:0755-89808755 FAX:0755-27525256</p>	PREPARED	CHECKED	APPROVED
	文坚明	梁贵传	梁贵传

SPECIFICATION FOR APPROVAL

RoHS COMPLIANT

客户 CUSTOMER	1186	客户料号 CUSTOMER No.	201020018130	PAGE
岑科料号 CENKER P/N	CKPK0608-680uH/K-U3.3	图纸编号 DRAWING No.	SP-CK112-00025979	5/5
日期ISSUE DATE	2019-4-11	版本 VERSION	A3	

**电感值VS直流电流
INDUCTANCE (μ H) VS DC BIAS (A) CURVE**

DC BIAS (A)	Inductance (μ H)					
0.00 A	693.00					
0.10 A	690.00					
0.15 A	685.00					
0.20 A	678.00					
0.25 A	654.00					
0.30 A	618.00					
0.35 A	554.00					
0.40 A	480.00					

TESTING CONDITION: 1kHz ,0.25Vrms

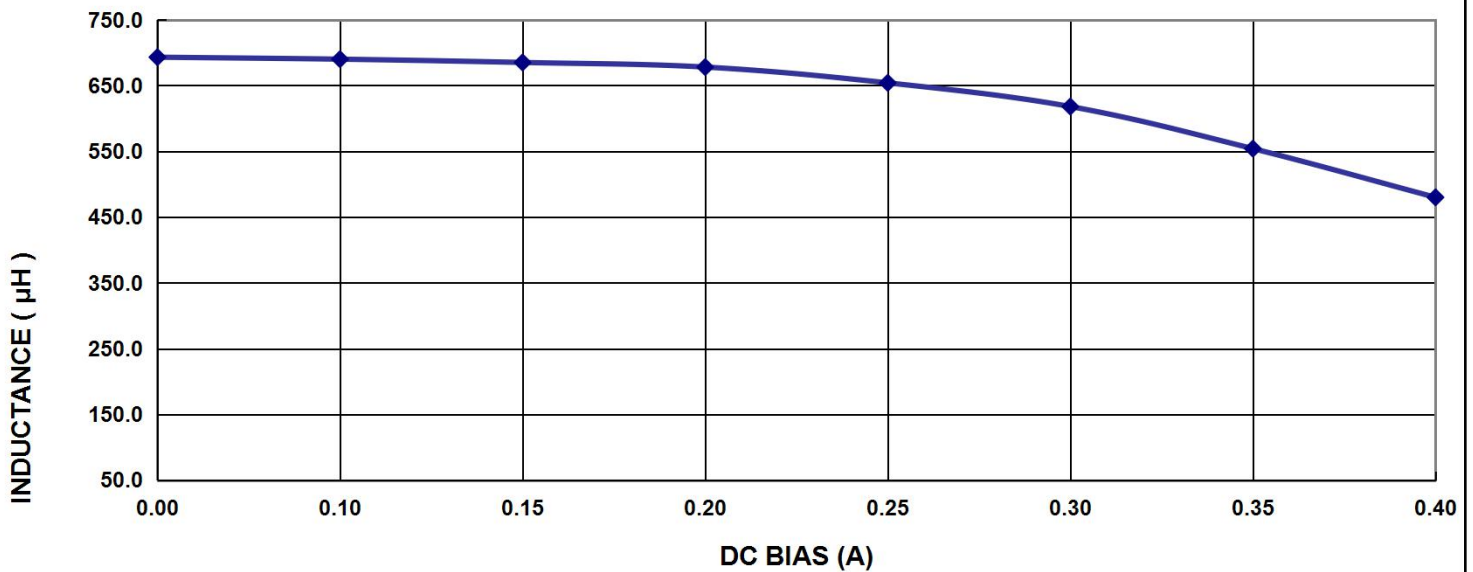

 <p align="center">深圳市岑科实业有限公司 SHEN ZHEN CENKER ENTERPRISE LTD. TEL:0755-89808755 FAX:0755-27525256</p>	PREPARED	CHECKED	APPROVED

X-ON Electronics

Largest Supplier of Electrical and Electronic Components

Click to view similar products for [Fixed Inductors](#) category:

Click to view products by [CENKER](#) manufacturer:

Other Similar products are found below :

[CR32NP-100KC](#) [CR54NP-470LC](#) [70F224AI](#) [MGDQ4-00004-P](#) [MHQ1005P10NJ](#) [MHQ1005P1N0S](#) [MHQ1005P2N4S](#) [MHQ1005P3N6S](#)
[MHQ1005P5N1S](#) [MHQ1005P8N2J](#) [PE-53601NL](#) [PE-53602NL](#) [PG0936.113NLT](#) [9220-20](#) [9310-16](#) [PM06-2N7](#) [PM06-39NJ](#) [A01TK](#)
[1206CS-471XJ](#) [HC2-R47-R](#) [HC8-1R2-R](#) [HCF1305-3R3-R](#) [1206CS-151XG](#) [RCH664NP-140L](#) [RCH664NP-4R7M](#) [RCP1317NP-391L](#)
[RCR110DNP-331L](#) [DH2280-4R7M](#) [DS1608C-106](#) [B10TJ](#) [B82498B3101J000](#) [ELJ-RE27NJF2](#) [1812CS-153XJ](#) [1812CS-183XJ](#) [1812CS-](#)
[223XJ](#) [1812LS-104XJ](#) [1812LS-105XJ](#) [1812LS-124XJ](#) [1812LS-154XJ](#) [1812LS-223XJ](#) [1812LS-224XJ](#) [1812LS-563XJ](#) [1812LS-683XJ](#)
[1812LS-824XJ](#) [NIN-FB101JTR110F](#) [NIN-FB471JTR62F](#) [NIN-FC1R5JTR220F](#) [NIN-HCR15JTRF](#) [NIN-HCR33JTRF](#) [NIN-HDR22JTRF](#)