

DIN 41612 CONNECTORS

DNR SERIES

INTRODUCTION:

DNR Series DIN 41612 connectors are a versatile two piece PCB connector set with features useful for many applications including connections between plug-in card and back-panel wiring, PCB to PCB attachment and peripheral connections for external interfaces. Features include a multitude of body sizes and styles with options that include selective contact loading, make and break contacts, contact lead length choices, and contact plating variations each in .100" [2.54] or .200" [5.08] centerline spacing.

FEATURES:

Industry Standard Compatible
Multiple Body Sizes
Contact Plating Options
Make and Break contacts
.100" or .200" Centerlines

Mating Options:

DNR series and All industry standard DIN 41612 Connectors.

SPECIFICATIONS:

Material:

Standard insulator: PBT, glass filled, rated UL94V-0
Optional Hi-Temp insulator: Nylon 6T, rated UL94V-0
Insulator Color: Beige
Contacts: Brass or Phosphor Bronze

Plating:

Gold over nickel underplate on contact area
Tin over copper underplate on tails

Electrical:

Operating voltage: 500V AC max.
Current rating: 2 Amps max
Contact resistance: 30 mΩ max. initial
Insulation resistance: 1000 MΩ min.
Dielectric withstanding voltage: 1000V AC for 1 minute

Mechanical:

Insertion force: 20 lbs / contact max.
Withdrawal force: 0.033 lbs / contact min
Mating durability: Class I: 500 cycles
Class II: 250 cycles
Class III: 100 cycles

Temperature Rating:

Operating temperature: -55°C to +125°C
Soldering process temperature:
Standard insulator: 235°C
Hi-Temp insulator: 260°C

PACKAGING:

Anti-ESD plastic trays or tubes

APPROVALS AND CERTIFICATIONS:

UL Recognized & CSA Certified,
File no. E224053

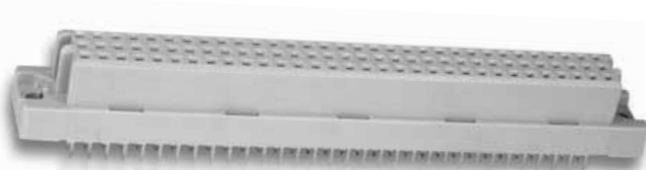

ORDERING INFORMATION

DIN

SERIES INDICATOR

DIN = DIN 41612 Connector

96

NO. OF CONTACTS

Short body 2 rows: 16, 32
Short body 3 rows: 16, 32, 48
Long body 2 rows: 32, 64
Long body 3 rows: 32, 64, 96
Long body 4 rows: 100, 128, 160, 200, 240

M

GENDER

M = Male, Pin Contacts
F = Female, Socket Contacts

R

MOUNTING ANGLE

S = Straight, PCB mount
R = Right Angle, PCB mount

L33

BODY TYPE

S22 = Short body, 2 rows
A & B Loaded
S32 = Short body, 3 rows
A & C Loaded
S33 = Short body, 3 rows
A, B & C Loaded
L22 = Long body, 2 rows
A & B Loaded
L32 = Long body, 3 rows
A & C Loaded
L33 = Long body, 3 rows
A, B & C Loaded
L44 = Long body, 4 rows
A, B, C & D Loaded

A

PITCH

A = .100" [2.54 mm]
B = .200" [5.08 mm]

1

SOLDER TAIL LENGTH

1 = Standard solder tail length .157"
2 = Wire wrap .511" Solder tail (straight female only)

OPTIONS:

Add designator(s) to end of part number

PF = Press Fit Tails (pg 241)

HT = Hi-Temp insulator 260°C max.

BL = Metal board locks in mounting holes

C1 = 30u" Gold over nickel underplate

C2 = 15u" gold over nickel underplate

DIN 41612 CONNECTORS

INVERSE TYPE R

DNR SERIES

DIN-96MS-L33-A1C1
INVERSE DIN TYPE R MALE
3 ROW STRAIGHT

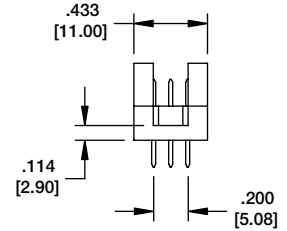
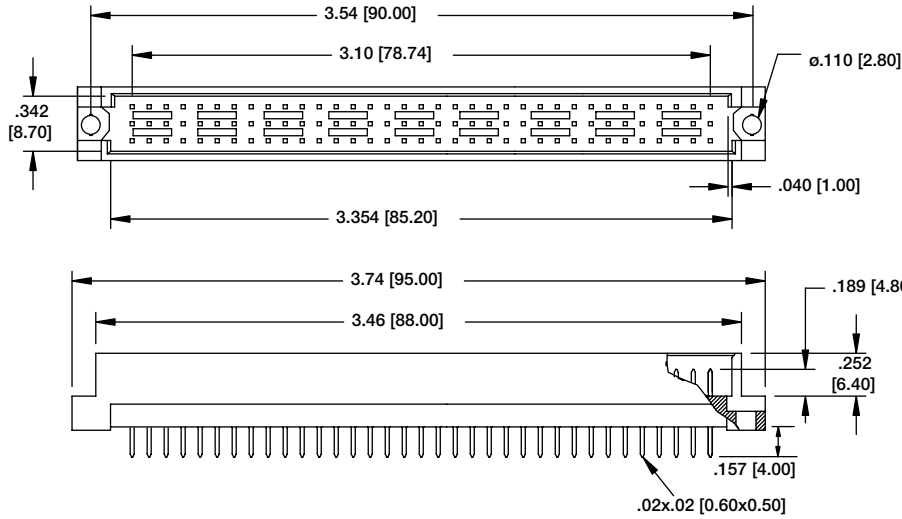

DIN-96FR-L33-A1C1
FEMALE TYPE R
RIGHT ANGLE

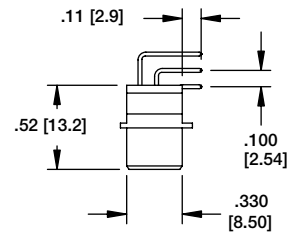
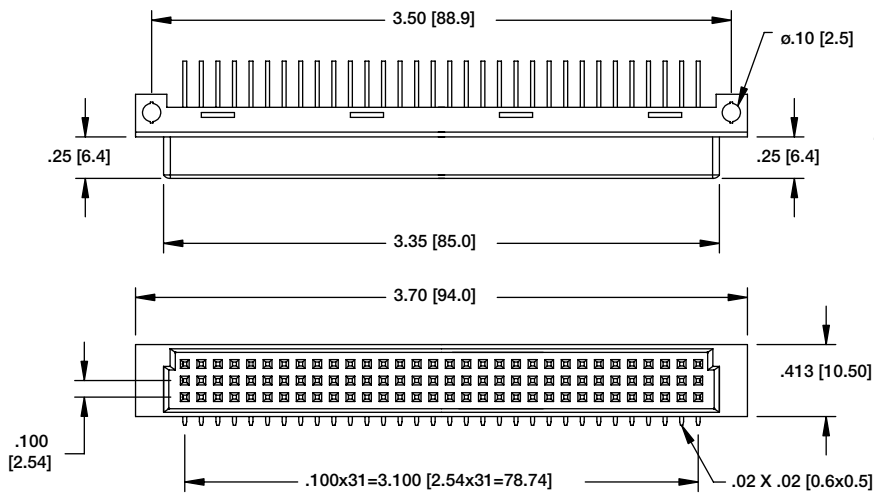

Press Fit Option

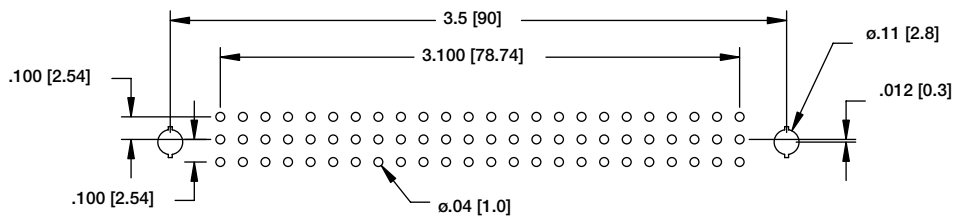
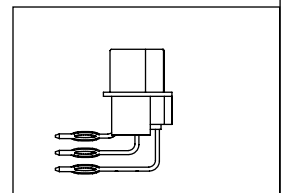

Recommended PCB Layout - Male

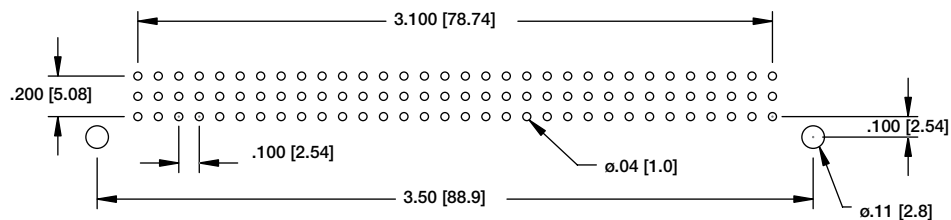

Recommended PCB Layout - Female

DIN 41612 CONNECTORS

STANDARD TYPE C

DNR SERIES

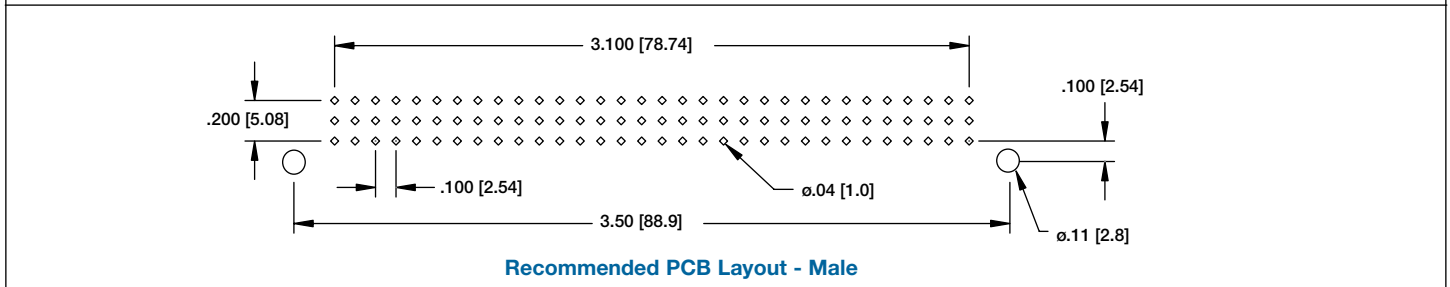
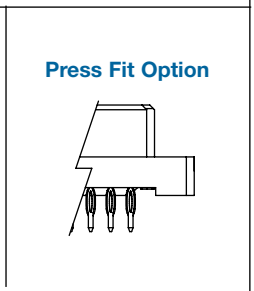
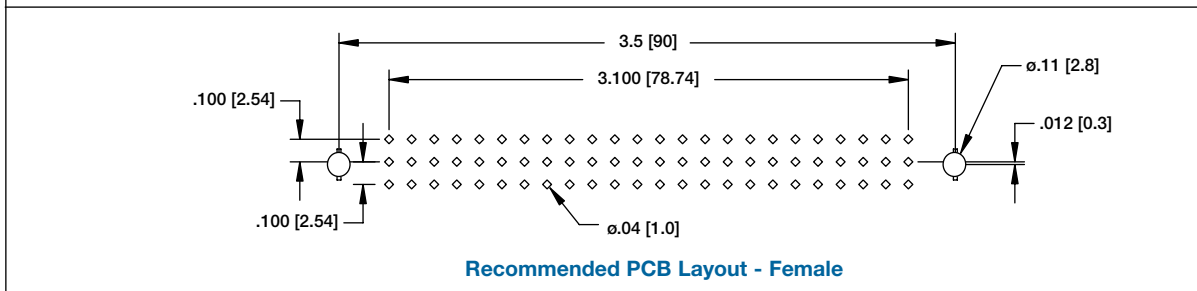
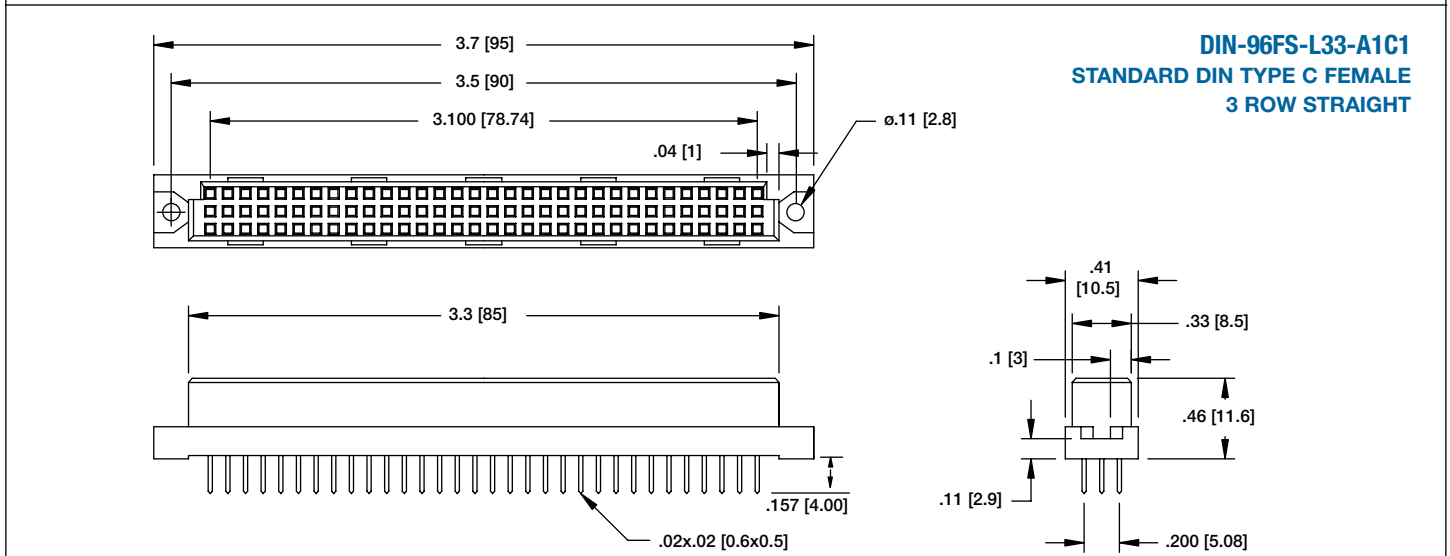
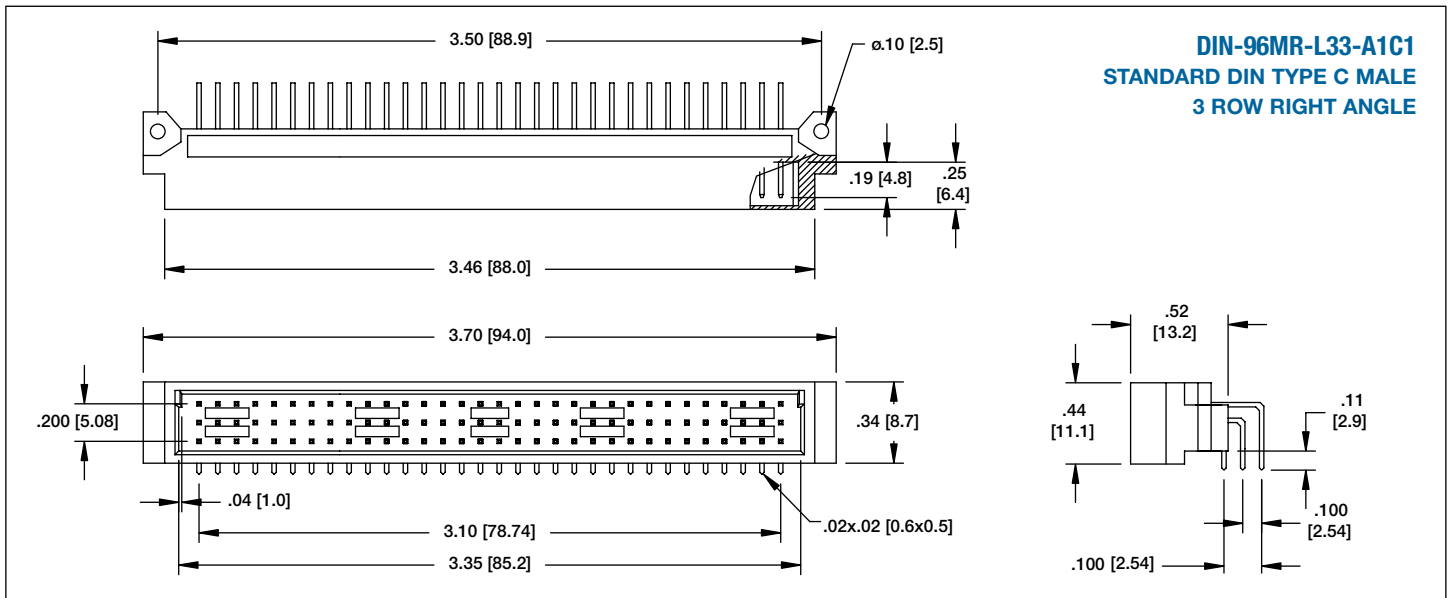

DIN 41612 CONNECTORS

INVERSE TYPE Q

DNR SERIES

DIN-64MS-L22-A1C1 INVERSE DIN TYPE Q MALE 2 ROW STRAIGHT

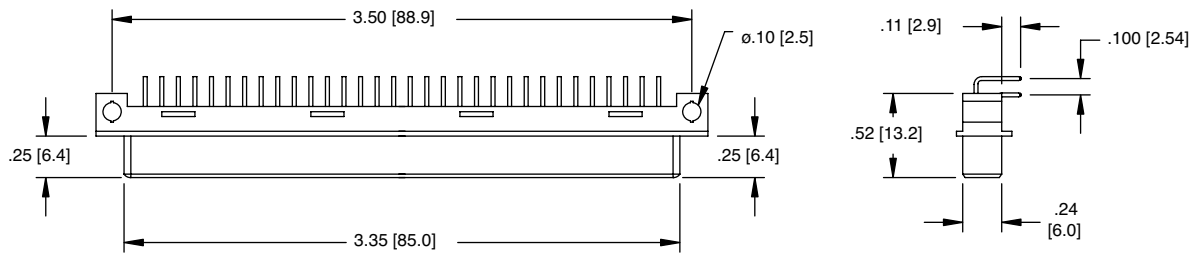
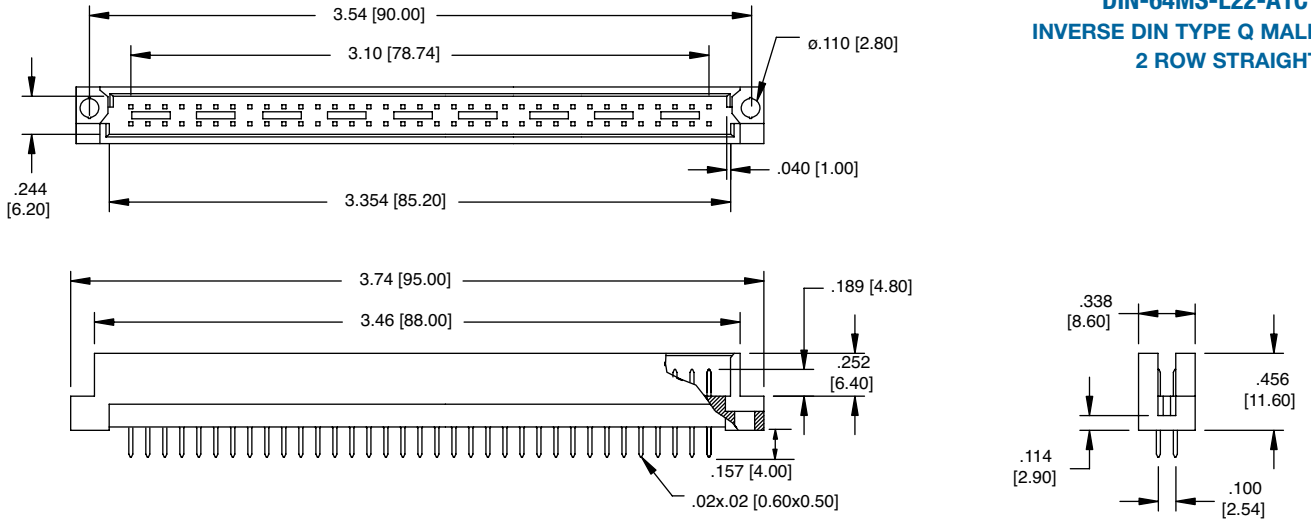

DIN-64FR-L22-A3C1 INVERSE DIN TYPE Q FEMALE 2 ROW RIGHT ANGLE

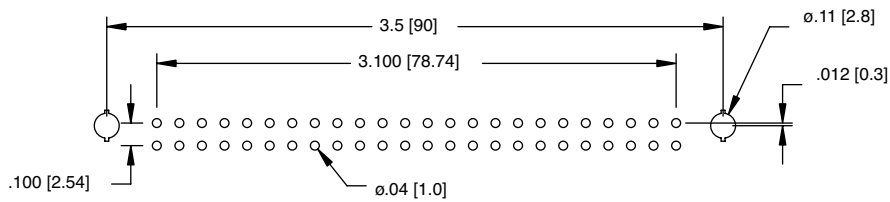

Recommended PCB Layout - Male

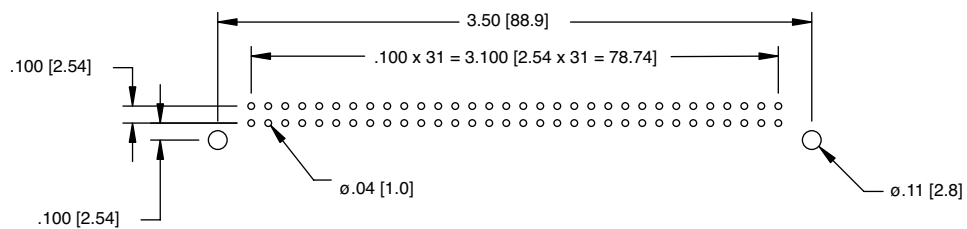

Recommended PCB Layout - Female

DIN 41612 CONNECTORS

STANDARD TYPE B

DNR SERIES

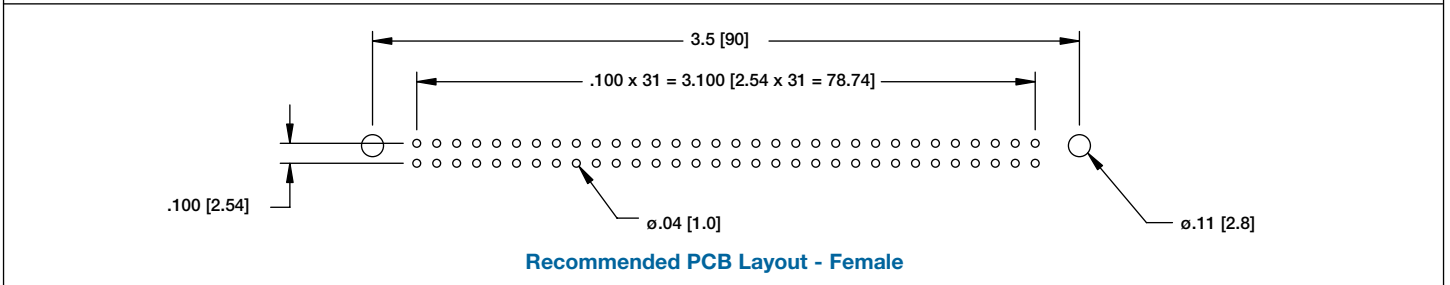
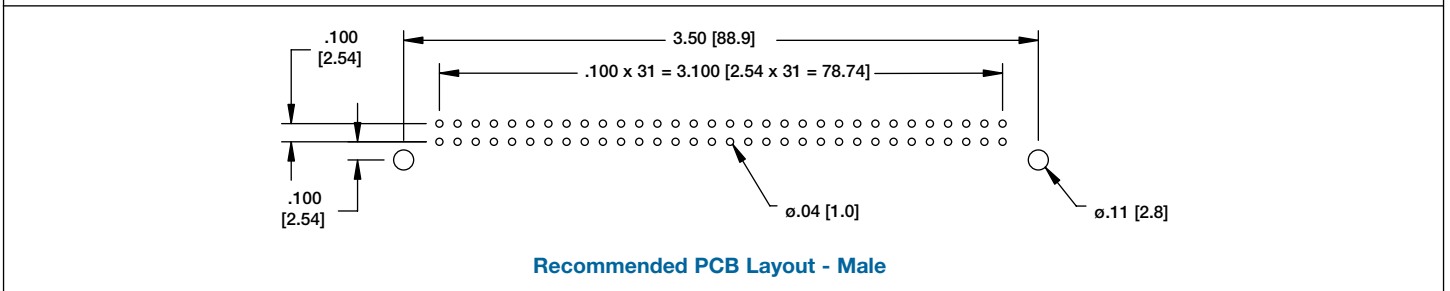
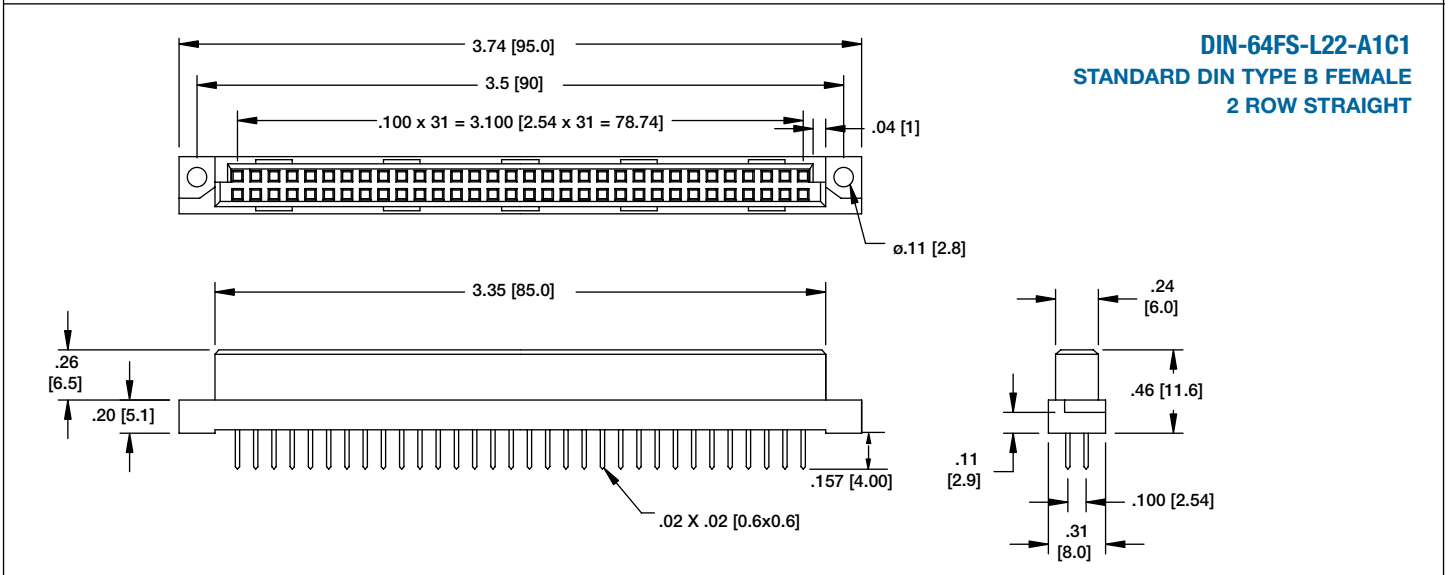
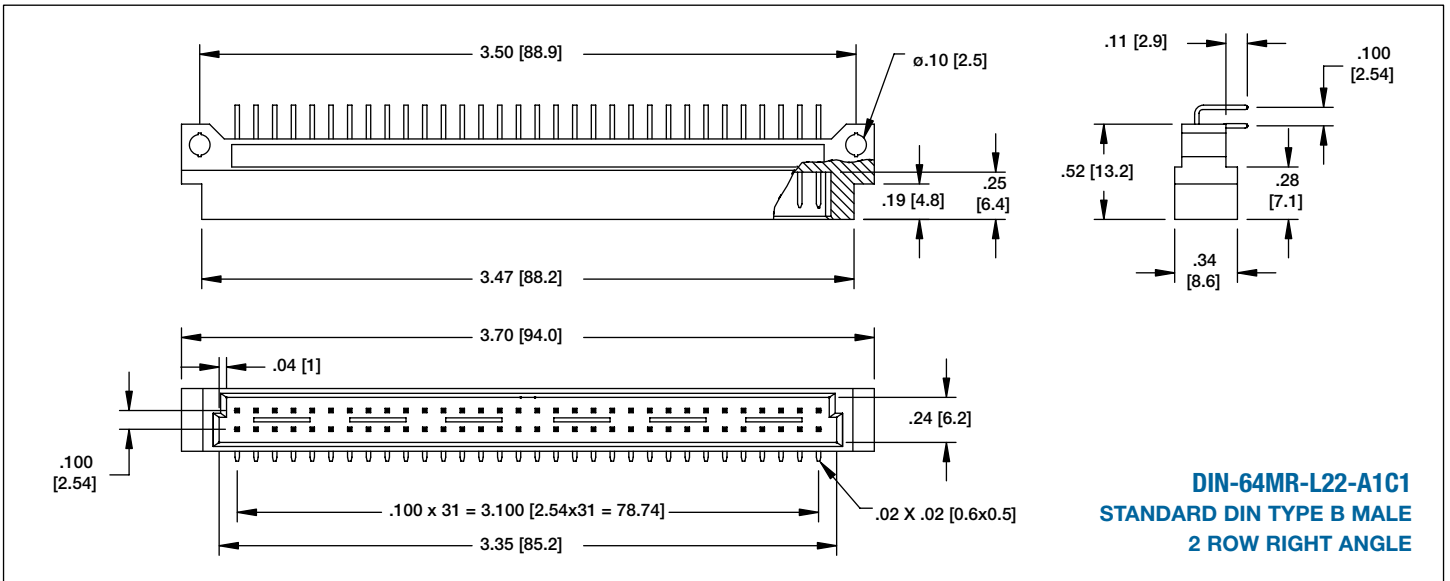

DIN 41612 CONNECTORS

INVERSE TYPE 1/2 R

DNR SERIES

DIN-48MS-S33-A1C1
INVERSE DIN TYPE 1/2 R MALE
3 ROW STRAIGHT

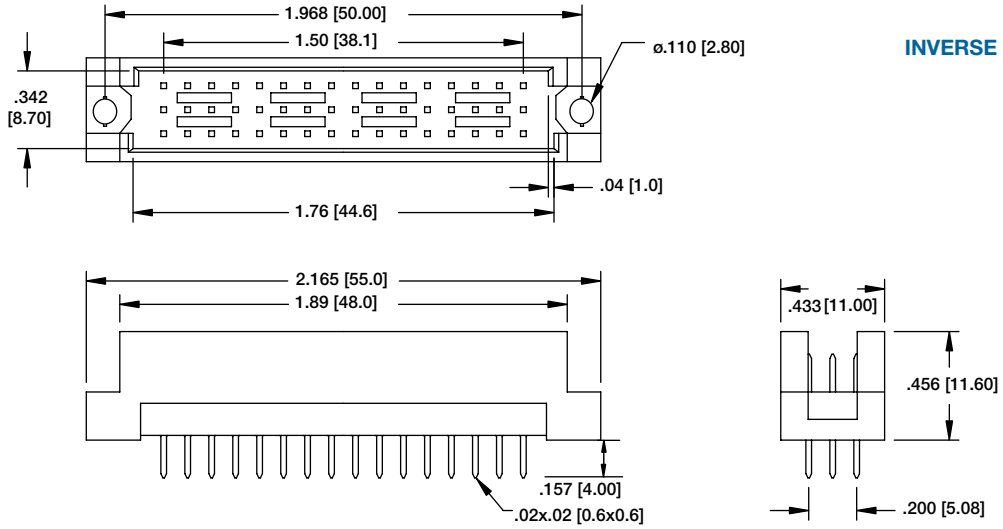

DIN-48FR-S33-A1C1
INVERSE DIN TYPE 1/2 R FEMALE
3 ROW STRAIGHT

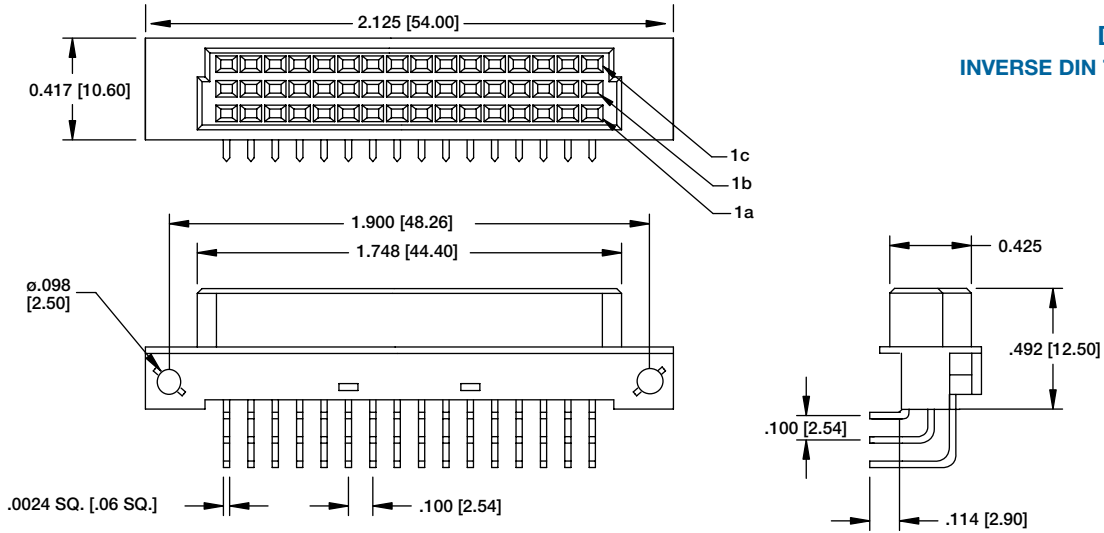

Recommended PCB Layout - Male

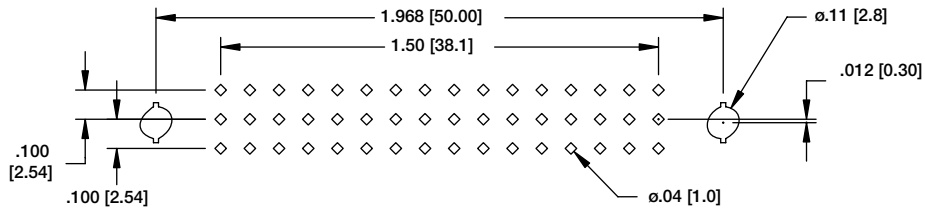

Recommended PCB Layout - Female

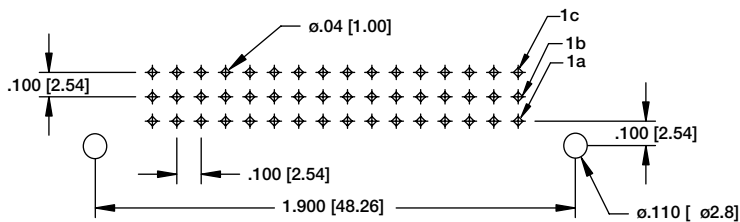

DIN 41612 CONNECTORS

STANDARD TYPE 1/2 C

DNR SERIES

DIN-48FS-S33-A1C1

STANDARD DIN TYPE 1/2 C FEMALE
3 ROW STRAIGHT

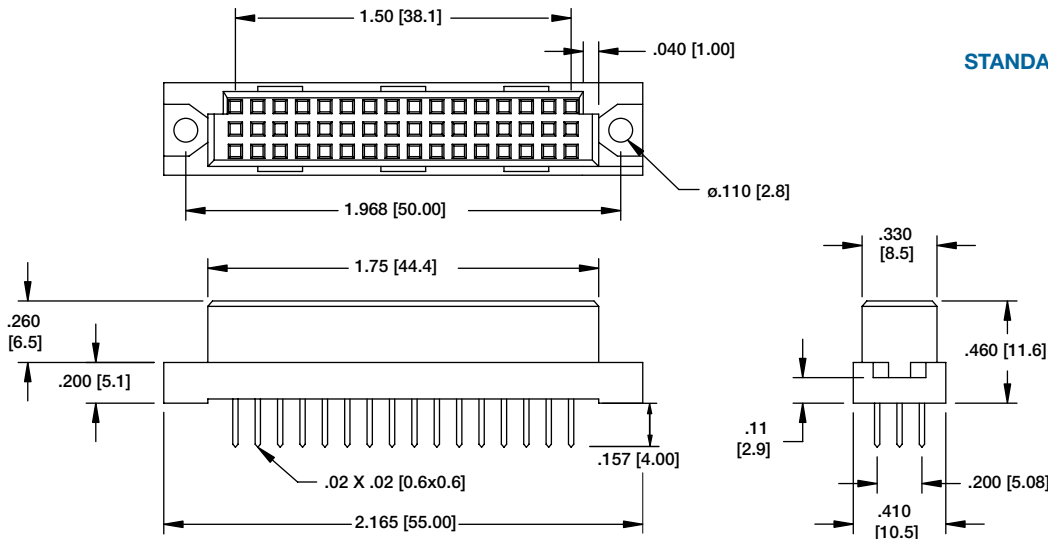

DIN-48MR-S33-A1C1

STANDARD DIN TYPE 1/2 C MALE
3 ROW RIGHT ANGLE

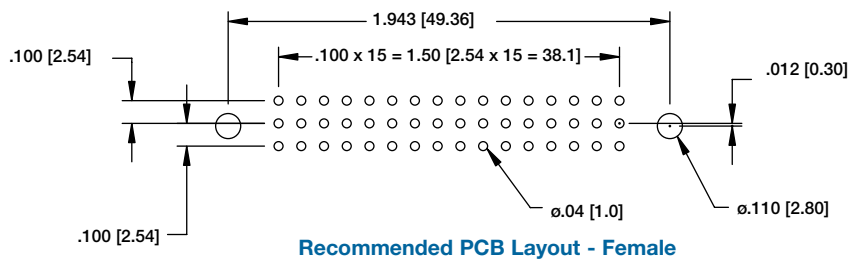
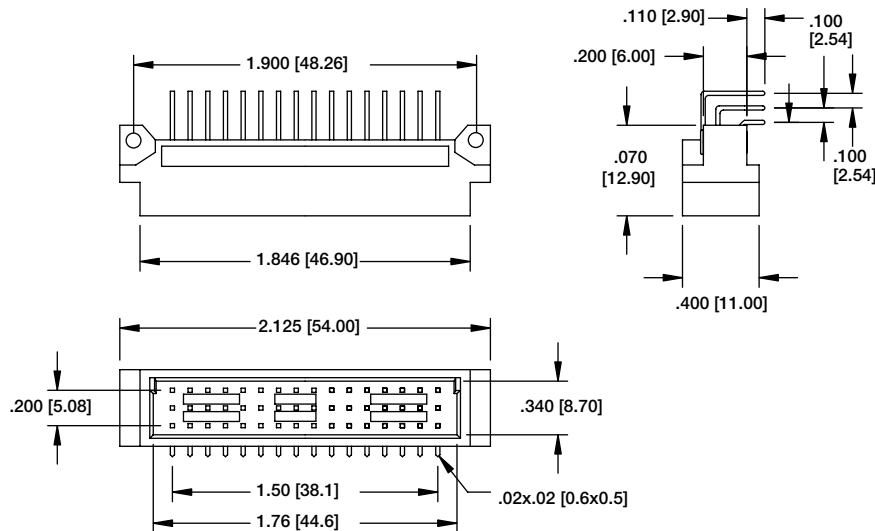

Recommended PCB Layout - Female

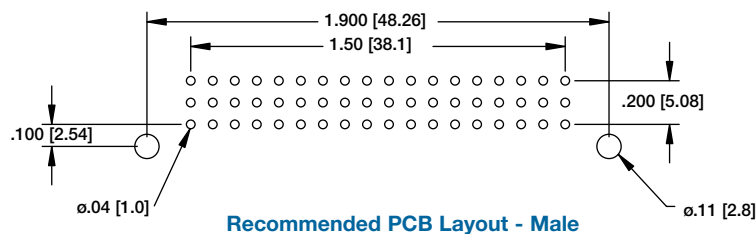

Recommended PCB Layout - Male

DIN 41612 CONNECTORS

4 ROW MALE & FEMALE

DNR SERIES

DIN-240MS-L44-A1 4 ROW MALE STRAIGHT

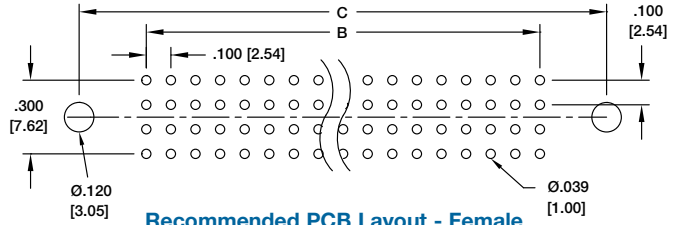
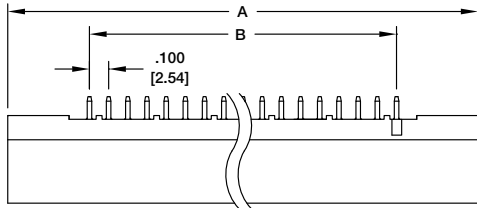

Recommended PCB Layout - Female

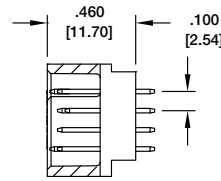
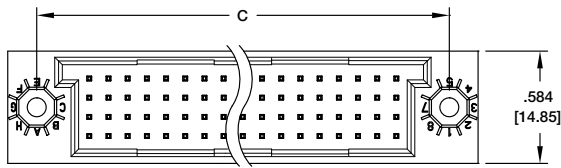

POSITIONS	DIMENSIONS		
	A	B	C
100	3.250 [82.55]	2.400 [60.96]	2.950 [74.93]
128	3.950 [100.33]	3.100 [78.74]	3.650 [92.71]
160	4.750 [120.65]	3.900 [99.06]	4.450 [113.03]
200	5.750 [146.05]	4.900 [124.46]	5.450 [138.43]
240	6.750 [171.45]	5.900 [149.86]	6.450 [163.83]

DIN-240FR-L44-A1 4 ROW FEMALE RIGHT ANGLE

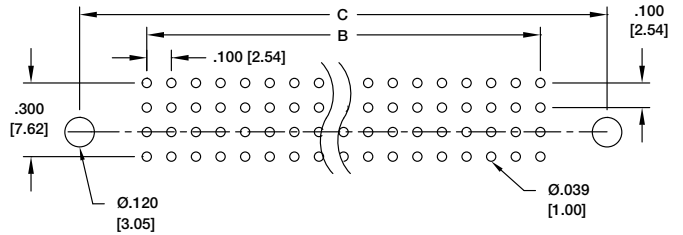
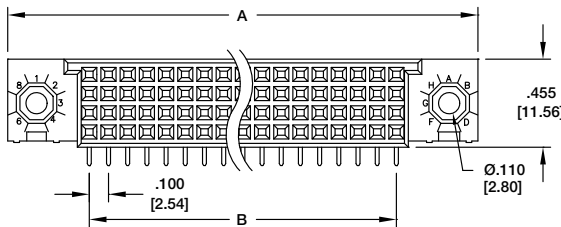

Recommended PCB Layout - Female

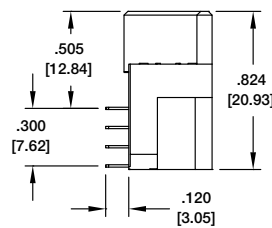
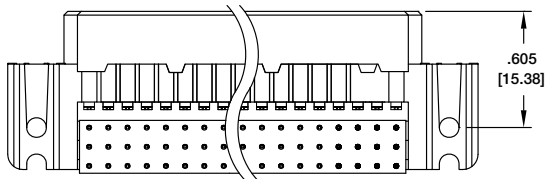

POSITIONS	DIMENSIONS		
	A	B	C
100	3.250 [82.55]	2.400 [60.96]	2.950 [74.93]
128	3.950 [100.33]	3.100 [78.74]	3.650 [92.71]
160	4.750 [120.65]	3.900 [99.06]	4.450 [113.03]
200	5.750 [146.05]	4.900 [124.46]	5.450 [138.43]
240	6.750 [171.45]	5.900 [149.86]	6.450 [163.83]