

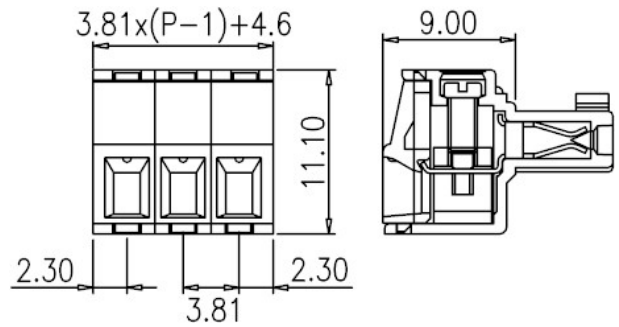

Plugs for pluggable terminal blocks / EC & ESD series



EC381V



Pitch: 3.81mm

Approval	 	
Technical Data	UL	IEC
Rated voltage	300V	320V
Rated current	8A	14A
Conductor cross-section, solid (AWG/ mm ²)	28~14 / 0.2~1.5	
Conductor cross-section, flexible (AWG/ mm ²)	28~14 / 0.2~1.5	
Rated surge voltage (UL/IEC/Max.)	1.6 / 2.5 / 3 KV	
Torque (N-m)	0.19	
Screw	M2	
Wire strip length	6~7mm	
Pole	Cat. No.	
02	EC381V-02P	
:	:	
:	:	
24	EC381V-24P	