

PC

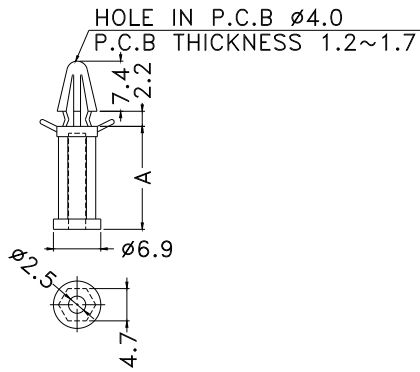
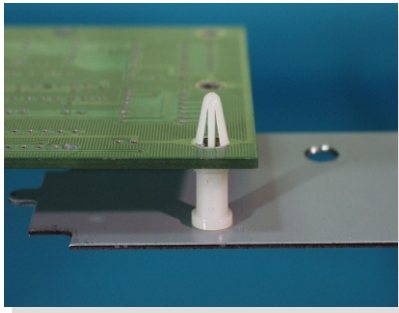

PARTNO	A	PACKAGE
TCBS-5	5.0	1000
TCBS-6	6.35	
TCBS-7	7.0	
TCBS-10	10.0	
TCBS-15	15.0	
TCBS-20	20.0	
TCBS-25	25.0	
TCBS-30	30.0	
TCBS-35	35.0	

FOR M3 SELF TAPPED SCREW

PC

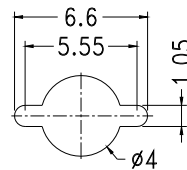
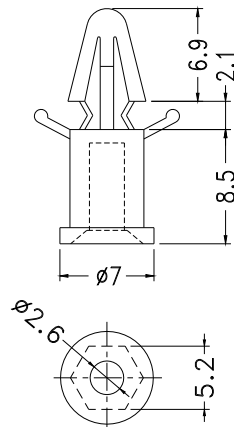
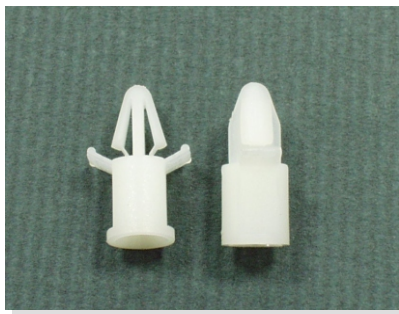

PARTNO	PACKAGE
TCBT-8.5	1000

HOLE IN PCB  
PCB THICKNESS 1.2~1.7

PC

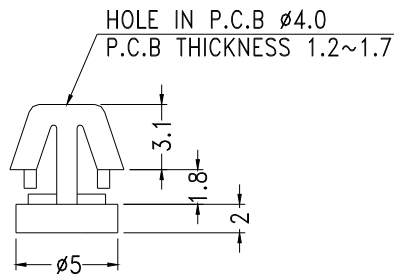

PARTNO	PACKAGE
MC-2	2000

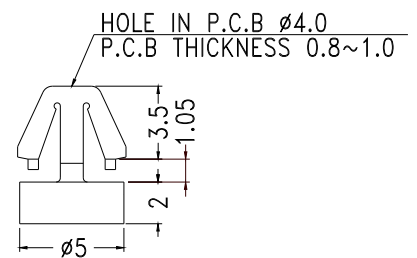

PARTNO	PACKAGE
MC-2-1.2	2000