

THIS DOCUMENT IS THE PROPERTY OF
KEYSTONE ELECTRONICS CORP. AND
SHALL NOT BE REPRODUCED, DISTRIBUTED
OR USED AS A BASIS FOR MANUFACTURE
WITHOUT PRIOR WRITTEN PERMISSION
FROM KEYSTONE ELECTRONICS CORP.

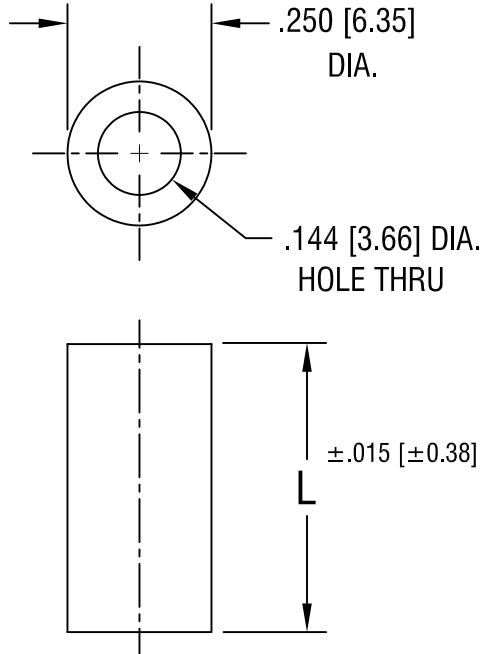

PART NO.	'L' DIM.
883	.125 [3.18]
884	.250 [6.35]
885	.375 [9.52]
886	.500 [12.70]
887	.625 [15.88]
888	.750 [19.05]
889	.875 [22.23]
890	1.000 [25.4]

KEYSTONE ELECTRONICS CORP.

ASTORIA, N.Y. 11105-2017

PART NAME

NYLON THRU-HOLE SPACER

MATERIAL

NYLON 6/6

FINISH

-

DRN BY

BOONE

DATE

2.10.98

APPD

LN

SCALE

3X

TOLERANCES

INCH [MM]

DECIMAL ± .005 [± 0.15]

ANGULAR ± 1°
UNLESS OTHERWISE SPECIFIED

CODE

C/M

DWG NO.

883-890

DATE	DESCRIPTION	REV.