

7906 Series

D-SUB Right Angle Type

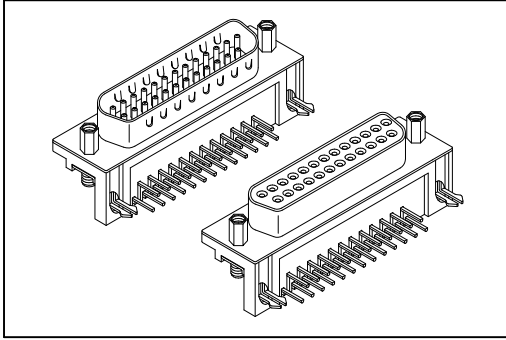

Material:

Housing: Thermoplastic Polyester Glass Filled UL94V-0.
 Contacts: Copper Alloy.
 Shell: Metal.

Electrical Characteristics:

Current Rating: 1 A.
 Dielectric Withstanding Voltage: AC 1000V.
 Insulator Resistance: 1000M Ω min.
 Contact Resistance: 30m Ω max.
 Operating Temperature: -55°C~+105°C.

Features:

Mates with: 7901, 7907, 7908.

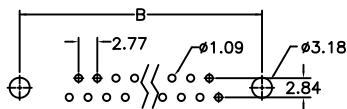
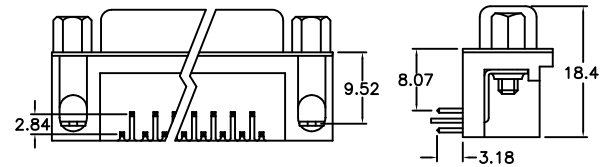
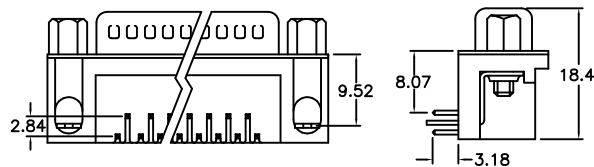
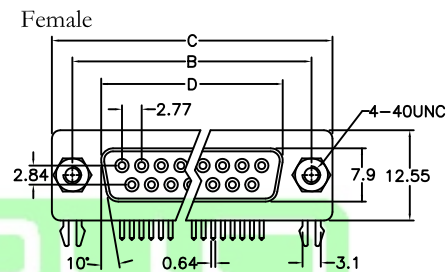
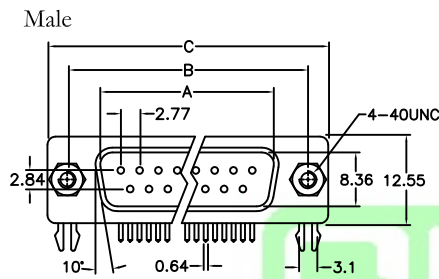

P.C. Board Layout

Position	Dimension			
	A	B	C	D
9	16.92	24.99	30.81	16.33
15	25.25	33.32	39.14	24.66
25	38.96	47.04	53.04	38.38
37	55.42	63.50	69.32	54.84

Ordering information

7906-
Series

37
Position

M
M: Male
F: Female

A
A ~ Z: See Page A152 ~ A153

A
A: Tray Package

Mounting Option

Footprint 8.07mm(0.318")



Option A

With Grounding Forks (Locking Type) and With Jack Screws Attached.

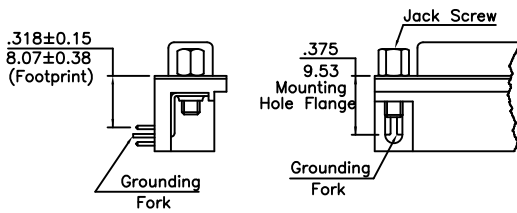

Option G

With Grounding Forks (Locking Type) and With .125 Diameter Non-threaded Riveted Inserts.

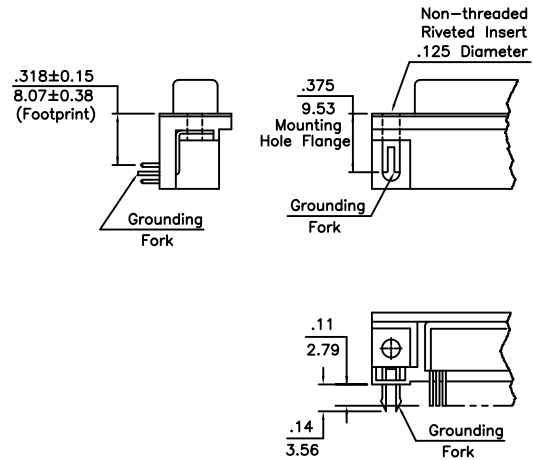

Option B

With Grounding Forks (Locking Type) and With Riveted Threaded Inserts.

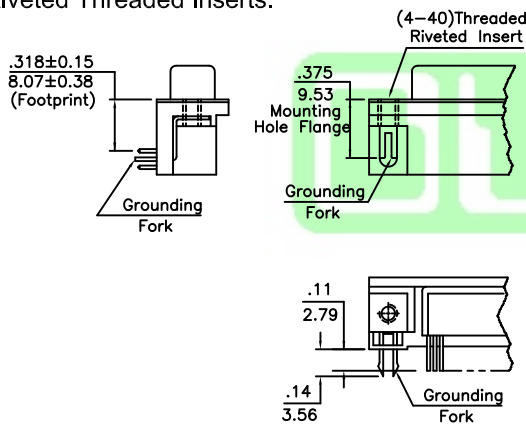

Option H1

With Riveted Threaded Inserts and With Jack Screw Attached.

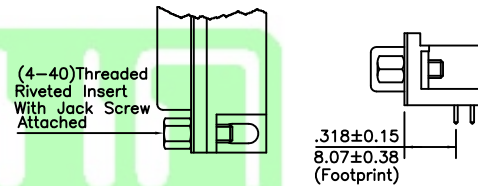

Option B1

With Riveted Threaded Inserts.

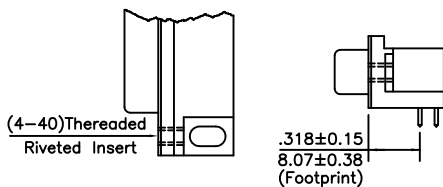

Option K

Grounding Strap With .125 Diameter Non-threaded Mounting Holes. and With Riveted Threaded Inserts.

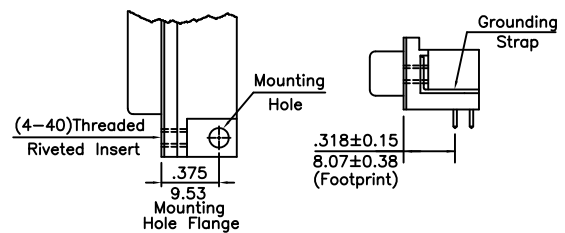

Mounting Option

Footprint 8.07mm(0.318")



Option L1

With .125 Diameter Non-threaded Mounting Holes. and With Riveted Threaded Inserts and With Jack Screws Attached.

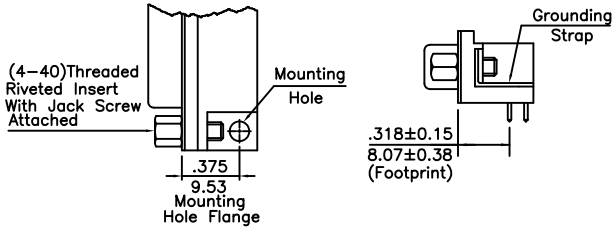

Option Y

With Grounding Forks (Locking Type) With Riveted Threaded Inserts and With Jack Screws Attached.

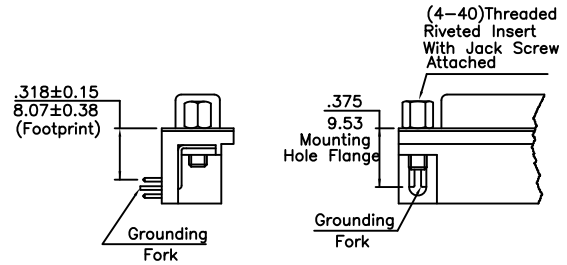

Option L

Same As Option L1, but Jack Screws Are Bagged Separately.

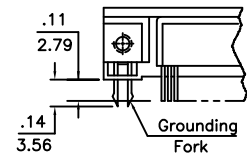
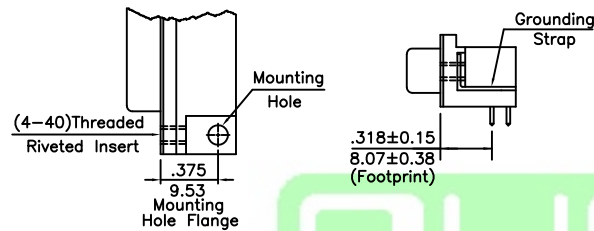

Option H

Same As Option Y, but Jack Screws Are Bagged Separately.

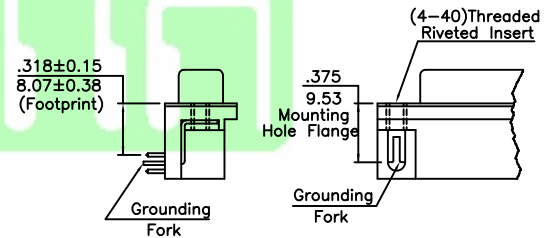
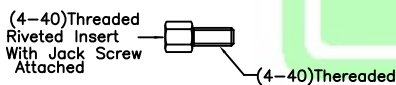

Option Q

With .130 Diameter Non-threaded Mounting Holes. and With Jack Screws Attached.

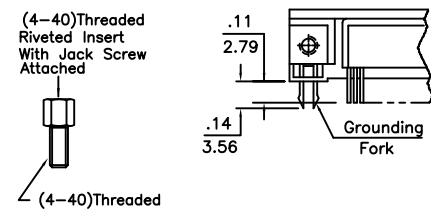
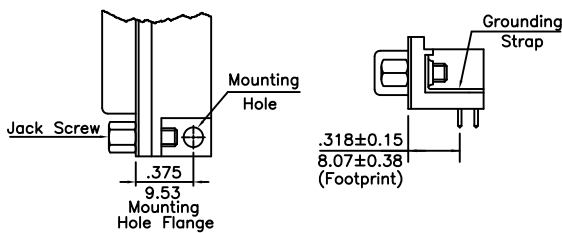

Option R

Grounding Strap With .125 Diameter Non-threaded Mounting Holes. and With .125 Diameter Non-threaded Riveted Inserts.

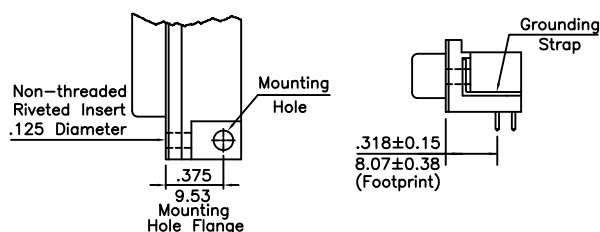

Option Z

With 4-40 Threaded Mounting Holes. and With Jack Screws Attached and With .130 Diameter Riveted Inserts.

