

# MULTILAYER TYPE

## 4 LINE CHIP ARRAY FERRITE CHIP BEAD



- Impedance Range: 60 to 1000  $\Omega$ .
- Operating Temperature Range: -55°C to +125°C.
- Soldering Method: Reflow or Wave Soldering, suitable for lead free soldering.
- Packaging Method: Tape & Reel (per EIA Specifications).
- Storage Temperature: max. 40°C, RH 70%.
- ROHS compliant.



### Features

- Combines 4 single 1608(0603) chips into one package 3216(1206) to reduce board space, and placement time.
- The 0.8mm terminal pitch for prevention of EMI in multiple lines such as connectors and IC pins.
- Material and construction design minimise cross talk between adjacent circuits.

### Application Field

- Filtering between analog and digital circuitry, clock generation circuitry, I/O interconnects, isolation between RF noisy circuits and logic devices susceptible to functional degradation, power supply filtering to prevent conducted RF energy from corrupting the power generation circuitry, high frequency EMI prevention of computers, printers, VCRs, TVs and portable telephones.

### Part Number Code

<b>MLB</b>	<b>3216S</b>	-	<b>0060</b>	<b>M4</b>	<b>F</b>
Series Name	Size Code and signal speed S=standard H= High speed		Impedance (ex.0010 =10 $\Omega$ $\pm$ 25%)	Classification (4 line array)	Rated Current
					A= 50mA    D= 150mA
					B= 80mA    E= 200mA
					C= 100mA   F= 300mA

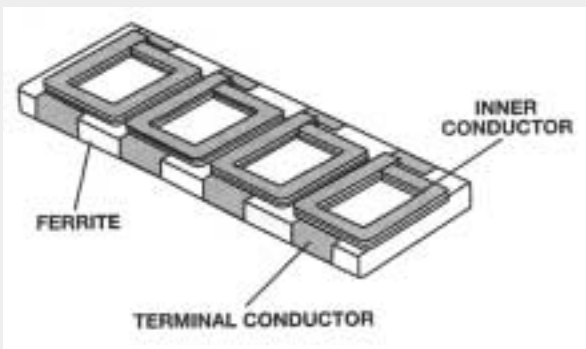

### Shape and Dimensions

Size code	Size	Length(L)	Width (W)	Thickness (T)	C1	C2	D
1206	3216	3.2 $\pm$ 0.2	1.6 $\pm$ 0.2	0.8 $\pm$ 0.1	0.45 $\pm$ 0.15	0.37 $\pm$ 0.17	0.8 $\pm$ 0.1

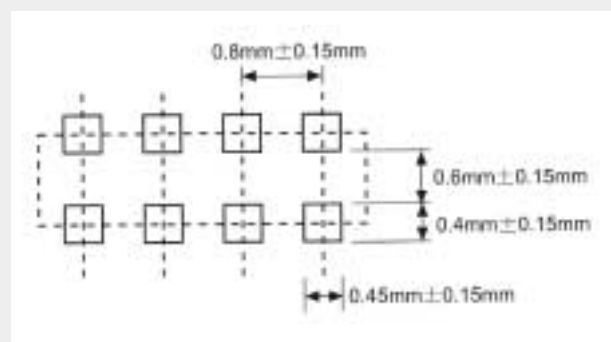
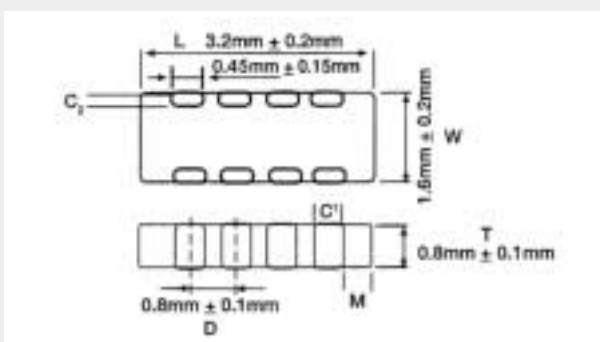

# MULTILAYER TYPE

## 4 LINE CHIP ARRAY FERRITE CHIP BEAD

### Specifications

P/N with standard rated current	Impedance (Ω) +/- 25%	Test Freq. (MHz)	DCR max.(Ω)	Standard Rated Current (mA)	Signal speed	Rated Current Selection Chart (mA)					
						A	B	C	D	E	F
<b>MLB-3216S-0060M4F</b>	60	100	0.120	300	Standard	50	80	100	150	200	300
<b>MLB-3216S-0120M4D</b>	120	100	0.200	150	Standard	50	80	100	<b>150</b>	-	-
<b>MLB-3216S-0300M4E</b>	300	100	0.400	200	Standard	50	80	100	150	<b>200</b>	-
<b>MLB-3216S-0600M4C</b>	600	100	0.600	100	Standard	50	80	<b>100</b>	-	-	-
<b>MLB-3216S-1000M4A</b>	1000	100	0.800	50	Standard	<b>50</b>	-	-	-	-	-

**150** Standard rated current  
100 available option

# MULTILAYER TYPE

## 4 LINE CHIP ARRAY FERRITE CHIP BEAD

**MLB-3216S-0060M4F**

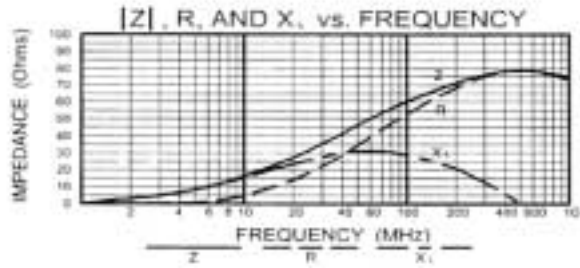

**MLB-3216S-0120M4D**

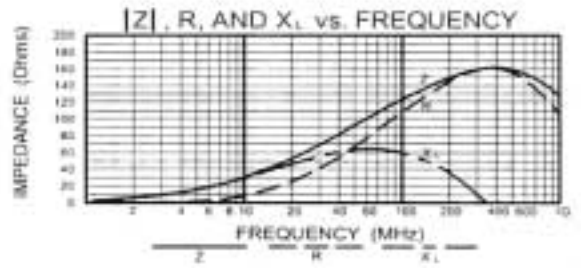

**MLB-3216S-0300M4E**

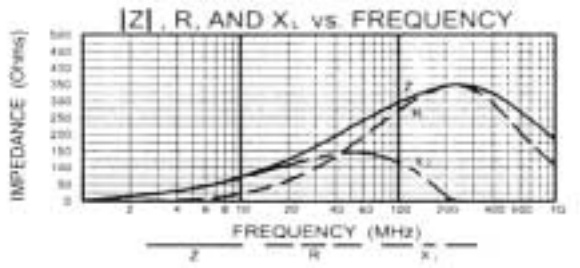

**MLB-3216S-0600M4C**

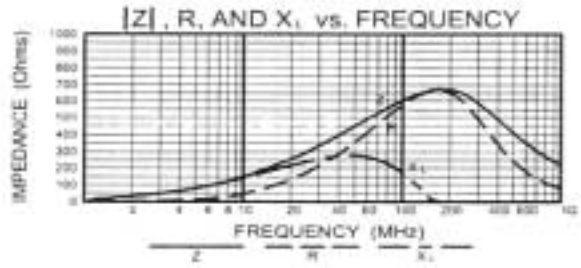

**MLB-3216S-1000M4A**

