

WIW1028(3386)

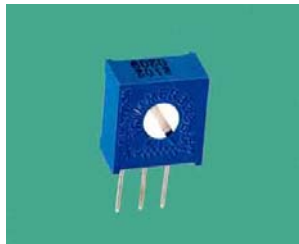

WIW1028(3386)-C

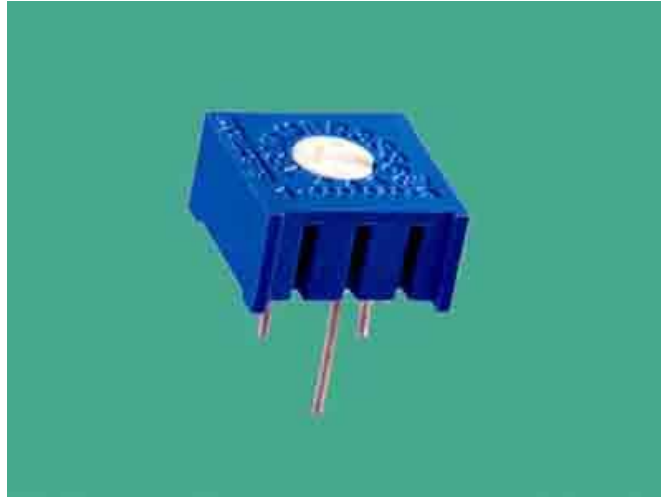
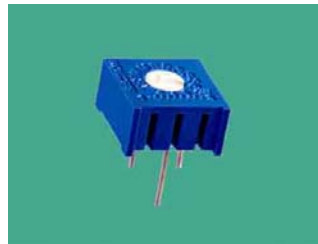

WIW1028(3386)-F

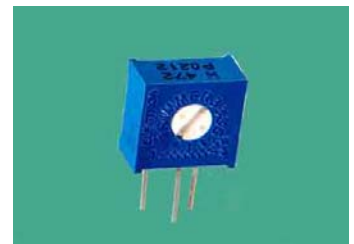

WIW1028(3386)-H

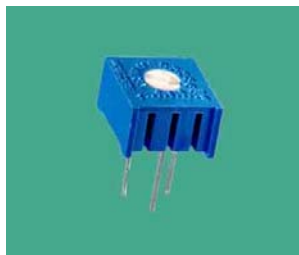

WIW1028(3386)-P

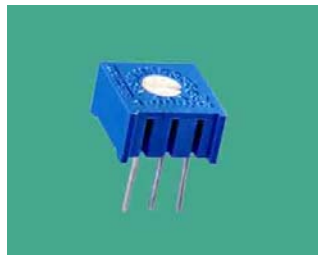

WIW1028(3386)-R

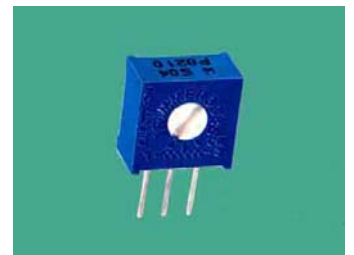

WIW1028(3386)-W

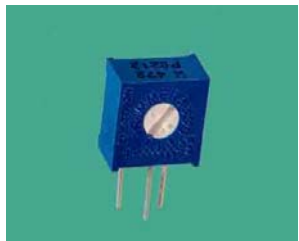

WIW1028(3386)-X



WIW1028(3386)-Y



WIW1028(3386)-blue knob

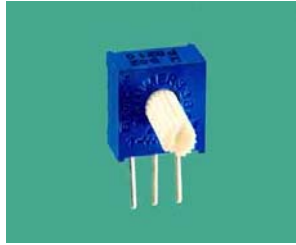

WIW1028(3386)R-C



WIW1028(3386)R-F

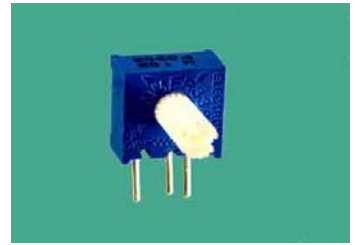

WIW1028(3386)R-H

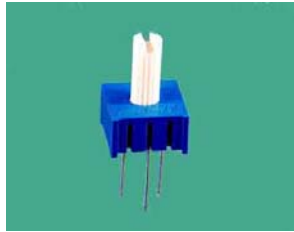

WIW1028(3386)R-P

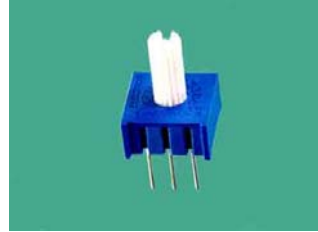

WIW1028(3386)R-R

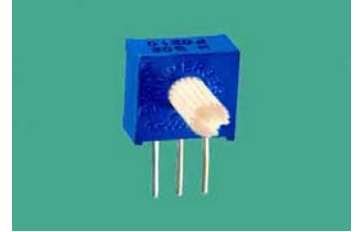

WIW1028(3386)R-W



WIW1028(3386)R-X

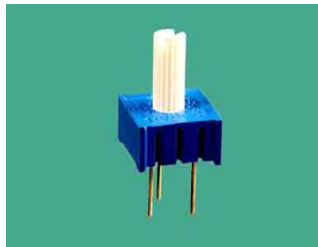

WIW1028(3386)R-Y

WIW1028(3386) – Trimmer®**Square Trimming Potentiometer****Features**

Single Turn / Cermet / Industrial / Sealed

Available with a knob for finger adjust

Available with extended shaft

Top and side adjust types (F,P,H,W,X most popular)

Electrical Characteristics

Standard Resistance Range	100 to 2 megohms (see standard resistance table)
Resistance Tolerance	±10% std. (tighter tolerance available)
Absolute Minimum Resistance	1% or 2 ohms max. (whichever is greater)
Contact Resistance Variation	3% or 3 ohms max. (whichever is greater)
Adjustability	Voltage ±0.05% Resistance ±0.15%
Resolution	Infinite
Insulation Resistance	500 vdc 1,000 megohms min.
Dielectric Strength	101.3 kPa 500 vac 8.5 kPa 350 vac
Adjustment Angle	260° nom.

Environmental Characteristics

Power Rating (250 volts max.)	0.5 watt (70°C), 0 watt (125°C)
Temperature Range	-55°C to +125°C
Temperature Coefficient	±100ppm/°C
Vibration	98 m/s ² (1% Δ TR; 1% Δ VR)
Shock	490 m/s ² (1% Δ TR; 1% Δ VR)
Load Life	1,000 hours 0.5 watt @ 70°C (3% Δ TR; 4% or 4 ohms, Whichever is greater, CRV)
Rotational Life	200 cycles (3% Δ TR; 4% or 4 ohms, Whichever is greater, CRV)

Physical Characteristics

Mechanical Angle	280° nom.
Torque	20 mN · m max.
Stop Strength	50 mN · m min.
Terminals	Solderable pins
Standard Packaging	50 pcs. per tube

Common Dimensions Top Adjust

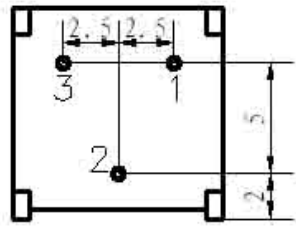
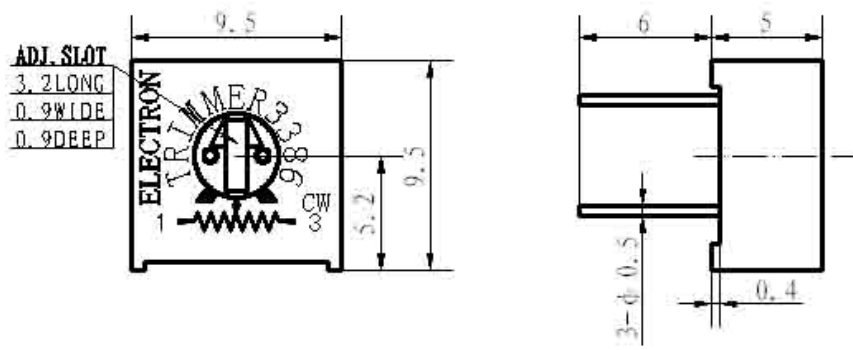

F

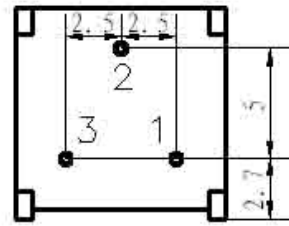

Y

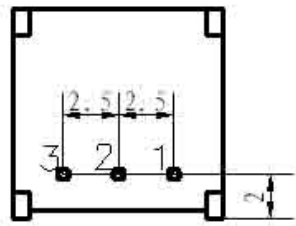

R

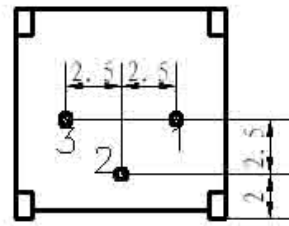

P

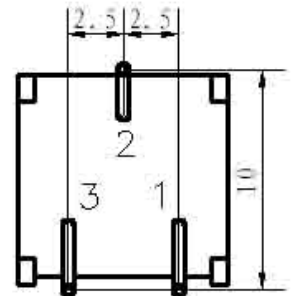

G

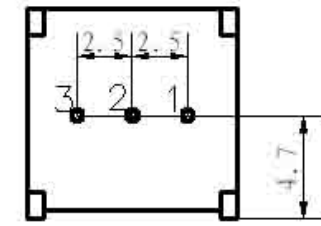

U

Common Dimensions Side Adjust

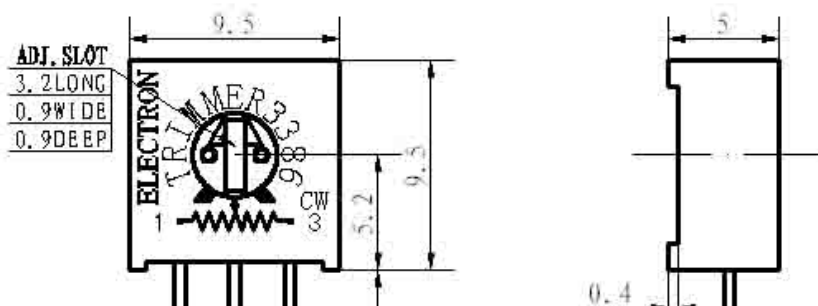

WIW1028(3386)(with knob) Dimensions

Common Dimensions
Top Adjust

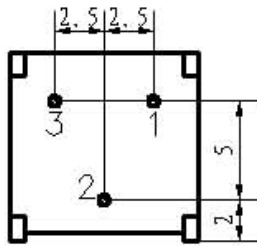
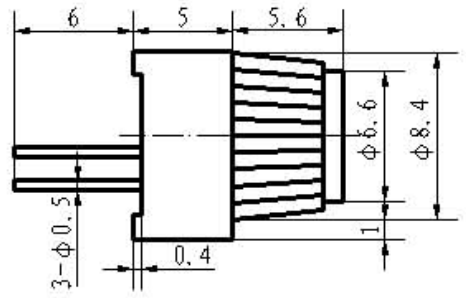
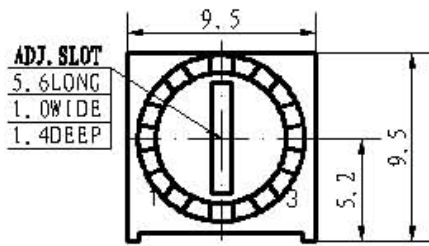

F(with knob)

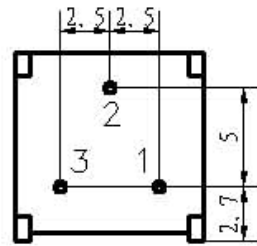

Y(with knob)

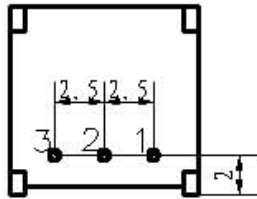

R(with knob)

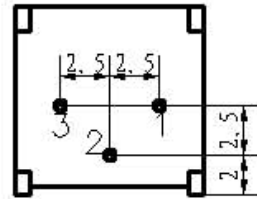

P(with knob)

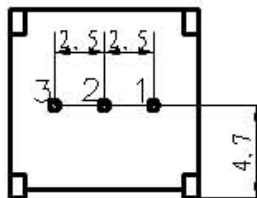

U(with knob)

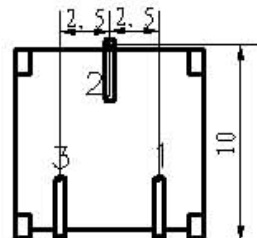

G(with knob)

Common Dimensions
Side Adjust

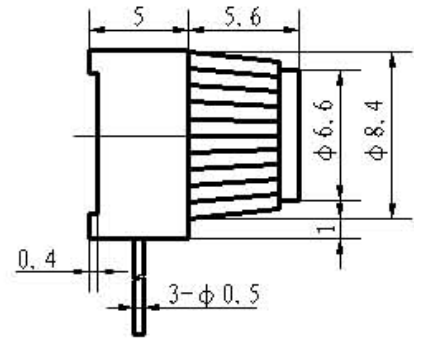
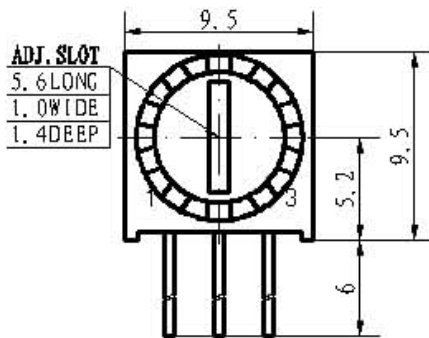

WIW1028(3386)(with shaft) Dimensions

Common Dimensions
Top Adjust

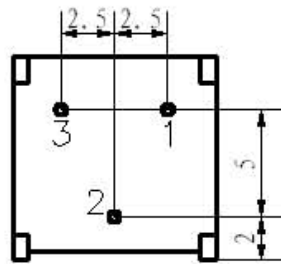
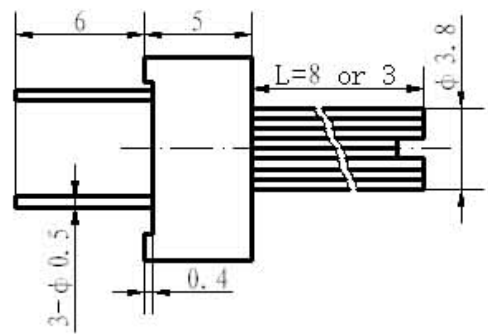
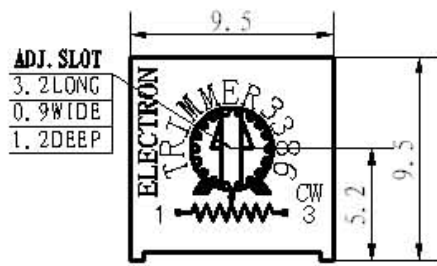

F(with shaft)

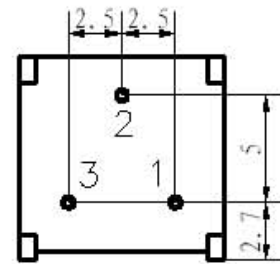

Y(with shaft)

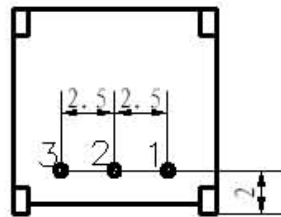

R(with shaft)

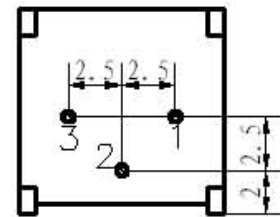

P(with shaft)

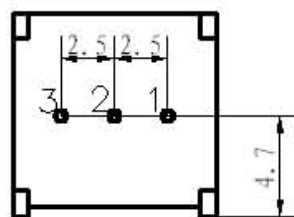

U(with shaft)

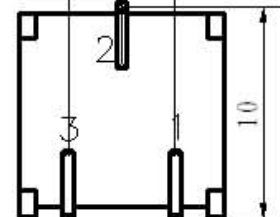

G(with shaft)

Common Dimensions
Side Adjust

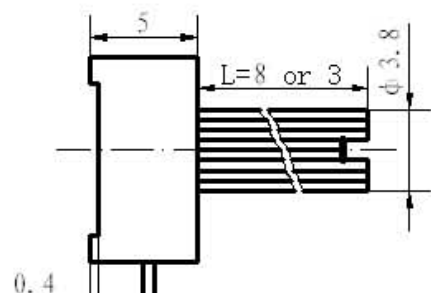
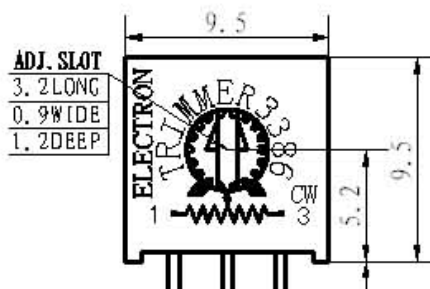

How to order

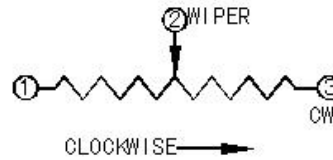
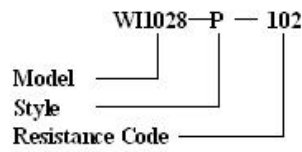

standard Resistance Table

Resistance (Ohms)	Resistance Code
100	101
200	201
500	501
1,000	102
2,000	202
5,000	502
10,000	103
20,000	203
25,000	253
50,000	503
100,000	104
200,000	204
250,000	254
500,000	504
1,000,000	105
2,000,000	205

Special resistance available

Detail Specification: Q/R Y259A-2002

Military Detail Specification: Q/R Y20011-97