

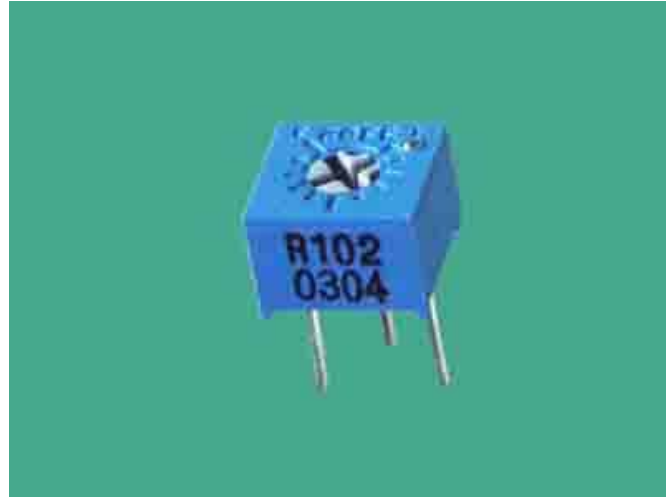

WIW3362



WIW 3362 – Trimmer **Square Trimming Potentiometer****Features**

Single Turn / Cermet / Industrial / Sealed

Available with a knob for finger adjust

Available with extended shaft

Top and side adjust types (P, U, W, S most popular)

Electrical Characteristics

Standard Resistance Range 100 to 2 megohms(see standard resistance table)

Resistance Tolerance $\pm 10\%$ std.(tighter tolerance available)

Absolute Minimum Resistance 1% or 2 ohms max.(whichever is greater)

Contact Resistance Variation 3% or 3 ohms max.(whichever is greater)

Adjustability Voltage $\pm 0.05\%$ Resistance $\pm 0.15\%$

Resolution Infinite

Insulation Resistance 500 vdc 1,000 megohms min.

Dielectric Strength 101.3 kPa 500 vac 8.5 kPa 315 vac

Adjustment Angle 210° nom

Environmental Characteristics

Power Rating (250 volts max.) 0.5 watt (70°C) , 0 watt (125°C)

Temperature Range -55°C to +125°C

Temperature Coefficient $\pm 100\text{ppm}/^\circ\text{C}$ Vibration (10to2000HZ) 98 m/s²(1% Δ TR, 2% Δ VR)Shock 390 m/s²(1% Δ TR, 2% Δ VR)

Load Life 1,000 hours 0.5 watt @ 70°C

(3% Δ TR; 4% or 4 ohm, Whichever is greater , CRV)Rotational Life 200 cycles(3% Δ TR; 4% or 4 ohm, Whichever is greater , CRV)**Physical Characteristics**

Mechanical Angle 250° nom

Torque 20 mN • m max.

Stop Strength 50 mN • m min.

Terminals Solderable pins

Standard Packaging 50 pcs. per tube

Common Dimensions Top Adjust

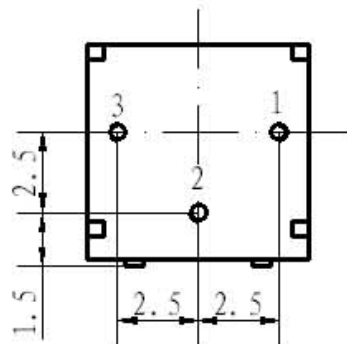
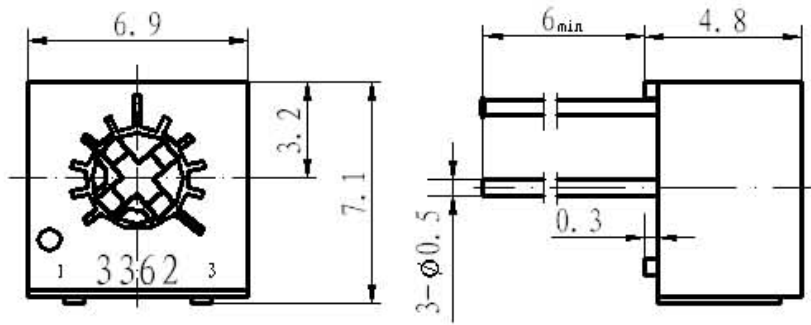

WIW3362-R

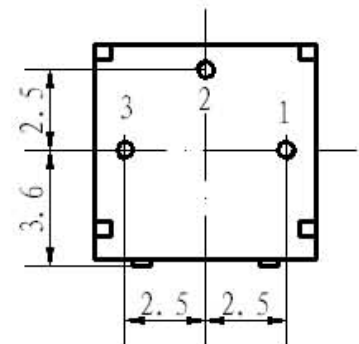

WIW3362-P

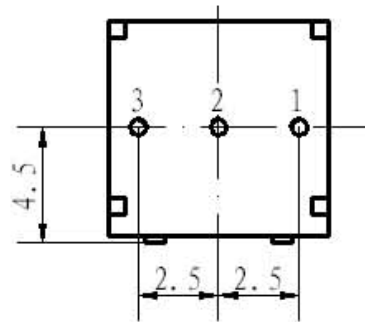

WIW3362-U

Common Dimensions Side Adjust

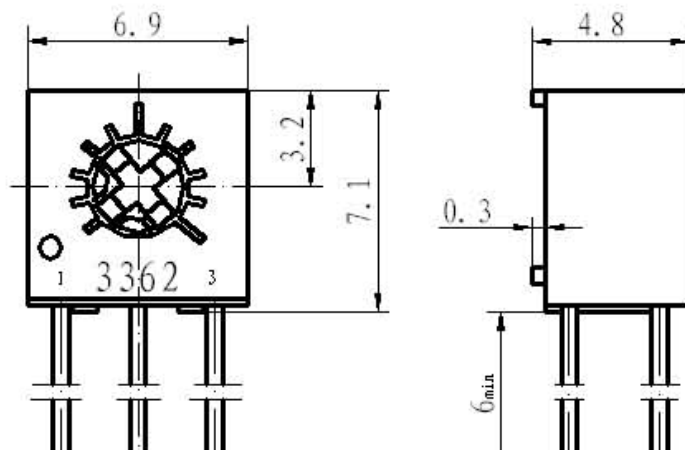

How to order

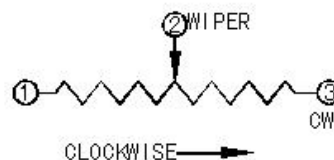
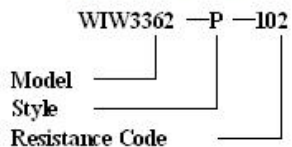

standard Resistance Table

Resistance (Ohms)	Resistance Code
100	101
200	201
500	501
1,000	102
2,000	202
5,000	502
10,000	103
20,000	203
25,000	253
50,000	503
100,000	104
200,000	204
250,000	254
500,000	504
1,000,000	105
2,000,000	205

Special resistance available
Detail Specification: Q/R/Y 260-2000

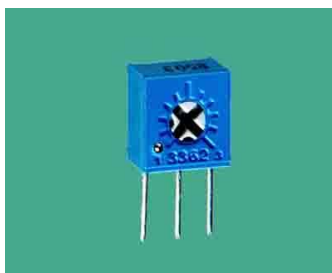

WIW3362-M

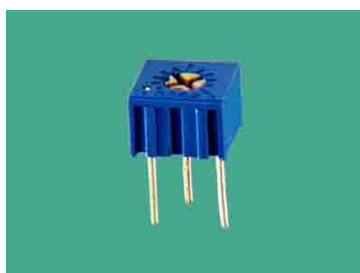

WIW3362-P

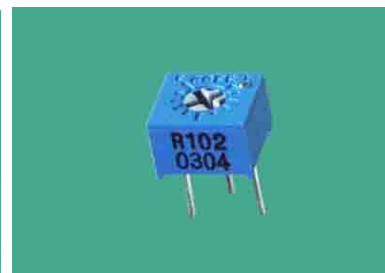

WIW3362-R

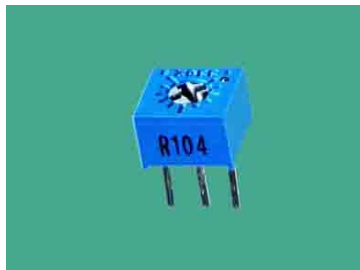
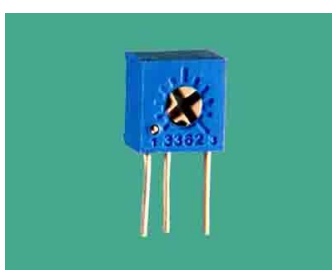

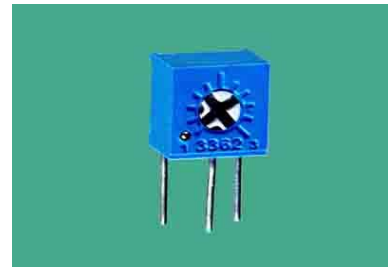

WIW3362-W

WIW3362-S

WIW3362-U

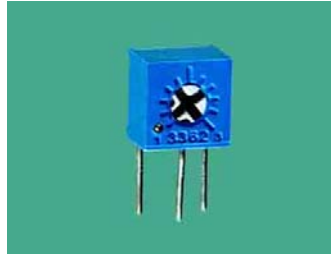

WIW3362-M反

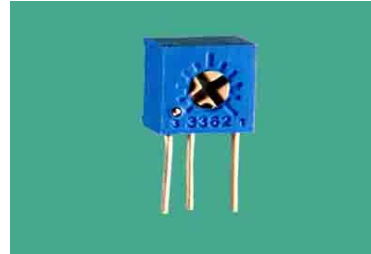

WIW3362-S反