

Magnetic Buzzer

SMB05 series

DIMENSIONS

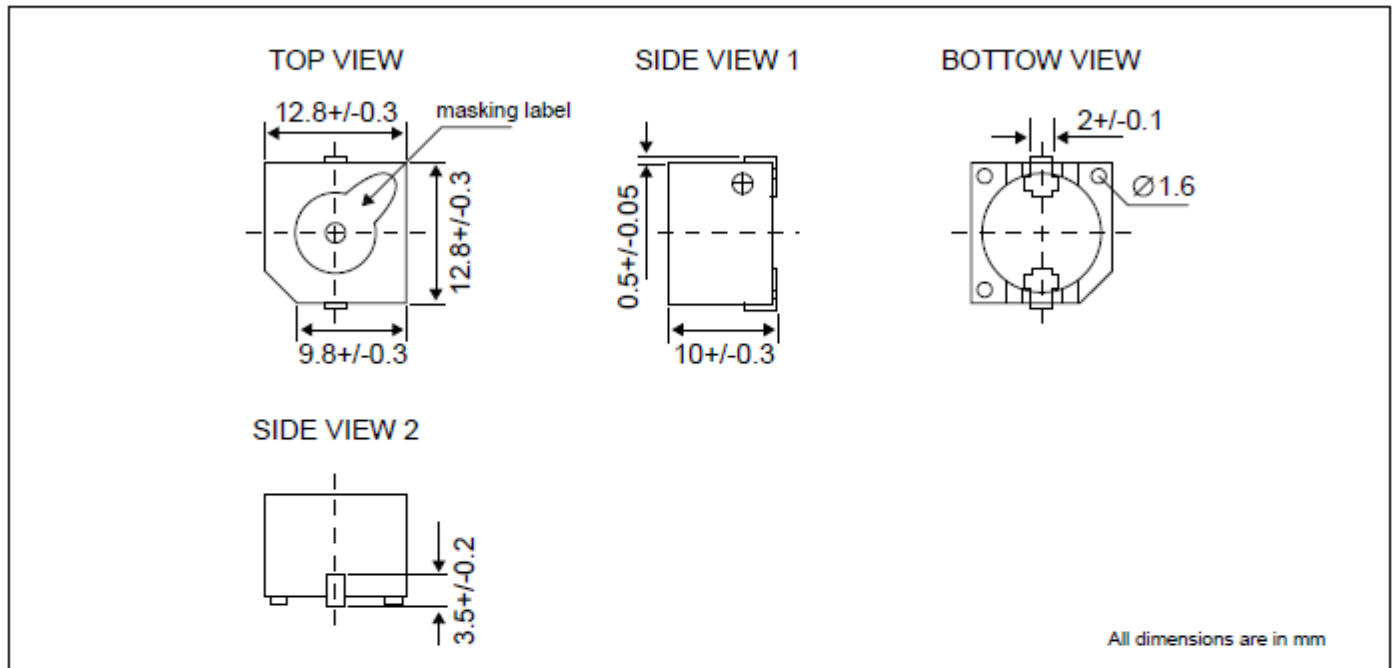

Ref. no.: CS070

Special Description : MB05A5PS to fulfil RoHS regulation, (Lead Free version)
Kapton label

ELECTRICAL SPECIFICATIONS

Model No.		MB05-A5PSR
Operating Voltage	[VDC]	4 ~ 7
Rated Voltage	[VDC]	5
* Max. Rated Current	[mA]	20
* Min. Sound Output	[dBA /10cm]	85
* Frequency	[Hz]	2300 +/- 300
Tone Nature		Single
Operating Temperature	[°C]	-40 ~ +85
Terminal		SMD
Housing Material		PPS (Pb free version)
Colour		Grey
Weight	[gm]	2