

CDM/CDH SERIES

DIP

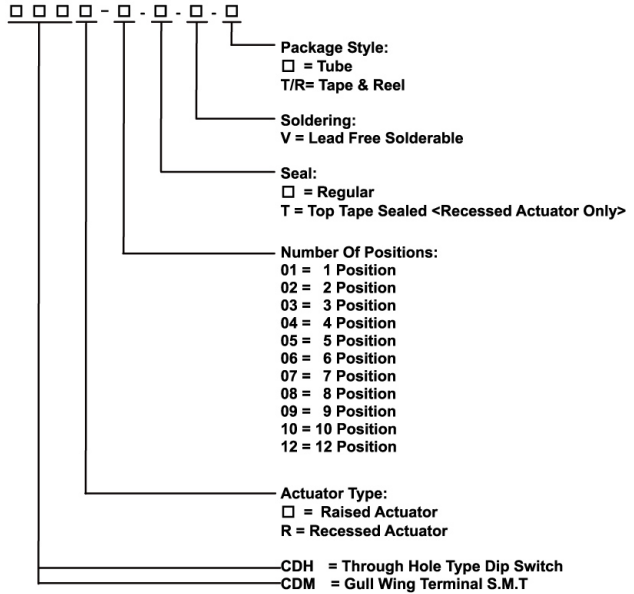

HOW TO ORDER



TACT

SPECIFICATIONS

- Mechanical life:2000 operations per switch
- Operation Force:1000gf max.
- Stroke :1.0mm
- Operation Temp:-20°C to 70°C
- Electrical life:2000 operations per switch-24 VDC, 25mA
- Contact Resistance:100m max. at initial
- Non-Switching Rating:100mA, 50VDC
- Switching Rating:25mA, 24VDC
- Circuit:Single pole single throw

LED TACT

PUSH BUTTON

TOGGLE

CDM SERIES SLIDE TYPE

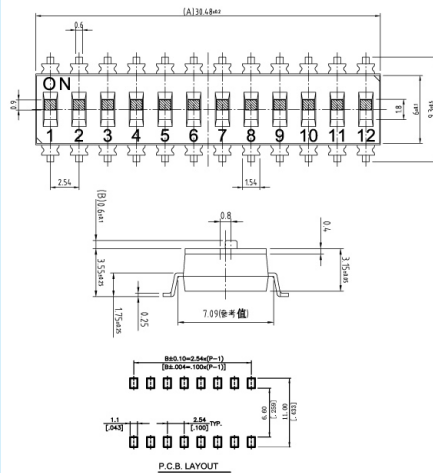
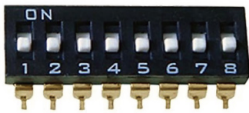

MODEL NO.	NO. POS	A
CDM-02	2	2.54
CDM-03	3	5.08
CDM-04	4	7.62
CDM-05	5	10.16
CDM-06	6	12.70
CDM-07	7	15.24
CDM-08	8	17.78
CDM-09	9	20.32
CDM-10	10	22.86
CDM-12	12	25.40

Schematic(TYP.)

 (2,3,4,5,6,7,8,9,10,12, POS AVAIL)

SLIDE

CONTACT SYSTEM

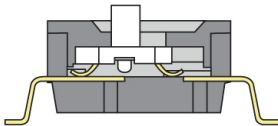

ROCKER

CDH SERIES SLIDE TYPE

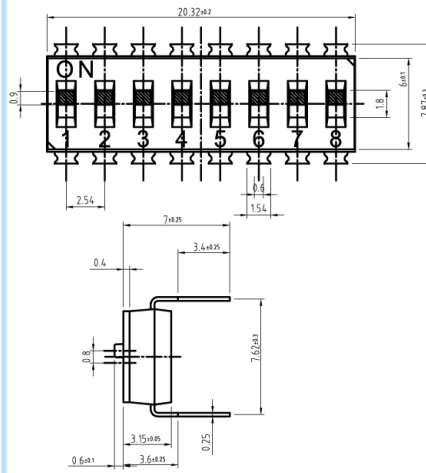
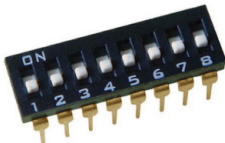

MODEL NO.	NO. POS	A
CDH-02	2	2.54
CDH-03	3	5.08
CDH-04	4	7.62
CDH-05	5	10.16
CDH-06	6	12.70
CDH-07	7	15.24
CDH-08	8	17.78
CDH-09	9	20.32
CDH-10	10	22.86
CDH-12	12	25.40

Schematic(TYP.)

 (2,3,4,5,6,7,8,9,10,12, POS AVAIL)

MICRO / POWER

CONTACT SYSTEM

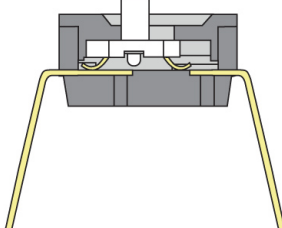

X-ON Electronics

Largest Supplier of Electrical and Electronic Components

Click to view similar products for [DIP Switches/SIP Switches](#) category:

Click to view products by [CHA](#) manufacturer:

Other Similar products are found below :

[79B10T](#) [8136-475G4T](#) [G7G-1A2-CB-DC12](#) [H7CZL8AC100240](#) [DRR60016](#) [DRS4016](#) [1825444-1](#) [200183](#) [206002](#) [25.350.0653.0](#) [SBS](#)
[5004 TG](#) [SDA10H1BDA](#) [97R06ST](#) [A2C-2A5](#) [1825444-7](#) [ADE08SA04](#) [ADE12S04](#) [192960010](#) [206005RAS](#) [206007](#) [2-1825058-8](#)
[25.330.0653.1](#) [25.352.0353.0](#) [CXDRIVEV2X](#) [IKN0600000](#) [IKN0800000](#) [LA2-002-DC24](#) [DSR02T](#) [DSS 208 N](#) [E2FMX2D1M1TGJ03M](#)
[NDI10H](#) [219-9MSTP](#) [EPM02FV](#) [206010RAST](#) [NDS08V](#) [76SB05](#) [TD06H0SK1](#) [Z7.255.9027.0](#) [1-1825058-3](#) [1825428-4](#) [219-10LPSTF](#)
[E3ZG6111D03M](#) [G4D212PUSTV2DC5](#) [EPG301BT06](#) [219-7LPSTRF](#) [1-1825058-6](#) [E3TSL23M5J03M](#) [Y5795](#) [7R0060](#) [1977208-4](#)