

承认书 (APPROVAL SHEET)

品名 PART NAME	METALLIZED POLYPROPYLENE FILM CAPACITOR (MPP-QP)
承认规格 APPROVE ITEM	CBB 盒装系列
全鹏料号 CHAMPION PART NO	
客户名称 CUSTOMER	立创商城
客户料号 PART NO	
送样承认日期 DATE	2018.08.24

承认印
APPROVAL STAMP

供应商 VENDER	客 户 CUSTOMER
东莞市全鹏电子科技有限公司 联系人: 孟总 联系电话: 13802879698 东莞市茶山镇卢边恒兴昌工业园 B 栋 4 楼 TEL:0769-86862908 FAX:0769-86862918 www.champion-dg.com	



文件名称

MPP Approval Sheet-QP
(MPP-TYPE Metallized Polypropylene
Film Interference Suppression Capacitor)

文件编号

QP-AP-28

页码

07/01

1. Scope:

This specification applied to capacitor for type MPP (Metallized Polypropylene Film Capacitor)

2. Operation Temperature:

-40°C ~ +105°C

3. Capacitance Range:

0.001uF ~ 15 uF

4. Capacitance Tolerance:

±2%(G)、±3%(I)、±5%(J)、±10%(K)、±20%(M)

5. Rated Voltage:

50VDC、63VDC、100VDC、250VDC、400VDC、450VDC、630VDC、1KVDC

6. champion Part No.:

□□□

1

(tape)

□□□

2

(capacitance)

□

3

(tolerance)

□□□□

4

(rated voltage)

□

5

(Dc/Ac)

□□□□□□

6

(Size)

□

7

(lead forming)

□□

8

(lead pitch)

□□

9

(lead length)

6-1 tape:

Code	PEI	MEF	MEM	MPP	PEN	PPN	PPS	MEC	MET
Tape	PEI	MEF	MEM	MPP	PEN	PPN	PPS	MEC	MET

6-2 Capacitance:

Code	101	102	103	104	105	106
Capacitance	0.0001uF	0.001uF	0.01uF	0.1uF	1uF	10uF

6-3 Tolerance:

Code	F	G	H	I	J	K	M
Tolerance	±1%	±2%	±2.5%	±3%	±5%	±10%	±20%

文件名称

MPP Approval Sheet-QP
(MPP-TYPE Metallized Polypropylene
Film Interference Suppression Capacitor)

文件编号

QP-AP-28

页码





07/02

6-4 Rated Voltage: Showing the real working voltage indicated. For example: 0630 -> 630V, 1000 -> 1KV。

6-5 D→DC; A→AC

6-6 Size:090805→(W)9*(H)8*(T)5

6-7 Lead forming:

Code	B	K	R	U	W	T	S
Lead Forming						TAPING	Customer Special Require

6-8 Lead Pitch: Showing the capacitor lead pitch, For example:

Code	08	10	15	20	28
Pitch(mm)	7.5mm	10mm	15mm	20mm	27.5mm

6-9 Lead length: Showing the capacitor lead Length, For example:

Code	04	08	10	13	23	30	40
Length(mm)	4mm	8mm	10mm	13mm	23mm	30mm	40mm

7. Specifications (JIS 5115、IEC384-16)

No	Test items	Performance	Test Method
7-1	Withstand voltage (Between Terminals)	Shall be no abnormality	150% Of Rated Voltage, 60sec.
	Between terminal and Enclosure	Shall be no abnormality	UR×200%+1000VDC, 60sec.
7-2	Insulation resistance (Between Terminals)	$C_R \leq 0.33\mu F$ IR ≥ 9,000MΩ $C_R > 0.33\mu F$ IR ≥ 3,000 (MΩ . uF)	Measured at 100±15VDC, For 60sec / 25℃



文件名称

MPP Approval Sheet-QP
(MPP-TYPE Metallized Polypropylene
Film Interference Suppression Capacitor)

文件编号

QP-AP-28

页码

07/03

No	Test items	Performance	Test Method
7-3	Capacitance	Within the tolerance specified	1KHz, 1Vrms Max. at 25°C
7-4	Dissipation Factor	0.001 (0.1%) Max.	1KHz, 1Vrms Max. at 25°C
7-5	Tense Strength of Terminal	No wire breakage and No Damage of Capacitor	1. Load Force : 1.0 Kg 2. Holding Time : 10 ± 1sec
7-6	Bending Strength of Terminal	No wire breakage and No Damage of Capacitor	1. Load Force : 0.5 Kg 2. Bending Time : 4 x 90 ° in 5sec
7-7	Vibration	(1) Appearance : No Visible Damage (2) Contact : Normal	a. Frequency change : 1min. per cycle 10~55~10Hz b. Vibration distance : 1.5mm c. course: X、 Y、 Z (axis) d. Time : 2h / axis (6h in total)
7-8	Solder-ability	75% Of The Surface Tinning	a. Solder temperature: 270±5°C b. Solder time: 3±0.5sec
7-9	Heat Shock test	(1) Appearance : No Visible Damage (2) Withstand Voltage : Normal (3) Capacitance Change : ≤ ±3% of The Initial Value	The terminal of capacitor shall be immersed in the melting solder. a. Solder temperature: 270±5°C b. Solder time: 3±0.5sec c. Test Voltage: 150% of The Rate Voltage For 1min.



文件名称

MPP Approval Sheet-QP
(MPP-TYPE Metallized Polypropylene Film
Interference Suppression Capacitor)

文件编号

QP-AP-28

页码

07/04

No	Test items	Performance	Test Method
7-10	Cold Resistance	(1) Appearance : No Visible Damage (2) Capacitance Change : $\leq 0 \sim -10\%$ of The Initial Value	a. Test Temperature: -40°C b. Test Times: 2Hrs
7-11	Dry Heat Resistance	(1) Appearance : No Visible Damage (2) Withstand Voltage : Normal (3) Capacitance Change : $\leq +5 \sim -2\%$ Of The Initial Value (4) Insulation Resistance: $C_R \leq 0.33\mu\text{F}$ IR $\geq 2,700\text{M}\Omega$ $C_R > 0.33\mu\text{F}$ IR $\geq 900\text{M}\Omega$	a. TEST TEMPERATURE: $105^{\circ}\text{C} \pm 2^{\circ}\text{C}$ b. Test Times: 2Hrs
7-12	Humidity Resistance	(1) Appearance : No Visible Damage (2) Withstand Voltage : Normal (3) Capacitance Change : $\leq \pm 10\%$ of The Initial Value (4) Insulation Resistance: $C_R \leq 0.33\mu\text{F}$ IR $\geq 2,700\text{M}\Omega$ $C_R > 0.33\mu\text{F}$ IR $\geq 900\text{M}\Omega$ (5) DF ($\tan \delta$) ≤ 0.001	a. TEST TEMPERATURE: $-40^{\circ}\text{C} \pm 2^{\circ}\text{C}$ b. RELATIVE HUMIDITY: $90 \sim 95\%$ c. Test Times: $240 \pm 8\text{HRS}$ d. TEST VOLTAGE: 130% of The Rated Voltage for 1 min.
7-13	Heat Resistance (Charge & Discharge)	(1) Appearance : No Visible Damage (2) DF ($\tan \delta$) ≤ 0.001 (3) Capacitance Change : $\pm 10\%$ of The Initial Value (4) Insulation Resistance: Over $3000\text{M}\Omega$	a. Test Voltage : Rated Voltage Charge for 2 sec. Discharge for 2 sec. Repeated For $100,000 \pm 1000$ cycles b. Test Temperature: $105^{\circ}\text{C} \pm 2^{\circ}\text{C}$
7-14	Heat Resistance (Continuous)	(1) Appearance : No Visible Damage (2) DF ($\tan \delta$) ≤ 0.001 (3) Capacitance Change : $\pm 7\%$ of The Initial Value (4) Insulation Resistance: Over $3000\text{M}\Omega$	a. Test Voltage : 125% of The Rated Voltage b. Test Temperature: $105^{\circ}\text{C} \pm 2^{\circ}\text{C}$ c. Test Times: $500 \pm 24\text{Hrs}$

8.Dimensions:

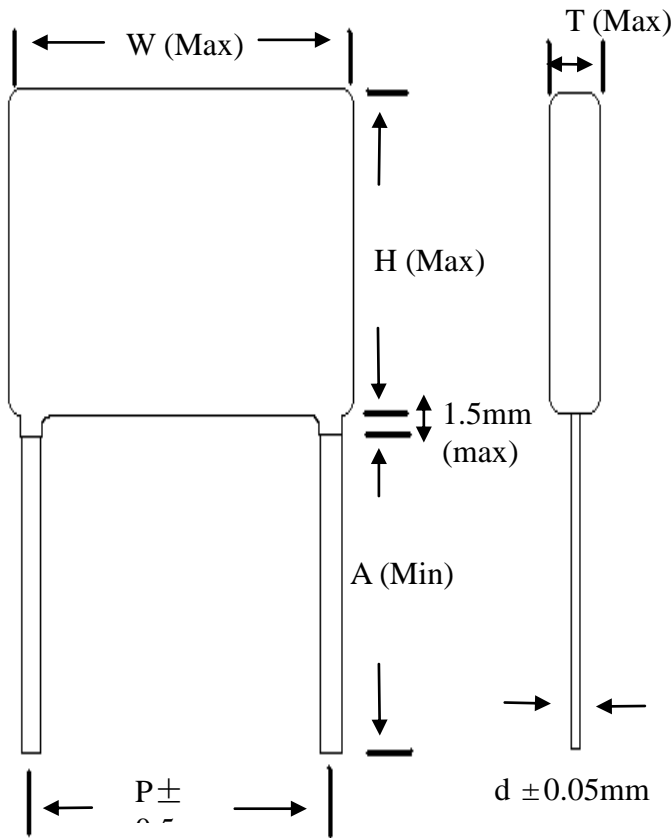

9.Specification size reference:

标称容量单位: nF 尺寸单位: mm

容量代码	标称容量	250VDC				400VDC				630VDC				1000VDC			
		宽(W)	高(H)	厚(T)	线径	宽(W)	高(H)	厚(T)	线径	宽(W)	高(H)	厚(T)	线径	宽(W)	高(H)	厚(T)	线径
103	10	10	9	4	0.6	10	9	4	0.6	10	9	4	0.6				
103	10	13	11	5	0.6	13	11	5	0.6	13	11	5	0.6	13	11	5	0.6
123	12	10	9	4	0.6	10	9	4	0.6	10	9	4	0.6				
153	15					10	9	4	0.6	10	9	4	0.6				
183	18					13	12	6	0.6	10	9	4	0.6				
223	22					10	9	4	0.6	10	9	4	0.6	13	12	6	0.6
273	27					13	12	6	0.6	10	9	4	0.6				
332	3.3									10	9	4	0.6				
333	33									10	9	4	0.6				
393	39					13	12	6	0.6								
473	47					10	9	4	0.6	13	12	6	0.6				
563	56					13	12	6	0.6								
682	6.8									10	9	4	0.6				
683	68					10	12	6						13	12	6	0.6
823	82					13	12	6	0.6					10	12	6	0.6
104	100					13	12	6	0.6	13	12	6	0.6	13	12	6	0.6
104	100					18	12	6	0.8	18	12	6	0.8	18	12	6	0.8
124	120					13	12	6	0.6	13	12	6	0.6	13	12	6	0.6
124	120					18	12	6	0.8	18	12	6	0.8	18	12	6	0.8



东莞市全鹏电子科技有限公司

制作日期

2018-08-24

版本

01

文件名称

MPP Approval Sheet-QP
(MPP-TYPE Metallized Polypropylene Film
Interference Suppression Capacitor)

文件编号

QP-AP-28

页码

07/06

154	150					13	12	6	0.6	13	12	6	0.6	13	12	6	0.6
184	150					10	12	6	0.6	18	12	6	0.8				
224	220					13	12	6	0.6	13	12	6	0.6	13	12	6	0.6
224	220					18	12	6	0.8	18	12	6	0.8				
224	220					26.5	16.5	7	0.8	26.5	16.5	7	0.8	26.5	16.5	7	0.8
274	270					18	12	6	0.8	18	13.5	7.5	0.8				
334	330									18	13.5	7.5	0.8	18	14.5	8.4	0.8
394	390					18	14.5	8.4	0.8								
474	470					18	13.5	7.5	0.8					18	15.5	9.5	0.8
564	560					18	14.5	8.4	0.8	26.5	17	8.5	0.8				
684	680					18	14.5	8.4	0.8					18	15.5	9.5	0.8
824	820	18	14.5	8.4	0.8									26.5	19	10	0.8
105	1000									26.5	19	10	0.8	26	21.5	12	0.8
125	1200					26.5	19	10	0.8	31.4	19.5	10.8	0.8				
155	1500					26.5	19.5	10	0.8	31.4	19.5	10.8	0.8				
185	1800					26.5	19.5	10	0.8	31.4	19.5	10.8	0.8				
225	2200					26	21.5	12	0.8	31.5	21.6	13	0.8				
275	2700	26	21.5	12	0.8					31.5	19.5	10.8	0.8				
335	3300					31.5	19.5	10.8	0.8	31	25	14	0.8				
395	3900					31.5	19.5	10.8	0.8								
475	4700					32	28	18	0.8								
565	5600					32	28	18	0.8								
685	6800	32	28	18	0.8												
825	8200	32	28	18	0.8												
106	10000	32	28	18	0.8												
156	15000	32	28	18	0.8												

10. Convention Marking:

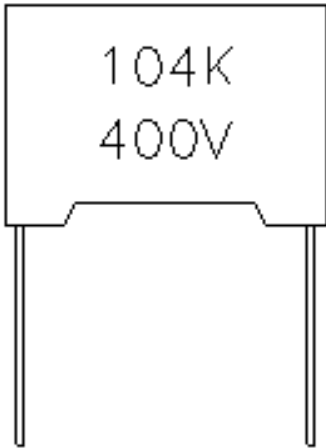

104	CAPACITANCE CODE
K	CAPACITANCE TOLERANCE
275V	DC rated voltage

X-ON Electronics

Largest Supplier of Electrical and Electronic Components

Click to view similar products for [Film Capacitors](#) category:

Click to view products by [CHAMPION](#) manufacturer:

Other Similar products are found below :

[M83421/01-3089R](#) [703-6G](#) [F450KG153J250ALH0J](#) [750-1018](#) [FKP1-1000160010P15](#) [FKP1-1500160010P15](#) [82EC1100DQ50K](#)
[MMWAF150KME](#) [PCY2130F30153](#) [PME261JB5220KR19T0](#) [A521HH333M035C](#) [QXJ2E474KTPT](#) [QXL2B333KTPT](#) [QXM2G104K](#)
[B32234-.033@250V-K](#) [B32520C6332K000](#) [B32522C6104K000](#) [B32523Q3155J](#) [B32676E6755K](#) [B81133-C1104-M3](#) [MTC355L1](#) [217-0716-](#)
[001](#) [PA225L30](#) [221A10-120](#) [CB182K0184J--](#) [KP1830-247/061-G](#) [SCD105K122A3-22](#) [SCD205K122A3-24](#) [F601BL225K063CL60A](#)
[PCX2339F65224](#) [PCX2339F65334](#) [2222 368 55105](#) [2222 370 21683](#) [QXL2E473KTPT](#) [445450-1](#) [B32524Q6155J](#) [46KI3100JBM1K](#)
[MKP383510063JKP2T0](#) [MKT182022263473](#) [WMC08P22](#) [WMF4S68](#) [YE333](#) [ECQ-W4223KZ](#) [EEC2G805HQA415](#) [PA103L30](#)
[82DC3100DQ50J](#) [82EC2150DQ50K](#) [WMF1D68](#) [PHE841ED6150MR17T0](#) [F850AG102M300C](#)