



SOT-89-3L Plastic-Encapsulate Transistors

2SA1797 TRANSISTOR (PNP)

FEATURES

- Low saturation voltage
- Excellent DC current gain characteristics
- Complements to 2SC4672

MAXIMUM RATINGS (T_a=25°C unless otherwise noted)

Symbol	Parameter	Value	Unit
V _{CB0}	Collector-Base Voltage	-50	V
V _{CE0}	Collector-Emitter Voltage	-50	V
V _{EBO}	Emitter-Base Voltage	-6	V
I _c	Continuous Collector Current	-2	A
I _{CM}	Peak Pluse Current	-3	A
P _c	Collector Power dissipation	500	mW
T _J	Junction Temperature	150	°C
T _{stg}	Storage Temperature	-55~150	°C

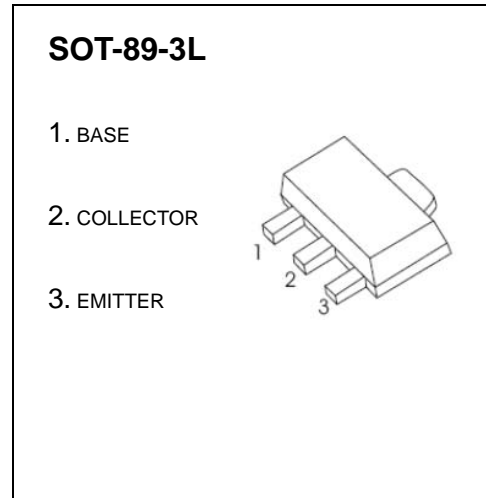

ELECTRICAL CHARACTERISTICS (T_a=25°C unless otherwise specified)

Parameter	Symbol	Test conditions	Min	Typ	Max	Unit
Collector-base breakdown voltage	V _{(BR)CBO}	I _C =-50μA, I _E =0	-50			V
Collector-emitter breakdown voltage	V _{(BR)CEO}	I _C =-1mA, I _B =0	-50			V
Emitter-base breakdown voltage	V _{(BR)EBO}	I _E =-50μA, I _C =0	-6			V
Collector cut-off current	I _{CBO}	V _{CB} =-50V, I _E =0			-0.1	μA
Emitter cut-off current	I _{EBO}	V _{EB} =-5V, I _C =0			-0.1	μA
DC current gain	h _{FE}	V _{CE} =-2V, I _C =-500mA	82		270	
Collector-emitter saturation voltage	V _{CE(sat)}	I _C =-1A, I _B =-50mA			-0.35	V
Transition frequency	f _T	V _{CE} =-2V, I _C =-0.5A, f=100MHz		200		MHz
Collector output capacitance	C _{ob}	V _{CB} =-10V, I _E =0, f=1MHz		36		pF

CLASSIFICATION OF h_{FE}

Rank	P	Q
Range	82-180	120-270
Marking	AGP	AGQ

Typical Characteristics

2SA1797

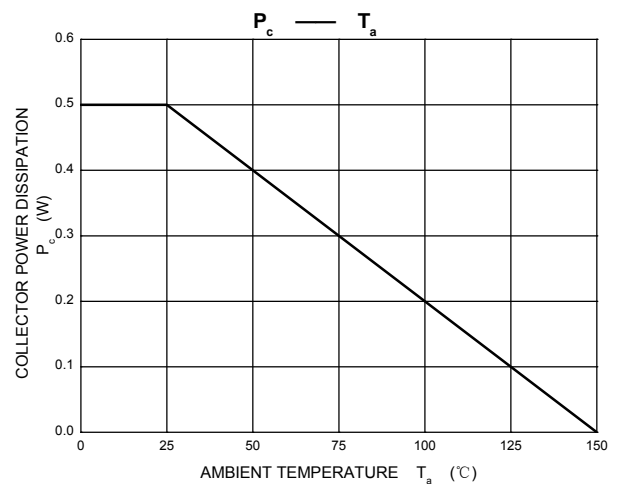
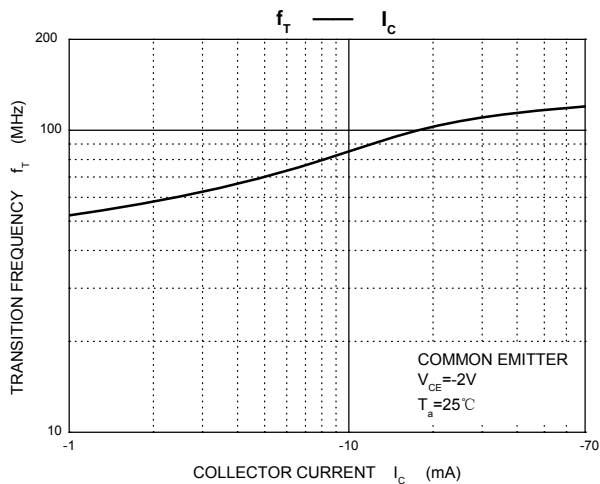
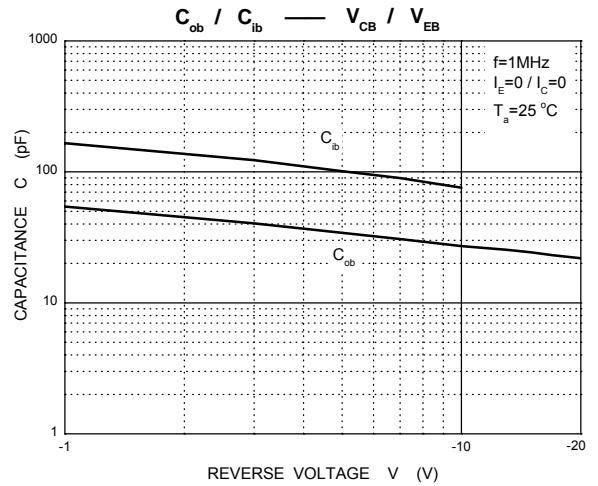
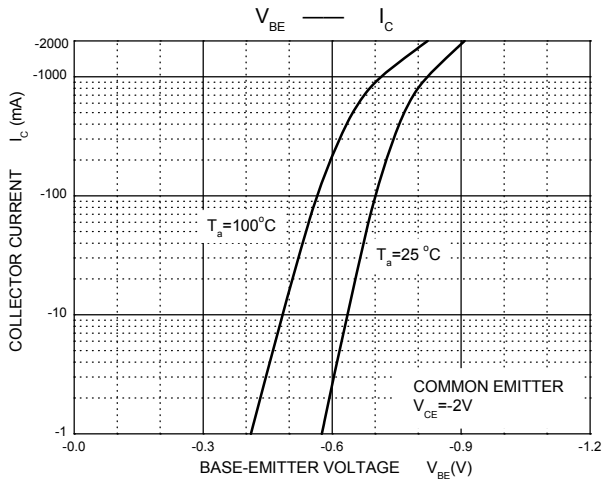
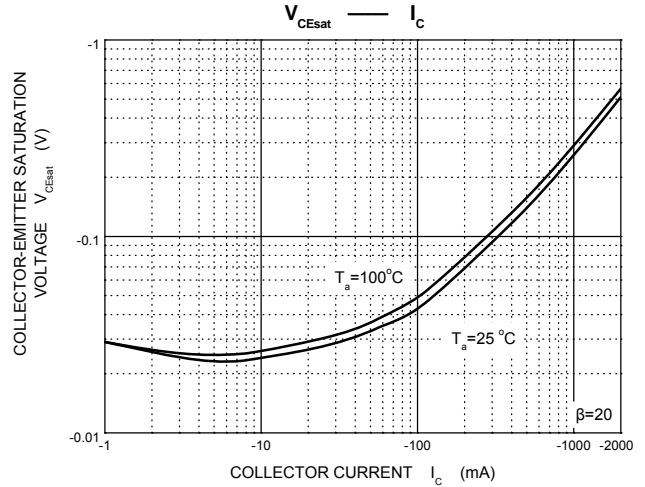
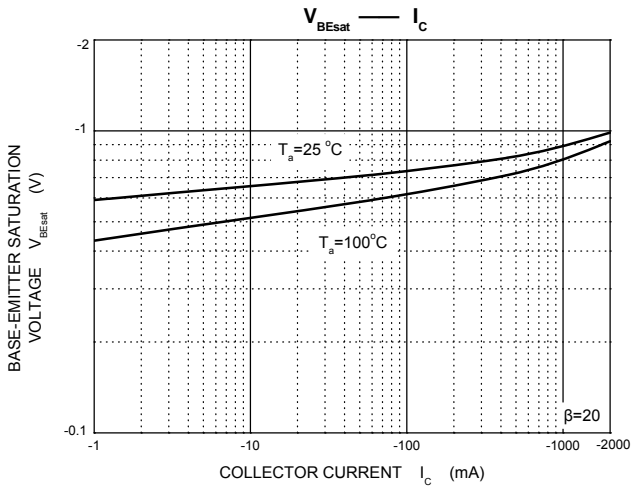
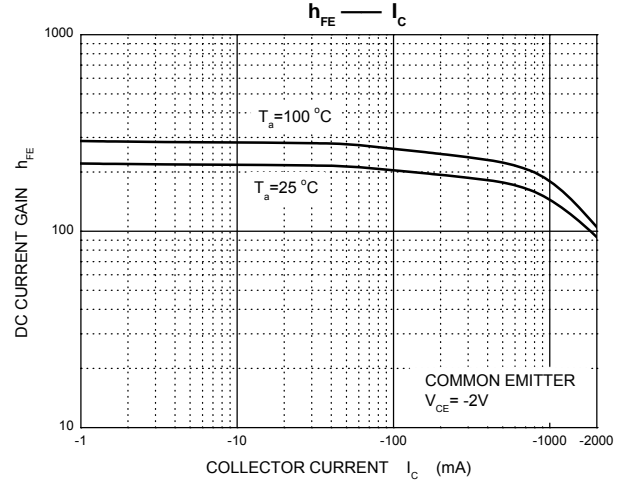
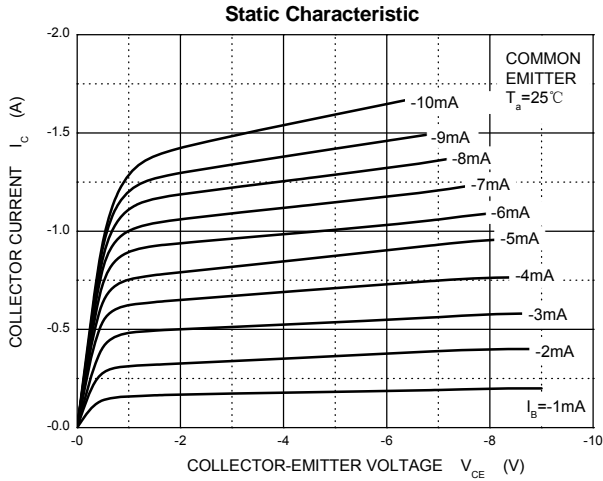

X-ON Electronics

Largest Supplier of Electrical and Electronic Components

Click to view similar products for [Bipolar Transistors - BJT category](#):

Click to view products by [Changjiang manufacturer](#):

Other Similar products are found below :

[619691C](#) [MCH4017-TL-H](#) [MMBT-2369-TR](#) [BC546/116](#) [BC557/116](#) [BSW67A](#) [NJVMJD148T4G](#) [NTE123AP-10](#) [NTE153MCP](#) [NTE16](#)
[NTE195A](#) [NTE92](#) [C4460](#) [2N4401-A](#) [2N6728](#) [2SA1419T-TD-H](#) [2SA2126-E](#) [2SB1204S-TL-E](#) [2SC2712S-GR,LF](#) [2SC5488A-TL-H](#)
[2SD2150T100R](#) [SP000011176](#) [2N2907A](#) [2N3904-NS](#) [2N5769](#) [2SC2412KT146S](#) [2SD1816S-TL-E](#) [CPH6501-TL-E](#) [MCH4021-TL-E](#)
[MJE340](#) [US6T6TR](#) [NJL0281DG](#) [732314D](#) [CPH3121-TL-E](#) [CPH6021-TL-H](#) [873787E](#) [IMZ2AT108](#) [UMX21NTR](#) [MCH6102-TL-E](#)
[NJL0302DG](#) [2N3583](#) [30A02MH-TL-E](#) [NSV40301MZ4T1G](#) [NTE13](#) [NTE26](#) [NTE282](#) [NTE323](#) [NTE350](#) [NTE81](#) [STX83003-AP](#)