

Specifications

- Current rating:1A AC,DC
- Voltage rating:50V AC,DC
- Temperature range:-40°C~+105°C
- Contact resistance:20mΩMax.
- Insulation resistance:100MΩMin.
- Withstanding voltage:500V AC/minute
- *Compliant with RoHS and REACH*
- *Meet the HF/Halogen Free,need to customize*
- *Contact CJT for details*

Standards

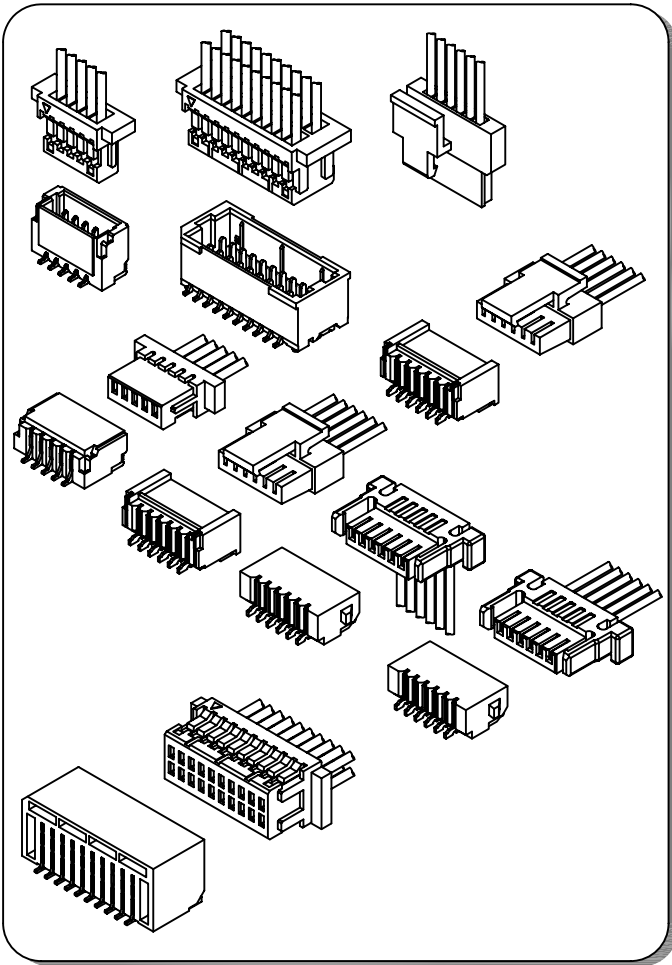

Assembly layout

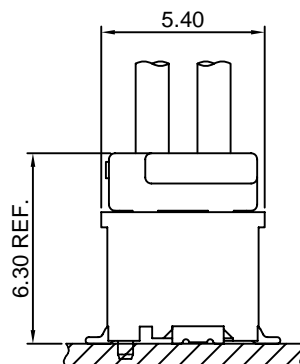
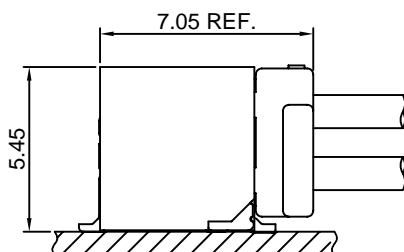
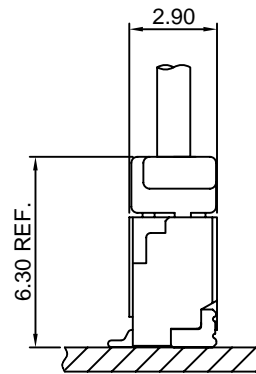
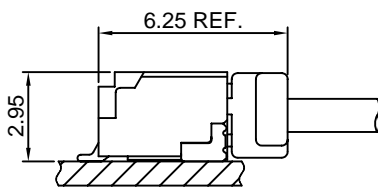

A1002-T

1.00mm pitch Crimp Terminal

Reference Informations:

*Used in CJT A1002H-XP(-2),A1002H-2xXP series Housing

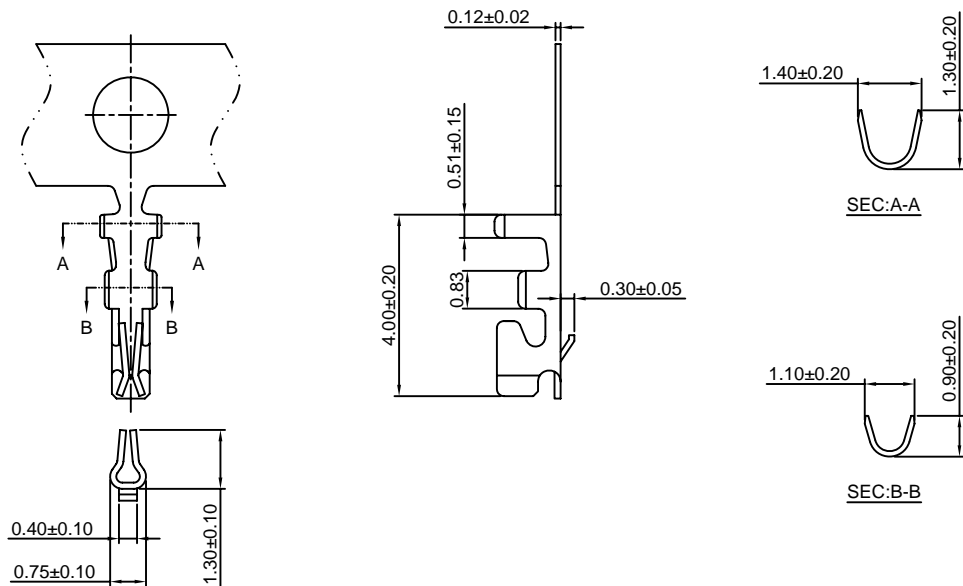

Ordering information & Specifications:

Unit:mm

Part NO.	Wire Range	Insulation O.D.	Material	Finish	Qty/reel
A1002-TP	AWG#28-#32	0.80mm(max)	Phosphor Bronze	Tin over Nickel	20,000 PCS
A1002-GP	AWG#28-#32	0.80mm(max)	Phosphor Bronze	Gold over flash	20,000 PCS

Optional Gold plating available but MOQ requested

A1002A-T

1.00mm pitch Crimp Terminal

Reference Informations:

*Used in CJT A1002HA,HB,HE-XP series Housing

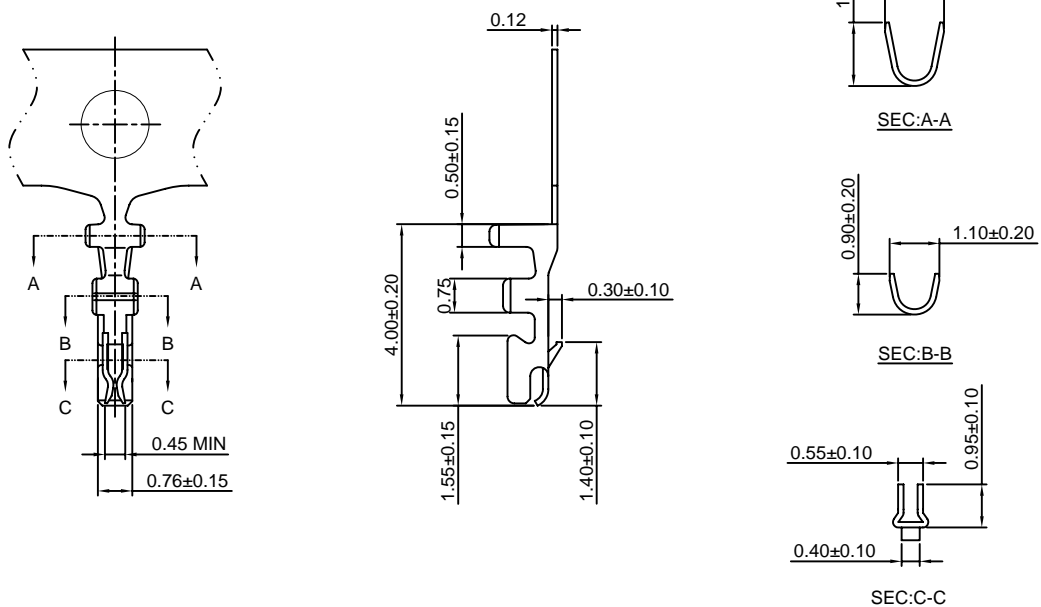

Ordering information & Specifications:

Unit:mm

Part NO.	Wire Range	Insulation O.D.	Material	Finish	Qty/reel
A1002A-TP	AWG#28-#32	0.80mm(max)	Phosphor Bronze	Tin over Nickel	20,000 PCS
A1002A-GP	AWG#28-#32	0.80mm(max)	Phosphor Bronze	Gold over flash	20,000 PCS

Optional Gold plating available but MOQ requested

A1002C-T

1.00mm pitch Crimp Terminal

Reference Informations:

*Used in CJT A1002HC,HD-XP series Housing

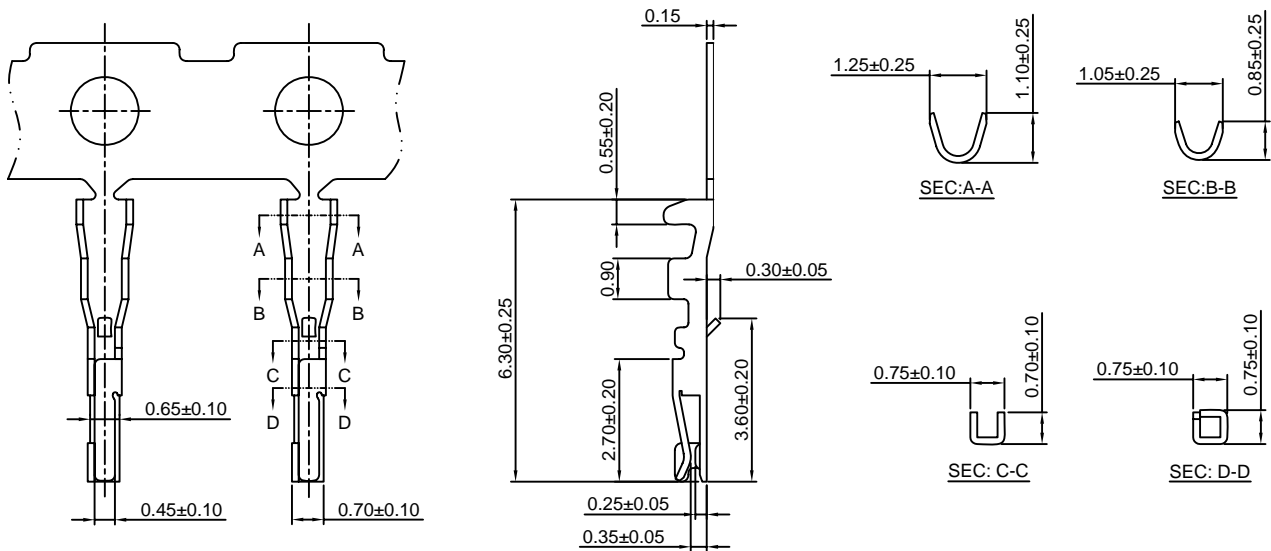

Ordering information & Specifications:

Unit:mm

Part NO.	Wire Range	Insulation O.D.	Material	Finish	Qty/reel
A1002C-TP	AWG#28-#32	0.80mm(max)	Phosphor Bronze	Tin over Nickel	20,000 PCS
A1002C-GP	AWG#28-#32	0.80mm(max)	Phosphor Bronze	Gold over flash	20,000 PCS

Optional Gold plating available but MOQ requested

A1002D-T

1.00mm pitch Crimp Terminal

Reference Informations:

*Used in CJT A1002HG,HI-XP series Housing

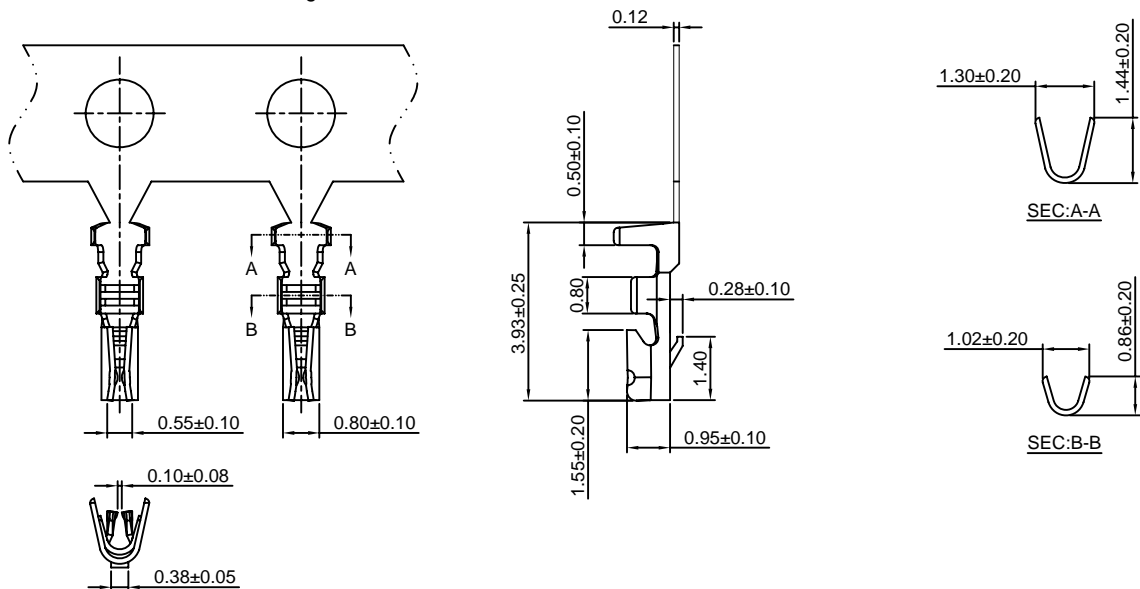

Ordering information & Specifications:

Unit:mm

Part NO.	Wire Range	Insulation O.D.	Material	Finish	Qty/reel
A1002D-TP	AWG#28-#32	0.80mm(max)	Phosphor Bronze	Tin over Nickel	20,000 PCS
A1002D-GP	AWG#28-#32	0.80mm(max)	Phosphor Bronze	Gold over flash	20,000 PCS

Optional Gold plating available but MOQ requested

A1002H-XP

1.00mm pitch Single Row Housing

Reference Informations:

- *Material:PBT,UL94V-0
- *Suitable CJT A1002-T series Terminal
- *Mates with CJT A1002WV-S,WR-S-XP series Single Row Wafer
- *Color:White

Ordering Information:

A1002H-XP - ***
1 2

1.Part No.

2.Material:

(Blank):PBT,UL94V-0

GWT:PBT,UL94V-0,GWT 750°C

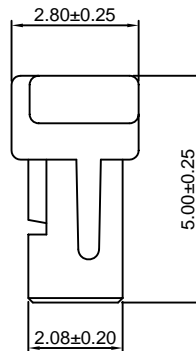
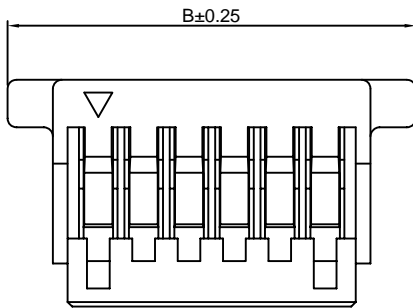
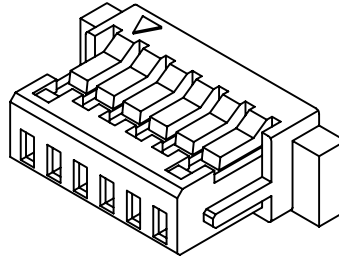
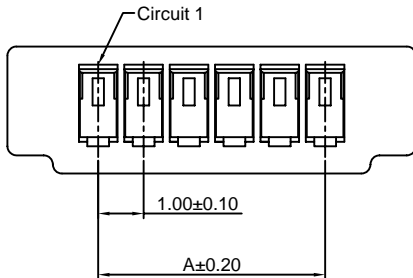

Ordering Information & Dimensions:

PART NO.	Dimensions	
	A	B
2P	1.00	5.00
3P	2.00	6.00
4P	3.00	7.00
5P	4.00	8.00
6P	5.00	9.00
7P	6.00	10.00
8P	7.00	11.00
9P	8.00	12.00
10P	9.00	13.00
11P	10.00	14.00
12P	11.00	15.00
13P	12.00	16.00
14P	13.00	17.00
15P	14.00	18.00
16P	15.00	19.00
17P	16.00	20.00
18P	17.00	21.00
19P	18.00	22.00
20P	19.00	23.00

Unit: mm

A1002H-XP-2

1.00mm pitch Single Row Housing

Reference Informations:

- *Material:PBT,UL94V-0
- *Suitable CJT A1002-T series Terminal
- *Mates with CJT A1002WV-S,WR-S-XP series Single Row Wafer
- *Color:White

Ordering Information:

A1002H-XP-2 - ***
1 2

1.Part No.

2.Material:

(Blank):PBT,UL94V-0

GWT:PBT,UL94V-0,GWT 750°C

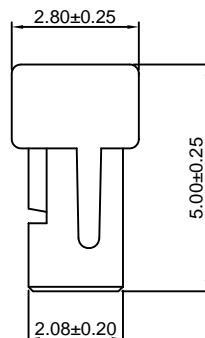
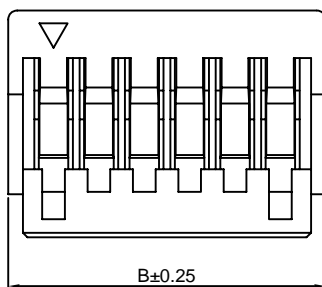
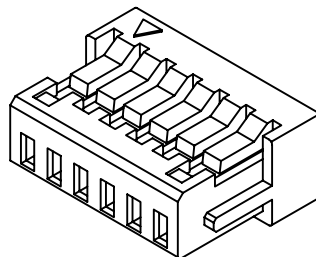
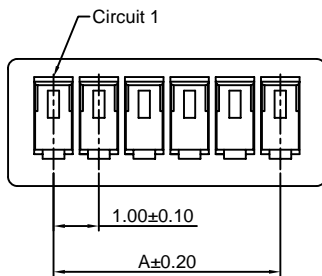

Ordering Information & Dimensions:

PART NO.	Dimensions	
	A	B
2P	1.00	3.00
3P	2.00	4.00
4P	3.00	5.00
5P	4.00	6.00
6P	5.00	7.00
7P	6.00	8.00
8P	7.00	9.00
9P	8.00	10.00
10P	9.00	11.00
11P	10.00	12.00
12P	11.00	13.00
13P	12.00	14.00
14P	13.00	15.00
15P	14.00	16.00
16P	15.00	17.00
17P	16.00	18.00
18P	17.00	19.00
19P	18.00	20.00
20P	19.00	21.00

Unit: mm

A1002HA-XP

1.00mm pitch Single Row Housing

Reference Informations:

- *Material:PBT,UL94V-0
- *Suitable CJT A1002A-T series Terminal
- *Mates with CJT A1002WRA-S,WRE-S-XP series Single Row Wafer
- *Color:White

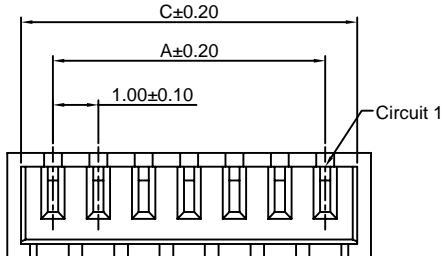
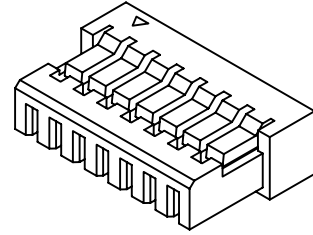

Ordering Information:

A1002HA-XP - ***
1 2

- 1.Part No.
- 2.Material:
(Blank):PBT,UL94V-0
GWT :PBT,UL94V-0,GWT 750 °C

Ordering Information & Dimensions:

PART NO.	Dimensions		
	A	B	C
2P	1.00	3.00	2.40
3P	2.00	4.00	3.40
4P	3.00	5.00	4.40
5P	4.00	6.00	5.40
6P	5.00	7.00	6.40
7P	6.00	8.00	7.40
8P	7.00	9.00	8.40
9P	8.00	10.00	9.40
10P	9.00	11.00	10.40
11P	10.00	12.00	11.40
12P	11.00	13.00	12.40
13P	12.00	14.00	13.40
14P	13.00	15.00	14.40
15P	14.00	16.00	15.40
16P	15.00	17.00	16.40
17P	16.00	18.00	17.40
18P	17.00	19.00	18.40
19P	18.00	20.00	19.40
20P	19.00	21.00	20.40

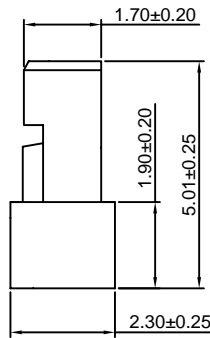
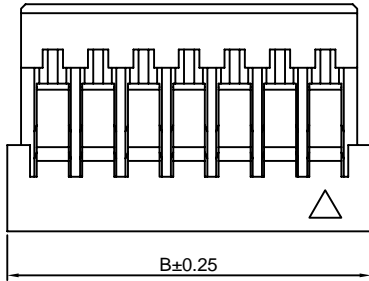

Unit:mm

A1002HB-XP

1.00mm pitch Single Row Housing

Reference Informations:

- *Material:Nylon 66,UL94V-0
- *Suitable CJT A1002A-T series Terminal
- *Mates with CJT A1002WVB-S,WRB-S-XP series Wafer
- *Color:White

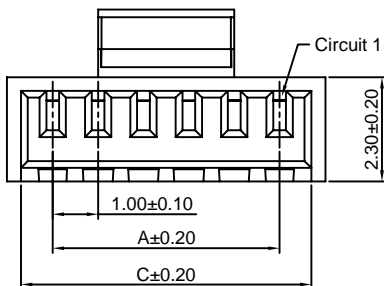
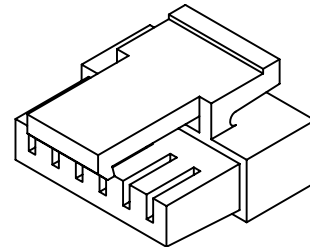

Ordering Information:

A1002HB-XP - ***
1 2

- 1.Part No.
- 2.Material:
(Blank):Nylon 66,UL94V-0
GWT :Nylon 66,UL94V-0,GWT 750 °C

Ordering Information & Dimensions:

PART NO.	Dimensions		
	A	B	C
2P	1.00	3.00	2.40
3P	2.00	4.00	3.40
4P	3.00	5.00	4.40
5P	4.00	6.00	5.40
6P	5.00	7.00	6.40
7P	6.00	8.00	7.40
8P	7.00	9.00	8.40
9P	8.00	10.00	9.40
10P	9.00	11.00	10.40
11P	10.00	12.00	11.40
12P	11.00	13.00	12.40
13P	12.00	14.00	13.40
14P	13.00	15.00	14.40
15P	14.00	16.00	15.40
16P	15.00	17.00	16.40
17P	16.00	18.00	17.40
18P	17.00	19.00	18.40
19P	18.00	20.00	19.40
20P	19.00	21.00	20.40

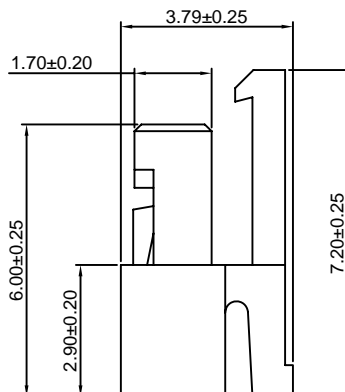
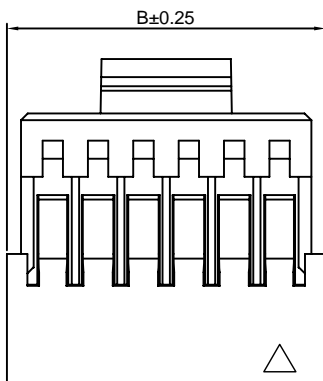

Unit:mm

A1002HC-XP

1.00mm pitch Single Row Housing

Reference Informations:

- *Material:Nylon 46,UL94V-0
- *Suitable CJT A1002C-T series Terminal
- *Color:Ivory

Ordering Information:

- A1002HC-XP - ***
 $\frac{1}{2}$
- 1.Part No.
 - 2.Material:
 (Blank):Nylon 46,UL94V-0
 GWT:Nylon 46,UL94V-0,GWT 750 °C

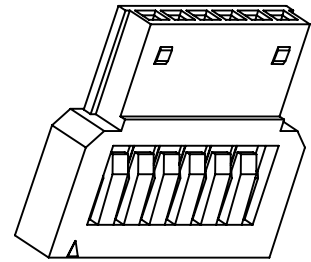
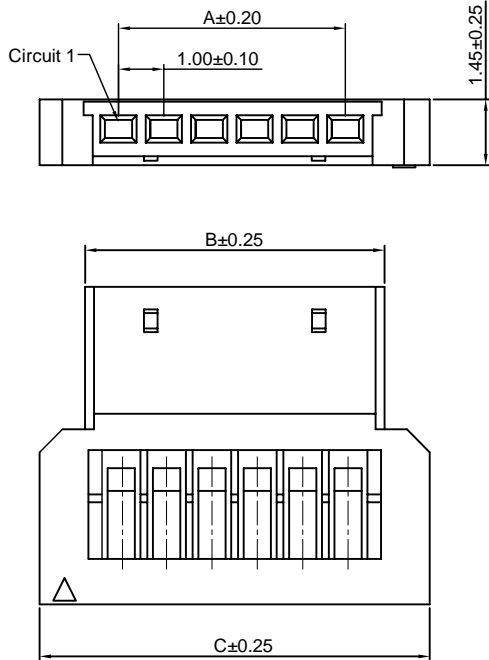

Ordering Information & Dimensions:

PART NO.	Dimensions		
	A	B	C
4P	3.00	4.60	6.60
6P	5.00	6.60	8.60

Unit:mm

A1002HD-XP

1.00mm pitch Single Row Housing

Reference Informations:

- *Material:Nylon 46,UL94V-0
- *Suitable CJT A1002C-T series Terminal
- *Color:Ivory

Ordering Information:

- A1002HD-XP - ***
 $\frac{1}{2}$
- 1.Part No.
 - 2.Material:
 (Blank):Nylon 46,UL94V-0
 GWT :Nylon 46,UL94V-0 GWT 750 °C

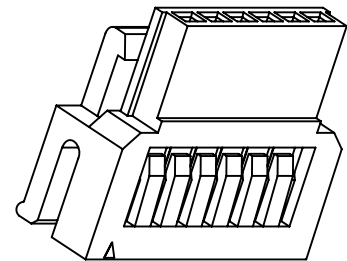
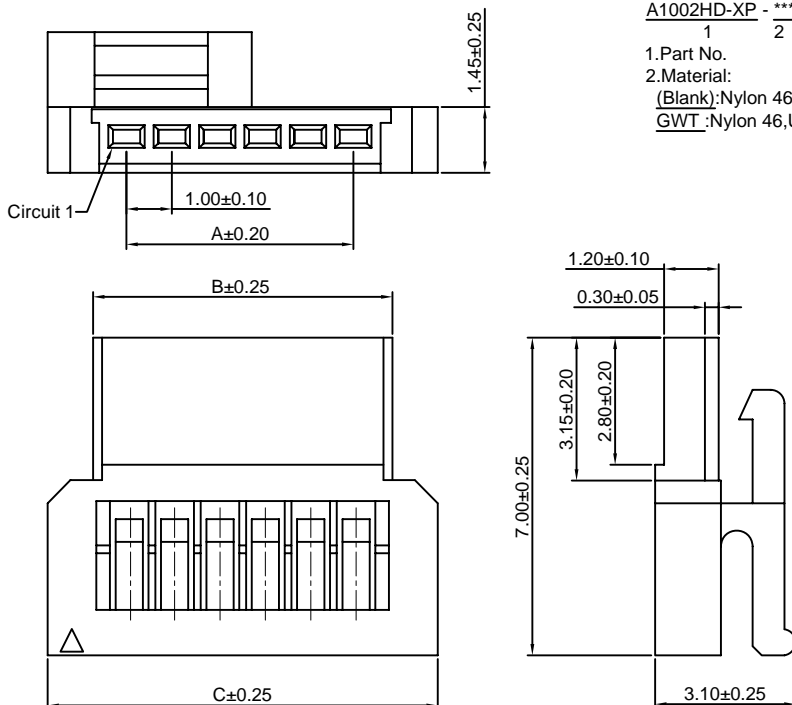

Ordering Information & Dimensions:

PART NO.	Dimensions		
	A	B	C
4P	3.00	4.60	6.60
6P	5.00	6.60	8.60

Unit:mm

A1002HE-XP

1.00mm pitch Single Row Housing

Reference Informations:

- *Material:Nylon 66,UL94V-0
- *Suitable CJT A1002A-T series Terminal
- *Mates with CJT A1002WRC-S-XP series Wafer
- *Color:White

Ordering Information:

- A1002HE-XP - ***
 $\frac{1}{2}$
- Part No.
 - Material:
 (Blank):Nylon 66,UL94V-0
 GWT:Nylon 66,UL94V-0,GWT 750 °C

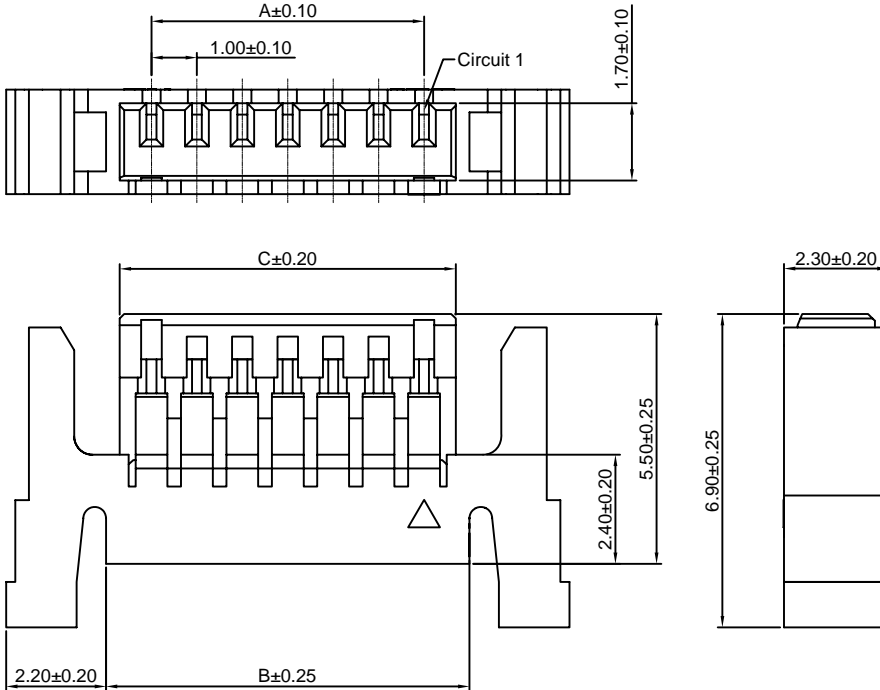

Ordering Information & Dimensions:

PART NO.	Dimensions		
	A	B	C
2P	1.00	3.00	2.40
3P	2.00	4.00	3.40
4P	3.00	5.00	4.40
5P	4.00	6.00	5.40
6P	5.00	7.00	6.40
7P	6.00	8.00	7.40
8P	7.00	9.00	8.40
9P	8.00	10.00	9.40
10P	9.00	11.00	10.40
11P	10.00	12.00	11.40
12P	11.00	13.00	12.40
13P	12.00	14.00	13.40
14P	13.00	15.00	14.40
15P	14.00	16.00	15.40
16P	15.00	17.00	16.40
17P	16.00	18.00	17.40
18P	17.00	19.00	18.40
19P	18.00	20.00	19.40
20P	19.00	21.00	20.40

Unit:mm

A1002HG-XP

1.00mm pitch 180° Single Row Housing

Reference Informations:

- *Material:Nylon 66,UL94V-0
- *Suitable CJT A1002D-T series Terminal
- *Mates with CJT A1002WRD-S-XP series Wafer
- *Color:White

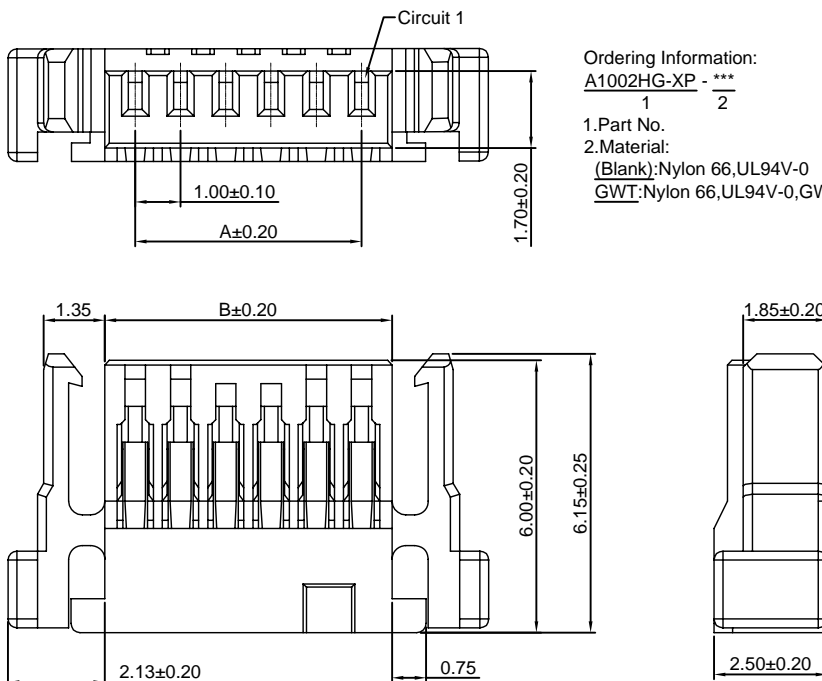
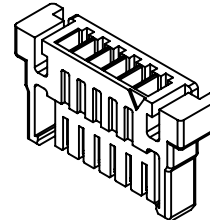

Ordering Information:

- A1002HG-XP - ***
 $\frac{1}{2}$
- Part No.
 - Material:
 (Blank):Nylon 66,UL94V-0
 GWT:Nylon 66,UL94V-0,GWT 750 °C

Ordering Information & Dimensions:

PART NO.	Dimensions	
	A	B
2P	1.00	2.30
3P	2.00	3.30
4P	3.00	4.30
5P	4.00	5.30
6P	5.00	6.30
7P	6.00	7.30
8P	7.00	8.30
9P	8.00	9.30
10P	9.00	10.30
11P	10.00	11.30
12P	11.00	12.30
13P	12.00	13.30
14P	13.00	14.30
15P	14.00	15.30
16P	15.00	16.30
17P	16.00	17.30
18P	17.00	18.30
19P	18.00	19.30
20P	19.00	20.30

Unit:mm

A1002HI-XP

1.00mm pitch 90° Single Row Housing

Reference Informations:

- *Material:Nylon 66,UL94V-0
- *Suitable CJT A1002D-T series Terminal
- *Mates with CJT A1002WRD-S-XP series Wafer
- *Color:White

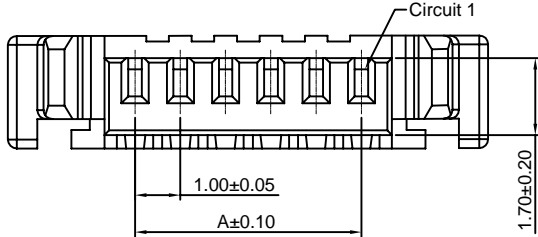
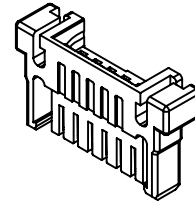

Ordering Information:

A1002HI-XP - ***
1 2

1.Part No.

2.Material:

(Blank):Nylon 66,UL94V-0

GWT :Nylon 66,UL94V-0 GWT 750 °C

Ordering Information & Dimensions:

PART NO.	Dimensions	
	A	B
2P	1.00	2.30
3P	2.00	3.30
4P	3.00	4.30
5P	4.00	5.30
6P	5.00	6.30
7P	6.00	7.30
8P	7.00	8.30
9P	8.00	9.30
10P	9.00	10.30
11P	10.00	11.30
12P	11.00	12.30
13P	12.00	13.30
14P	13.00	14.30
15P	14.00	15.30
16P	15.00	16.30
17P	16.00	17.30
18P	17.00	18.30
19P	18.00	19.30
20P	19.00	20.30

Unit:mm

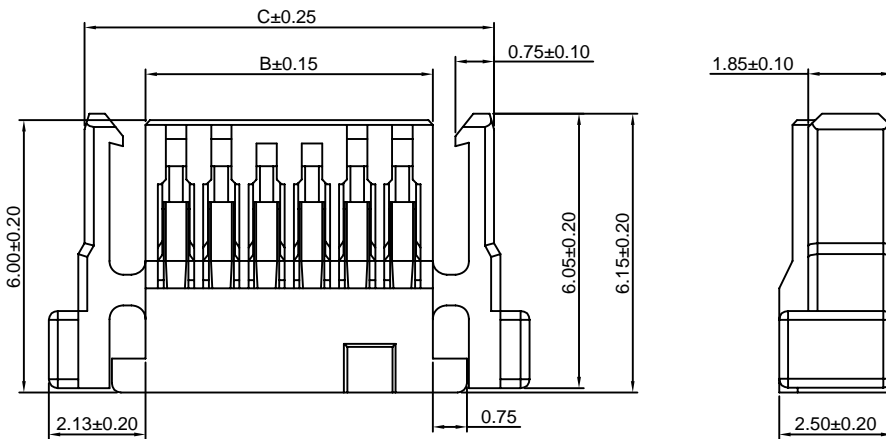

A1002HJ-XP

1.00mm pitch Single Row Housing

Reference Informations:

- *Material:Nylon 66,UL94V-0
- *Mates with CJT A1002WRJ-F-XP series Wafer
- *Color:Black

Ordering Information:

A1002HJ-XP - ***
1 2

1.Part No.

2.Material:

(Blank):Nylon 66,UL94V-0

GWT :Nylon 66,UL94V-0,GWT 750 °C

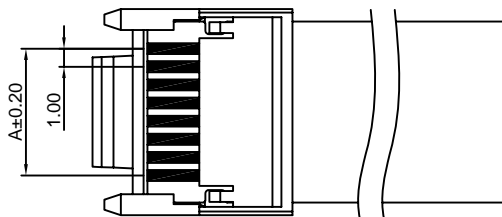
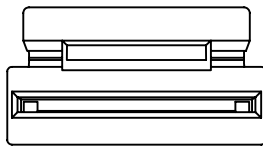
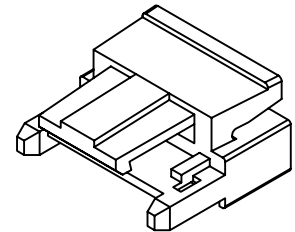

The FPC cable in the schematic diagram

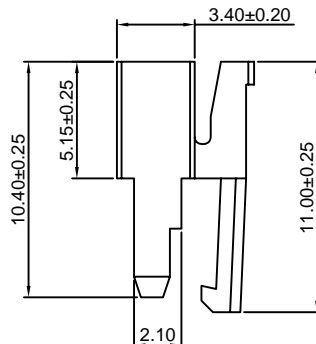
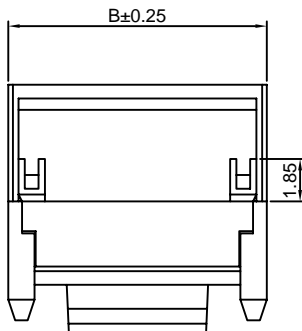

Ordering Information & Dimensions:

PART NO.	Dimensions	
	A	B
4P	3.00	7.35
5P	4.00	8.35
6P	5.00	9.35
7P	6.00	10.35
8P	7.00	11.35
9P	8.00	12.35
10P	9.00	13.35
11P	10.00	14.35
12P	11.00	15.35
13P	12.00	16.35
14P	13.00	17.35
15P	14.00	18.35
16P	15.00	19.35
17P	16.00	20.35
18P	17.00	21.35
19P	18.00	22.35
20P	19.00	23.35
30P	29.00	33.35

Unit:mm

A1002H-2xXP

1.00mm pitch Dual Row Housing

Reference Informations:

- *Material:PBT,UL94V-0
- *Suitable CJT A1002-T series Terminal
- *Mates with CJT A1002WV-S,WR-S-2xXP, A1002WV-S-F-2xXP series Dual Row Wafer
- *Color:White

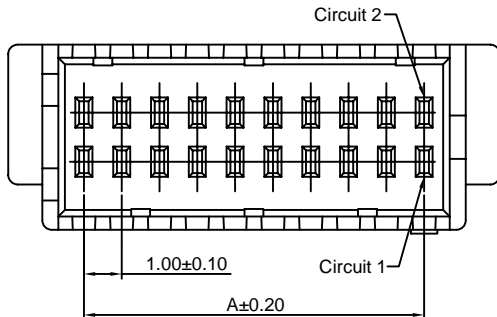

Ordering Information:
A1002HI-2xXP - ***
1 2

- 1.Part No.
- 2.Material:
(Blank):PBT,UL94V-0
GWT:PBT,UL94V-0,GWT 750 °C

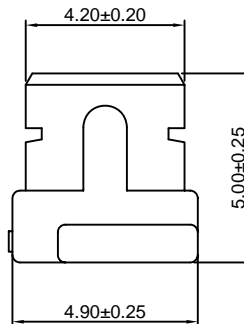
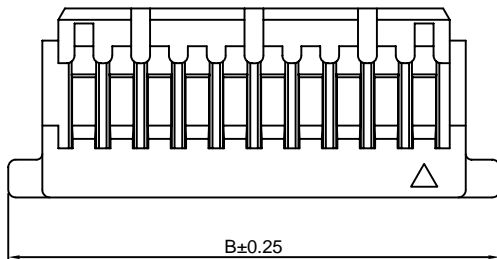
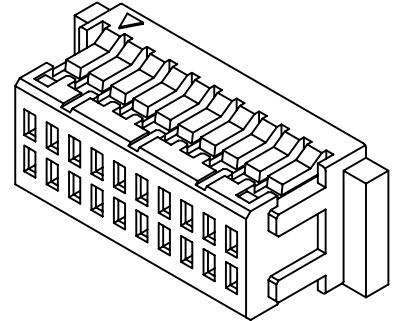

Ordering Information & Dimensions:

PART NO.	Dimensions	
	A	B
2x6P	5.00	9.00
2x8P	7.00	11.00
2x10P	9.00	13.00
2x15P	14.00	18.00
2x20P	19.00	23.00
2x25P	24.00	28.00

Unit: mm

A1002WV-S-XP

1.00mm pitch 180° Single Row Wafer - SMT TYPE

Reference Informations:

- *Material:Pin:Phosphor Bronze/Tin over Nickel
Solder Tabs: Phosphor Bronze/Tin over Nickel
Insulator:Nylon 6T,UL94V-0
- *Mates with CJT A1002H-XP(-2) series Single Row Housing
- *Color:Ivory

Ordering Information:
A1002WV-S-XP - *** - **
1 2 3

- 1.Part No.
- 2.Material:
(Blank):Nylon 6T,UL94V-0
GWT:Nylon 6T,UL94V-0,GWT 750 °C
- 3.Finish:
(Blank):Tin over Nickel
G:Gold over Nickel

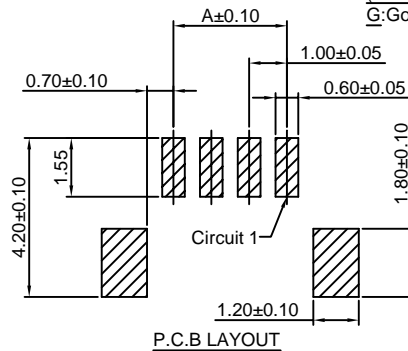
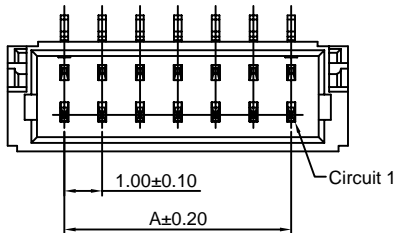
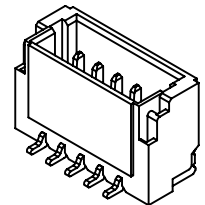

Ordering Information & Dimensions:

PART NO.	Dimensions	
	A	B
2P	1.00	4.00
3P	2.00	5.00
4P	3.00	6.00
5P	4.00	7.00
6P	5.00	8.00
7P	6.00	9.00
8P	7.00	10.00
9P	8.00	11.00
10P	9.00	12.00
11P	10.00	13.00
12P	11.00	14.00
13P	12.00	15.00
14P	13.00	16.00
15P	14.00	17.00
16P	15.00	18.00
17P	16.00	19.00
18P	17.00	20.00
19P	18.00	21.00
20P	19.00	22.00

Unit: mm

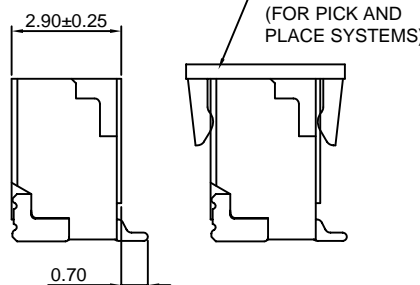
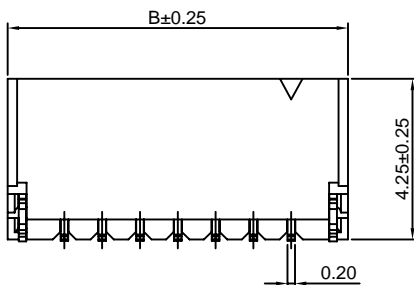

A1002WR-S-XP

1.00mm pitch 90° Single Row Wafer - SMT TYPE

Reference Informations:

- *Material: Pin: Phosphor Bronze/Tin over Nickel
Solder Tabs: Phosphor Bronze/Tin over Nickel
Insulator: Nylon 6T, UL94V-0
- *Mates with CJT A1002H-XP(-2) series Single Row Housing
- *Color: Ivory

Ordering Information:

A1002WR-S-XP - *** - **
1 2 3

- 1. Part No.
- 2. Material:
(Blank): Nylon 6T, UL94V-0
GWT: Nylon 6T, UL94V-0, GWT 750 °C
- 3. Finish:
(Blank): Tin over Nickel
G: Gold over Nickel

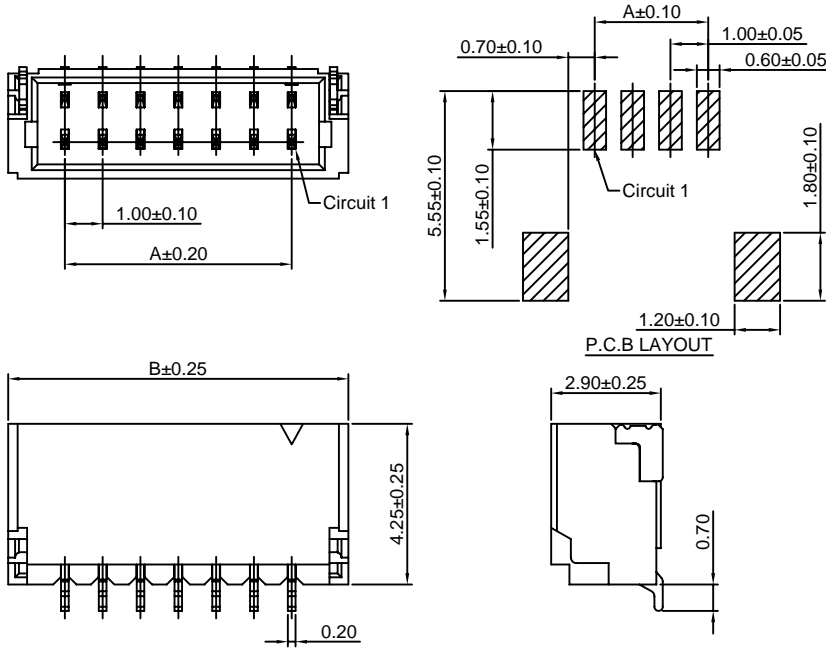
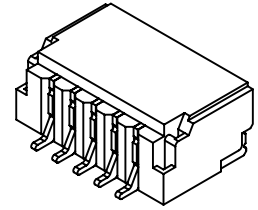

Ordering Information & Dimensions:

PART NO.	Dimensions	
	A	B
2P	1.00	4.00
3P	2.00	5.00
4P	3.00	6.00
5P	4.00	7.00
6P	5.00	8.00
7P	6.00	9.00
8P	7.00	10.00
9P	8.00	11.00
10P	9.00	12.00
11P	10.00	13.00
12P	11.00	14.00
13P	12.00	15.00
14P	13.00	16.00
15P	14.00	17.00
16P	15.00	18.00
17P	16.00	19.00
18P	17.00	20.00
19P	18.00	21.00
20P	19.00	22.00

Unit: mm

A1002WRA-S-XP

1.00mm pitch 90° Single Row Wafer - SMT TYPE

Reference Informations:

- *Material: Pin: Brass/Tin over Nickel
Solder Tabs: Brass/Tin over Nickel
Insulator: Nylon 6T, UL94V-0
- *Mates with CJT A1002HA-XP series Single Row Housing
- *Color: Ivory

Ordering Information:

A1002WRA-S-XP - *** - **
1 2 3

- 1. Part No.
- 2. Material:
(Blank): Nylon 6T, UL94V-0
GWT: Nylon 6T, UL94V-0, GWT 750 °C
- 3. Finish:
(Blank): Tin over Nickel
G: Gold over Nickel

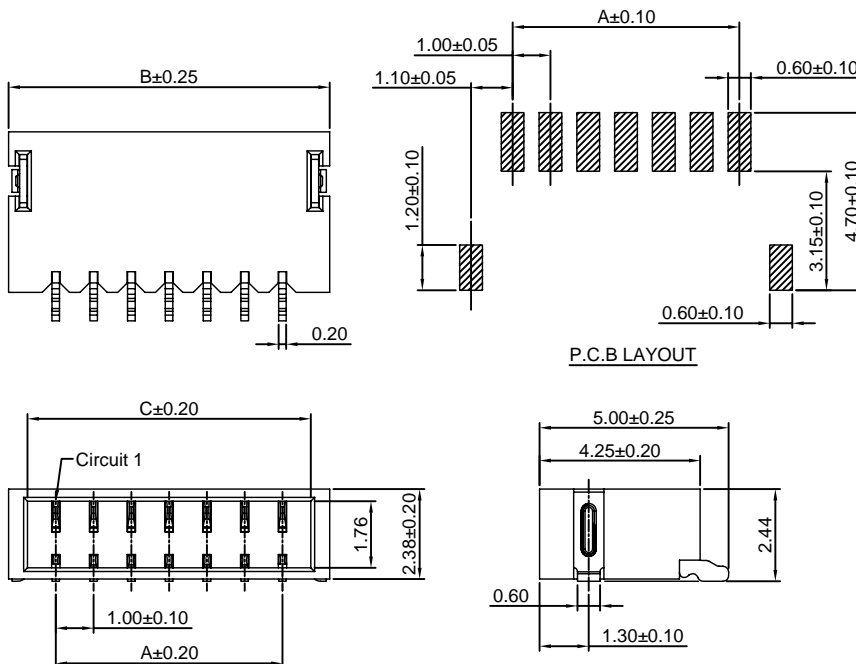

Ordering Information & Dimensions:

PART NO.	Dimensions		
	A	B	C
2P	1.00	3.50	2.50
3P	2.00	4.50	3.50
4P	3.00	5.50	4.50
5P	4.00	6.50	5.50
6P	5.00	7.50	6.50
7P	6.00	8.50	7.50
8P	7.00	9.50	8.50
9P	8.00	10.50	9.50
10P	9.00	11.50	10.50
11P	10.00	12.50	11.50
12P	11.00	13.50	12.50
13P	12.00	14.50	13.50
14P	13.00	15.50	14.50
15P	14.00	16.50	15.50
16P	15.00	17.50	16.50
17P	16.00	18.50	17.50
18P	17.00	19.50	18.50
19P	18.00	20.50	19.50
20P	19.00	21.50	20.50

Unit: mm

A1002WVB-S-XP

1.00mm pitch 180° Single Row Wafer - SMT TYPE

Reference Informations:

- *Material: Pin: Phosphor Bronze/Tin over Nickel
Solder Tabs: Phosphor Bronze/Tin over Nickel
Insulator: Nylon 9T, UL94V-0
- *Mates with CJT A1002HB-XP series Single Row Housing
- *Color: Ivory

Ordering Information:

- A1002WVB-S-2xXP - *** - **
 $\frac{1}{2} \frac{3}{3}$
1. Part No.
 2. Material:
(Blank): Nylon 9T, UL94V-0
GWT: Nylon 9T, UL94V-0, GWT 750 °C
 3. Finish:
(Blank): Tin over Nickel
G: Gold over Nickel

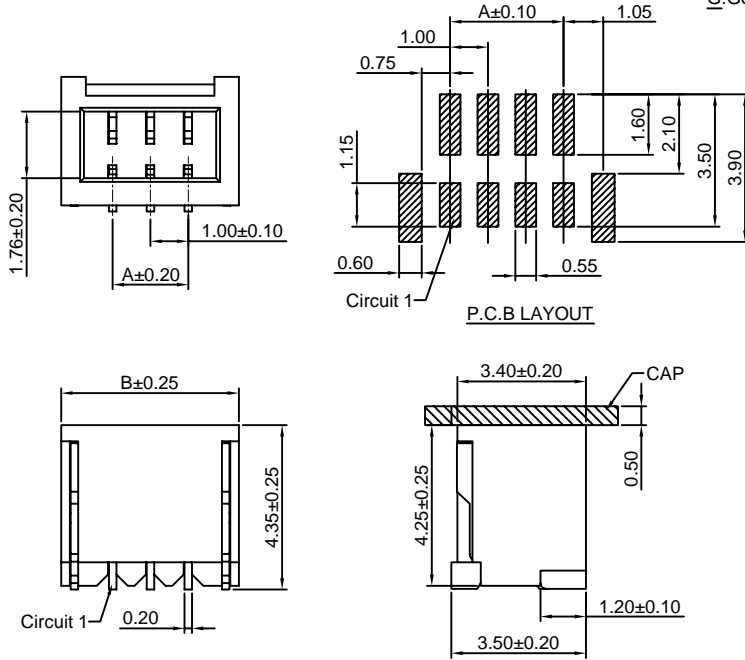
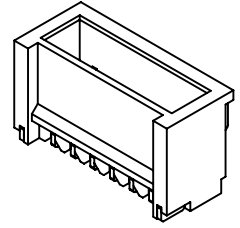

Ordering Information & Dimensions:

PART NO.	Dimensions	
	A	B
2P	1.00	3.70
3P	2.00	4.70
4P	3.00	5.70
5P	4.00	6.70
6P	5.00	7.70
7P	6.00	8.70
8P	7.00	9.70
9P	8.00	10.70
10P	9.00	11.70
11P	10.00	12.70
12P	11.00	13.70
13P	12.00	14.70
14P	13.00	15.70
15P	14.00	16.70
16P	15.00	17.70
17P	16.00	18.70
18P	17.00	19.70
19P	18.00	20.70
20P	19.00	21.70

Unit: mm

A1002WRB-S-XP

1.00mm pitch 90° Single Row Wafer - SMT TYPE

Reference Informations:

- *Material: Pin: Phosphor Bronze/Tin over Nickel
Solder Tabs: Phosphor Bronze/Tin over Nickel
Insulator: Nylon 9T, UL94V-0
- *Mates with CJT A1002HB-XP series Single Row Housing
- *Color: Ivory

Ordering Information:

- A1002WRB-S-2xXP - *** - **
 $\frac{1}{2} \frac{3}{3}$
1. Part No.
 2. Material:
(Blank): Nylon 9T, UL94V-0
GWT: Nylon 9T, UL94V-0, GWT 750 °C
 3. Finish:
(Blank): Tin over Nickel
G: Gold over Nickel

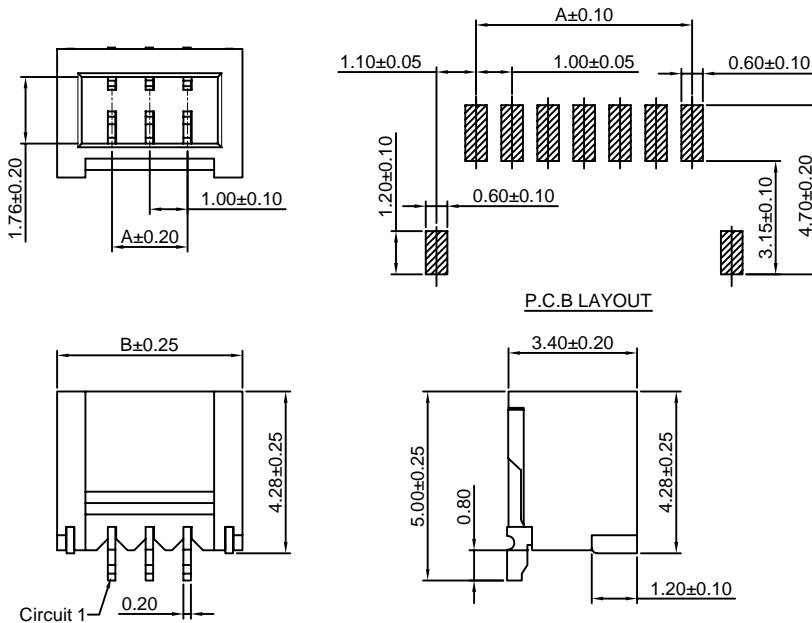
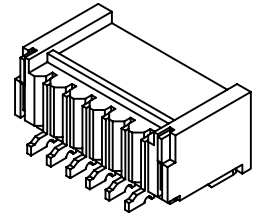

Ordering Information & Dimensions:

PART NO.	Dimensions	
	A	B
2P	1.00	3.70
3P	2.00	4.70
4P	3.00	5.70
5P	4.00	6.70
6P	5.00	7.70
7P	6.00	8.70
8P	7.00	9.70
9P	8.00	10.70
10P	9.00	11.70
11P	10.00	12.70
12P	11.00	13.70
13P	12.00	14.70
14P	13.00	15.70
15P	14.00	16.70
16P	15.00	17.70
17P	16.00	18.70
18P	17.00	19.70
19P	18.00	20.70
20P	19.00	21.70

Unit: mm

A1002WRC-S-XP

1.00mm pitch 90° Single Row Wafer - SMT TYPE

Reference Informations:

- *Material: Pin: Brass/Tin over Nickel
Solder Tabs: Brass/Tin over Nickel
Insulator: Nylon 9T, UL94V-0
- *Mates with CJT A1002HE-XP series Single Row Housing
- *Color: Ivory

Ordering Information:

- A1002WRC-S-2xXP - *** - **
- 1 2 3
1. Part No.
 2. Material:
(Blank): Nylon 9T, UL94V-0
GWT: Nylon 9T, UL94V-0, GWT 750 °C
 3. Finish:
(Blank): Tin over Nickel
G: Gold over Nickel

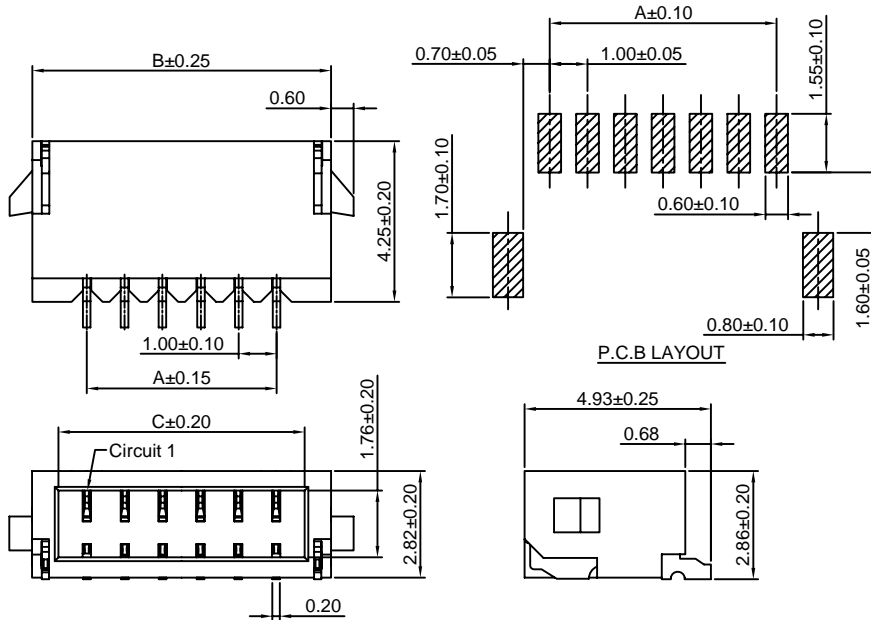
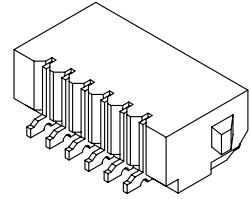

Ordering Information & Dimensions:

PART NO.	Dimensions		
	A	B	C
2P	1.00	3.90	2.50
3P	2.00	4.90	3.50
4P	3.00	5.90	4.50
5P	4.00	6.90	5.50
6P	5.00	7.90	6.50
7P	6.00	8.90	7.50
8P	7.00	9.90	8.50
9P	8.00	10.90	9.50
10P	9.00	11.90	10.50
11P	10.00	12.90	11.50
12P	11.00	13.90	12.50
13P	12.00	14.90	13.50
14P	13.00	15.90	14.50
15P	14.00	16.90	15.50
16P	15.00	17.90	16.50
17P	16.00	18.90	17.50
18P	17.00	19.90	18.50
19P	18.00	20.90	19.50
20P	19.00	21.90	20.50

Unit:mm

A1002WRD-S-XP

1.00mm pitch 90° Single Row Wafer - SMT TYPE

Reference Informations:

- *Material: Pin: Brass/Tin over Nickel
Solder Tabs: Brass/Tin over Nickel
Insulator: Nylon 9T, UL94V-0
- *Mates with CJT A1002HG, HI-XP series Single Row Housing
- *Color: Ivory

Ordering Information:

- A1002WRD-S-2xXP - *** - **
- 1 2 3
1. Part No.
 2. Material:
(Blank): Nylon 9T, UL94V-0
GWT: Nylon 9T, UL94V-0, GWT 750 °C
 3. Finish:
(Blank): Tin over Nickel
G: Gold over Nickel

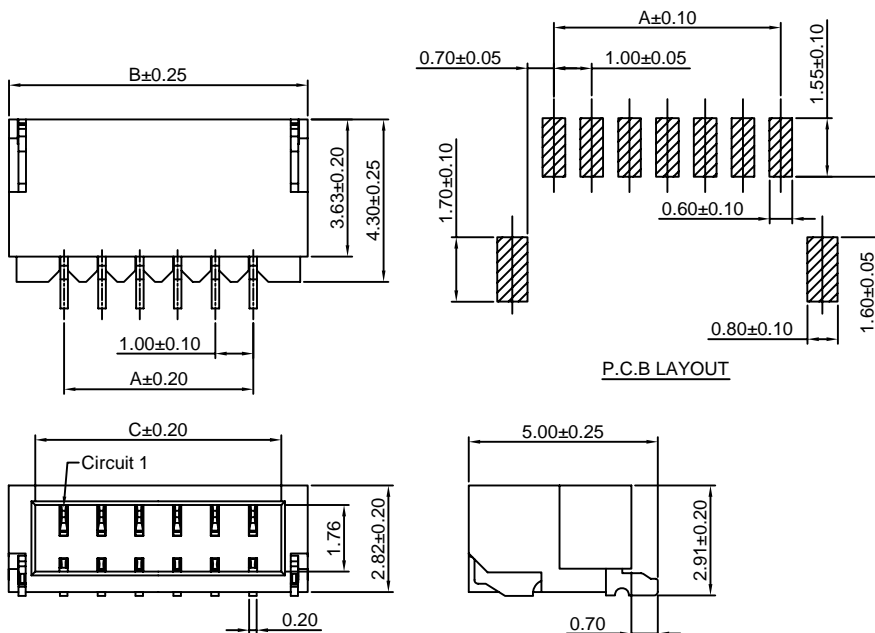

Ordering Information & Dimensions:

PART NO.	Dimensions		
	A	B	C
2P	1.00	3.90	2.50
3P	2.00	4.90	3.50
4P	3.00	5.90	4.50
5P	4.00	6.90	5.50
6P	5.00	7.90	6.50
7P	6.00	8.90	7.50
8P	7.00	9.90	8.50
9P	8.00	10.90	9.50
10P	9.00	11.90	10.50
11P	10.00	12.90	11.50
12P	11.00	13.90	12.50
13P	12.00	14.90	13.50
14P	13.00	15.90	14.50
15P	14.00	16.90	15.50
16P	15.00	17.90	16.50
17P	16.00	18.90	17.50
18P	17.00	19.90	18.50
19P	18.00	20.90	19.50
20P	19.00	21.90	20.50

Unit:mm

A1002WV-S-2xXP

1.00mm pitch 180° Dual Row Wafer - SMT TYPE

Reference Informations:

- *Material: Pin: Phosphor Bronze/Tin over Nickel
Solder Tabs: Phosphor Bronze/Tin over Nickel
Insulator: Nylon 6T, UL94V-0
- *Mates with CJT A1002H-2xXP series Dual Row Housing
- *Color: Ivory

- Ordering Information:
A1002WV-S-2xXP - *** - **
1 2 3
1. Part No.
 2. Material:
(Blank): Nylon 6T, UL94V-0
GWT: Nylon 6T, UL94V-0, GWT 750 °C
 3. Finish:
(Blank): Tin over Nickel
G: Gold over Nickel

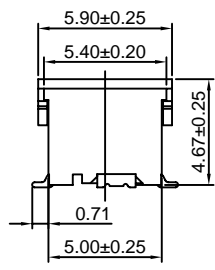
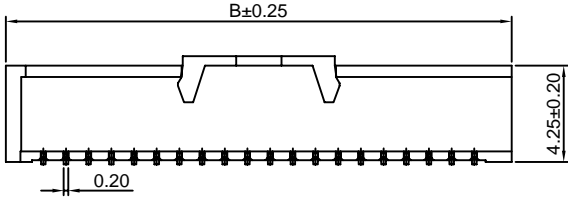
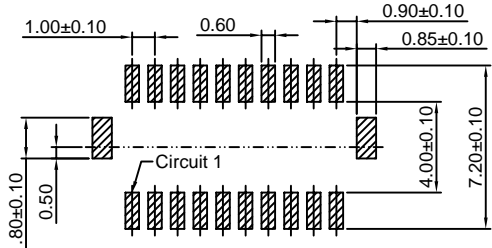
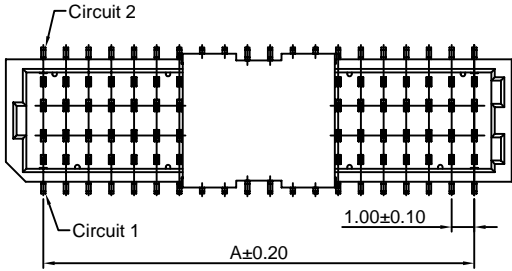
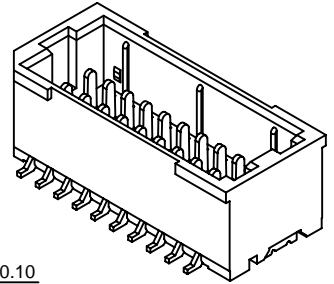

Ordering Information & Dimensions:

PART NO.	Dimensions	
	A	B
2x6P	5.00	8.30
2x8P	7.00	10.30
2x10P	9.00	12.30
2x15P	14.00	17.30
2x20P	19.00	22.30
2x25P	24.00	27.30

Unit: mm

A1002WR-S-2xXP

1.00mm pitch 90° Dual Row Wafer - SMT TYPE

Reference Informations:

- *Material: Pin: Phosphor Bronze/Tin over Nickel
Solder Tabs: Phosphor Bronze/Tin over Nickel
Insulator: Nylon 6T, UL94V-0
- *Mates with CJT A1002H-2xXP series Dual Row Housing
- *Color: Ivory

- Ordering Information:
A1002WR-S-2xXP - *** - **
1 2 3
1. Part No.
 2. Material:
(Blank): Nylon 6T, UL94V-0
GWT: Nylon 6T, UL94V-0, GWT 750 °C
 3. Finish:
(Blank): Tin over Nickel
G: Gold over Nickel

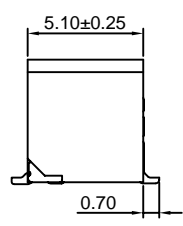
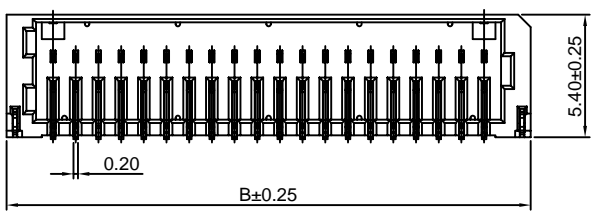
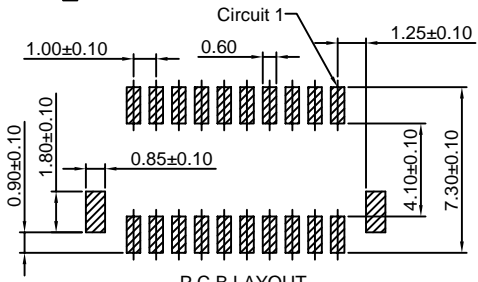
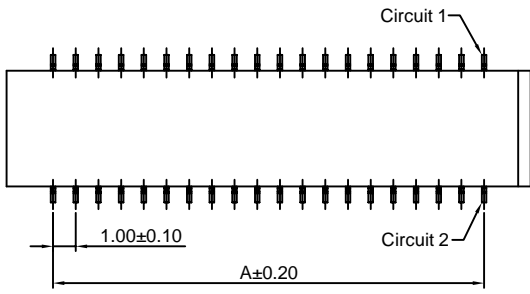
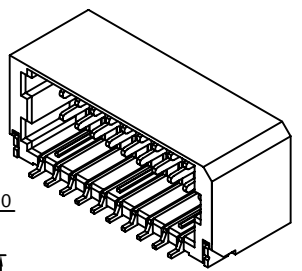

Ordering Information & Dimensions:

PART NO.	Dimensions	
	A	B
2x6P	5.00	8.30
2x8P	7.00	10.30
2x10P	9.00	12.30
2x15P	14.00	17.30
2x20P	19.00	22.30
2x25P	24.00	27.30

Unit: mm

X-ON Electronics

Largest Supplier of Electrical and Electronic Components

Click to view similar products for [Headers & Wire Housings](#) category:

Click to view products by [Changjiang](#) manufacturer:

Other Similar products are found below :

[95000-104TRLF](#) [10135584-644402LF](#) [DF62W-EP2022PCA](#) [95000-106TRLF](#) [DF62W-2022SCA](#) [DF62W-EP2022PC](#) [2203348](#) [DF62W-2022SC](#) [1084018](#) [1029039](#) [1084017](#) [802-10-012-10-002000](#) [1112640](#) [1112639](#) [891-007-9SS-BST1T](#) [000-34000](#) [0008550134](#) [0009482033](#) [0009507031](#) [57102-F02-18ULF](#) [57102-S06-03LF](#) [57202-S52-04LF](#) [PCN6-15S-2.5E](#) [0039019024](#) [58102-G61-06LF](#) [582553-1](#) [0009485154](#) [0009508121](#) [0022285053](#) [0050291907](#) [018731A](#) [LY20-4P-DT1-P1E-BR](#) [02.125.8002.8](#) [60101931](#) [60598-1 \(Cut Strip\)](#) [M1625-3R/100](#) [61062-3](#) [61082-181009](#) [CSU011177004](#) [636-1427](#) [638009-1](#) [641938-9](#) [641991-4](#) [644168-1](#) [644827-2](#) [647662-1](#) [65039-019ELF](#) [65692-001LF](#) [65781-018](#) [65781-047](#)