

### Specifications

- Current rating:1A AC,DC
- Voltage rating:50V AC,DC
- Temperature range:-40°C~+105°C
- Contact resistance:20mΩMax.
- Insulation resistance:100MΩMin.
- Withstanding voltage:500V AC/minute
- \*Compliant with RoHS and REACH\*
- \*Meet the HF/Halogen Free,need to customize\*
- \*Contact CJT for details\*

### Standards

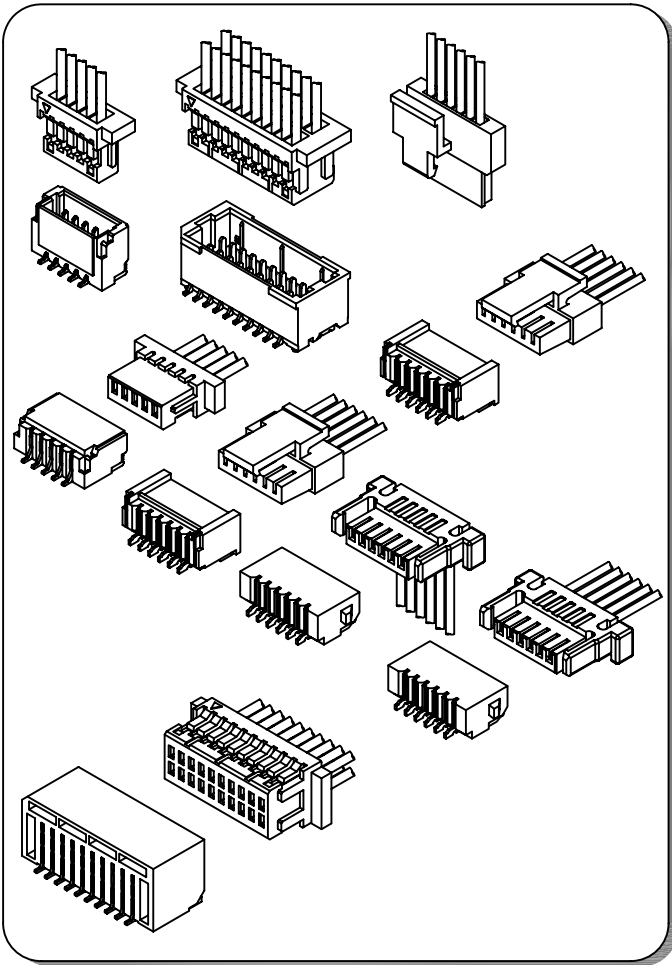

### Assembly layout

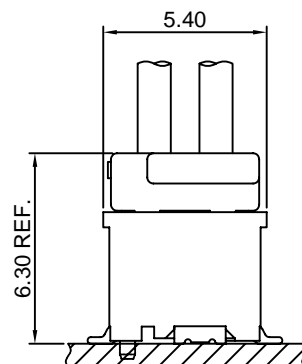
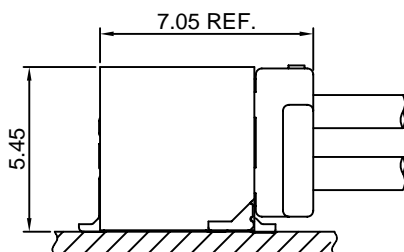
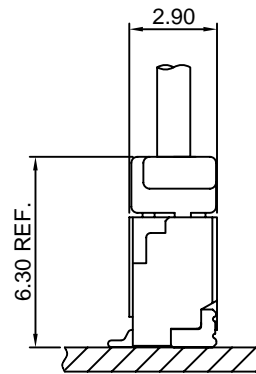
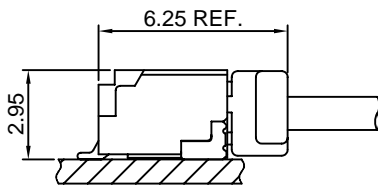

## A1002-T

1.00mm pitch Crimp Terminal

### Reference Informations:

\*Used in CJT A1002H , A1002H-2 series Housing

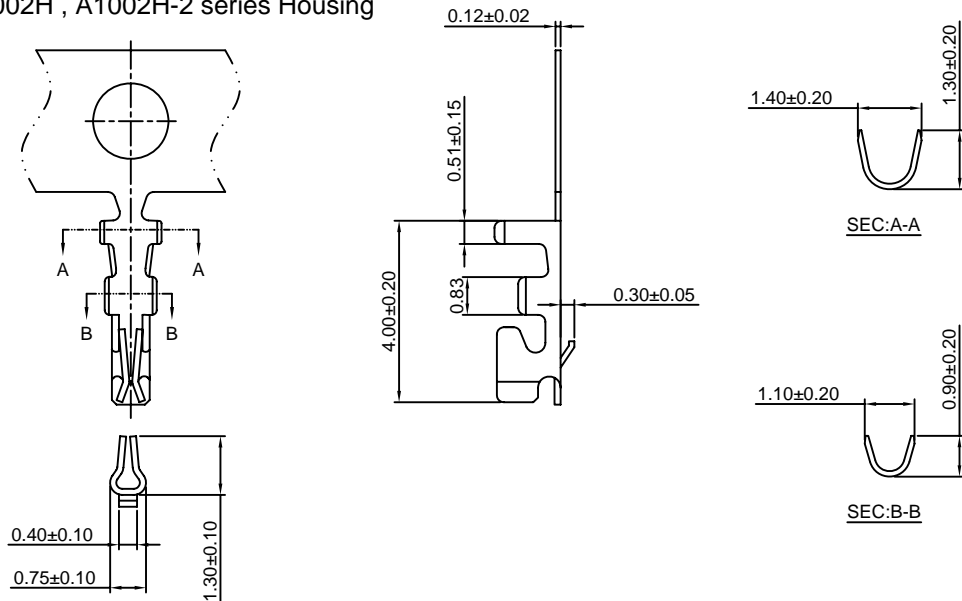

Ordering information & Specifications:

Unit:mm

Part NO.	Wire Range	Insulation O.D.	Material	Finish	Qty/reel
A1002-TP	AWG#28-#32	0.80mm(max)	Phosphor Bronze	Tin over Nickel	20,000 PCS
A1002-GP	AWG#28-#32	0.80mm(max)	Phosphor Bronze	Gold over flash	20,000 PCS

Optional Gold plating available but MOQ requested

## A1002A-T

1.00mm pitch Crimp Terminal

### Reference Informations:

\*Used in CJT A1002HA , A1002HB series Housing

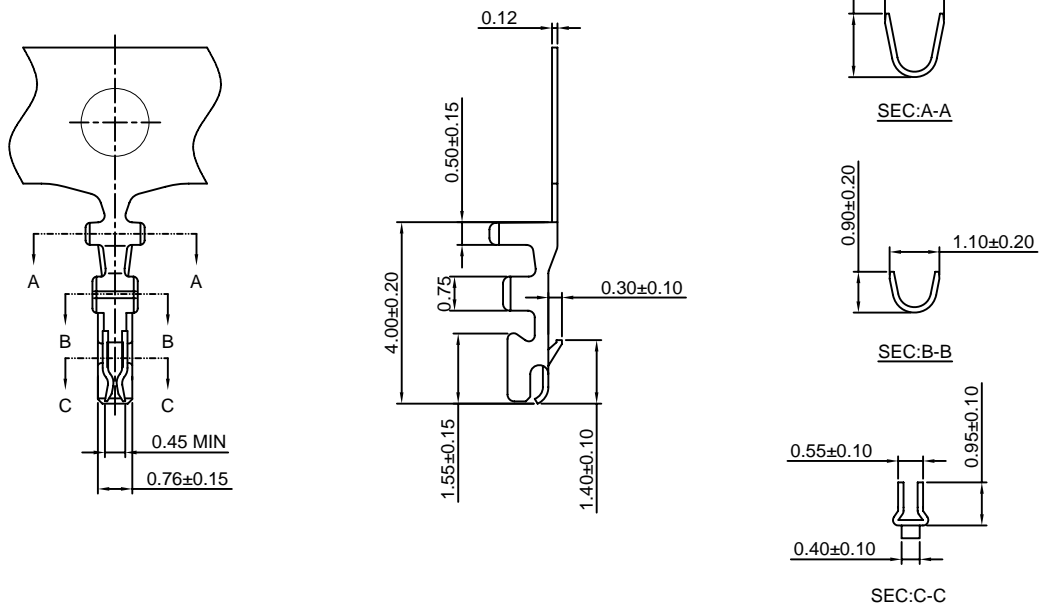

Ordering information & Specifications:

Unit:mm

Part NO.	Wire Range	Insulation O.D.	Material	Finish	Qty/reel
A1002A-TP	AWG#28-#32	0.80mm(max)	Phosphor Bronze	Tin over Nickel	20,000 PCS
A1002A-GP	AWG#28-#32	0.80mm(max)	Phosphor Bronze	Gold over flash	20,000 PCS

Optional Gold plating available but MOQ requested

## A1002C-T

1.00mm pitch Crimp Terminal

### Reference Informations:

\*Used in CJT A1002HC , A1002HD series Housing

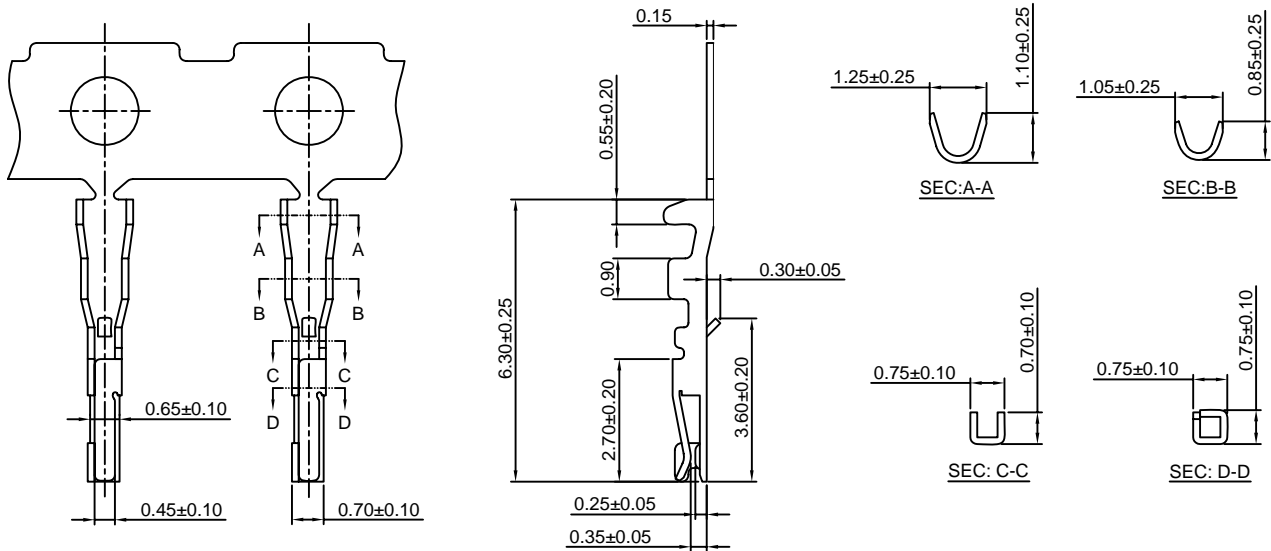

### Ordering information & Specifications:

Unit:mm

Part NO.	Wire Range	Insulation O.D.	Material	Finish	Qty/reel
A1002C-TP	AWG#28-#32	0.80mm(max)	Phosphor Bronze	Tin over Nickel	20,000 PCS
A1002C-GP	AWG#28-#32	0.80mm(max)	Phosphor Bronze	Gold over flash	20,000 PCS

Optional Gold plating available but MOQ requested

## A1002D-T

1.00mm pitch Crimp Terminal

### Reference Informations:

\*Used in CJT A1002HG,A1002HI series Housing

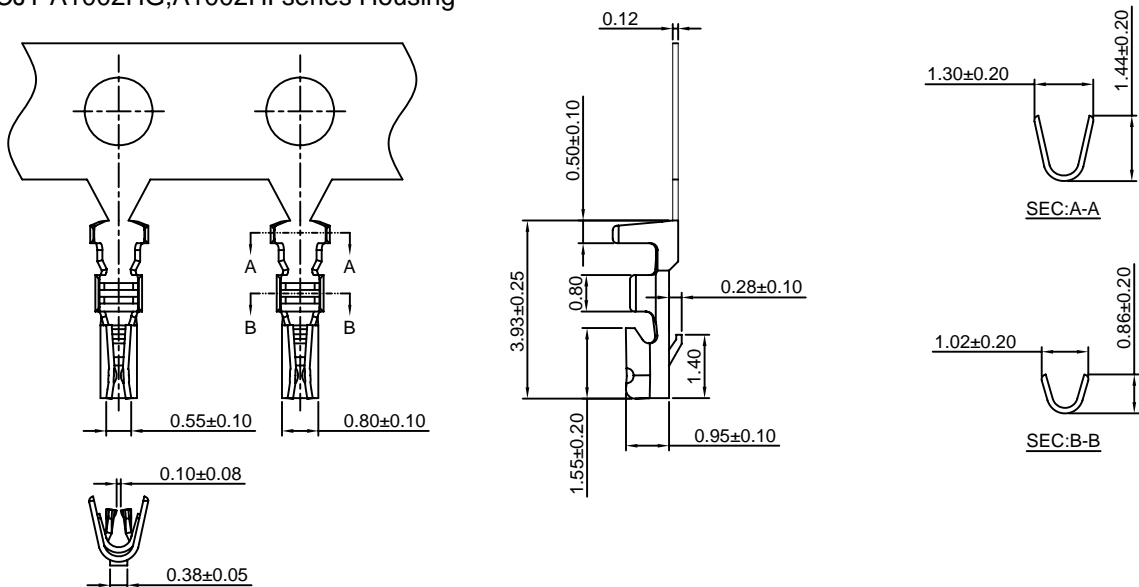

### Ordering information & Specifications:

Unit:mm

Part NO.	Wire Range	Insulation O.D.	Material	Finish	Qty/reel
A1002D-TP	AWG#28-#32	0.80mm(max)	Phosphor Bronze	Tin over Nickel	20,000 PCS
A1002D-GP	AWG#28-#32	0.80mm(max)	Phosphor Bronze	Gold over flash	20,000 PCS

Optional Gold plating available but MOQ requested

## A1002H

1.00mm pitch Single Row Housing

### Reference Informations:

- \*Material:PBT,UL94V-0
- \*Suitable CJT A1002 series Terminal
- \*Mates with CJT A1002 series Single Row Wafer
- \*Color:White

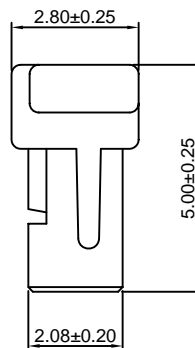
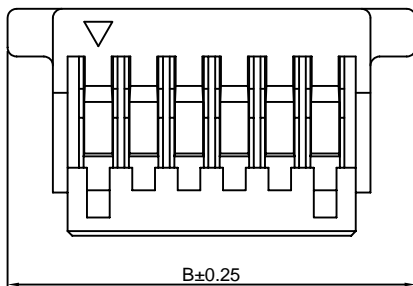
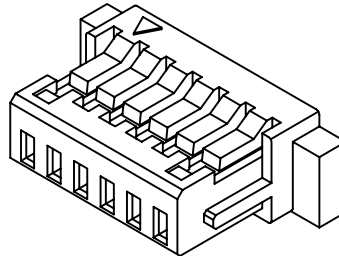
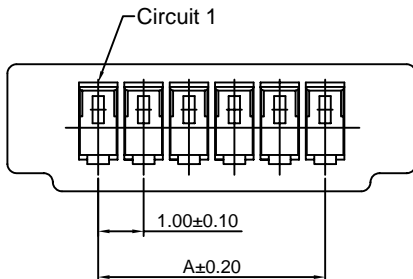

### Ordering Information & Dimensions:

PART NO.	Dimensions	
	A	B
A1002H-2P	1.00	5.00
A1002H-3P	2.00	6.00
A1002H-4P	3.00	7.00
A1002H-5P	4.00	8.00
A1002H-6P	5.00	9.00
A1002H-7P	6.00	10.00
A1002H-8P	7.00	11.00
A1002H-9P	8.00	12.00
A1002H-10P	9.00	13.00
A1002H-11P	10.00	14.00
A1002H-12P	11.00	15.00
A1002H-13P	12.00	16.00
A1002H-14P	13.00	17.00
A1002H-15P	14.00	18.00
A1002H-16P	15.00	19.00
A1002H-17P	16.00	20.00
A1002H-18P	17.00	21.00
A1002H-19P	18.00	22.00
A1002H-20P	19.00	23.00

Unit: mm

## A1002H-2

1.00mm pitch Single Row Housing

### Reference Informations:

- \*Material:PBT,UL94V-0
- \*Suitable CJT A1002 series Terminal
- \*Mates with CJT A1002 series Single Row Wafer
- \*Color:White

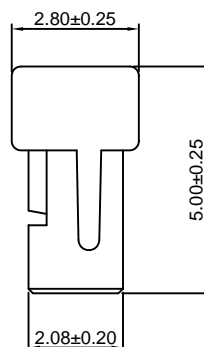
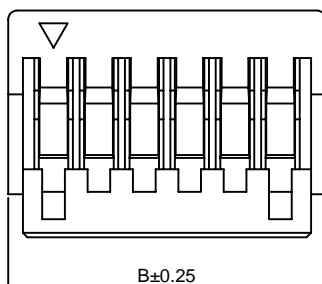
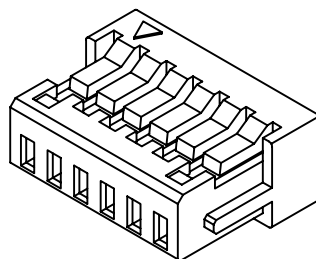
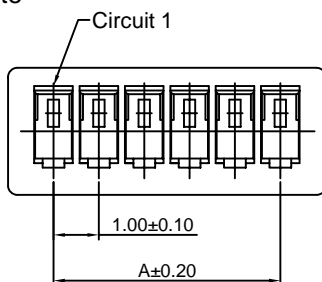

### Ordering Information & Dimensions:

PART NO.	Dimensions	
	A	B
A1002H-2P-2	1.00	3.00
A1002H-3P-2	2.00	4.00
A1002H-4P-2	3.00	5.00
A1002H-5P-2	4.00	6.00
A1002H-6P-2	5.00	7.00
A1002H-7P-2	6.00	8.00
A1002H-8P-2	7.00	9.00
A1002H-9P-2	8.00	10.00
A1002H-10P-2	9.00	11.00
A1002H-11P-2	10.00	12.00
A1002H-12P-2	11.00	13.00
A1002H-13P-2	12.00	14.00
A1002H-14P-2	13.00	15.00
A1002H-15P-2	14.00	16.00
A1002H-16P-2	15.00	17.00
A1002H-17P-2	16.00	18.00
A1002H-18P-2	17.00	19.00
A1002H-19P-2	18.00	20.00
A1002H-20P-2	19.00	21.00

Unit: mm

## A1002HA

1.00mm pitch Single Row Housing

### Reference Informations:

- \*Material:PBT,UL94V-0
- \*Suitable CJT A1002A series Terminal
- \*Mates with CJT A1002WVB-S,A1002WRA-S,A1002WRB-S series Wafer
- \*Color:White

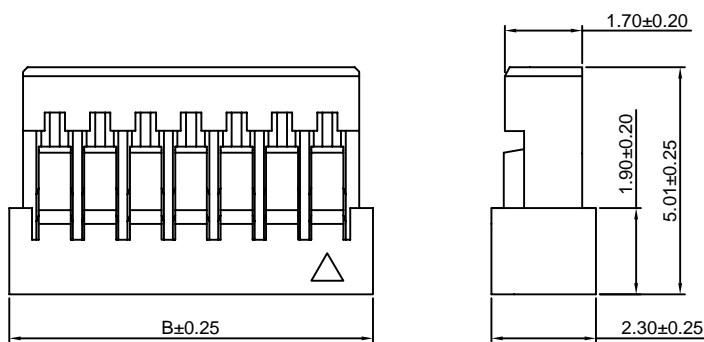
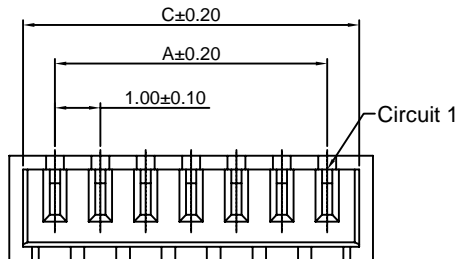
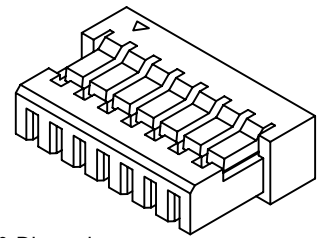

Ordering Information & Dimensions:

PART NO.	Dimensions		
	A	B	C
A1002HA-2P	1.00	3.00	2.40
A1002HA-3P	2.00	4.00	3.40
A1002HA-4P	3.00	5.00	4.40
A1002HA-5P	4.00	6.00	5.40
A1002HA-6P	5.00	7.00	6.40
A1002HA-7P	6.00	8.00	7.40
A1002HA-8P	7.00	9.00	8.40
A1002HA-9P	8.00	10.00	9.40
A1002HA-10P	9.00	11.00	10.40
A1002HA-11P	10.00	12.00	11.40
A1002HA-12P	11.00	13.00	12.40
A1002HA-13P	12.00	14.00	13.40
A1002HA-14P	13.00	15.00	14.40
A1002HA-15P	14.00	16.00	15.40
A1002HA-16P	15.00	17.00	16.40
A1002HA-17P	16.00	18.00	17.40
A1002HA-18P	17.00	19.00	18.40
A1002HA-19P	18.00	20.00	19.40
A1002HA-20P	19.00	21.00	20.40

Unit:mm

## A1002HB

1.00mm pitch Single Row Housing

### Reference Informations:

- \*Material:Nylon 66,UL94V-0
- \*Suitable CJT A1002A series Terminal
- \*Mates with CJT A1002WVB-S,A1002WRB-S Wafer
- \*Color:White

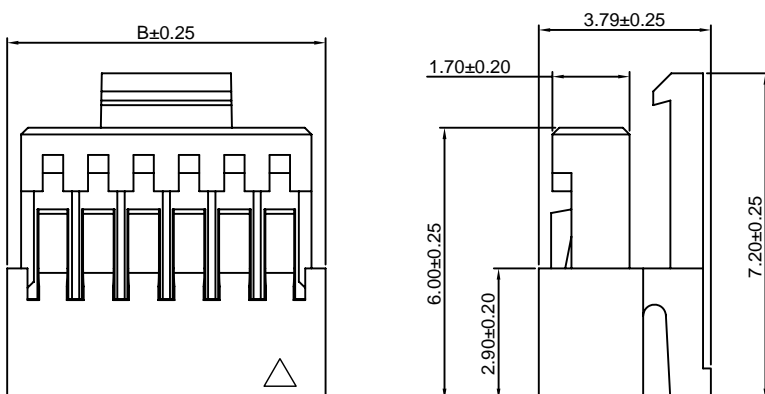
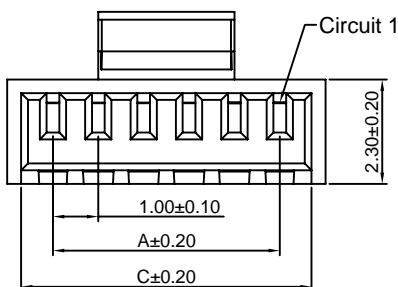
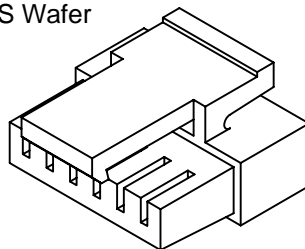

Ordering Information & Dimensions:

PART NO.	Dimensions		
	A	B	C
A1002HB-2P	1.00	3.00	2.40
A1002HB-3P	2.00	4.00	3.40
A1002HB-4P	3.00	5.00	4.40
A1002HB-5P	4.00	6.00	5.40
A1002HB-6P	5.00	7.00	6.40
A1002HB-7P	6.00	8.00	7.40
A1002HB-8P	7.00	9.00	8.40
A1002HB-9P	8.00	10.00	9.40
A1002HB-10P	9.00	11.00	10.40
A1002HB-11P	10.00	12.00	11.40
A1002HB-12P	11.00	13.00	12.40
A1002HB-13P	12.00	14.00	13.40
A1002HB-14P	13.00	15.00	14.40
A1002HB-15P	14.00	16.00	15.40
A1002HB-16P	15.00	17.00	16.40
A1002HB-17P	16.00	18.00	17.40
A1002HB-18P	17.00	19.00	18.40
A1002HB-19P	18.00	20.00	19.40
A1002HB-20P	19.00	21.00	20.40

Unit:mm

## A1002HC

1.00mm pitch Single Row Housing

### Reference Informations:

\*Material:Nylon 46,UL94V-0

\*Suitable CJT A1002C series Terminal

\*Color:Ivory

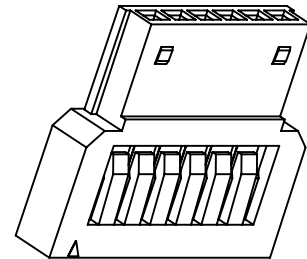
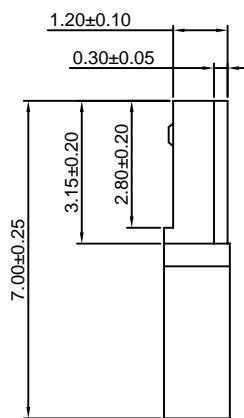
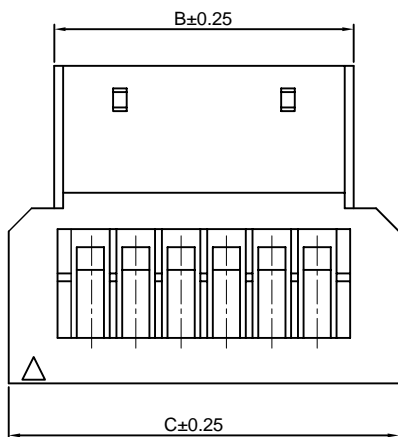
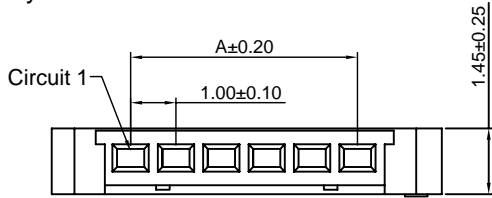

Ordering Information & Dimensions:

PART NO.	Dimensions		
	A	B	C
A1002HC-4P	3.00	4.60	6.60
A1002HC-6P	5.00	6.60	8.60

Unit:mm

## A1002HD

1.00mm pitch Single Row Housing

### Reference Informations:

\*Material:Nylon 46,UL94V-0

\*Suitable CJT A1002C series Terminal

\*Color:Ivory

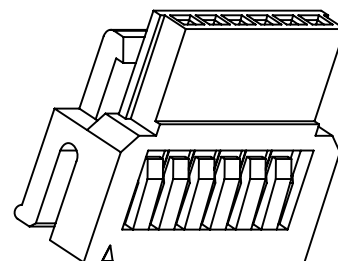
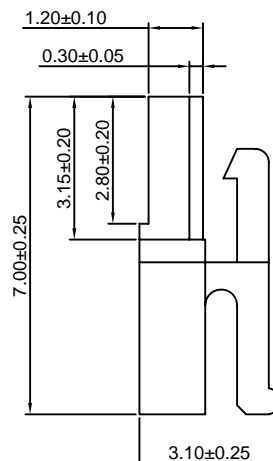
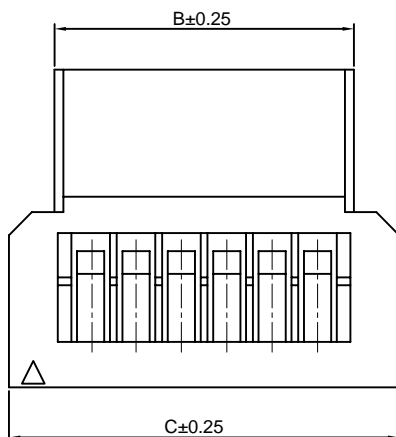
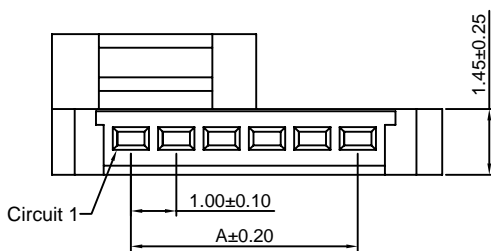

Ordering Information & Dimensions:

PART NO.	Dimensions		
	A	B	C
A1002HD-4P	3.00	4.60	6.60
A1002HD-6P	5.00	6.60	8.60

Unit:mm

### A1002HE

1.00mm pitch Single Row Housing

#### Reference Informations:

- \*Material:Nylon 66,UL94V-0
- \*Suitable CJT A1002A series Terminal
- \*Mates with CJT A1002WRC-S series Wafer
- \*Color:White

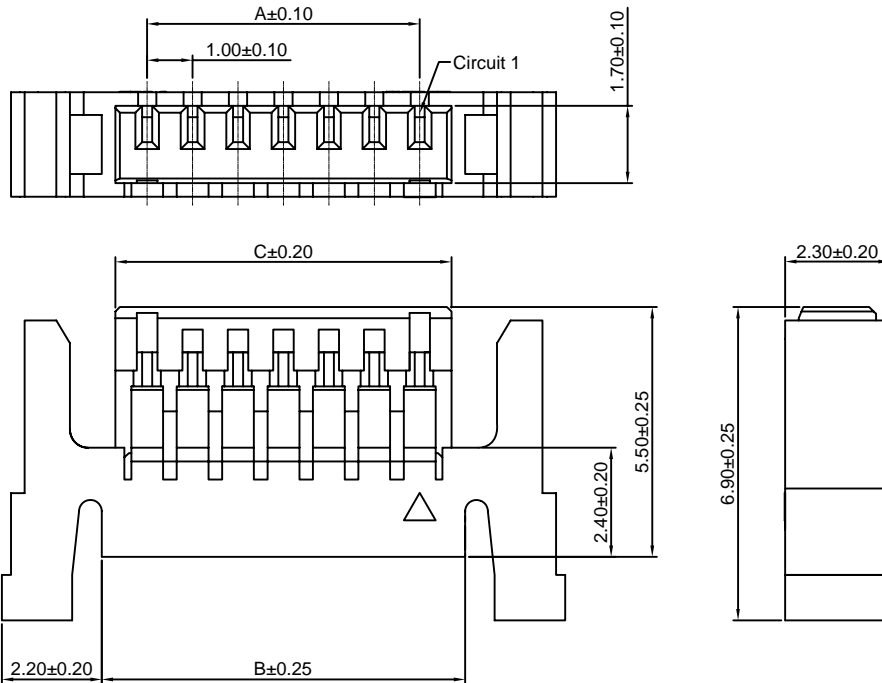

#### Ordering Information & Dimensions:

PART NO.	Dimensions		
	A	B	C
A1002HE-2P	1.00	3.00	2.40
A1002HE-3P	2.00	4.00	3.40
A1002HE-4P	3.00	5.00	4.40
A1002HE-5P	4.00	6.00	5.40
A1002HE-6P	5.00	7.00	6.40
A1002HE-7P	6.00	8.00	7.40
A1002HE-8P	7.00	9.00	8.40
A1002HE-9P	8.00	10.00	9.40
A1002HE-10P	9.00	11.00	10.40
A1002HE-11P	10.00	12.00	11.40
A1002HE-12P	11.00	13.00	12.40
A1002HE-13P	12.00	14.00	13.40
A1002HE-14P	13.00	15.00	14.40
A1002HE-15P	14.00	16.00	15.40
A1002HE-16P	15.00	17.00	16.40
A1002HE-17P	16.00	18.00	17.40
A1002HE-18P	17.00	19.00	18.40
A1002HE-19P	18.00	20.00	19.40
A1002HE-20P	19.00	21.00	20.40

Unit:mm

### A1002HG

1.00mm pitch 180° Single Row Housing

#### Reference Informations:

- \*Material:Nylon 66,UL94V-0
- \*Suitable CJT A1002D series Terminal
- \*Mates with CJT A1002WRD-S series Wafer
- \*Color:White

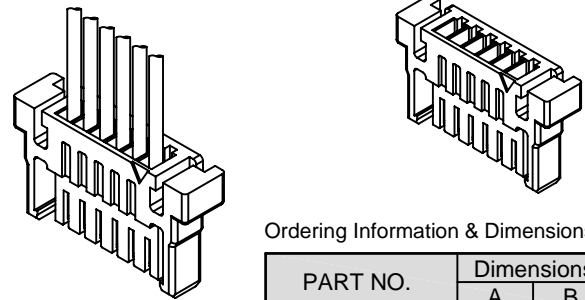
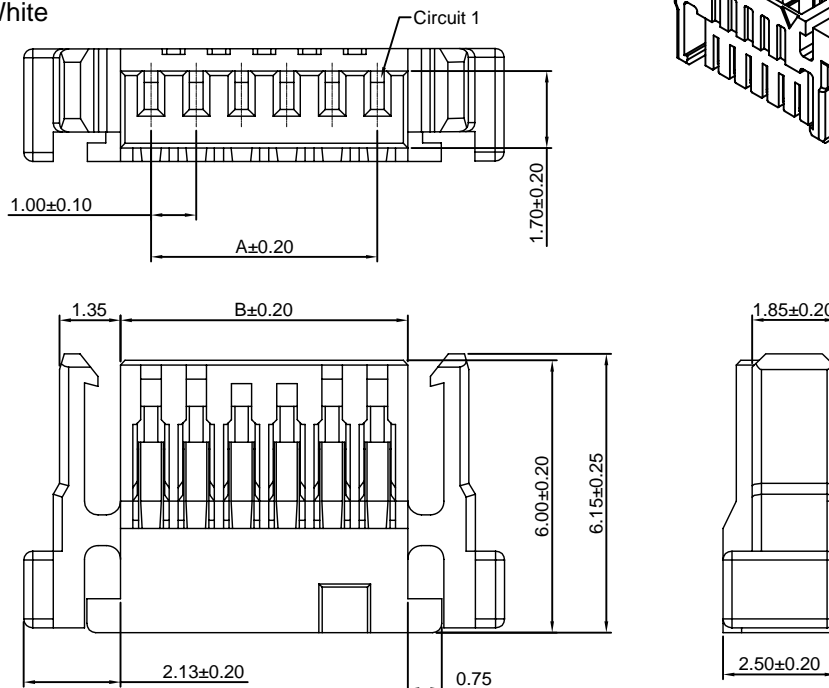

#### Ordering Information & Dimensions:

PART NO.	Dimensions	
	A	B
A1002HG-2P	1.00	2.30
A1002HG-3P	2.00	3.30
A1002HG-4P	3.00	4.30
A1002HG-5P	4.00	5.30
A1002HG-6P	5.00	6.30
A1002HG-7P	6.00	7.30
A1002HG-8P	7.00	8.30
A1002HG-9P	8.00	9.30
A1002HG-10P	9.00	10.30
A1002HG-11P	10.00	11.30
A1002HG-12P	11.00	12.30
A1002HG-13P	12.00	13.30
A1002HG-14P	13.00	14.30
A1002HG-15P	14.00	15.30
A1002HG-16P	15.00	16.30
A1002HG-17P	16.00	17.30
A1002HG-18P	17.00	18.30
A1002HG-19P	18.00	19.30
A1002HG-20P	19.00	20.30

Unit:mm

## A1002HI

1.00mm pitch 90° Single Row Housing

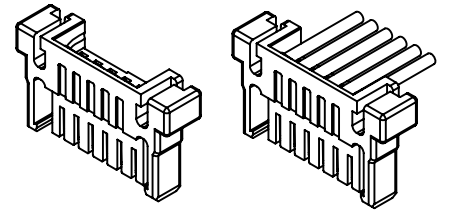

### Reference Informations:

- \*Material:Nylon 66,UL94V-0
- \*Suitable CJT A1002D series Terminal
- \*Mates with CJT A1002WRD-S series Wafer
- \*Color:White

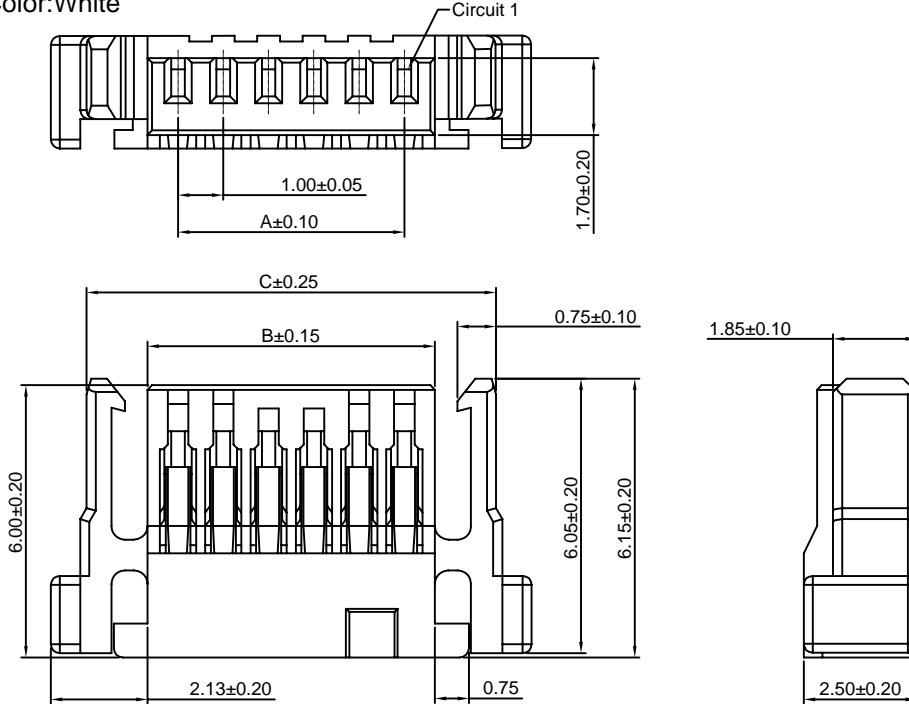

Ordering Information & Dimensions:

PART NO.	Dimensions	
	A	B
A1002HI-2P	1.00	2.30
A1002HI-3P	2.00	3.30
A1002HI-4P	3.00	4.30
A1002HI-5P	4.00	5.30
A1002HI-6P	5.00	6.30
A1002HI-7P	6.00	7.30
A1002HI-8P	7.00	8.30
A1002HI-9P	8.00	9.30
A1002HI-10P	9.00	10.30
A1002HI-11P	10.00	11.30
A1002HI-12P	11.00	12.30
A1002HI-13P	12.00	13.30
A1002HI-14P	13.00	14.30
A1002HI-15P	14.00	15.30
A1002HI-16P	15.00	16.30
A1002HI-17P	16.00	17.30
A1002HI-18P	17.00	18.30
A1002HI-19P	18.00	19.30
A1002HI-20P	19.00	20.30

Unit:mm

## A1002WRA-S

1.00mm pitch 90° Single Row Wafer - SMT TYPE

### Reference Informations:

- \*Material:Pin:Brass/Tin over Nickel  
Solder Tabs: Brass/Tin over Nickel  
Insulator:Nylon 6T,UL94V-0
- \*Mates with CJT A1002HA series Single Row Housing
- \*Color:Ivory

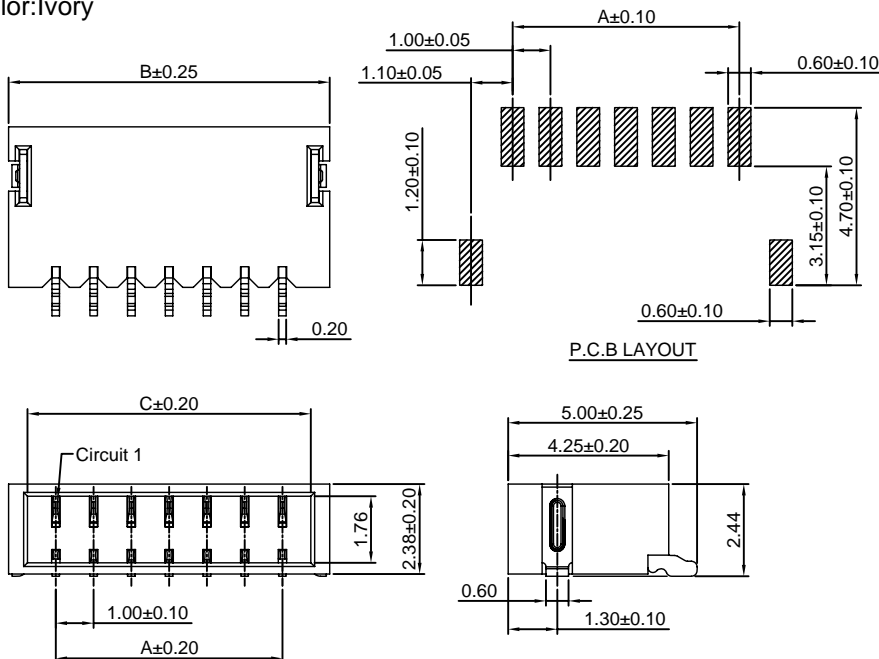

Ordering Information & Dimensions:

PART NO.	Dimensions		
	A	B	C
A1002WRA-2P	1.00	3.50	2.50
A1002WRA-3P	2.00	4.50	3.50
A1002WRA-4P	3.00	5.50	4.50
A1002WRA-5P	4.00	6.50	5.50
A1002WRA-6P	5.00	7.50	6.50
A1002WRA-7P	6.00	8.50	7.50
A1002WRA-8P	7.00	9.50	8.50
A1002WRA-9P	8.00	10.50	9.50
A1002WRA-10P	9.00	11.50	10.50
A1002WRA-11P	10.00	12.50	11.50
A1002WRA-12P	11.00	13.50	12.50
A1002WRA-13P	12.00	14.50	13.50
A1002WRA-14P	13.00	15.50	14.50
A1002WRA-15P	14.00	16.50	15.50
A1002WRA-16P	15.00	17.50	16.50
A1002WRA-17P	16.00	18.50	17.50
A1002WRA-18P	17.00	19.50	18.50
A1002WRA-19P	18.00	20.50	19.50
A1002WRA-20P	19.00	21.50	20.50

Unit:mm



## A1002WV-S

1.00mm pitch 180° Single Row Wafer - SMT TYPE

### Reference Informations:

- \*Material:Pin:Phosphor Bronze/Tin over Nickel  
Solder Tabs: Phosphor Bronze/Tin over Nickel  
Insulator:Nylon 6T,UL94V-0
- \*Mates with CJT A1002 series Single Row Housing
- \*Color:Ivory

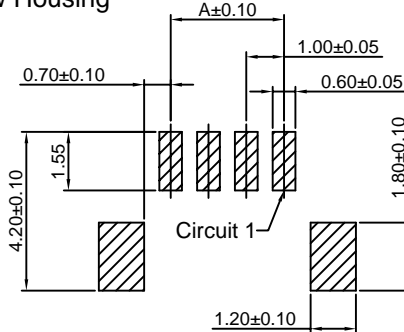
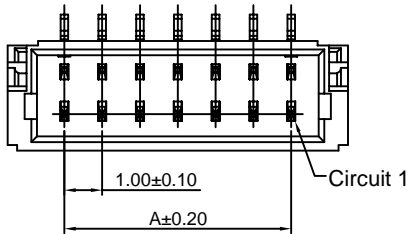
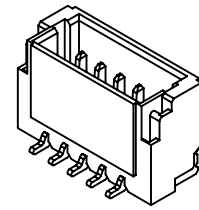

P.C.B LAYOUT

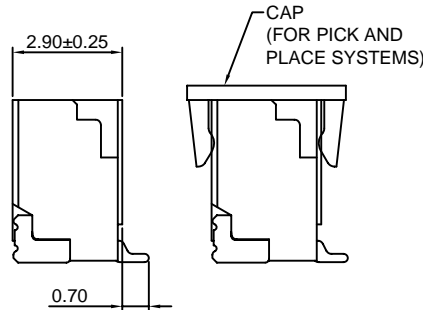
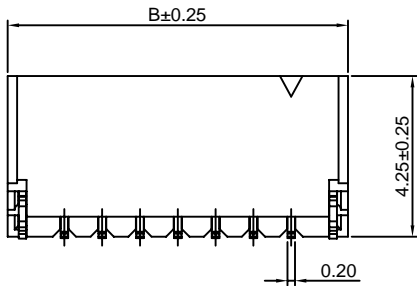

### Ordering Information & Dimensions:

PART NO.	Dimensions	
	A	B
A1002WV-S-2P	1.00	4.00
A1002WV-S-3P	2.00	5.00
A1002WV-S-4P	3.00	6.00
A1002WV-S-5P	4.00	7.00
A1002WV-S-6P	5.00	8.00
A1002WV-S-7P	6.00	9.00
A1002WV-S-8P	7.00	10.00
A1002WV-S-9P	8.00	11.00
A1002WV-S-10P	9.00	12.00
A1002WV-S-11P	10.00	13.00
A1002WV-S-12P	11.00	14.00
A1002WV-S-13P	12.00	15.00
A1002WV-S-14P	13.00	16.00
A1002WV-S-15P	14.00	17.00
A1002WV-S-16P	15.00	18.00
A1002WV-S-17P	16.00	19.00
A1002WV-S-18P	17.00	20.00
A1002WV-S-19P	18.00	21.00
A1002WV-S-20P	19.00	22.00

Unit: mm

## A1002WR-S

1.00mm pitch 90° Single Row Wafer - SMT TYPE

### Reference Informations:

- \*Material:Pin:Phosphor Bronze/Tin over Nickel  
Solder Tabs: Phosphor Bronze/Tin over Nickel  
Insulator:Nylon 6T,UL94V-0
- \*Mates with CJT A1002 series Single Row Housing
- \*Color:Ivory

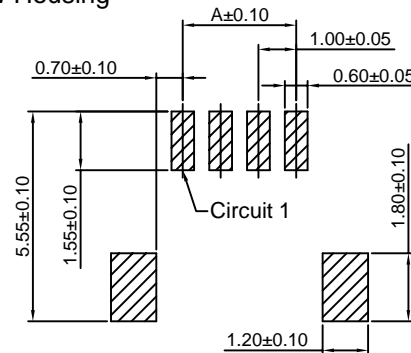
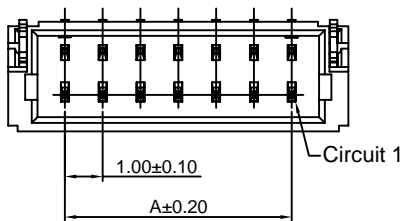
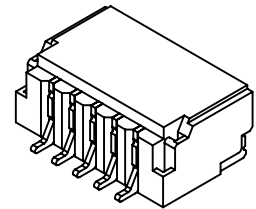

P.C.B LAYOUT

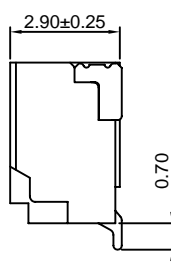
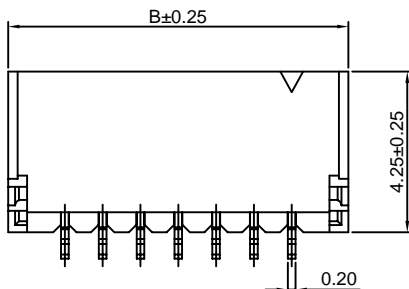

### Ordering Information & Dimensions:

PART NO.	Dimensions	
	A	B
A1002WR-S-2P	1.00	4.00
A1002WR-S-3P	2.00	5.00
A1002WR-S-4P	3.00	6.00
A1002WR-S-5P	4.00	7.00
A1002WR-S-6P	5.00	8.00
A1002WR-S-7P	6.00	9.00
A1002WR-S-8P	7.00	10.00
A1002WR-S-9P	8.00	11.00
A1002WR-S-10P	9.00	12.00
A1002WR-S-11P	10.00	13.00
A1002WR-S-12P	11.00	14.00
A1002WR-S-13P	12.00	15.00
A1002WR-S-14P	13.00	16.00
A1002WR-S-15P	14.00	17.00
A1002WR-S-16P	15.00	18.00
A1002WR-S-17P	16.00	19.00
A1002WR-S-18P	17.00	20.00
A1002WR-S-19P	18.00	21.00
A1002WR-S-20P	19.00	22.00

Unit: mm

### A1002WVB-S

1.00mm pitch 180° Single Row Wafer - SMT TYPE

#### Reference Informations:

- \*Material:Pin:Phosphor Bronze/Tin over Nickel  
Solder Tabs: Phosphor Bronze/Tin over Nickel  
Insulator:Nylon 9T,UL94V-0

\*Mates with CJT A1002HB series Single Row Housing

\*Color:Ivory

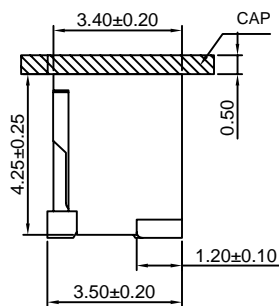
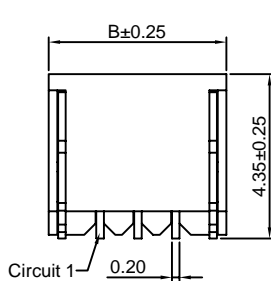
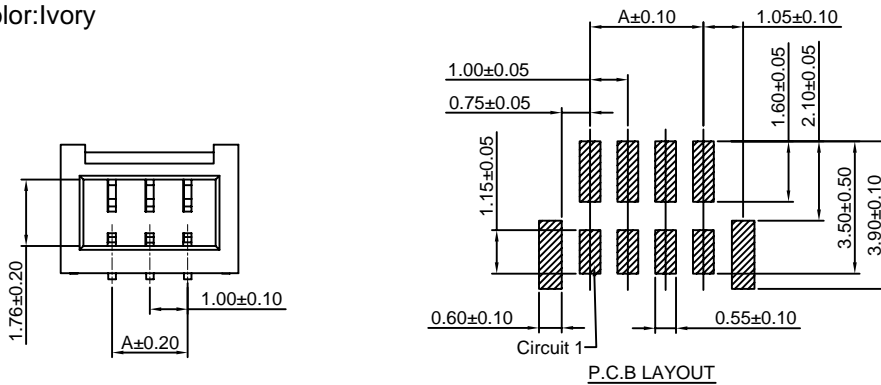
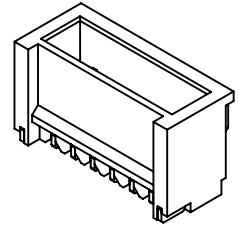

#### Ordering Information & Dimensions:

PART NO.	Dimensions	
	A	B
A1002WVB-S-2P	1.00	3.70
A1002WVB-S-3P	2.00	4.70
A1002WVB-S-4P	3.00	5.70
A1002WVB-S-5P	4.00	6.70
A1002WVB-S-6P	5.00	7.70
A1002WVB-S-7P	6.00	8.70
A1002WVB-S-8P	7.00	9.70
A1002WVB-S-9P	8.00	10.70
A1002WVB-S-10P	9.00	11.70
A1002WVB-S-11P	10.00	12.70
A1002WVB-S-12P	11.00	13.70
A1002WVB-S-13P	12.00	14.70
A1002WVB-S-14P	13.00	15.70
A1002WVB-S-15P	14.00	16.70
A1002WVB-S-16P	15.00	17.70
A1002WVB-S-17P	16.00	18.70
A1002WVB-S-18P	17.00	19.70
A1002WVB-S-19P	18.00	20.70
A1002WVB-S-20P	19.00	21.70

Unit: mm

### A1002WRB-S

1.00mm pitch 90° Single Row Wafer - SMT TYPE

#### Reference Informations:

- \*Material:Pin:Phosphor Bronze/Tin over Nickel  
Solder Tabs: Phosphor Bronze/Tin over Nickel  
Insulator:Nylon 9T,UL94V-0

\*Mates with CJT A1002HB series Single Row Housing

\*Color:Ivory

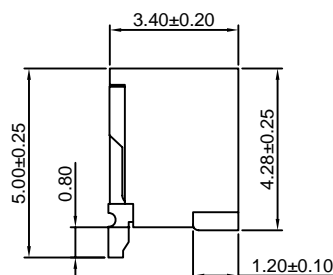
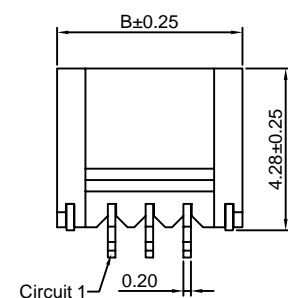
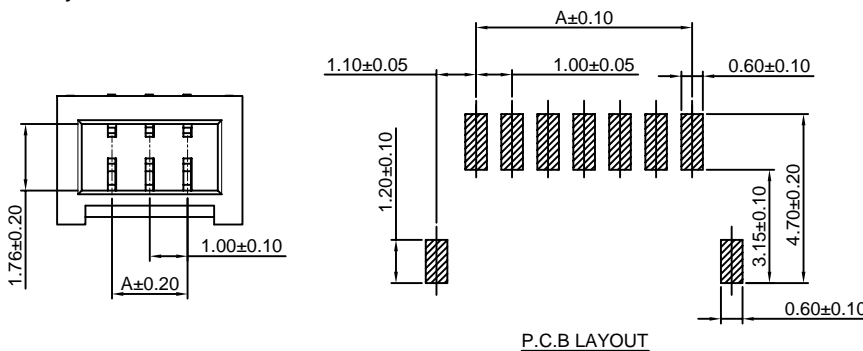
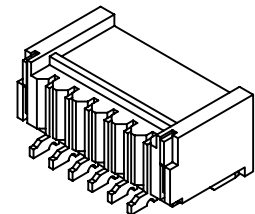

#### Ordering Information & Dimensions:

PART NO.	Dimensions	
	A	B
A1002WRB-S-2P	1.00	3.70
A1002WRB-S-3P	2.00	4.70
A1002WRB-S-4P	3.00	5.70
A1002WRB-S-5P	4.00	6.70
A1002WRB-S-6P	5.00	7.70
A1002WRB-S-7P	6.00	8.70
A1002WRB-S-8P	7.00	9.70
A1002WRB-S-9P	8.00	10.70
A1002WRB-S-10P	9.00	11.70
A1002WRB-S-11P	10.00	12.70
A1002WRB-S-12P	11.00	13.70
A1002WRB-S-13P	12.00	14.70
A1002WRB-S-14P	13.00	15.70
A1002WRB-S-15P	14.00	16.70
A1002WRB-S-16P	15.00	17.70
A1002WRB-S-17P	16.00	18.70
A1002WRB-S-18P	17.00	19.70
A1002WRB-S-19P	18.00	20.70
A1002WRB-S-20P	19.00	21.70

Unit: mm

### A1002WRC-S

1.00mm pitch 90° Single Row Wafer - SMT TYPE

#### Reference Informations:

- \*Material:Pin:Brass/Tin over Nickel  
Solder Tabs: Brass/Tin over Nickel  
Insulator:Nylon 9T,UL94V-0
- \*Mates with CJT A1002HE series Single Row Housing
- \*Color:Ivory

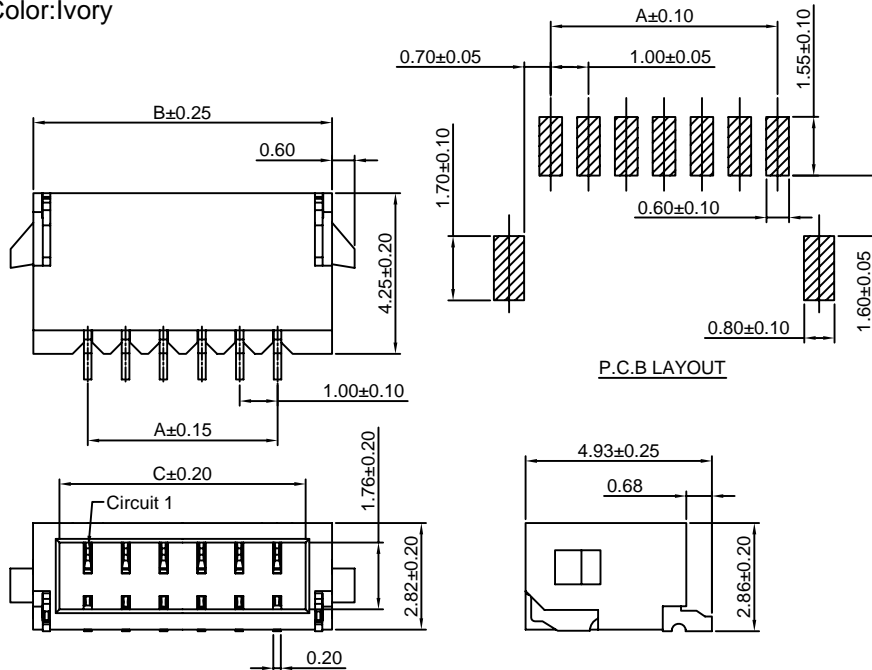
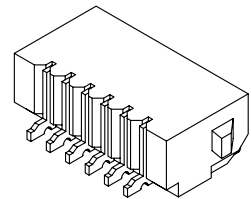

#### Ordering Information & Dimensions:

PART NO.	Dimensions		
	A	B	C
A1002WRC-2P	1.00	3.90	2.50
A1002WRC-3P	2.00	4.90	3.50
A1002WRC-4P	3.00	5.90	4.50
A1002WRC-5P	4.00	6.90	5.50
A1002WRC-6P	5.00	7.90	6.50
A1002WRC-7P	6.00	8.90	7.50
A1002WRC-8P	7.00	9.90	8.50
A1002WRC-9P	8.00	10.90	9.50
A1002WRC-10P	9.00	11.90	10.50
A1002WRC-11P	10.00	12.90	11.50
A1002WRC-12P	11.00	13.90	12.50
A1002WRC-13P	12.00	14.90	13.50
A1002WRC-14P	13.00	15.90	14.50
A1002WRC-15P	14.00	16.90	15.50
A1002WRC-16P	15.00	17.90	16.50
A1002WRC-17P	16.00	18.90	17.50
A1002WRC-18P	17.00	19.90	18.50
A1002WRC-19P	18.00	20.90	19.50
A1002WRC-20P	19.00	21.90	20.50

Unit:mm

### A1002WRD-S

1.00mm pitch 90° Single Row Wafer - SMT TYPE

#### Reference Informations:

- \*Material:Pin:Brass/Tin over Nickel  
Solder Tabs: Brass/Tin over Nickel  
Insulator:Nylon 9T,UL94V-0
- \*Mates with CJT A1002HG , A1002HI series Single Row Housing
- \*Color:Ivory

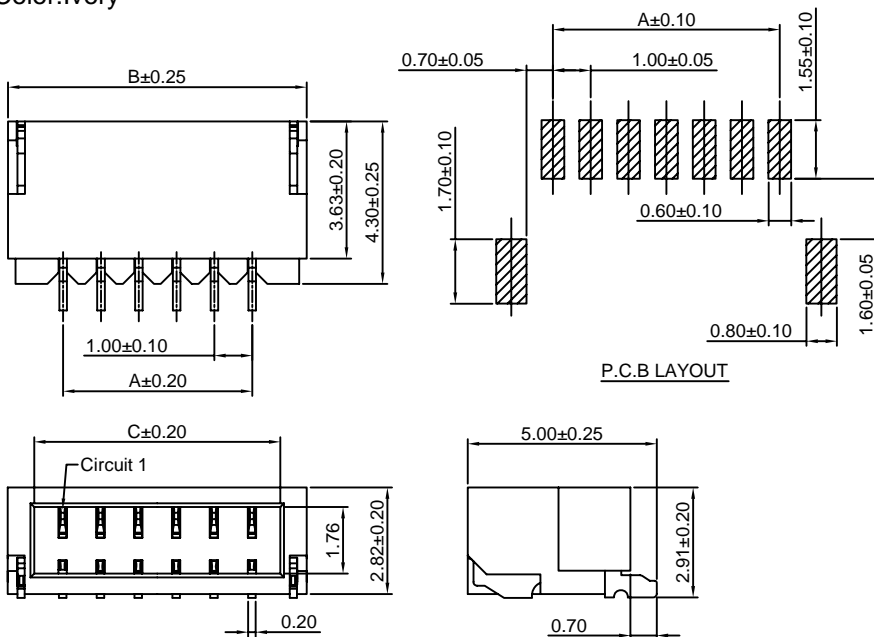

#### Ordering Information & Dimensions:

PART NO.	Dimensions		
	A	B	C
A1002WRD-2P	1.00	3.90	2.50
A1002WRD-3P	2.00	4.90	3.50
A1002WRD-4P	3.00	5.90	4.50
A1002WRD-5P	4.00	6.90	5.50
A1002WRD-6P	5.00	7.90	6.50
A1002WRD-7P	6.00	8.90	7.50
A1002WRD-8P	7.00	9.90	8.50
A1002WRD-9P	8.00	10.90	9.50
A1002WRD-10P	9.00	11.90	10.50
A1002WRD-11P	10.00	12.90	11.50
A1002WRD-12P	11.00	13.90	12.50
A1002WRD-13P	12.00	14.90	13.50
A1002WRD-14P	13.00	15.90	14.50
A1002WRD-15P	14.00	16.90	15.50
A1002WRD-16P	15.00	17.90	16.50
A1002WRD-17P	16.00	18.90	17.50
A1002WRD-18P	17.00	19.90	18.50
A1002WRD-19P	18.00	20.90	19.50
A1002WRD-20P	19.00	21.90	20.50

Unit:mm

## A1002H-2

1.00mm pitch Dual Row Housing

### Reference Informations:

- \*Material:PBT,UL94V-0
- \*Suitable CJT A1002 series Terminal
- \*Mates with CJT A1002 series Dual Row Wafer
- \*Color:White

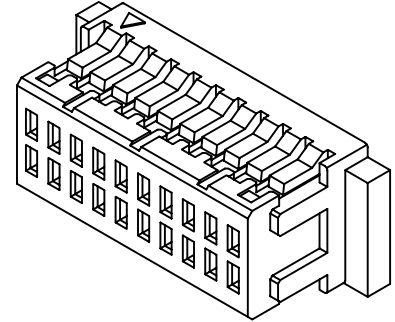
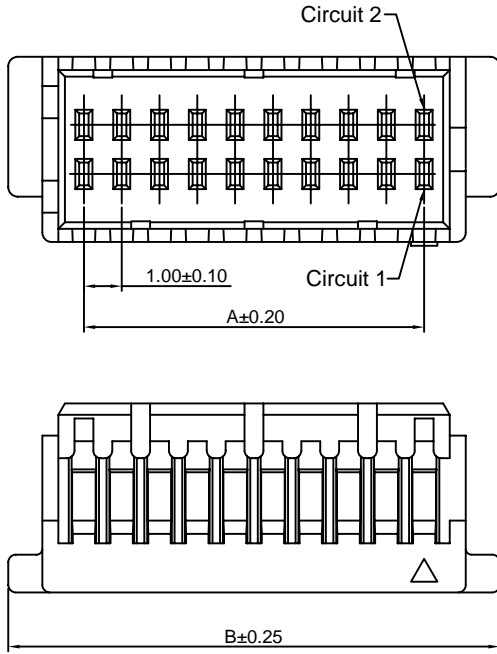

### Ordering Information & Dimensions:

PART NO.	Dimensions	
	A	B
A1002H-2x6P	5.00	9.00
A1002H-2x8P	7.00	11.00
A1002H-2x10P	9.00	13.00
A1002H-2x15P	14.00	18.00
A1002H-2x20P	19.00	23.00
A1002H-2x25P	24.00	28.00

Unit: mm

## A1002WV-S-2

1.00mm pitch 180° Dual Row Wafer - SMT TYPE

### Reference Informations:

- \*Material:Pin:Phosphor Bronze/Tin over Nickel  
Solder Tabs: Phosphor Bronze/Tin over Nickel  
Insulator:Nylon 6T,UL94V-0
- \*Mates with CJT A1002 series Dual Row Housing
- \*Color:Ivory

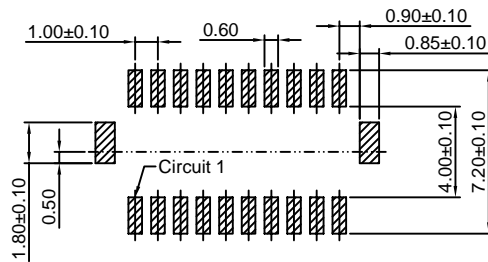
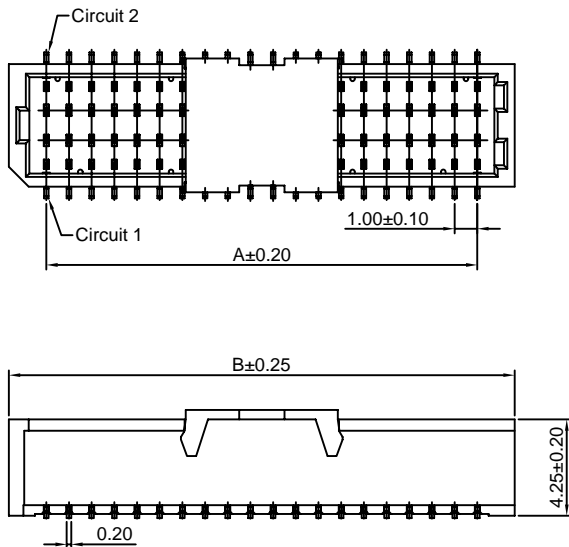

P.C.B LAYOUT

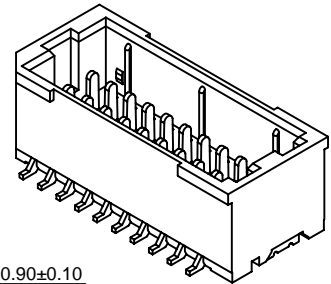

### Ordering Information & Dimensions:

PART NO.	Dimensions	
	A	B
A1002WV-S-2x6P	5.00	8.30
A1002WV-S-2x8P	7.00	10.30
A1002WV-S-2x10P	9.00	12.30
A1002WV-S-2x15P	14.00	17.30
A1002WV-S-2x20P	19.00	22.30
A1002WV-S-2x25P	24.00	27.30

Unit: mm

### A1002WV-S-F-2

1.00mm pitch 180° Dual Row Wafer - SMT TYPE

#### Reference Informations:

- \*Material: Pin: Phosphor Bronze/Tin over Nickel  
Solder Tabs: Phosphor Bronze/Tin over Nickel  
Insulator: Nylon 6T, UL94V-0
- \*Mates with CJT A1002 series Dual Row Housing
- \*Color: Ivory

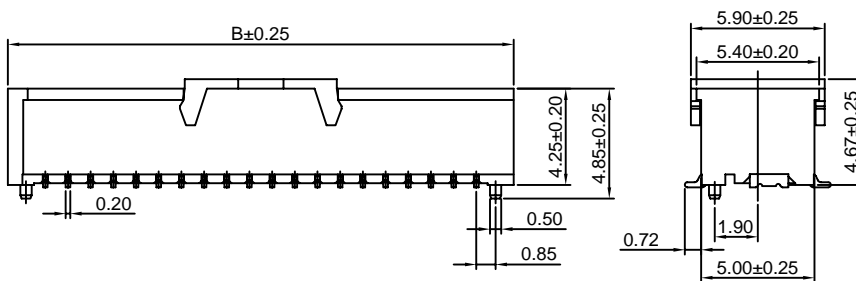
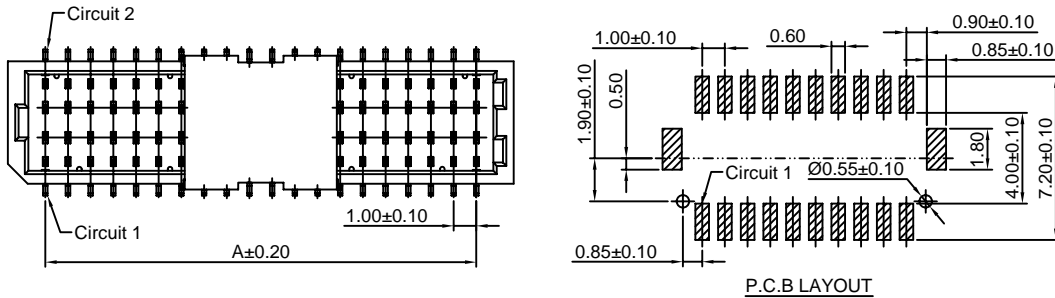
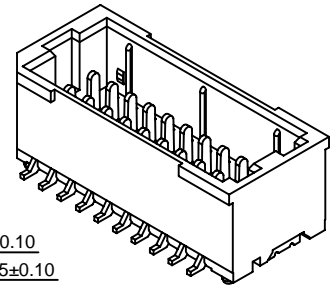

#### Ordering Information & Dimensions:

PART NO.	Dimensions	
	A	B
A1002WV-S-F-2x6P	5.00	8.30
A1002WV-S-F-2x8P	7.00	10.30
A1002WV-S-F-2x10P	9.00	12.30
A1002WV-S-F-2x15P	14.00	17.30
A1002WV-S-F-2x20P	19.00	22.30
A1002WV-S-F-2x25P	24.00	27.30

Unit: mm

### A1002WR-S-2

1.00mm pitch 90° Dual Row Wafer - SMT TYPE

#### Reference Informations:

- \*Material: Pin: Phosphor Bronze/Tin over Nickel  
Solder Tabs: Phosphor Bronze/Tin over Nickel  
Insulator: Nylon 6T, UL94V-0
- \*Mates with CJT A1002 series Dual Row Housing
- \*Color: Ivory

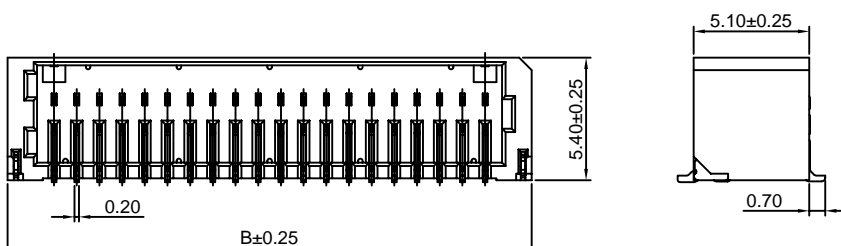
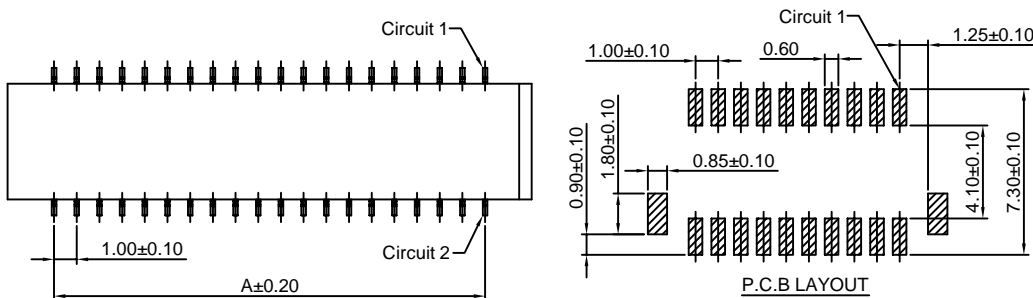
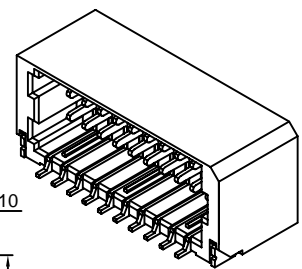

#### Ordering Information & Dimensions:

PART NO.	Dimensions	
	A	B
A1002WR-S-2x6P	5.00	8.30
A1002WR-S-2x8P	7.00	10.30
A1002WR-S-2x10P	9.00	12.30
A1002WR-S-2x15P	14.00	17.30
A1002WR-S-2x20P	19.00	22.30
A1002WR-S-2x25P	24.00	27.30

Unit: mm

## X-ON Electronics

Largest Supplier of Electrical and Electronic Components

*Click to view similar products for [Headers & Wire Housings](#) category:*

*Click to view products by [Changjiang](#) manufacturer:*

Other Similar products are found below :

[57102-F02-18ULF](#) [58102-G61-06LF](#) [0009485154](#) [009176003701906](#) [0050291907](#) [00-9021-0611-00-339](#) [02.125.8002.8](#) [609-3404](#) [61062-3](#)  
[622-0430](#) [622-3653LF](#) [63453-116](#) [636-1030](#) [636-1427](#) [636-3427](#) [636-4007](#) [641938-9](#) [644827-2](#) [65495-038](#) [65692-001LF](#) [65781-018](#)  
[65781-047](#) [65817-010LF](#) [65817-015LF](#) [66207-023LF](#) [67016-026LF](#) [67095-007LF](#) [68631-112](#) [68645-018](#) [68648-049](#) [699319-000](#)  
[70.362.1628.0](#) [70-4210](#) [70-4226B](#) [70-4853B](#) [707-5020](#) [707-5028](#) [71.350.2428.0](#) [71961-016LF](#) [733-134](#) [754199-000](#) [760-3052](#) [787-8014-00](#)  
[FCN-367T-T012/H](#) [80.063.4001.1](#) [800-90-001-10-001000](#) [800-90-010-10-002000](#) [801-43-002-10-013000](#) [801-43-006-10-002000](#)  
[803-41-018-10-001000](#)