

Specifications

- Current rating: 1A AC, DC
- Voltage rating: 125V AC, DC
- Temperature range: -40°C ~ +105°C
- Contact resistance: 20mΩ Max.
- Insulation resistance: 100MΩ Min.
- Withstanding voltage: 500V AC/minute
- *Compliant with RoHS and REACH*
- *Meet the HF/Halogen Free, need to customize*
- *Contact CJT for details*

Standards



Assembly layout

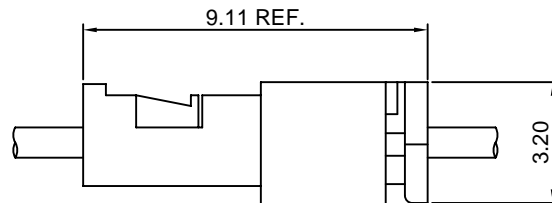

WIRE TO WIRE

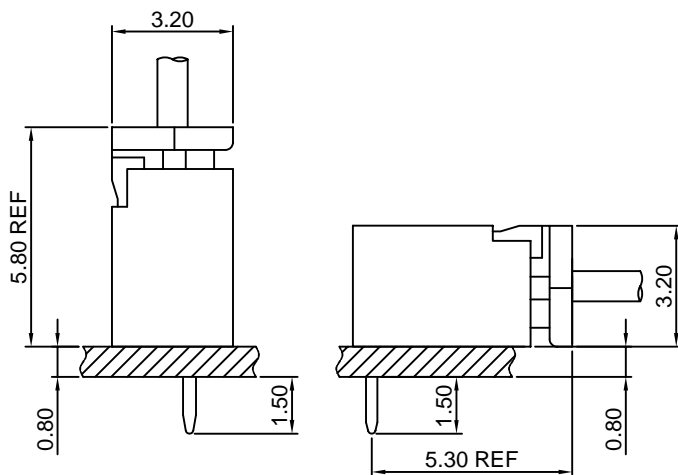

DIP YTYPE

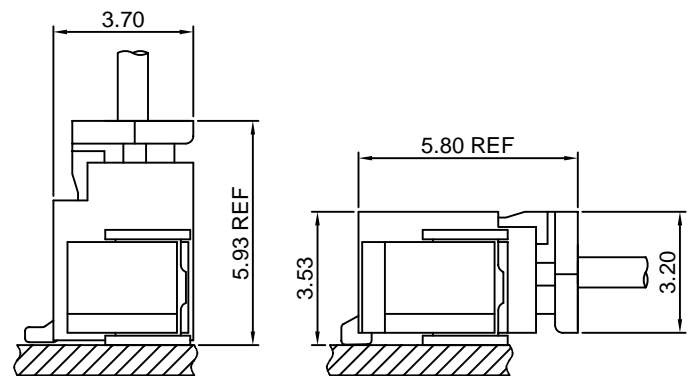

SMT YTYPE

A1251-T

1.25mm pitch Crimp Terminal

Reference Informations:

*Used in CJT A1251H-XP series Housing

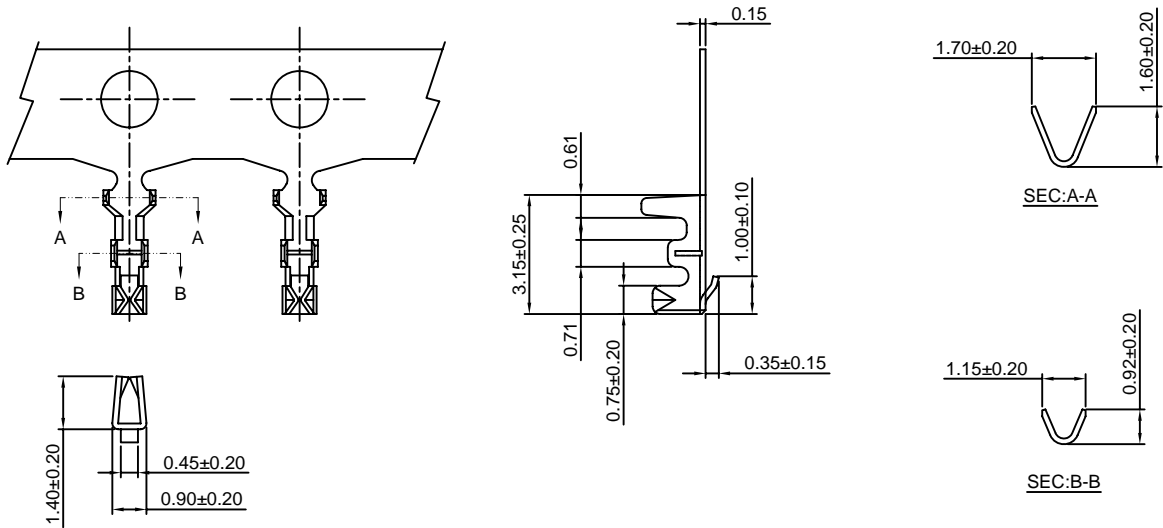

Ordering information & Specifications:

Unit:mm

Part NO.	Wire Range	Insulation O.D.	Material	Finish	Qty/reel
A1251-TP	AWG#28-#32	1.00mm(max)	Phosphor Bronze	Tin over Nickel	15,000 PCS
A1251-GP	AWG#28-#32	1.00mm(max)	Phosphor Bronze	Gold over Nickel	15,000 PCS

Optional Gold plating available but MOQ requested

A1251M-T

1.25mm pitch Crimp Terminal

Reference Informations:

*Used in CJT A1251HM-XP series Housing

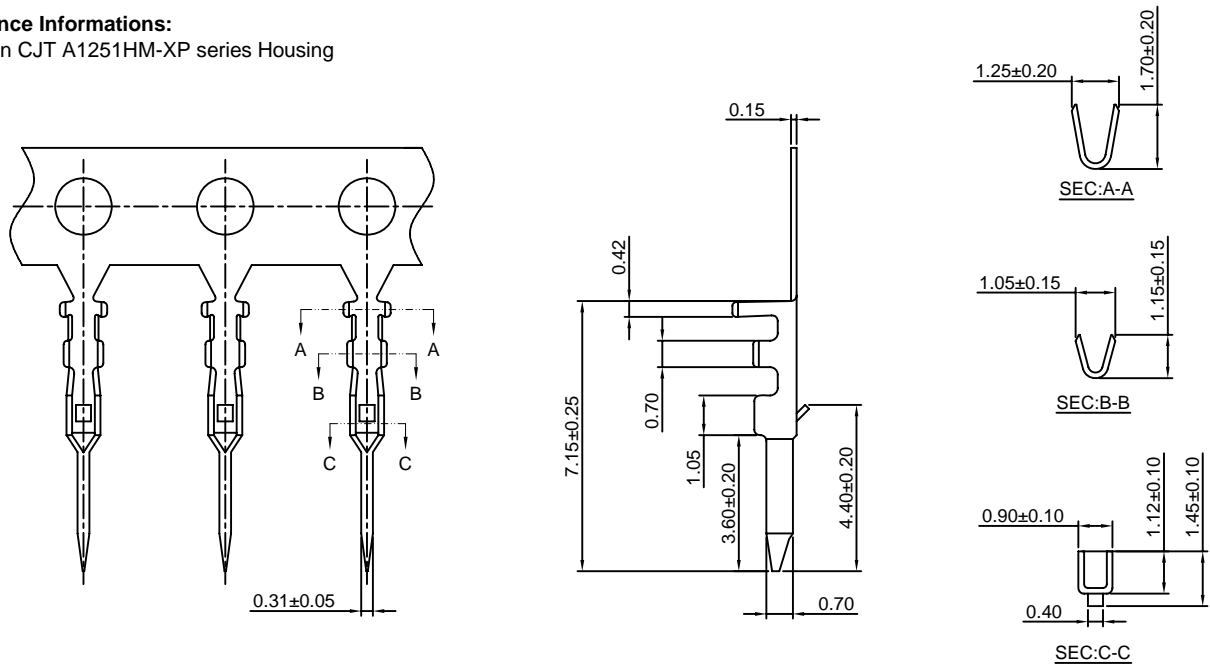

Ordering information & Specifications:

Unit:mm

Part NO.	Wire Range	Insulation O.D.	Material	Finish	Qty/reel
A1251M-TP	AWG#28-#32	1.00mm(max)	Phosphor Bronze	Tin over Nickel	15,000 PCS
A1251M-GP	AWG#28-#32	1.00mm(max)	Phosphor Bronze	Gold over Nickel	15,000 PCS

Optional Gold plating available but MOQ requested

A1251H-XP

1.25mm pitch Housing

Reference Informations:

- *Material:Nylon 66,UL94V-0
- *Suitable CJT A1251-T series Terminal
- *Mates with CJT A1251HM-XP,A1251WV,WR-XP, A1251WV-S,WR-S-XP series Wafer
- *Color:White

Ordering Information:

A1251H-XP - ***
1 2

- 1.Part No.
- 2.Material:
(Blank):Nylon 66,UL94V-0
GWT:Nylon 66,UL94V-0,GWT 750°C

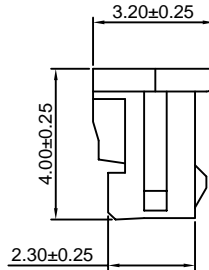
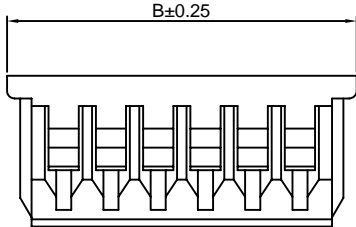
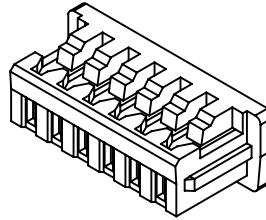
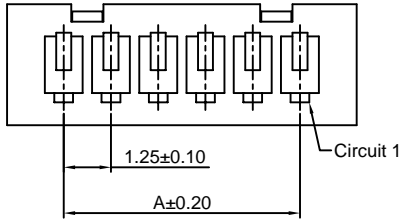

Ordering Information & Dimensions:

PART NO.	Dimensions	
	A	B
2P	1.25	4.25
3P	2.50	5.50
4P	3.75	6.75
5P	5.00	8.00
6P	6.25	9.25
7P	7.50	10.50
8P	8.75	11.75
9P	10.00	13.00
10P	11.25	14.25
11P	12.50	15.50
12P	13.75	16.75
13P	15.00	18.00
14P	16.25	19.25
15P	17.50	20.50
16P	18.75	21.75
17P	20.00	23.00
18P	21.25	24.25
19P	22.50	25.50
20P	23.75	26.75

Unit: mm

A1251HM-XP

1.25mm pitch Housing

Reference Informations:

- *Material:Nylon 66,UL94V-0
- *Suitable CJT A1251M-T series Terminal
- *Mates with CJT A1251H-XP series Housing
- *Color:White

Ordering Information:

A1251HM-XP - ***
1 2

- 1.Part No.
- 2.Material:
(Blank):Nylon 66,UL94V-0
GWT:Nylon 66,UL94V-0,GWT 750°C

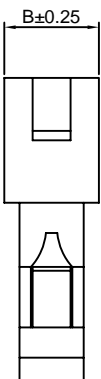
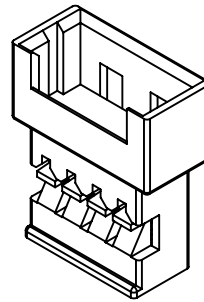
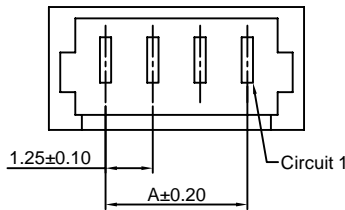
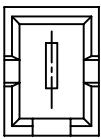

1P

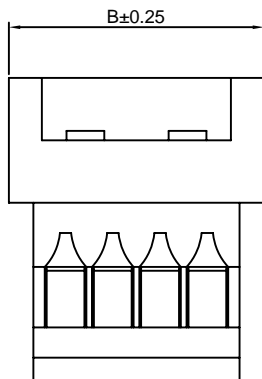
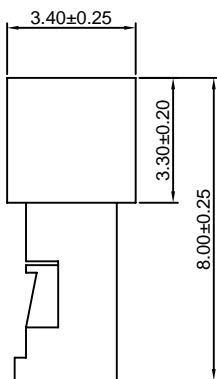

2P~20P

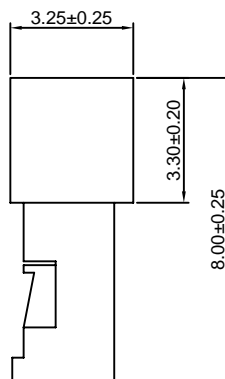

Ordering Information & Dimensions:

PART NO.	Dimensions	
	A	B
1P	----	2.50
2P	1.25	4.25
3P	2.50	5.50
4P	3.75	6.75
5P	5.00	8.00
6P	6.25	9.25
7P	7.50	10.50
8P	8.75	11.75
9P	10.00	13.00
10P	11.25	14.25
11P	12.50	15.50
12P	13.75	16.75
13P	15.00	18.00
14P	16.25	19.25
15P	17.50	20.50
16P	18.75	21.75
17P	20.00	23.00
18P	21.25	24.25
19P	22.50	25.50
20P	23.75	26.75

Unit: mm

A1251WV-XP

1.25mm pitch 180° Wafer

Reference Informations:

- *Material: Pin: Phosphor Bronze/Tin over Nickel
Insulator: Nylon 66, UL94V-0
- *Mates with CJT A1251H-XP series Housing
- *Color: Ivory

Ordering Information:

A1251WV-XP - *** - **
1 2 3

1. Part No.
2. Material:
(Blank): Nylon 66, UL94V-0
GWT: Nylon 66, UL94V-0, GWT 750 °C
3. Finish:
(Blank): Tin over Nickel
G: Gold over Nickel

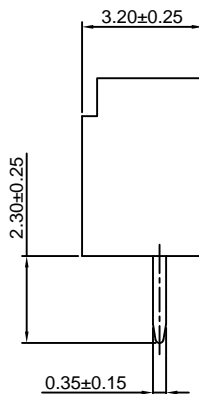
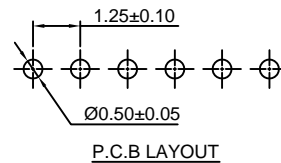
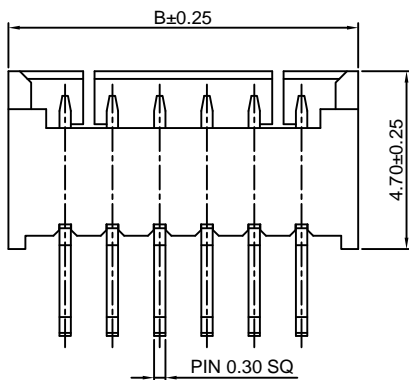
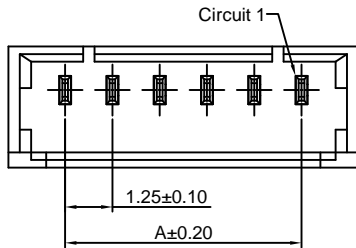
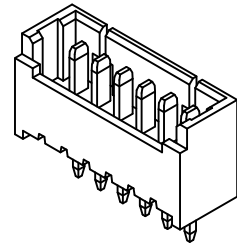

Ordering Information & Dimensions:

PART NO.	Dimensions	
	A	B
2P	1.25	4.30
3P	2.50	5.55
4P	3.75	6.80
5P	5.00	8.05
6P	6.25	9.30
7P	7.50	10.55
8P	8.75	11.80
9P	10.00	13.05
10P	11.25	14.30
11P	12.50	15.55
12P	13.75	16.80
13P	15.00	18.05
14P	16.25	19.30
15P	17.50	20.55
16P	18.75	21.80
17P	20.00	23.05
18P	21.25	24.30
19P	22.50	25.55
20P	23.75	26.80

Unit: mm

A1251WR-XP

1.25mm pitch 90° Wafer

Reference Informations:

- *Material: Pin: Phosphor Bronze/Tin over Nickel
Insulator: Nylon 66, UL94V-0
- *Mates with CJT A1251H-XP series Housing
- *Color: Ivory

Ordering Information:

A1251WR-XP - *** - **
1 2 3

1. Part No.
2. Material:
(Blank): Nylon 66, UL94V-0
GWT: Nylon 66, UL94V-0, GWT 750 °C
3. Finish:
(Blank): Tin over Nickel
G: Gold over Nickel

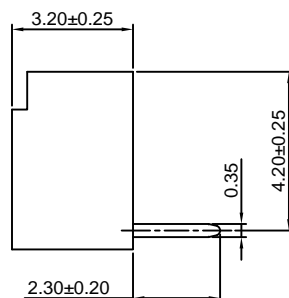
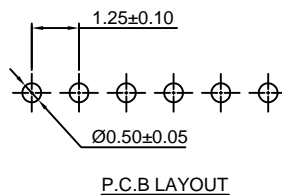
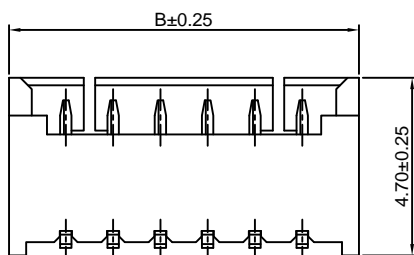
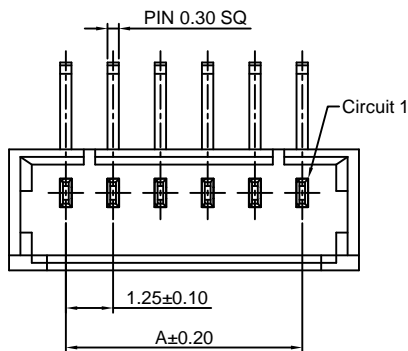
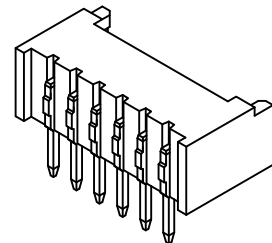

Ordering Information & Dimensions:

PART NO.	Dimensions	
	A	B
2P	1.25	4.30
3P	2.50	5.55
4P	3.75	6.80
5P	5.00	8.05
6P	6.25	9.30
7P	7.50	10.55
8P	8.75	11.80
9P	10.00	13.05
10P	11.25	14.30
11P	12.50	15.55
12P	13.75	16.80
13P	15.00	18.05
14P	16.25	19.30
15P	17.50	20.55
16P	18.75	21.80
17P	20.00	23.05
18P	21.25	24.30
19P	22.50	25.55
20P	23.75	26.80

Unit: mm

A1251WV-S-XP

1.25mm pitch 180° Wafer-SMT TYPE

Reference Informations:

- *Material: Pin: Phosphor Bronze/Tin over Nickel
Solder Tabs: Phosphor Bronze/Tin over Nickel
Insulator: Nylon 6T, UL94V-0
- *Mates with CJT A1251H-XP series Housing
- *Color: Ivory

- Ordering Information:**
A1251WV-S-XP - *** - **
 1 2 3
 1. Part No.
 2. Material:
 (Blank): Nylon 6T, UL94V-0
 GWT: Nylon 6T, UL94V-0, GWT 750 °C
 3. Finish:
 (Blank): Tin over Nickel
 G: Gold over Nickel

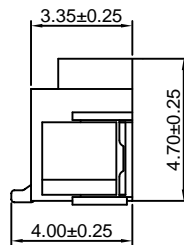
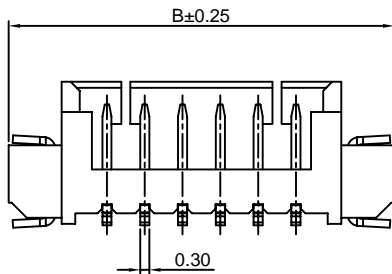
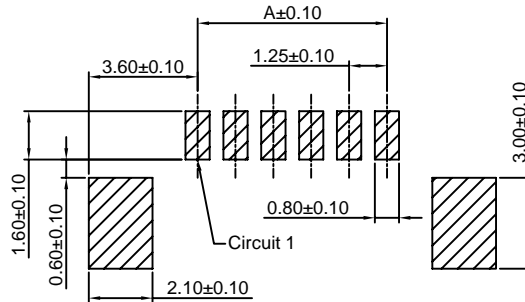
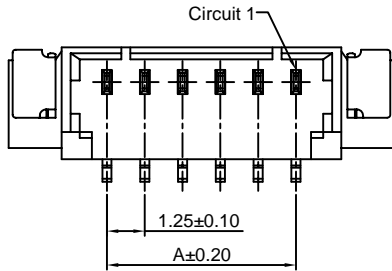
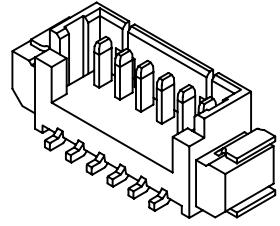

Ordering Information & Dimensions:

PART NO.	Dimensions	
	A	B
2P	1.25	7.75
3P	2.50	9.00
4P	3.75	10.25
5P	5.00	11.50
6P	6.25	12.75
7P	7.50	14.00
8P	8.75	15.25
9P	10.00	16.50
10P	11.25	17.75
11P	12.50	19.00
12P	13.75	20.25
13P	15.00	21.50
14P	16.25	22.75
15P	17.50	24.00
16P	18.75	25.25
17P	20.00	26.50
18P	21.25	27.75
19P	22.50	29.00
20P	23.75	30.25

Unit: mm

A1251WR-S-XP

1.25mm pitch 90° Wafer-SMT TYPE

Reference Informations:

- *Material: Pin: Phosphor Bronze/Tin over Nickel
Solder Tabs: Phosphor Bronze/Tin over Nickel
Insulator: Nylon 6T, UL94V-0
- *Mates with CJT A1251H-XP series Housing
- *Color: Ivory

- Ordering Information:**
A1251WR-S-XP - *** - **
 1 2 3
 1. Part No.
 2. Material:
 (Blank): Nylon 6T, UL94V-0
 GWT: Nylon 6T, UL94V-0, GWT 750 °C
 3. Finish:
 (Blank): Tin over Nickel
 G: Gold over Nickel

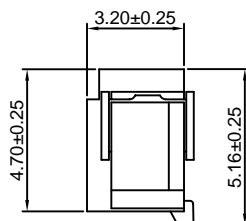
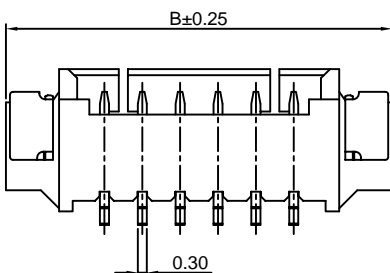
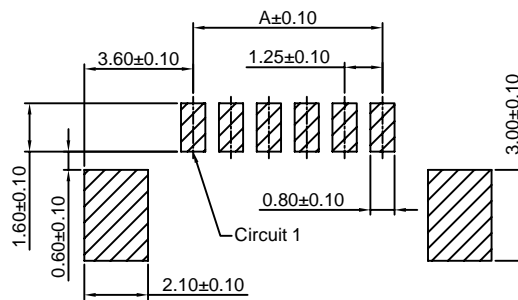
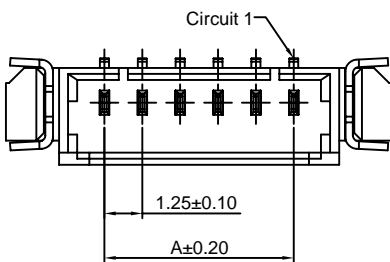
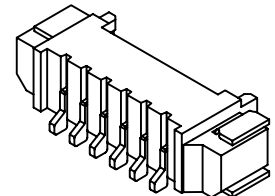

Ordering Information & Dimensions:

PART NO.	Dimensions	
	A	B
2P	1.25	7.75
3P	2.50	9.00
4P	3.75	10.25
5P	5.00	11.50
6P	6.25	12.75
7P	7.50	14.00
8P	8.75	15.25
9P	10.00	16.50
10P	11.25	17.75
11P	12.50	19.00
12P	13.75	20.25
13P	15.00	21.50
14P	16.25	22.75
15P	17.50	24.00
16P	18.75	25.25
17P	20.00	26.50
18P	21.25	27.75
19P	22.50	29.00
20P	23.75	30.25

Unit: mm

A1251WRA-S-XP

1.25mm pitch 90° Wafer-SMT TYPE

Reference Informations:

- *Material:Pin:Phosphor Bronze/Tin over Nickel
Solder Tabs:Phosphor Bronze/Tin over Nickel
Insulator:Nylon 9T,UL94V-0
- *Mates with CJT A1251H-XP series Housing
- *Color:Natural

Ordering Information:

A1251WRA-S-XP - *** - **
1 2 3

- 1.Part No.
- 2.Material:
(Blank):Nylon 9T,UL94V-0
GWT:Nylon 9T,UL94V-0,GWT 750°C
- 3.Finish:
(blank):Tin over Nickel
G:Gold over Nickel

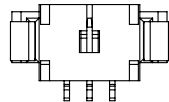
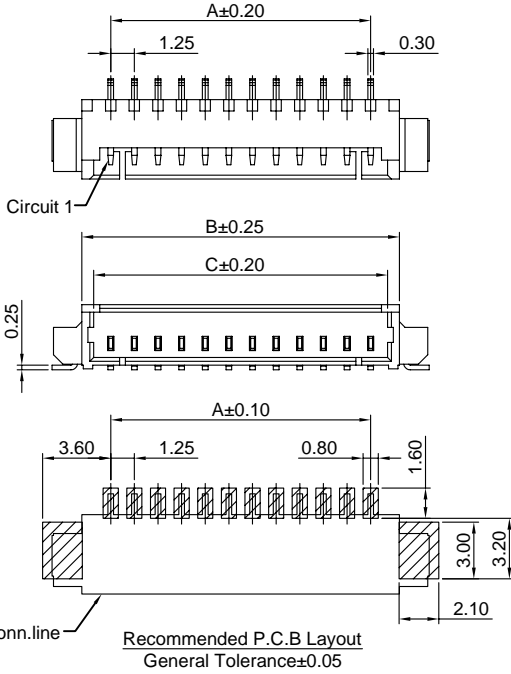
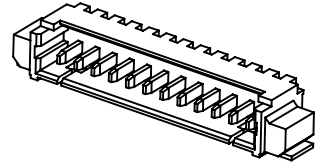

02P~03P Single Hole

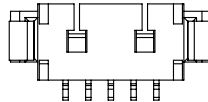
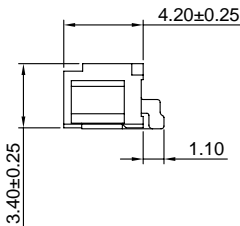

04P~20P Double Hole

Ordering Information & Dimensions:

PART NO.	Dimensions	
	A	B
2P	1.25	7.75
3P	2.50	9.00
4P	3.75	10.25
5P	5.00	11.50
6P	6.25	12.75
7P	7.50	14.00
8P	8.75	15.25
9P	10.00	16.50
10P	11.25	17.75
11P	12.50	19.00
12P	13.75	20.25
13P	15.00	21.50
14P	16.25	22.75
15P	17.50	24.00
16P	18.75	25.25
17P	20.00	26.50
18P	21.25	27.75
19P	22.50	29.00
20P	23.75	30.25

Unit: mm

X-ON Electronics

Largest Supplier of Electrical and Electronic Components

Click to view similar products for [Headers & Wire Housings](#) category:

Click to view products by [Changjiang](#) manufacturer:

Other Similar products are found below :

[57102-F02-18ULF](#) [58102-G61-06LF](#) [0009485154](#) [009176003701906](#) [0050291907](#) [02.125.8002.8](#) [609-3404](#) [61062-3](#) [622-0430](#) [622-3653LF](#)
[63453-116](#) [636-1030](#) [636-1427](#) [636-3427](#) [636-4007](#) [641938-9](#) [644827-2](#) [65495-038](#) [65692-001LF](#) [65781-018](#) [65781-047](#) [65817-010LF](#)
[65817-015LF](#) [66207-023LF](#) [67016-026LF](#) [67095-007LF](#) [68631-112](#) [68645-018](#) [68648-049](#) [699319-000](#) [70.362.1628.0](#) [70-4210](#) [70-4226B](#)
[70-4853B](#) [707-5020](#) [707-5028](#) [71.350.2428.0](#) [71961-016LF](#) [733-134](#) [754199-000](#) [760-3052](#) [787-8014-00](#) [FCN-367T-T012/H](#) [80.063.4001.1](#)
[800-90-001-10-001000](#) [800-90-010-10-002000](#) [801-43-002-10-013000](#) [801-43-006-10-002000](#) [803-41-018-10-001000](#) [803-43-014-20-](#)
[001000](#)