

## Specifications

- Current rating: 1A AC, DC
- Voltage rating: 150V AC, DC
- Temperature range: -40°C ~ +105°C
- Contact resistance: 30mΩ Max.
- Insulation resistance: 500MΩ Min.
- Withstanding voltage: 500V AC/minute
- \*Compliant with RoHS and REACH\*
- \*Meet the HF/Halogen Free, need to customize\*
- \*Contact CJT for details\*

## Standards

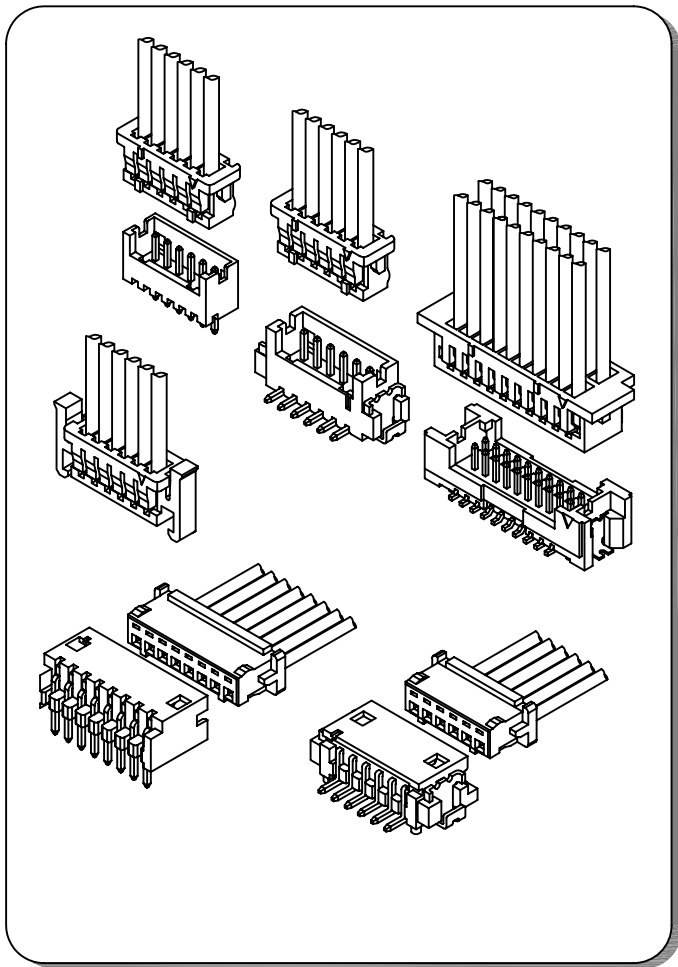

## Assembly layout

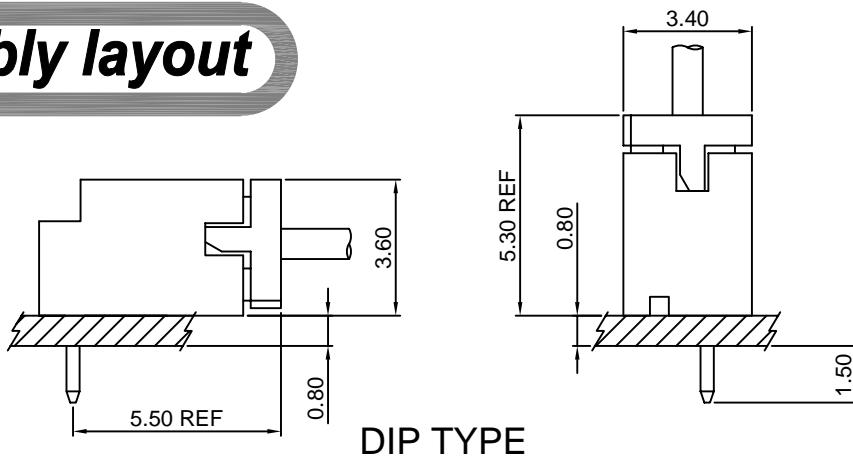

DIP TYPE

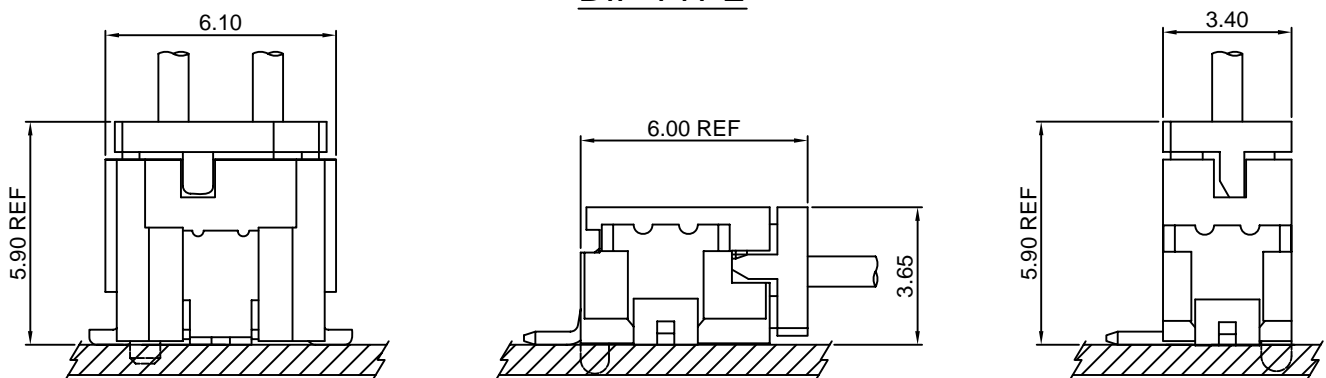

SMT TYPE

## A1252-T

1.25mm pitch Crimp Terminal

### Reference Informations:

\*Used in CJT A1252 series Housing

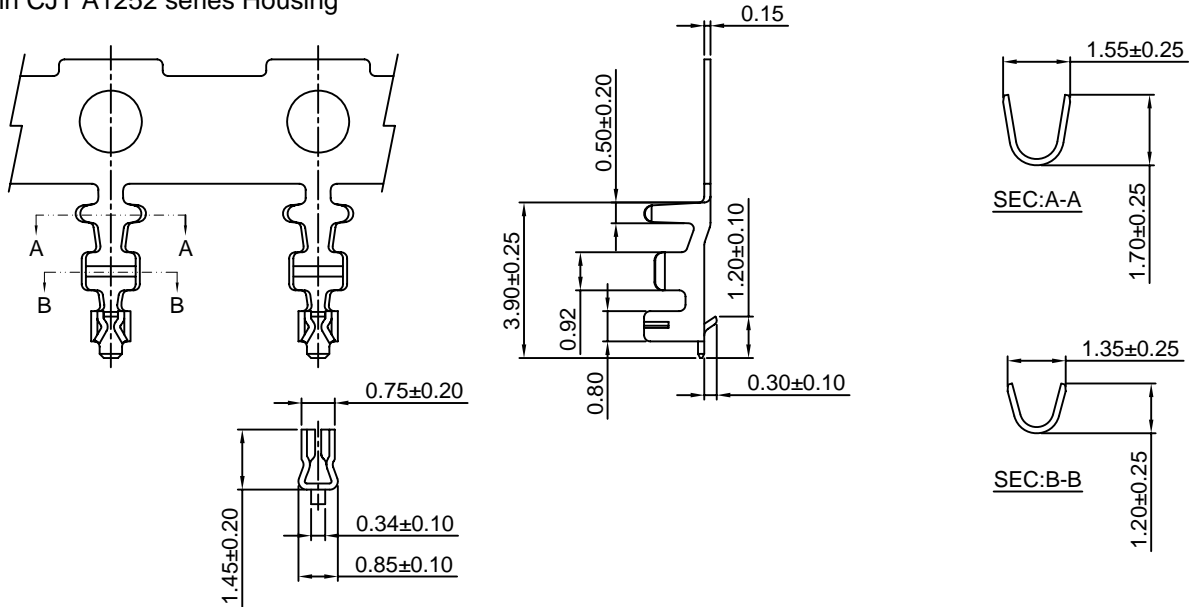

Ordering information & Specifications:

Unit:mm

Part NO.	Wire Range	Insulation O.D.	Material	Finish	Qty/reel
A1252-TP	AWG#26-#30	1.00mm(max)	Phosphor Bronze	Tin over Nickel	10,000 PCS
A1252-GP	AWG#26-#30	1.00mm(max)	Phosphor Bronze	Gold over Nickel	10,000 PCS

Optional Gold plating available but MOQ requested

## A1252H

1.25mm pitch Single Row Housing

### Reference Informations:

\*Material:Nylon 66,UL94V-0

\*Suitable CJT A1252 series Terminal

\*Mates with CJT A1252 series Single Row Wafer

\*Color:Gray

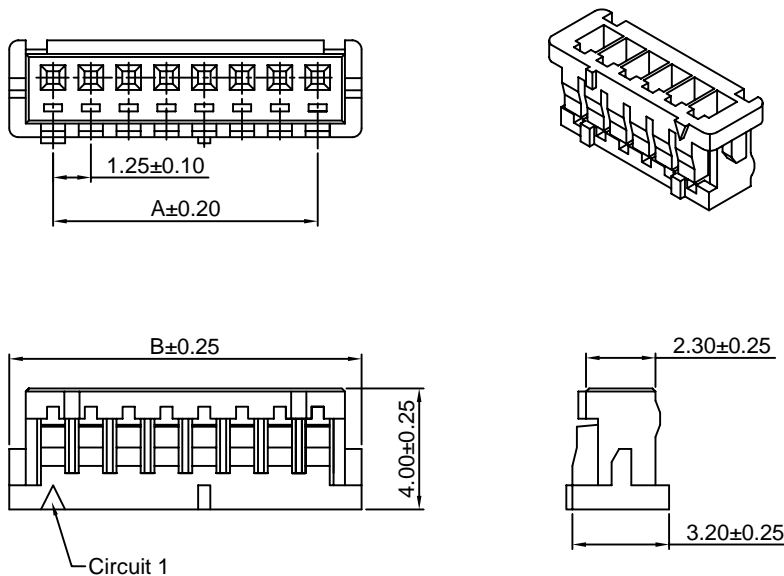

Ordering Information & Dimensions:

PART NO.	Dimensions	
	A	B
A1252H-2P	1.25	4.15
A1252H-3P	2.50	5.40
A1252H-4P	3.75	6.65
A1252H-5P	5.00	7.90
A1252H-6P	6.25	9.15
A1252H-7P	7.50	10.40
A1252H-8P	8.75	11.65
A1252H-9P	10.00	12.90
A1252H-10P	11.25	14.15
A1252H-11P	12.50	15.40
A1252H-12P	13.75	16.65
A1252H-13P	15.00	17.90
A1252H-14P	16.25	19.15
A1252H-15P	17.50	20.40

Unit: mm

## A1252HA

1.25mm pitch Single Row Housing

### Reference Informations:

- \*Material:Nylon 66,UL94V-0
- \*Suitable CJT A1252 series Terminal
- \*Color:White

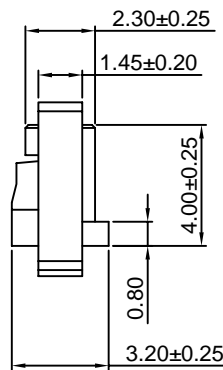
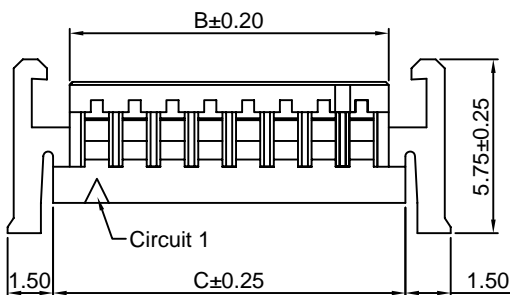
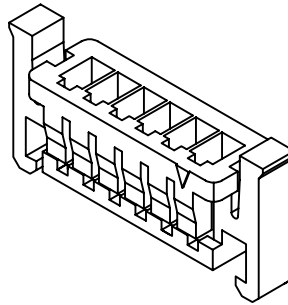
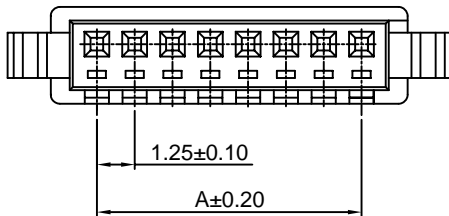

Ordering Information & Dimensions:

PART NO.	Dimensions		
	A	B	C
A1252HA-2P	1.25	2.90	4.15
A1252HA-3P	2.50	4.15	5.40
A1252HA-4P	3.75	5.40	6.65
A1252HA-5P	5.00	6.65	7.90
A1252HA-6P	6.25	7.90	9.15
A1252HA-7P	7.50	9.15	10.40
A1252HA-8P	8.75	10.40	11.65
A1252HA-9P	10.00	11.65	12.90
A1252HA-10P	11.25	12.90	14.15
A1252HA-11P	12.50	14.15	15.40
A1252HA-12P	13.75	15.40	16.65
A1252HA-13P	15.00	16.65	17.90
A1252HA-14P	16.25	17.90	19.15
A1252HA-15P	17.50	19.15	20.40

Unit: mm

## A1252H-2

1.25mm pitch Dual Row Housing

### Reference Informations:

- \*Material:Nylon 66,UL94V-0
- \*Suitable CJT A1252 series Terminal
- \*Mates with CJT A1252WV-S,A1252WV-S-F series Dual Row Wafer
- \*Color:Gray

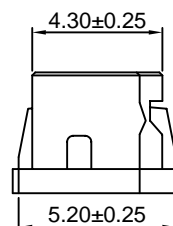
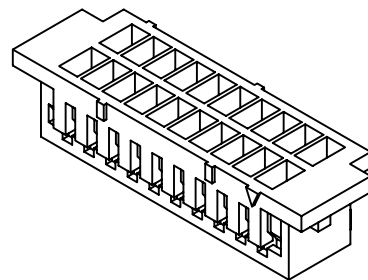
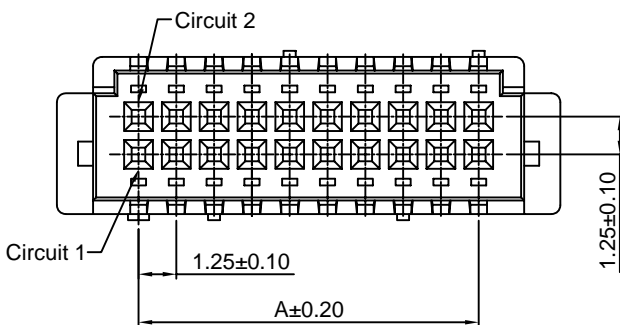

Ordering Information & Dimensions:

PART NO.	Dimensions	
	A	B
A1252H-2x5P	5.00	10.40
A1252H-2x7P	7.50	12.90
A1252H-2x10P	11.25	16.65
A1252H-2x15P	17.50	22.90
A1252H-2x20P	23.75	29.15

Unit: mm

## A1252WV

1.25mm pitch 180° Single Row Wafer

### Reference Informations:

- \*Material: Pin: Brass/Tin over Nickel  
Insulator: Nylon 66, UL94V-0
- \*Mates with CJT A1252 series Single Row Housing
- \*Color: Gray

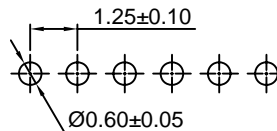
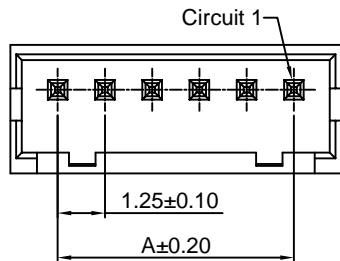
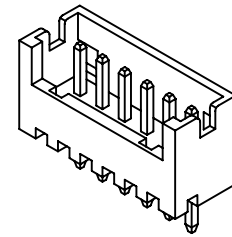

P.C.B LAYOUT

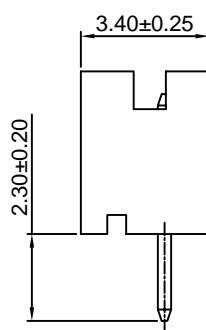
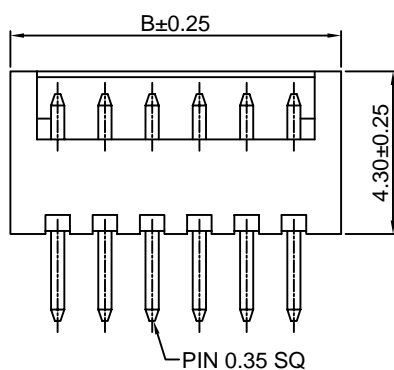

### Ordering Information & Dimensions:

PART NO.	Dimensions	
	A	B
A1252WV-2P	1.25	3.75
A1252WV-3P	2.50	5.00
A1252WV-4P	3.75	6.25
A1252WV-5P	5.00	7.50
A1252WV-6P	6.25	8.75
A1252WV-7P	7.50	10.00
A1252WV-8P	8.75	11.25
A1252WV-9P	10.00	12.50
A1252WV-10P	11.25	13.75
A1252WV-11P	12.50	15.00
A1252WV-12P	13.75	16.25
A1252WV-13P	15.00	17.50
A1252WV-14P	16.25	18.75
A1252WV-15P	17.50	20.00

Unit: mm

## A1252WV-S

1.25mm pitch 180° Single Row Wafer-SMT TYPE

### Reference Informations:

- \*Material: Pin: Brass/Tin over Nickel  
Insulator: Nylon 6T, UL94V-0  
Cap: Nylon 6T, UL94V-0
- \*Mates with CJT A1252 series Single Row Housing
- \*Color: Ivory

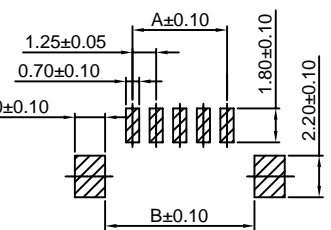
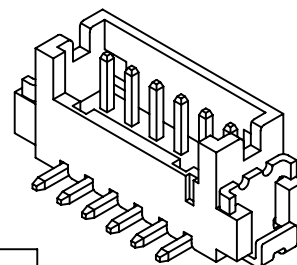

P.C.B LAYOUT

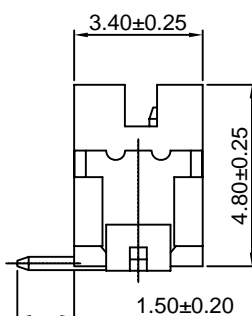
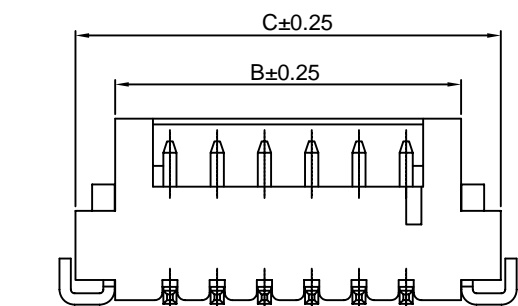
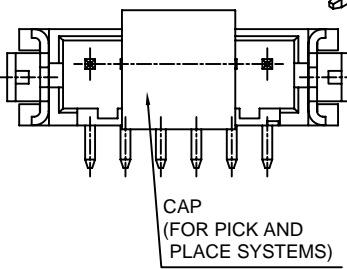
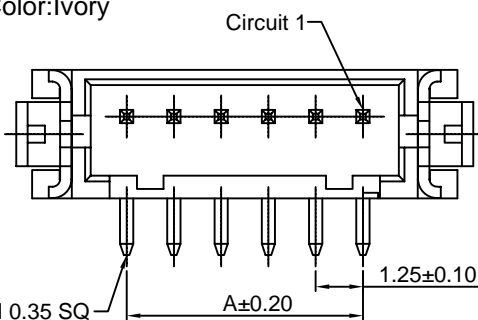

### Ordering Information & Dimensions:

PART NO.	Dimensions		
	A	B	C
A1252WV-S-2P	1.25	4.15	6.25
A1252WV-S-3P	2.50	5.40	7.50
A1252WV-S-4P	3.75	6.65	8.75
A1252WV-S-5P	5.00	7.90	10.00
A1252WV-S-6P	6.25	9.15	11.25
A1252WV-S-7P	7.50	10.40	12.50
A1252WV-S-8P	8.75	11.65	13.75
A1252WV-S-9P	10.00	12.90	15.00
A1252WV-S-10P	11.25	14.15	16.25
A1252WV-S-11P	12.50	15.40	17.50
A1252WV-S-12P	13.75	16.65	18.75
A1252WV-S-13P	15.00	17.90	20.00
A1252WV-S-14P	16.25	19.15	21.25
A1252WV-S-15P	17.50	20.40	22.50

Unit: mm

### A1252WV-S-F

1.25mm pitch 180° Single Row Wafer-SMT TYPE

#### Reference Informations:

- \*Material: Pin: Brass/Tin over Nickel  
Solder Tabs: Phosphor Bronze/Tin over Nickel  
Insulator: Nylon 6T, UL94V-0  
Cap: Nylon 6T, UL94V-0
- \*Mates with CJT A1252 series Single Row Housing
- \*Color: Ivory

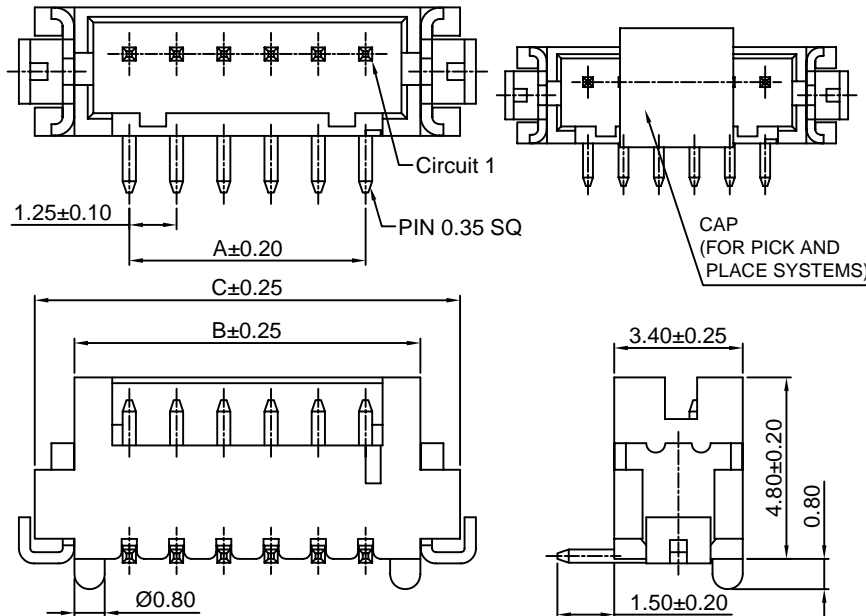
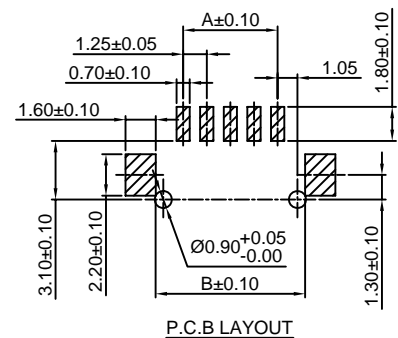
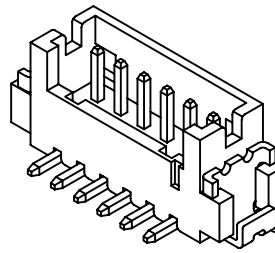

#### Ordering Information & Dimensions:

PART NO.	Dimensions		
	A	B	C
A1252WV-S-F-2P	1.25	4.15	6.25
A1252WV-S-F-3P	2.50	5.40	7.50
A1252WV-S-F-4P	3.75	6.65	8.75
A1252WV-S-F-5P	5.00	7.90	10.00
A1252WV-S-F-6P	6.25	9.15	11.25
A1252WV-S-F-7P	7.50	10.40	12.50
A1252WV-S-F-8P	8.75	11.65	13.75
A1252WV-S-F-9P	10.00	12.90	15.00
A1252WV-S-F-10P	11.25	14.15	16.25
A1252WV-S-F-11P	12.50	15.40	17.50
A1252WV-S-F-12P	13.75	16.65	18.75
A1252WV-S-F-13P	15.00	17.90	20.00
A1252WV-S-F-14P	16.25	19.15	21.25
A1252WV-S-F-15P	17.50	20.40	22.50

Unit: mm

### A1252WR

1.25mm pitch 90° Single Row Wafer

#### Reference Informations:

- \*Material: Pin: Brass/Tin over Nickel  
Insulator: Nylon 66, UL94V-0
- \*Mates with CJT A1252 series Single Row Housing
- \*Color: Gray

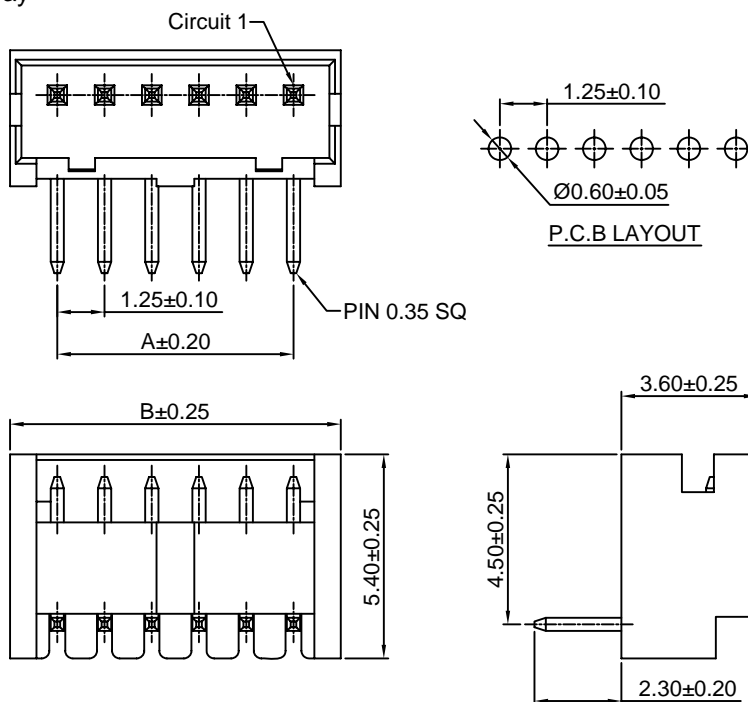
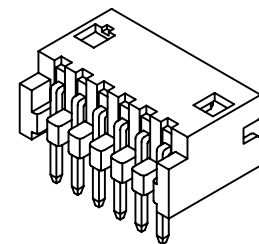

#### Ordering Information & Dimensions:

PART NO.	Dimensions	
	A	B
A1252WR-2P	1.25	3.75
A1252WR-3P	2.50	5.00
A1252WR-4P	3.75	6.25
A1252WR-5P	5.00	7.50
A1252WR-6P	6.25	8.75
A1252WR-7P	7.50	10.00
A1252WR-8P	8.75	11.25
A1252WR-9P	10.00	12.50
A1252WR-10P	11.25	13.75
A1252WR-11P	12.50	15.00
A1252WR-12P	13.75	16.25
A1252WR-13P	15.00	17.50
A1252WR-14P	16.25	18.75
A1252WR-15P	17.50	20.00

Unit: mm

## A1252WR-S

1.25mm pitch 90° Single Row Wafer-SMT TYPE

### Reference Informations:

- \*Material: Pin: Brass/Tin over Nickel  
Solder Tabs: Phosphor Bronze/Tin over Nickel  
Insulator: Nylon 6T, UL94V-0
- \*Mates with CJT A1252 series Single Row Housing
- \*Color: Ivory

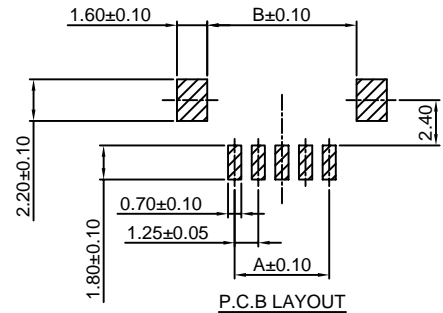
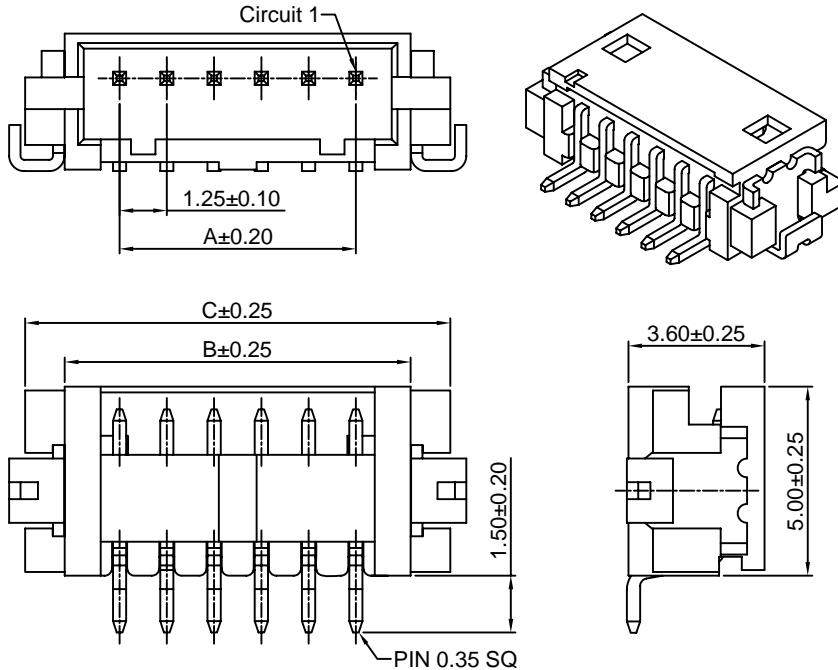

### Ordering Information & Dimensions:

PART NO.	Dimensions		
	A	B	C
A1252WR-S-2P	1.25	4.15	6.25
A1252WR-S-3P	2.50	5.40	7.50
A1252WR-S-4P	3.75	6.65	8.75
A1252WR-S-5P	5.00	7.90	10.00
A1252WR-S-6P	6.25	9.15	11.25
A1252WR-S-7P	7.50	10.40	12.50
A1252WR-S-8P	8.75	11.65	13.75
A1252WR-S-9P	10.00	12.90	15.00
A1252WR-S-10P	11.25	14.15	16.25
A1252WR-S-11P	12.50	15.40	17.50
A1252WR-S-12P	13.75	16.65	18.75
A1252WR-S-13P	15.00	17.90	20.00
A1252WR-S-14P	16.25	19.15	21.25
A1252WR-S-15P	17.50	20.40	22.50

Unit: mm

## A1252WR-S-F

1.25mm pitch 90° Single Row Wafer-SMT TYPE

### Reference Informations:

- \*Material: Pin: Brass/Tin over Nickel  
Solder Tabs: Phosphor Bronze/Tin over Nickel  
Insulator: Nylon 6T, UL94V-0
- \*Mates with CJT A1252 series Single Row Housing
- \*Color: Ivory

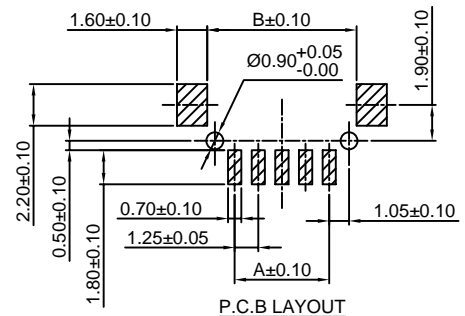
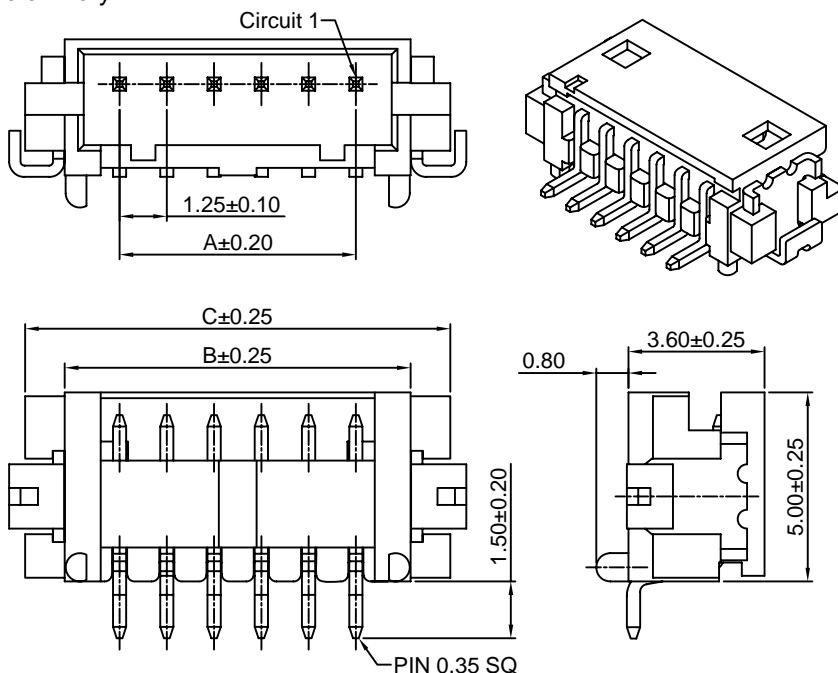

### Ordering Information & Dimensions:

PART NO.	Dimensions		
	A	B	C
A1252WR-S-F-2P	1.25	4.15	6.25
A1252WR-S-F-3P	2.50	5.40	7.50
A1252WR-S-F-4P	3.75	6.65	8.75
A1252WR-S-F-5P	5.00	7.90	10.00
A1252WR-S-F-6P	6.25	9.15	11.25
A1252WR-S-F-7P	7.50	10.40	12.50
A1252WR-S-F-8P	8.75	11.65	13.75
A1252WR-S-F-9P	10.00	12.90	15.00
A1252WR-S-F-10P	11.25	14.15	16.25
A1252WR-S-F-11P	12.50	15.40	17.50
A1252WR-S-F-12P	13.75	16.65	18.75
A1252WR-S-F-13P	15.00	17.90	20.00
A1252WR-S-F-14P	16.25	19.15	21.25
A1252WR-S-F-15P	17.50	20.40	22.50

Unit: mm

## A1252WV-S-2

1.25mm pitch 180° Dual Row Wafer-SMT TYPE

### Reference Informations:

- \*Material: Pin: Brass/Tin over Nickel  
Solder Tabs: Phosphor Bronze/Tin over Nickel  
Insulator: Nylon 6T, UL94V-0  
Cap: Nylon 6T, UL94V-0
- \*Mates with CJT A1252 series Dual Row Housing
- \*Color: Ivory

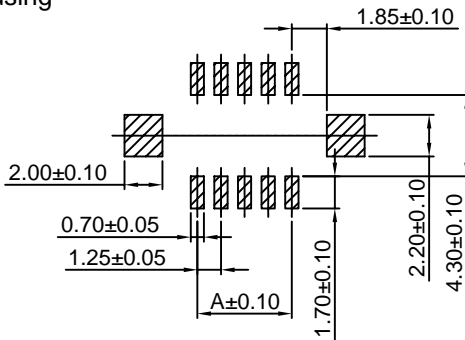
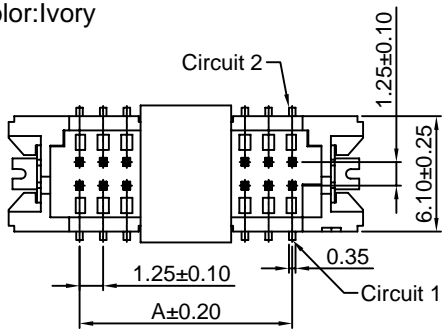
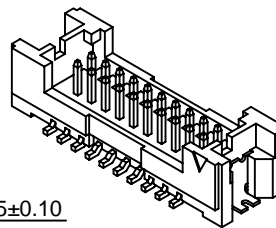

P.C.B LAYOUT

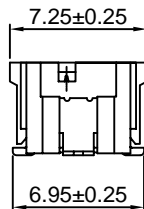
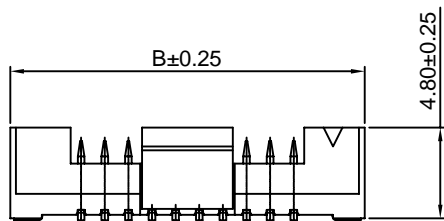

Ordering Information & Dimensions:

PART NO.	Dimensions	
	A	B
A1252WV-S-2x5P	5.00	12.50
A1252WV-S-2x7P	7.50	15.00
A1252WV-S-2x10P	11.25	18.75
A1252WV-S-2x15P	17.50	25.00
A1252WV-S-2x20P	23.75	31.25

Unit: mm

## A1252WV-S-F-2

1.25mm pitch 180° Dual Row Wafer-SMT TYPE

### Reference Informations:

- \*Material: Pin: Brass/Tin over Nickel  
Solder Tabs: Phosphor Bronze/Tin over Nickel  
Insulator: Nylon 6T, UL94V-0  
Cap: Nylon 6T, UL94V-0
- \*Mates with CJT A1252 series Dual Row Housing
- \*Color: Ivory

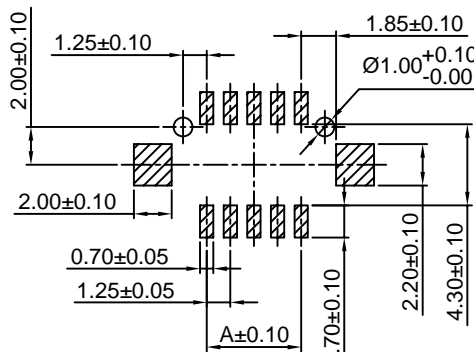
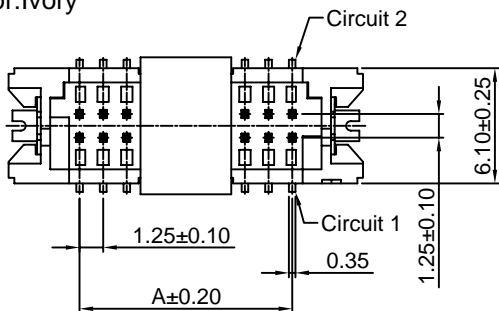
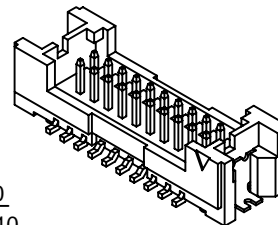

P.C.B LAYOUT

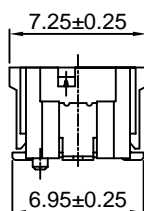
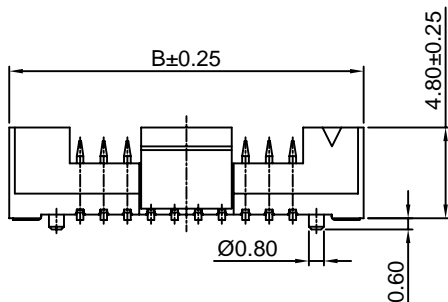

Ordering Information & Dimensions:

PART NO.	Dimensions	
	A	B
A1252WV-S-F-2x5P	5.00	12.50
A1252WV-S-F-2x7P	7.50	15.00
A1252WV-S-F-2x10P	11.25	18.75
A1252WV-S-F-2x15P	17.50	25.00
A1252WV-S-F-2x20P	23.75	31.25

Unit: mm

## X-ON Electronics

Largest Supplier of Electrical and Electronic Components

*Click to view similar products for [Headers & Wire Housings](#) category:*

*Click to view products by [Changjiang](#) manufacturer:*

Other Similar products are found below :

[57102-F02-18ULF](#) [58102-G61-06LF](#) [0009485154](#) [009176003701906](#) [0050291907](#) [00-9021-0611-00-339](#) [02.125.8002.8](#) [609-3404](#) [61062-3](#)  
[622-0430](#) [622-3653LF](#) [63453-116](#) [636-1030](#) [636-1427](#) [636-3427](#) [636-4007](#) [641938-9](#) [644827-2](#) [65495-038](#) [65692-001LF](#) [65781-018](#)  
[65781-047](#) [65817-010LF](#) [65817-015LF](#) [66207-023LF](#) [67016-026LF](#) [67095-007LF](#) [68631-112](#) [68645-018](#) [68648-049](#) [699319-000](#)  
[70.362.1628.0](#) [70-4210](#) [70-4226B](#) [70-4853B](#) [707-5020](#) [707-5028](#) [71.350.2428.0](#) [71961-016LF](#) [733-134](#) [754199-000](#) [760-3052](#) [787-8014-00](#)  
[FCN-367T-T012/H](#) [80.063.4001.1](#) [800-90-001-10-001000](#) [800-90-010-10-002000](#) [801-43-002-10-013000](#) [801-43-006-10-002000](#)  
[803-41-018-10-001000](#)