

Specifications

- Current rating:1A AC,DC
- Voltage rating:125V AC,DC
- Temperature range:-40°C~+105°C
- Contact resistance:20mΩMax.
- Insulation resistance:100MΩMin.
- Withstanding voltage:500V AC/minute
- *Compliant with RoHS and REACH*
- *Meet the HF/Halogen Free,need to customize*
- *Contact CJT for details*

Standards



Assembly layout

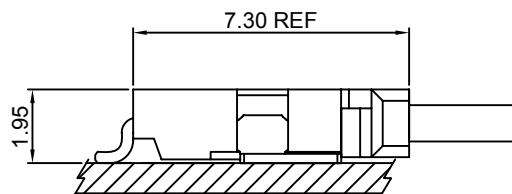

A1254-T

1.25mm pitch Crimp Terminal

Reference Informations:

*Used in CJT A1254H-XP series Housing

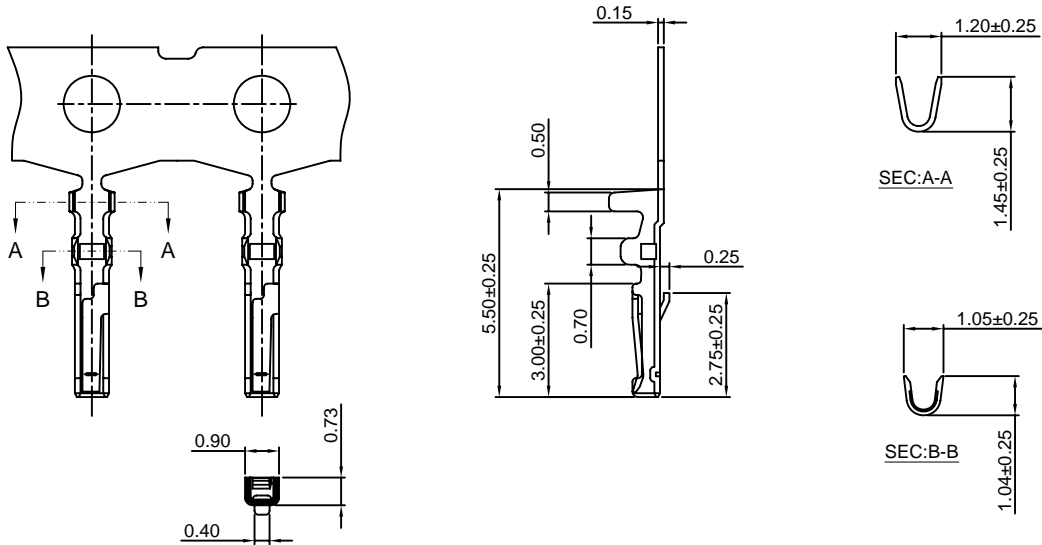

Ordering information & Specifications:

Unit:mm

Part NO.	Wire Range	Insulation O.D.	Material	Finish	Qty/reel
A1254-TP	AWG#28-#32	0.90mm(max)	Phosphor Bronze	Tin over Nickel	10,000 PCS
A1254-GP	AWG#28-#32	0.90mm(max)	Phosphor Bronze	Gold over Nickel	10,000 PCS

Optional Gold plating available but MOQ requested

A1254H-XP

1.25mm pitch Housing

Reference Informations:

*Material:Nylon 66,UL94V-0

*Suitable CJT A1254-T series Terminal

*Mates with CJT A1254WR-S-XP series Wafer

*Color:White

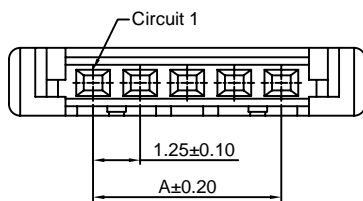

Ordering Information:

A1254H-XP - ***
1 2

1.Part No.

2.Material:

(Blank):Nylon 66,UL94V-0

GWT :Nylon 66,UL94V-0 GWT 750°C

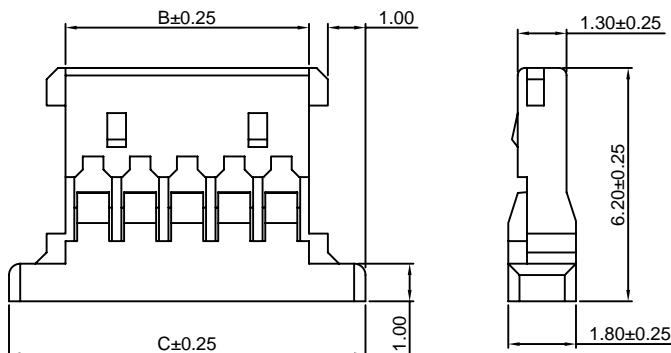
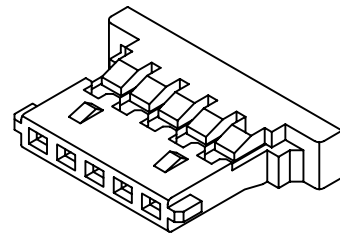

Ordering Information & Dimensions:

PART NO.	Dimensions			PART NO.	Dimensions		
	A	B	C		A	B	C
2P	1.25	2.72	5.72	17P	20.00	21.47	24.47
3P	2.50	3.97	6.97	18P	21.25	22.72	25.72
4P	3.75	5.22	8.22	19P	22.50	23.97	26.97
5P	5.00	6.47	9.47	20P	23.75	25.22	28.22
6P	6.25	7.72	10.72	21P	25.00	26.47	29.47
7P	7.50	8.97	11.97	22P	26.25	27.72	30.72
8P	8.75	10.22	13.22	23P	27.50	28.97	31.97
9P	10.00	11.47	14.47	24P	28.75	30.22	33.22
10P	11.25	12.72	15.72	25P	30.00	31.47	34.47
11P	12.50	13.97	16.97	26P	31.25	32.72	35.72
12P	13.75	15.22	18.22	27P	32.50	33.97	36.97
13P	15.00	16.47	19.47	28P	33.75	35.22	38.22
14P	16.25	17.72	20.72	29P	35.00	36.47	39.47
15P	17.50	18.97	21.97	30P	36.25	37.72	40.72
16P	18.75	20.22	23.22				

Unit: mm

A1254HA-XP

1.25mm pitch Housing

Reference Informations:

- *Material:Nylon 66,UL94V-0
- *Suitable CJT A1254-T series Terminal
- *Color:White

Ordering Information:

- A1254HA-XP - ***
 1 2
 1.Part No.
 2.Material:
 (Blank):Nylon 66,UL94V-0
 GWT :Nylon 66,UL94V-0 GWT 750 °C

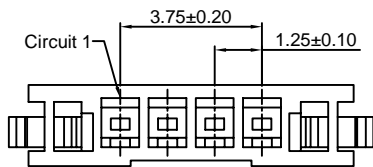
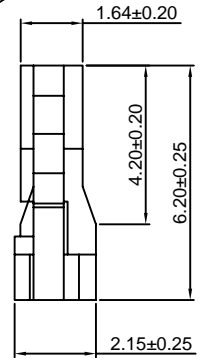
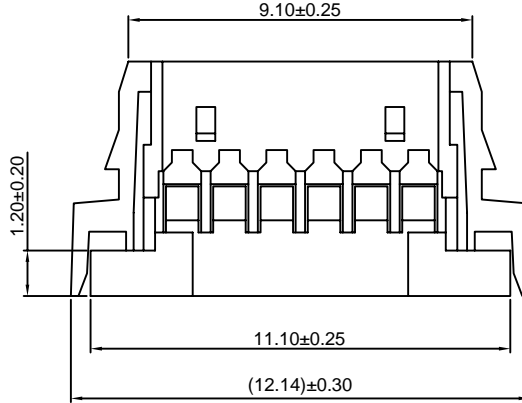
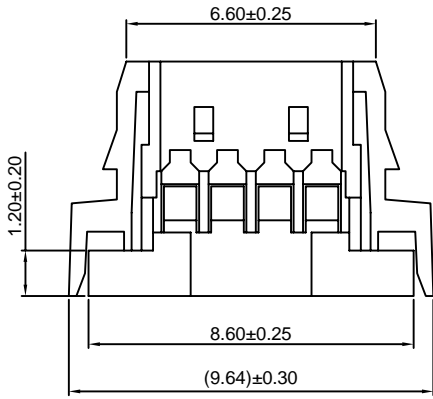
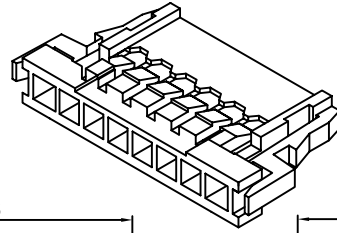

A1254HA-4P

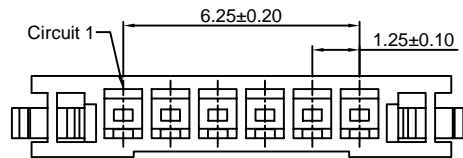

A1254HA-6P

Unit: mm

A1254WR-S-XP

1.25mm pitch 90° Wafer-SMT TYPE

Reference Informations:

- *Material:Pin:Brass/Tin over Nickel on solder area
Gold over Nickel on contact area
Solder Tabs:Brass/Tin over Nickel
Insulator:Nylon 6T,UL94V-0
- *Mates with CJT A1254H-XP series Housing
- *Color:Beige

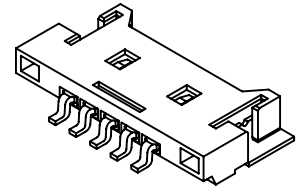
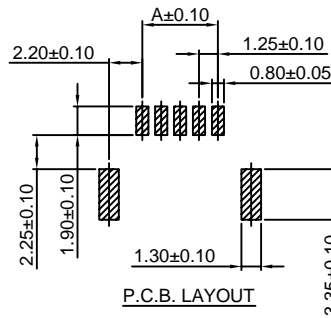

Ordering Information:

- A1254WR-S-XP - ***
 1 2
 1.Part No.
 2.Material:
 (Blank):Nylon 6T,UL94V-0
 GWT :Nylon 6T,UL94V-0 GWT 750 °C

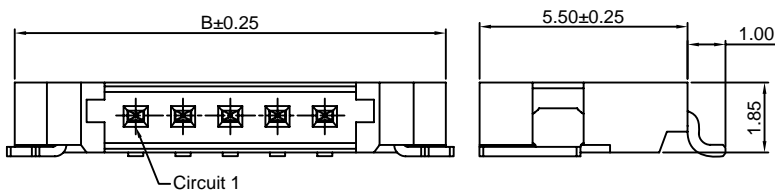
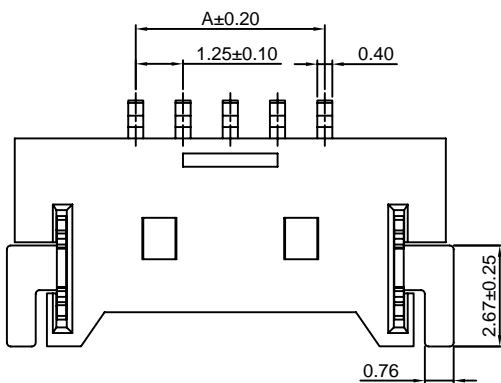

Ordering Information & Dimensions:

PART NO.	Dimensions		PART NO.	Dimensions	
	A	B		A	B
2P	1.25	7.65	17P	20.00	26.40
3P	2.50	8.90	18P	21.25	27.65
4P	3.75	10.15	19P	22.50	28.90
5P	5.00	11.40	20P	23.75	30.15
6P	6.25	12.65	21P	25.00	31.40
7P	7.50	13.90	22P	26.25	32.65
8P	8.75	15.15	23P	27.50	33.90
9P	10.00	16.40	24P	28.75	35.15
10P	11.25	17.65	25P	30.00	36.40
11P	12.50	18.90	26P	31.25	37.65
12P	13.75	20.15	27P	32.50	38.90
13P	15.00	21.40	28P	33.75	40.15
14P	16.25	22.65	29P	35.00	41.40
15P	17.50	23.90	30P	36.25	42.65
16P	18.75	25.15			

Unit: mm

X-ON Electronics

Largest Supplier of Electrical and Electronic Components

Click to view similar products for [Terminals](#) category:

Click to view products by [Changjiang](#) manufacturer:

Other Similar products are found below :

[00-054007-01074-6](#) [00-054007-70206-1](#) [00-054007-70210-8](#) [00-054007-70217-7](#) [00-054007-70228-3](#) [00-054007-70256-6](#) [00-054007-70316-7](#) [00-054007-49560-4](#) [00-054007-70209-2](#) [00-054007-70231-3](#) [00-054007-70241-2](#) [00-054007-70242-9](#) [00-054007-70246-7](#) [00-054007-70263-4](#) [00-054007-70288-7](#) [00-054007-70290-0](#) [00-054007-70300-6](#) [00-054007-70304-4](#) [01-2900-1-04412](#) [00581P0075](#) [600TS-10](#) [604200-1](#) [605601-1](#) [60598-1-CUT-TAPE](#) [60617-1-C](#) [61314-6-C](#) [61810-3](#) [62149-1](#) [626-0194](#) [62-NBM-A](#) [62-SP](#) [63-S](#) [M55155/059I03](#)
[M55155/079C01](#) [M55155/099B03](#) [M55155/099H02](#) [M55155/109H01](#) [M55155/12XH05](#) [M55155/16XH02](#) [M55155/29-5S](#) [M55155/29XJ08](#)
[M55155/30-6S](#) [M55155/30-9S](#) [M55155/30XI09](#) [696683-1](#) [696861-1](#) [696999-1](#) [M86700006](#) [D18-110B-C](#) [D18-110B-M](#)