

Specifications

- Current rating:1A AC,DC
- Voltage rating:50V AC,DC
- Temperature range:-40°C~+105°C
- Contact resistance:30mΩMax.
- Insulation resistance:100MΩMin.
- Withstanding voltage:500V AC/minute
- *Compliant with RoHS and REACH*
- *Meet the HF/Halogen Free,need to customize*
- *Contact CJT for details*

Standards



Assembly layout

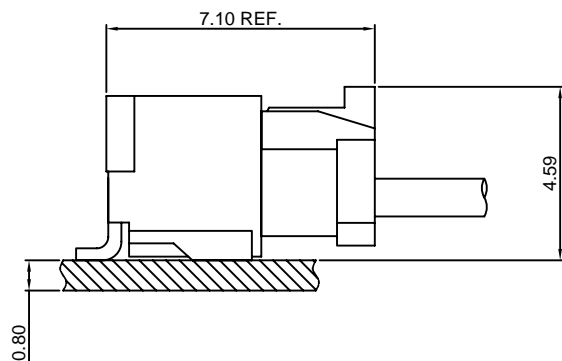
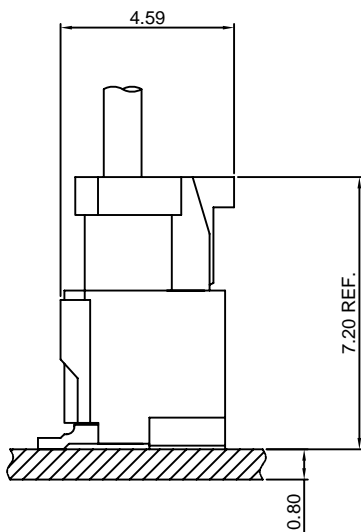



A1257 SERIES

1.25mm pitch wire to board connector

A1257-T

1.25mm pitch Crimp Terminal

Reference Informations:

*Used in CJT A1257H-XP,A1257HA-XP series Housing

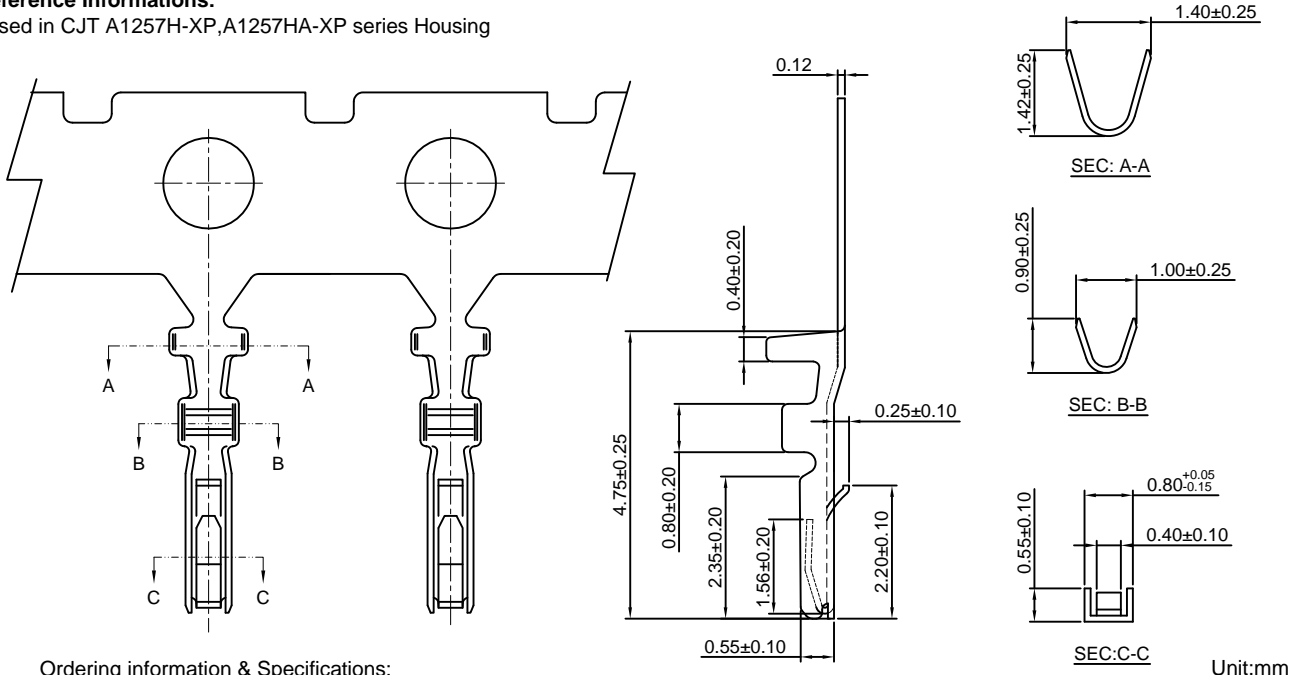

Ordering information & Specifications:

Part NO	Wire Range	Insulation O.D.	Material	Finish	Qty/reel
A1257-TP	AWG#28-#32	1.00mm(max)	Phosphor Bronze	Tin over Nickel	20,000 PCS
A1257-GP	AWG#28-#32	1.00mm(max)	Phosphor Bronze	Gold over Nickel	20,000 PCS

Optional Gold plating available but MOQ requested

A1257H-XP

1.25mm pitch Housing

Reference Informations:

- *Material:Nylon 66,UL94V-0
- *Suitable CJT A1257-T series Terminal
- *Mates with CJT A1257WV-S,WR-S-XP series Wafer
- *Color:White

Ordering Information:
A1257H-XP - *** - ***
1 2 3

- Part No.
- Material:
(Blank):Nylon 66,UL94V-0
GWT:Nylon 66,UL94V-0,GWT 750 °C
- Color:
(Blank):White
BK:Black BL:Blue
OR:Orange LE:Light blue
TR:Tomato red LY:Lemon yellow
MG:Moss green DPK:Dark pink

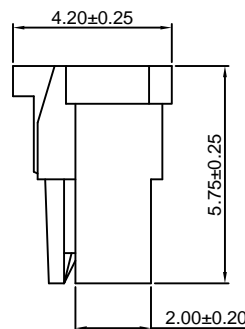
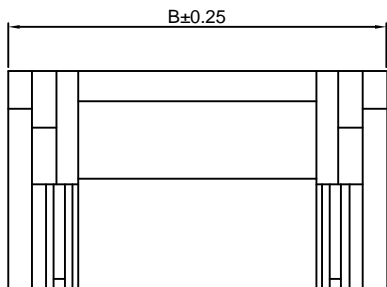
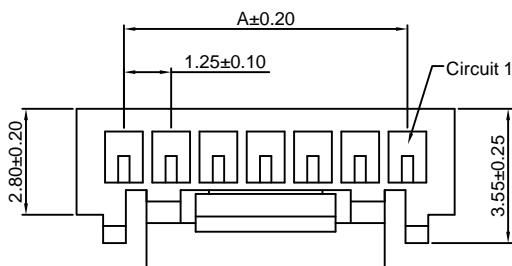
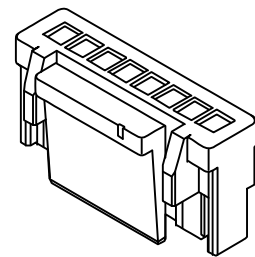

Ordering Information & Dimensions:

PART NO.	Dimensions	
	A	B
2P	1.25	3.75
3P	2.50	5.00
4P	3.75	6.25
5P	5.00	7.50
6P	6.25	8.75
7P	7.50	10.00
8P	8.75	11.25
9P	10.00	12.50
10P	11.25	13.75
11P	12.50	15.00
12P	13.75	16.25
13P	15.00	17.50
14P	16.25	18.75
15P	17.50	20.00

Unit: mm



A1257 SERIES

1.25mm pitch wire to board connector

A1257HA-XP

1.25mm pitch Housing

Reference Informations:

- *Material:PBT,UL94V-0
- *Suitable CJT A1257-T series Terminal
- *Color:White

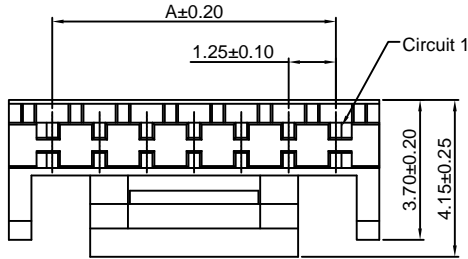

Ordering Information:
A1257HA-XP - ***
 1 2
 1.Part No.
 2.Material:
 (Blank):PBT,UL94V-0
 GWT:PBT,UL94V-0,GWT 750°C

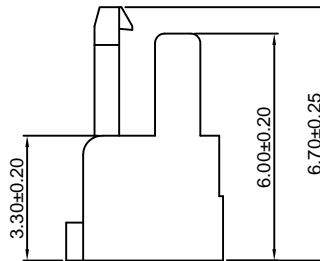
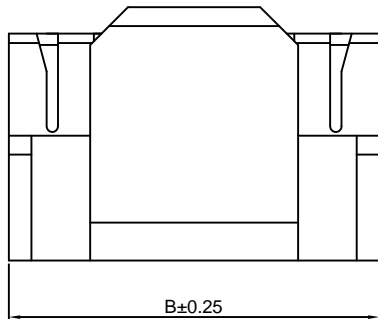
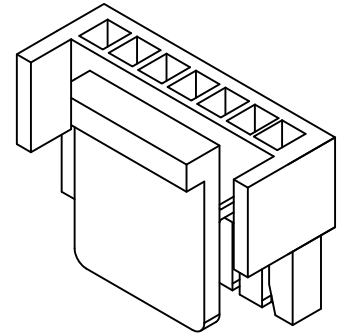

Ordering Information & Dimensions:

PART NO.	Dimensions	
	A	B
4P	3.75	6.05
5P	5.00	7.30
7P	7.50	9.80
8P	8.75	11.05
10P	11.25	13.56

Unit: mm

A1257WV-S-XP

1.25mm pitch 180° Wafer-SMT TYPE

Reference Informations:

- *Material:Pin:Brass/Tin over Nickel
Insulator:Nylon 9T,UL94V-0
- *Mates with CJT A1257H-XP series Housing
- *Color:Ivory

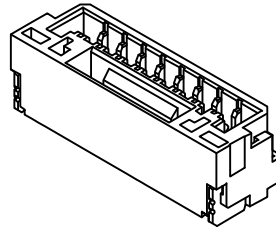

Ordering Information:
A1257WV-S-XP - *** - *** - *
 1 2 3 4
 1.Part No.
 2.Material:
 (Blank):Nylon 9T,UL94V-0
 GWT:Nylon 9T,UL94V-0,GWT 750°C
 3.Color:
 (Blank):Ivory
 BK:Black BL:Blue
 OR:Orange LE:Light blue
 TR:Tomato red LY:Lemon yellow
 MG:Moss green DPK:Dark pink
 4.Finish:
 (Blank):Tin over Nickel
 G:Gold over Nickel

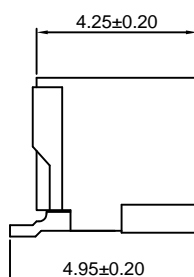
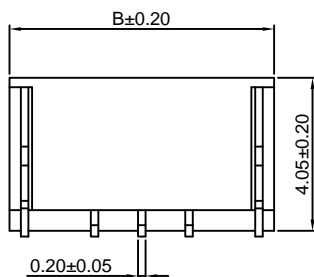
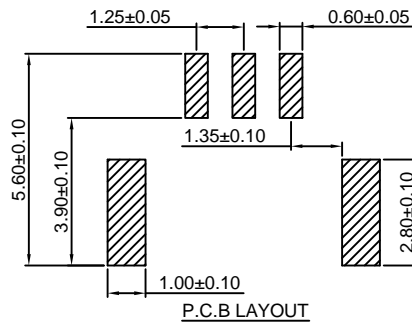
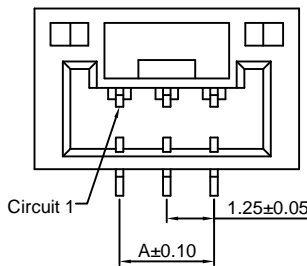

Ordering Information & Dimensions:

PART NO.	Dimensions	
	A	B
2P	1.25	5.75
3P	2.50	7.00
4P	3.75	8.25
5P	5.00	9.50
6P	6.25	10.75
7P	7.50	12.00
8P	8.75	13.25
9P	10.00	14.50
10P	11.25	15.75
11P	12.50	17.00
12P	13.75	18.25
13P	15.00	19.50
14P	16.25	20.75
15P	17.50	22.00

Unit: mm



A1257 SERIES

1.25mm pitch wire to board connector

A1257WR-S-XP

1.25mm pitch 90° Wafer-SMT TYPE

Reference Informations:

- *Material:Pin:Brass/Tin over Nickel
Insulator:Nylon 9T,UL94V-0
- *Mates with CJT A1257H-XP series Housing
- *Color:Ivory

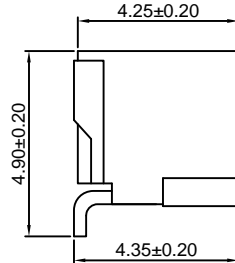
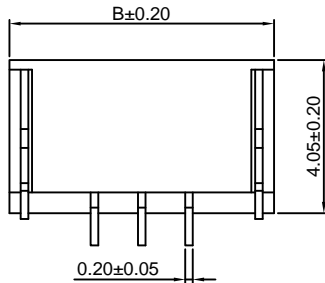
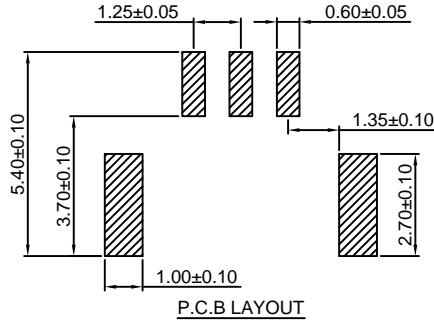
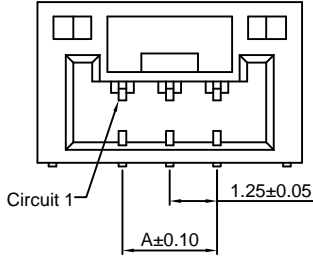
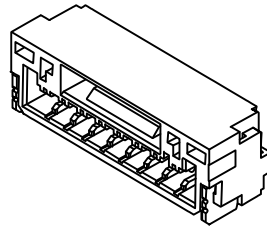

Ordering Information:

A1257WR-S-XP - *** - *** - *
1 2 3 4

- 1.Part No.
- 2.Material:
(Blank):Nylon 9T,UL94V-0
GWT:Nylon 9T,UL94V-0,GWT 750°C
- 3.Color:
(Blank):Ivory
BK:Black BL:Blue
OR:Orange LE:Light blue
TR:Tomato red LY:Lemon yellow
MG:Moss green DPK:Dark pink
- 4.Finish:
(Blank):Tin over Nickel
G:Gold over Nickel

Ordering Information & Dimensions:

PART NO.	Dimensions	
	A	B
2P	1.25	5.75
3P	2.50	7.00
4P	3.75	8.25
5P	5.00	9.50
6P	6.25	10.75
7P	7.50	12.00
8P	8.75	13.25
9P	10.00	14.50
10P	11.25	15.75
11P	12.50	17.00
12P	13.75	18.25
13P	15.00	19.50
14P	16.25	20.75
15P	17.50	22.00

Unit: mm

X-ON Electronics

Largest Supplier of Electrical and Electronic Components

Click to view similar products for [Headers & Wire Housings](#) category:

Click to view products by [Changjiang](#) manufacturer:

Other Similar products are found below :

[95000-104TRLF](#) [10135584-644402LF](#) [DF62W-EP2022PCA](#) [95000-106TRLF](#) [DF62W-2022SCA](#) [DF62W-EP2022PC](#) [2203348](#) [DF62W-2022SC](#) [1084018](#) [1029039](#) [1084017](#) [802-10-012-10-002000](#) [1112640](#) [1112639](#) [891-007-9SS-BST1T](#) [000-34000](#) [0008550134](#) [0009482033](#) [0009507031](#) [57102-F02-18ULF](#) [57102-S06-03LF](#) [57202-S52-04LF](#) [PCN6-15S-2.5E](#) [0039019024](#) [58102-G61-06LF](#) [582553-1](#) [0009485154](#) [0009508121](#) [0022285053](#) [0050291907](#) [018731A](#) [LY20-4P-DT1-P1E-BR](#) [02.125.8002.8](#) [60101931](#) [60598-1 \(Cut Strip\)](#) [M1625-3R/100](#) [61062-3](#) [61082-181009](#) [CSU011177004](#) [636-1427](#) [638009-1](#) [641938-9](#) [641991-4](#) [644168-1](#) [644827-2](#) [647662-1](#) [65039-019ELF](#) [65692-001LF](#) [65781-018](#) [65781-047](#)