

## Specifications

Current rating:1A AC,DC  
Voltage rating:50V AC,DC  
Temperature range:-40°C~+105°C  
Contact resistance:30mΩMax.  
Insulation resistance:100MΩMin.  
Withstanding voltage:500V AC/minute  
\*Compliant with RoHS and REACH\*  
\*Meet the HF/Halogen Free,need to customize\*  
\*Contact CJT for details\*

## Standards



## Assembly layout

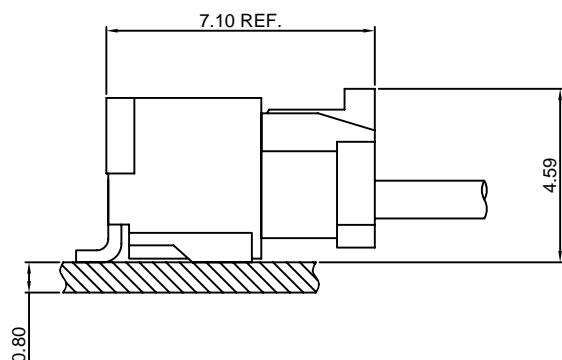
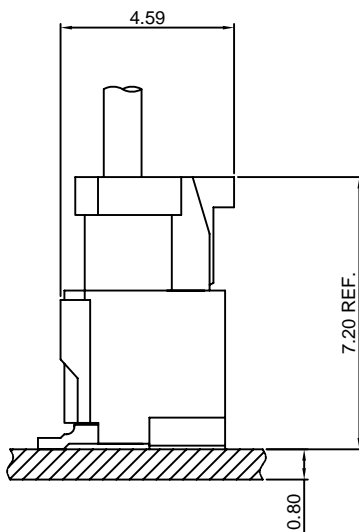

# A1257-T

1.25mm pitch Crimp Terminal

#### Reference Informations:

\*Used in CJT A1257H-XP, A1257HA-XP series Housing

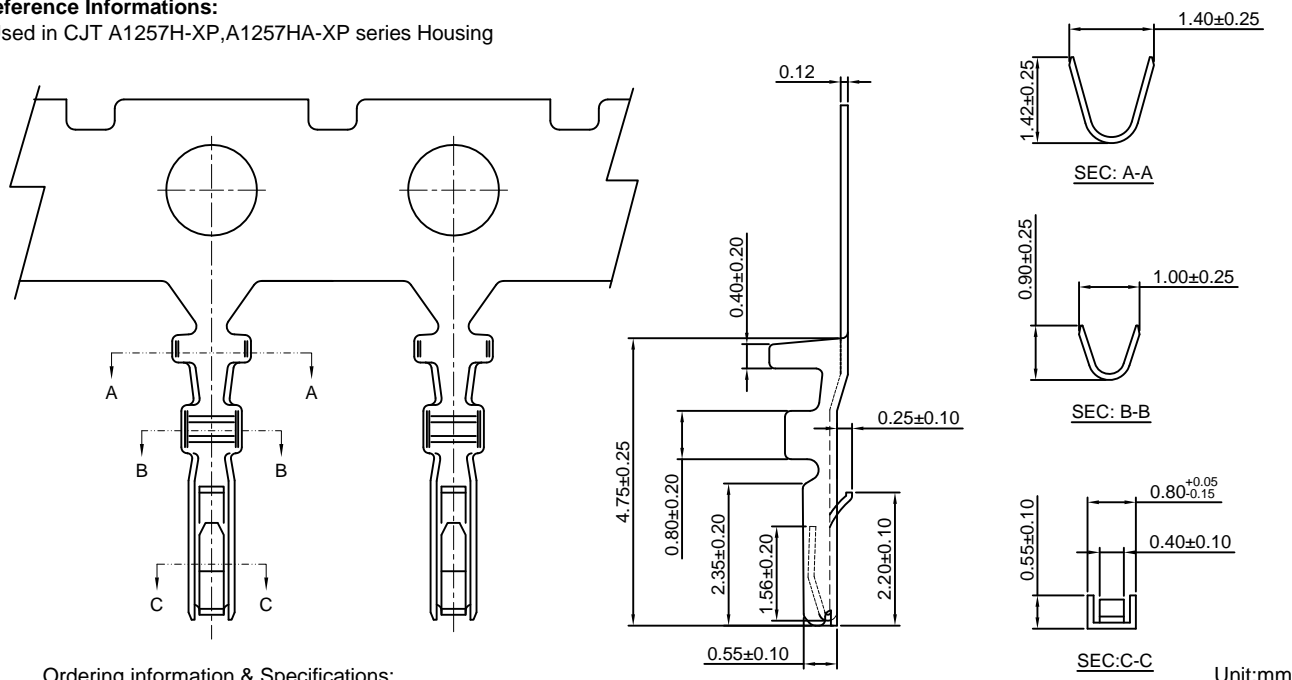

Ordering information & Specifications:

Part NO	Wire Range	Insulation O.D.	Material	Finish	Qty/reel
A1257-TP	AWG#28-#32	1.00mm(max)	Phosphor Bronze	Tin over Nickel	20,000 PCS
A1257-GP	AWG#28-#32	1.00mm(max)	Phosphor Bronze	Gold over Nickel	20,000 PCS

Unit:mm

Optional Gold plating available but MOQ requested

# A1257H-XP

1.25mm pitch Housing

#### Reference Informations:

\*Material:Nylon 66,UL94V-0

\*Suitable CJT A1257-T series Terminal

\*Mates with CJT A1257WV-S,WR-S-XP series Wafer

\*Color:White

#### Ordering Information:

A1257H-XP - \*\*\* - \*\*\*  
1 2 3

1.Part No.

2.Material:

(Blank):Nylon 66,UL94V-0

GWT:Nylon 66,UL94V-0,GWT 750 °C

3.Color:

(Blank):White

BK:Black

OR:Orange

TR:Tomato red

MG:Moss green

BL:Blue

LE:Light blue

LY:Lemon yellow

DPK:Dark pink

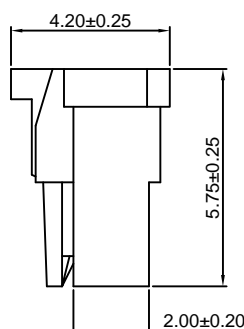
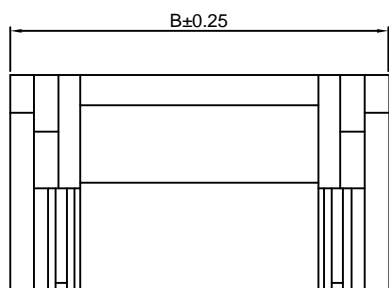
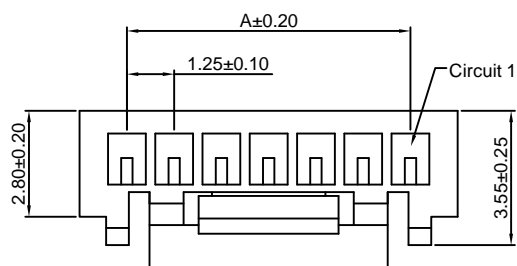
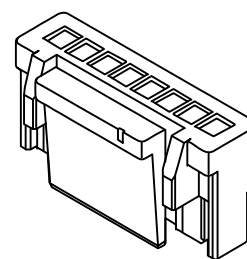

#### Ordering Information & Dimensions:

PART NO.	Dimensions	
	A	B
2P	1.25	3.75
3P	2.50	5.00
4P	3.75	6.25
5P	5.00	7.50
6P	6.25	8.75
7P	7.50	10.00
8P	8.75	11.25
9P	10.00	12.50
10P	11.25	13.75
11P	12.50	15.00
12P	13.75	16.25
13P	15.00	17.50
14P	16.25	18.75
15P	17.50	20.00

Unit: mm

### A1257HA-XP

1.25mm pitch Housing

**Reference Informations:**

- \*Material:PBT,UL94V-0
- \*Suitable CJT A1257-T series Terminal
- \*Color:White

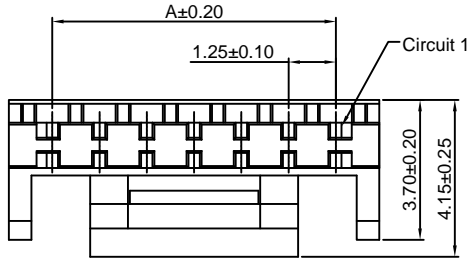

Ordering Information:  
**A1257HA-XP - \*\*\***  
 1                    2  
 1.Part No.  
 2.Material:  
 (Blank):PBT,UL94V-0  
 GWT:PBT,UL94V-0,GWT 750°C

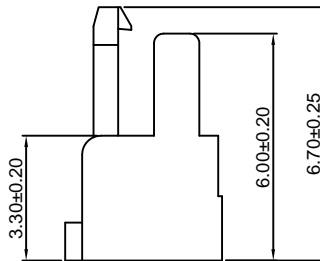
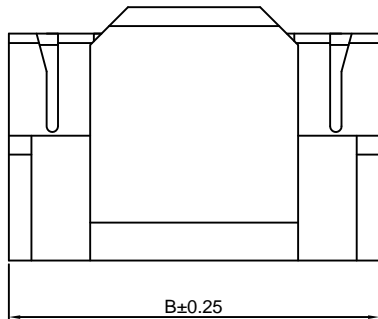
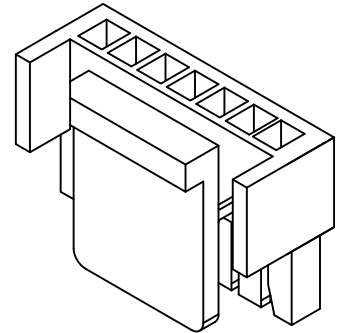

**Ordering Information & Dimensions:**

PART NO.	Dimensions	
	A	B
4P	3.75	6.05
5P	5.00	7.30
7P	7.50	9.80
8P	8.75	11.05
10P	11.25	13.56

Unit: mm

### A1257WV-S-XP

1.25mm pitch 180° Wafer-SMT TYPE

**Reference Informations:**

- \*Material:Pin:Brass/Tin over Nickel  
Insulator:Nylon 9T,UL94V-0
- \*Mates with CJT A1257H-XP series Housing
- \*Color:Ivory

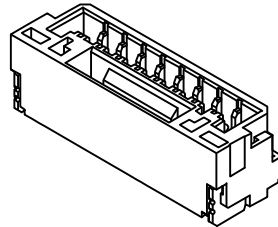

Ordering Information:  
**A1257WV-S-XP - \*\*\* - \*\*\* - \***  
 1                    2                    3                    4  
 1.Part No.  
 2.Material:  
 (Blank):Nylon 9T,UL94V-0  
 GWT:Nylon 9T,UL94V-0,GWT 750°C  
 3.Color:  
 (Blank):Ivory  
 BK:Black                    BL:Blue  
 OR:Orange                LE:Light blue  
 TR:Tomato red           LY:Lemon yellow  
 MG:Moss green         DPK:Dark pink  
 4.Finish:  
 (Blank):Tin over Nickel  
 G:Gold over Nickel

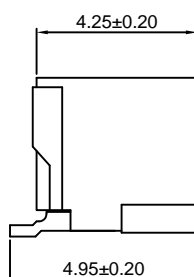
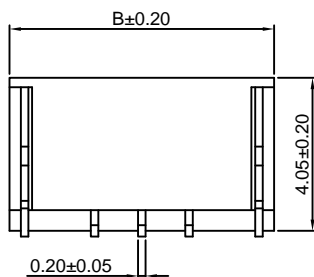
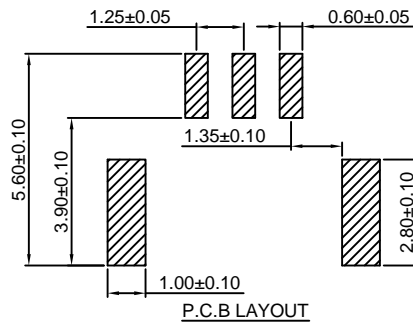
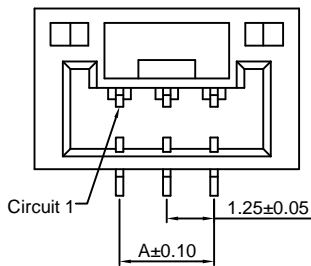

**Ordering Information & Dimensions:**

PART NO.	Dimensions	
	A	B
2P	1.25	5.75
3P	2.50	7.00
4P	3.75	8.25
5P	5.00	9.50
6P	6.25	10.75
7P	7.50	12.00
8P	8.75	13.25
9P	10.00	14.50
10P	11.25	15.75
11P	12.50	17.00
12P	13.75	18.25
13P	15.00	19.50
14P	16.25	20.75
15P	17.50	22.00

Unit: mm

# A1257WR-S-XP

1.25mm pitch 90° Wafer-SMT TYPE

#### Reference Informations:

- \*Material: Pin: Brass/Tin over Nickel  
Insulator: Nylon 9T, UL94V-0
- \*Mates with CJT A1257H-XP series Housing
- \*Color: Ivory

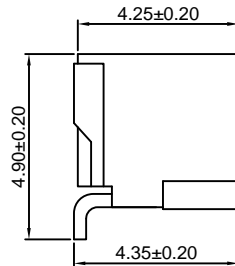
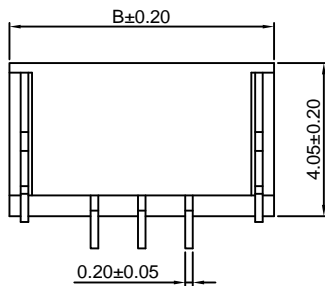
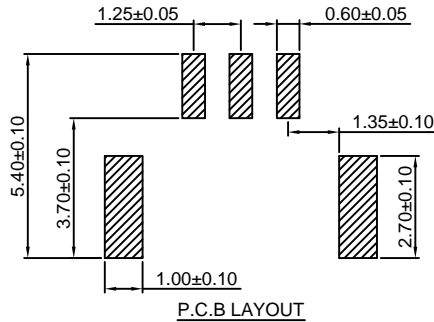
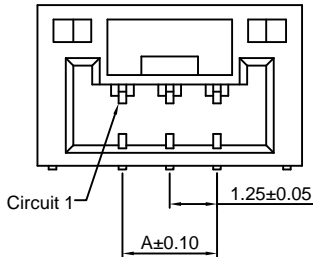
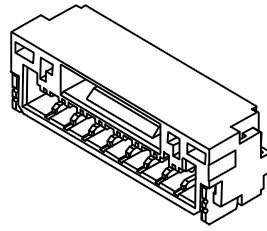

#### Ordering Information:

A1257WR-S-XP - \*\*\* - \*\*\* - \*  
1 2 3 4

1. Part No.

2. Material:

(Blank): Nylon 9T, UL94V-0

GWT: Nylon 9T, UL94V-0, GWT 750°C

3. Color:

(Blank): Ivory

BK: Black

BL: Blue

OR: Orange

LE: Light blue

TR: Tomato red

LY: Lemon yellow

MG: Moss green

DPK: Dark pink

4. Finish:

(Blank): Tin over Nickel

G: Gold over Nickel

#### Ordering Information & Dimensions:

PART NO.	Dimensions	
	A	B
2P	1.25	5.75
3P	2.50	7.00
4P	3.75	8.25
5P	5.00	9.50
6P	6.25	10.75
7P	7.50	12.00
8P	8.75	13.25
9P	10.00	14.50
10P	11.25	15.75
11P	12.50	17.00
12P	13.75	18.25
13P	15.00	19.50
14P	16.25	20.75
15P	17.50	22.00

Unit: mm

## X-ON Electronics

Largest Supplier of Electrical and Electronic Components

*Click to view similar products for [Headers & Wire Housings](#) category:*

*Click to view products by [Changjiang](#) manufacturer:*

Other Similar products are found below :

[57102-F02-18ULF](#) [58102-G61-06LF](#) [582553-1](#) [009176003701906](#) [0050291907](#) [02.125.8002.8](#) [609-3404](#) [61062-3](#) [622-0430](#) [622-3653LF](#)  
[63453-116](#) [636-1030](#) [636-1427](#) [636-3427](#) [636-4007](#) [641938-9](#) [65495-038](#) [65692-001LF](#) [65781-018](#) [65781-047](#) [65817-010LF](#) [65817-015LF](#)  
[66207-023LF](#) [67016-026LF](#) [67095-007LF](#) [68631-112](#) [68645-018](#) [68648-049](#) [699319-000](#) [M90C108951C](#) [70.362.1628.0](#) [70-4210](#) [70-4226B](#)  
[70-4853B](#) [707-5020](#) [707-5028](#) [71.350.2428.0](#) [71961-016LF](#) [733-134](#) [754199-000](#) [760-3052](#) [787-8014-00](#) [FCN-367T-T012/H](#)  
[80.063.4001.1](#) [800-90-001-10-001000](#) [801-43-002-10-013000](#) [801-43-006-10-002000](#) [803-41-018-10-001000](#) [803-43-014-20-001000](#)  
[803-43-024-10-001000](#)