

Specifications

- Current rating:1A AC,DC
- Voltage rating:100V AC,DC
- Temperature range:-40°C~+105°C
- Contact resistance:20mΩMax.
- Insulation resistance:500MΩMin.
- Withstanding voltage:500V AC/minute
- *Compliant with RoHS and REACH*
- *Meet the HF/Halogen Free,need to customize*
- *Contact CJT for details*

Standards

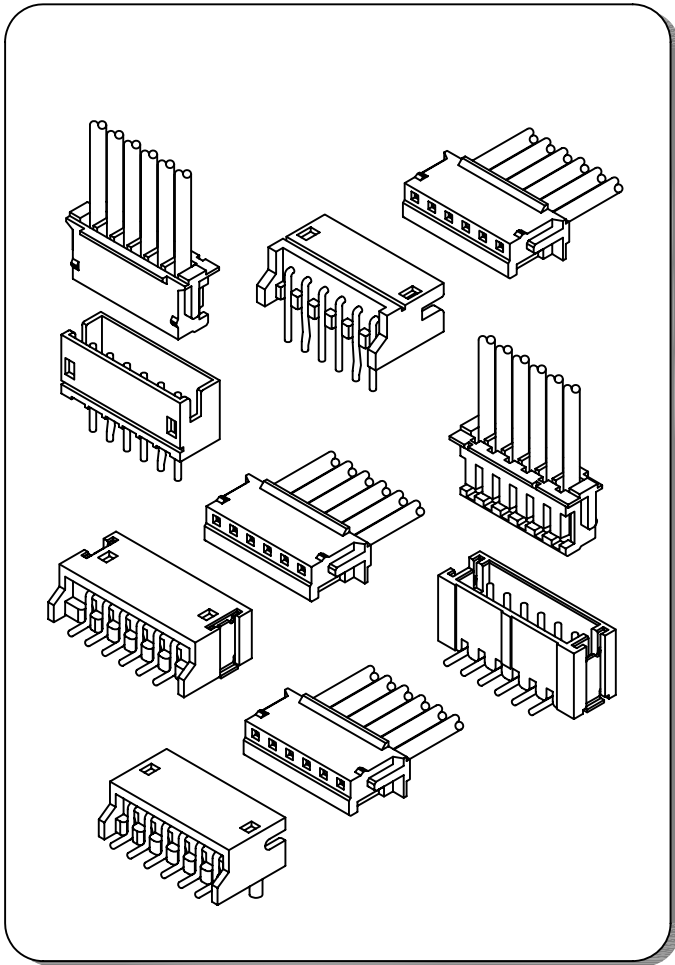

Assembly layout

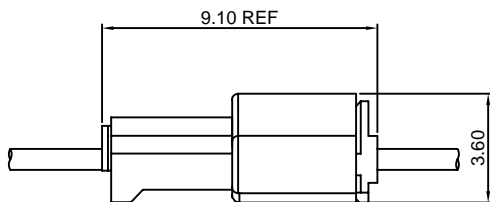

wire to wire

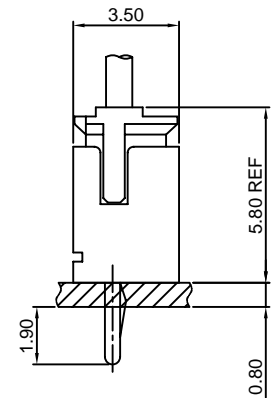
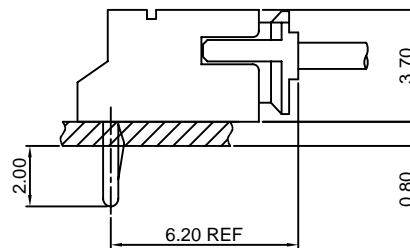

DIP TYPE

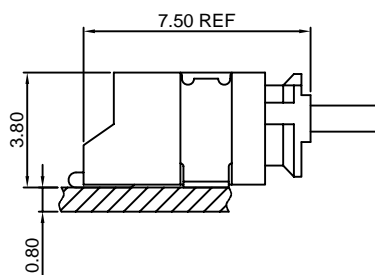
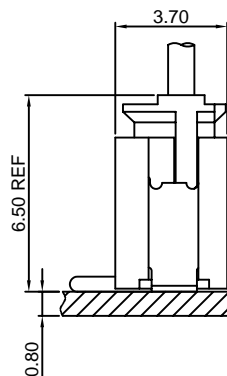

SMT TYPE

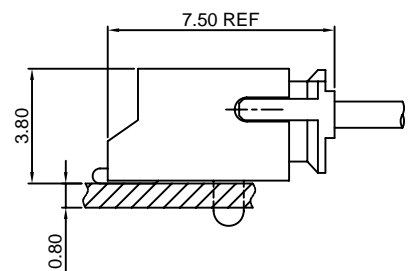

A1501-T

1.50mm pitch Crimp Terminal

Reference Informations:

*Used in CJT A1501H-XP series Housing

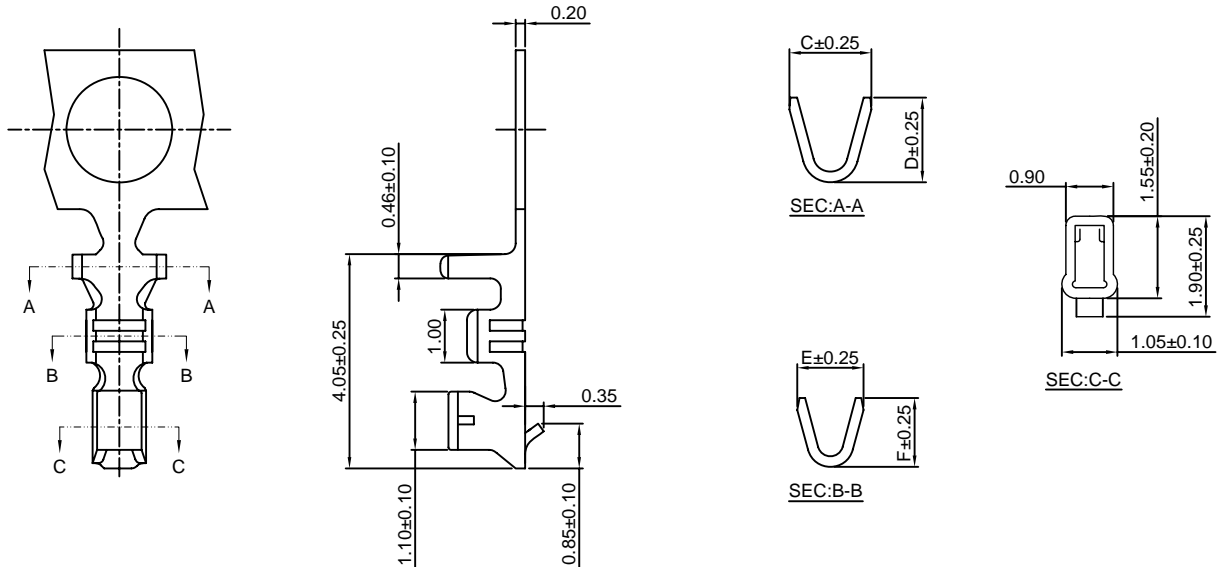

Ordering information & Specifications:

Unit:mm

Part NO.	Wire Range	Insulation O.D.	Material	Finish	C	D	E	F	Qty/reel
A1501-TP	AWG#26-#32	1.10mm(max)	Phosphor Bronze	Tin over Nickel	1.55	1.60	1.25	1.30	10,000 PCS
A1501-GP	AWG#26-#32	1.10mm(max)	Phosphor Bronze	Gold over Nickel	1.55	1.60	1.25	1.30	10,000 PCS
A1501-TP-H	AWG#24-#30	1.50mm(max)	Phosphor Bronze	Tin over Nickel	1.80	1.85	1.25	1.30	15,000 PCS
A1501-GP-H	AWG#24-#30	1.50mm(max)	Phosphor Bronze	Gold over Nickel	1.80	1.85	1.25	1.30	15,000 PCS

Optional Gold plating available but MOQ requested

A1501-T-A

1.50mm pitch Crimp Terminal

Reference Informations:

*Used in CJT A1501HA-XP series Housing

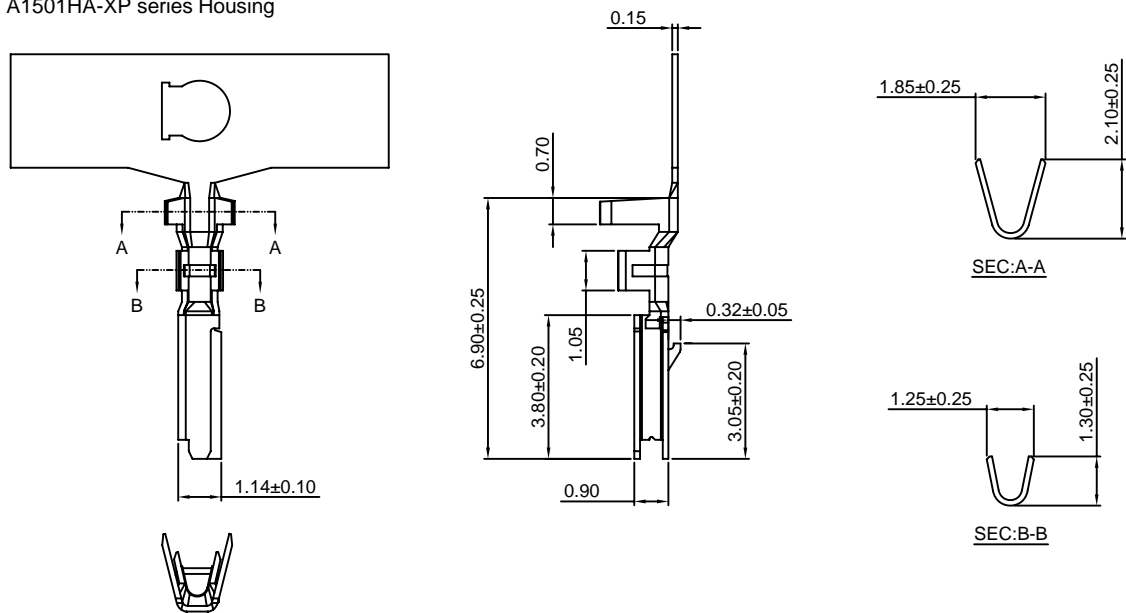

Ordering information & Specifications:

Unit:mm

Part NO.	Wire Range	Insulation O.D.	Material	Finish	Qty/reel
A1501-TP-A	AWG#24-#28	1.28mm(max)	Phosphor Bronze	Tin over Nickel	10,000 PCS
A1501-GP-A	AWG#24-#28	1.28mm(max)	Phosphor Bronze	Gold over Nickel	10,000 PCS

Optional Gold plating available but MOQ requested

A1501-T-B

1.50mm pitch Crimp Terminal

Reference Informations:

*Used in CJT A1501HB-XP series Housing

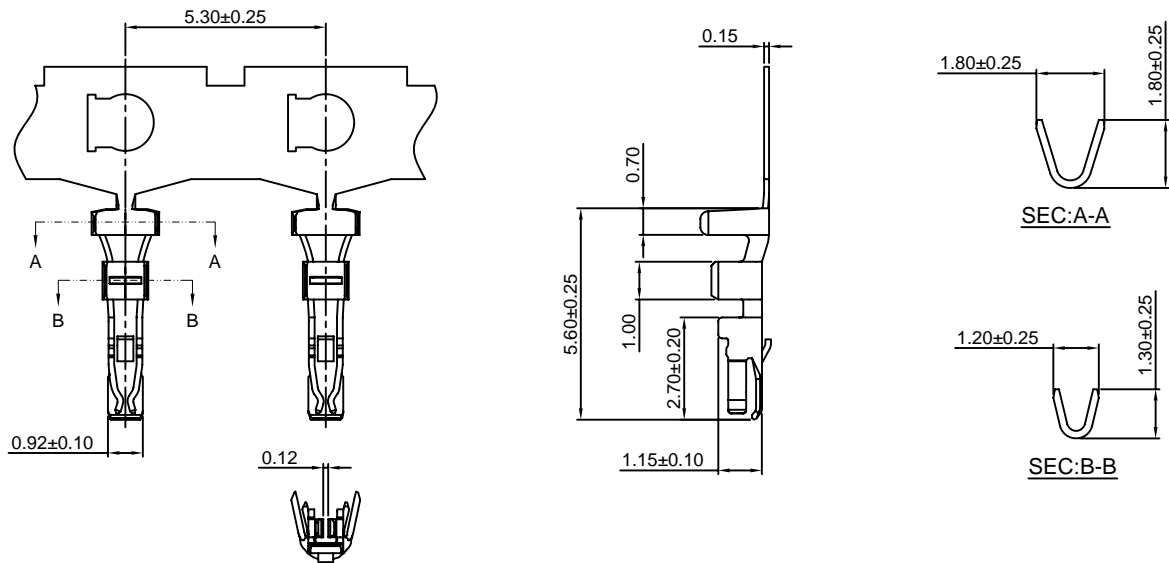

Ordering information & Specifications:

Unit:mm

Part NO.	Wire Range	Insulation O.D.	Material	Finish	Qty/reel
A1501-TP-B	AWG#28-#32	1.10mm(max)	Phosphor Bronze	Tin over Nickel	10,000 PCS
A1501-GP-B	AWG#28-#32	1.10mm(max)	Phosphor Bronze	Gold over Nickel	10,000 PCS

Optional Gold plating available but MOQ requested

A1501M-T

1.50mm pitch Crimp Terminal

Reference Informations:

*Used in CJT A1501HM-XP series Housing

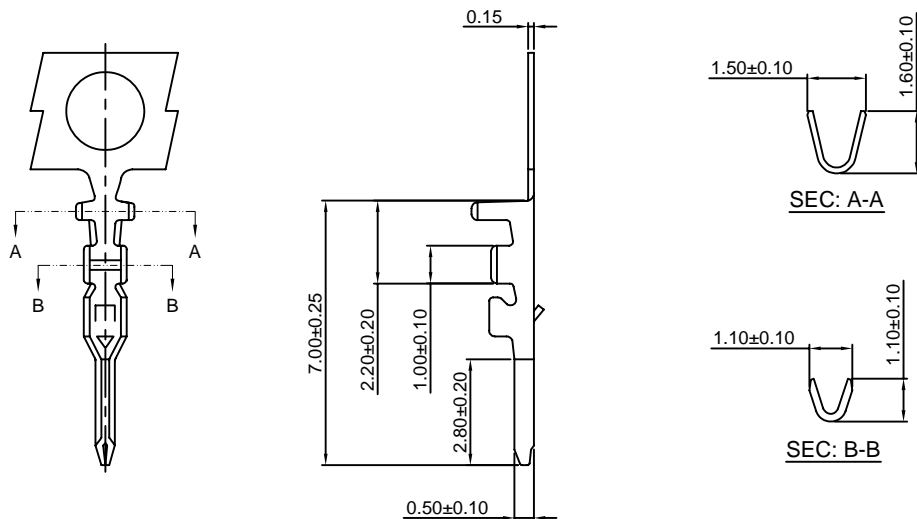

Ordering information & Specifications:

Unit:mm

Part NO.	Wire Range	Insulation O.D.	Material	Finish	Qty/reel
A1501M-TP	AWG#28-#32	0.90mm(max)	Phosphor Bronze	Tin over Nickel	15,000 PCS
A1501M-GP	AWG#28-#32	0.90mm(max)	Phosphor Bronze	Gold over Nickel	15,000 PCS

Optional Gold plating available but MOQ requested

A1501H-XP

1.50mm pitch Housing

Reference Informations:

- *Material:Nylon 66,UL94V-0
- *Suitable CJT A1501-T(H) series Terminal
- *Mates with CJT A1501HM-XP series Housing and A1501WV,WR,WV-S,WR-S-XP series Wafer
- *Color:White

Ordering Information:

A1501H-XP - ***
1 2

1.Part No.

2.Material:

(Blank):Nylon 66,UL94V-0

GWT:Nylon 66,UL94V-0 GWT 750 °C

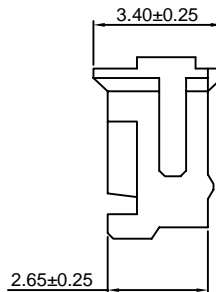
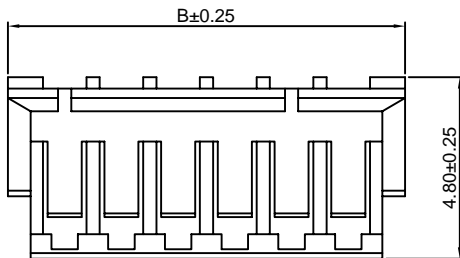
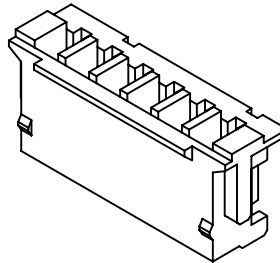
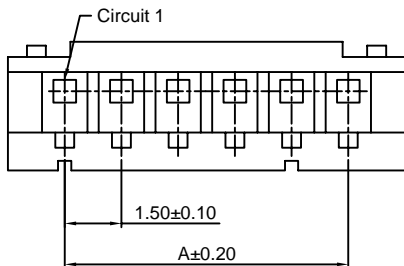

Ordering Information & Dimensions:

PART NO.	Dimensions	
	A	B
2P	1.50	4.50
3P	3.00	6.00
4P	4.50	7.50
5P	6.00	9.00
6P	7.50	10.50
7P	9.00	12.00
8P	10.50	13.50
9P	12.00	15.00
10P	13.50	16.50
11P	15.00	18.00
12P	16.50	19.50
13P	18.00	21.00
15P	21.00	24.00

Unit: mm

A1501HA-XP

1.50mm pitch Housing

Reference Informations:

- *Material:PBT,UL94V-0
- *Suitable CJT A1501-T-A series Terminal
- *Mates with CJT A1501WVA-S,WRA-S-XP series Wafer
- *Color:Beige

Ordering Information:

A1501HA-XP - ***
1 2

1.Part No.

2.Material:

(Blank):PBT,UL94V-0

GWT:PBT,UL94V-0 GWT 750 °C

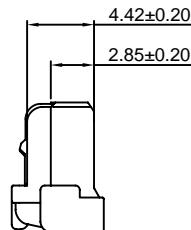
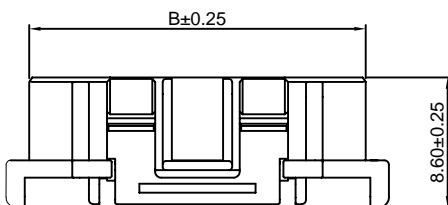
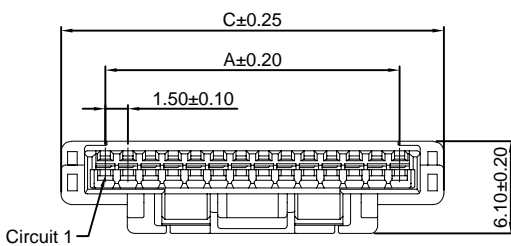
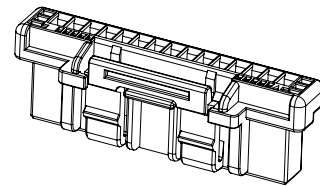

Ordering Information & Dimensions:

PART NO.	Dimensions		
	A	B	C
2P	1.50	4.25	7.30
3P	3.00	5.75	8.80
4P	4.50	7.25	10.30
5P	6.00	8.75	11.80
6P	7.50	10.25	13.30
7P	9.00	11.75	14.80
8P	10.50	13.25	16.30
9P	12.00	14.75	17.80
10P	13.50	16.25	19.30
11P	15.00	17.75	20.80
12P	16.50	19.25	22.30
13P	18.00	20.75	23.80
14P	19.50	22.25	25.30
15P	21.00	23.75	26.80

Unit: mm

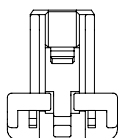

2P,3P

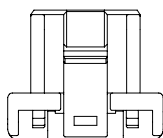

4P,5P

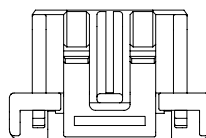

6P~15P

A1501HB-XP

1.50mm pitch Housing

Reference Informations:

- *Material:Nylon 66,UL94V-0
- *Suitable CJT A1501-T-B series Terminal
- *Mates with CJT A1501WRB-S-XP series Wafer
- *Color:Black

Ordering Information:

- A1501HB-XP - ***
 1 2
 1.Part No.
 2.Material:
 (Blank):Nylon 66,UL94V-0
 GWT:Nylon 66,UL94V-0 GWT 750 °C

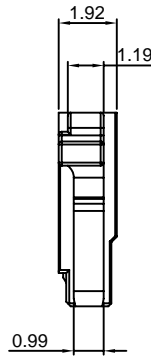
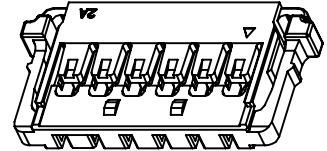
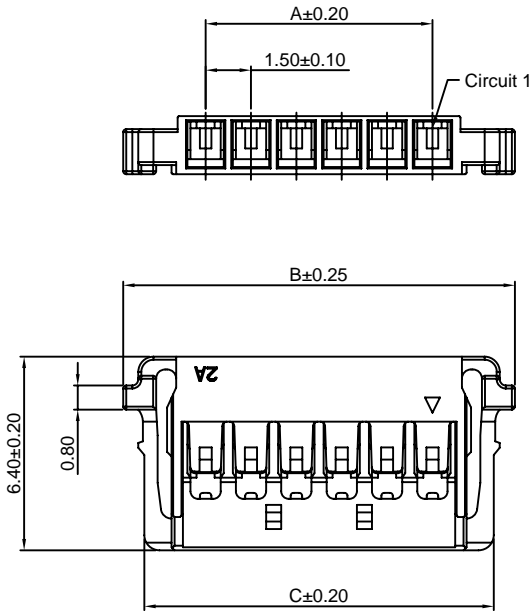

Ordering Information & Dimensions:

PART NO.	Dimensions		
	A	B	C
2P	1.50	6.95	5.55
3P	3.00	8.45	7.05
4P	4.50	9.95	8.55
5P	6.00	11.45	10.05
6P	7.50	12.95	11.55
7P	9.00	14.45	13.05
8P	10.50	15.95	14.55
9P	12.00	17.45	16.05
10P	13.50	18.95	17.55
11P	15.00	20.45	19.05
12P	16.50	21.95	20.55

Unit: mm

A1501HM-XP

1.50mm pitch Housing

Reference Informations:

- *Material:Nylon 66,UL94V-0
- *Suitable CJT A1501M-T series Terminal
- *Mates with CJT A1501H-XP series Housing
- *Color:White

Ordering Information:

- A1501HM-XP - ***
 1 2
 1.Part No.
 2.Material:
 (Blank):Nylon 66,UL94V-0
 GWT:Nylon 66,UL94V-0 GWT 750 °C

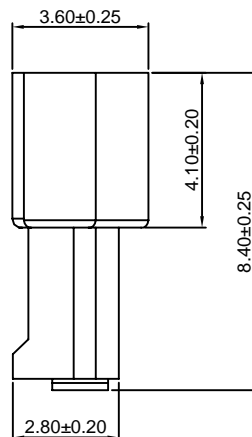
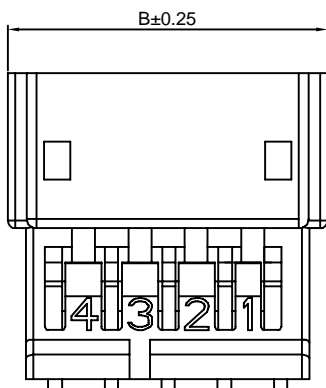
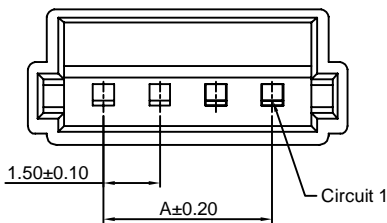

Ordering Information & Dimensions:

PART NO.	Dimensions	
	A	B
2P	1.50	5.55
3P	3.00	7.05
4P	4.50	8.55
5P	6.00	10.05
6P	7.50	11.55
7P	9.00	13.05
8P	10.50	14.55
9P	12.00	16.05
10P	13.50	17.55
11P	15.00	19.05
12P	16.50	20.55
13P	18.00	22.05

Unit: mm

A1501WV-XP

1.50mm pitch 180° Wafer

Reference Informations:

- *Material: Pin: Brass/Tin over Nickel
Insulator: Nylon 66, UL94V-0
- *Mates with CJT A1501H-XP series Housing
- *Color: Ivory

Ordering Information:

- A1501WV-XP - ** - ***
 1 2 3
1. Part No.
 2. Color:
(blank): Ivory
WH: White
 3. Material:
(Blank): Nylon 66, UL94V-0
GWT: Nylon 66, UL94V-0 GWT 750°C

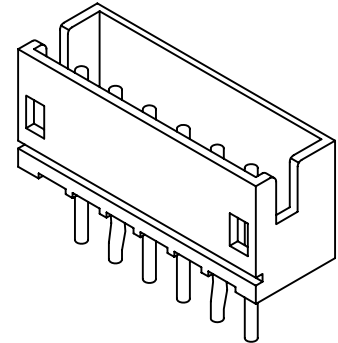
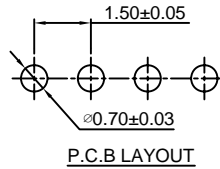
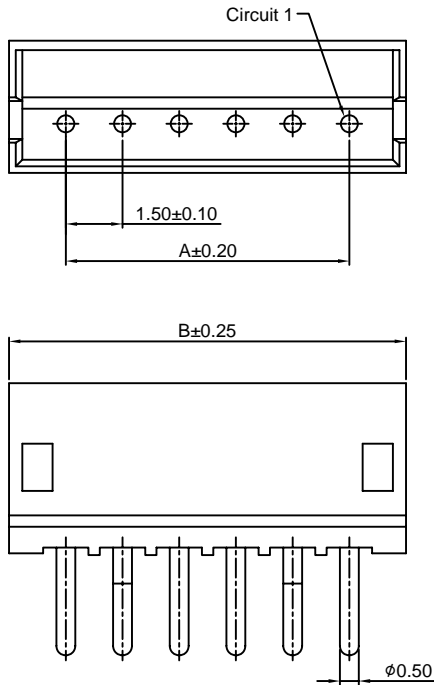

Ordering Information & Dimensions:

PART NO.	Dimensions	
	A	B
2P	1.50	4.50
3P	3.00	6.00
4P	4.50	7.50
5P	6.00	9.00
6P	7.50	10.50
7P	9.00	12.00
8P	10.50	13.50
9P	12.00	15.00
10P	13.50	16.50
11P	15.00	18.00
12P	16.50	19.50
13P	18.00	21.00
15P	21.00	24.00

Unit: mm

A1501WR-XP

1.50mm pitch 90° Wafer

Reference Informations:

- *Material: Pin: Brass/Tin over Nickel
Insulator: Nylon 66, UL94V-0
- *Mates with CJT A1501H-XP series Housing
- *Color: Ivory

Ordering Information:

- A1501WR-XP - ** - ***
 1 2 3
1. Part No.
 2. Color:
(blank): Ivory
White: White
 3. Material:
(Blank): Nylon 66, UL94V-0
GWT: Nylon 66, UL94V-0 GWT 750°C

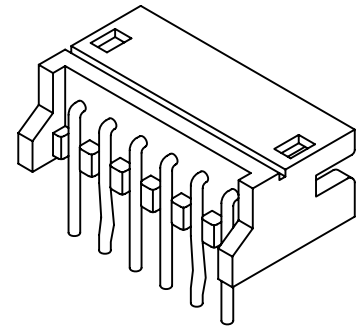
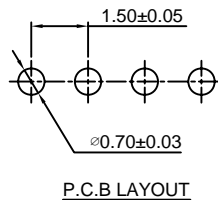
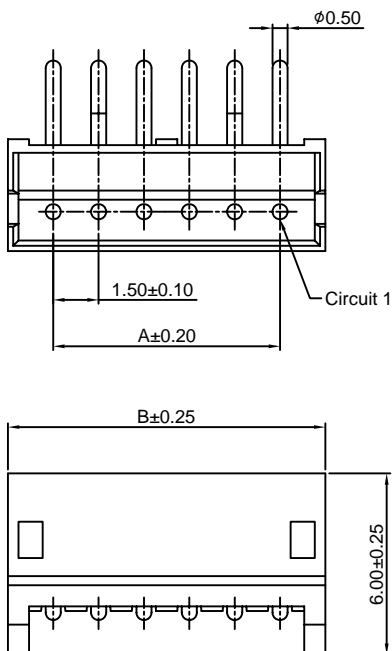

Ordering Information & Dimensions:

PART NO.	Dimensions	
	A	B
2P	1.50	4.50
3P	3.00	6.00
4P	4.50	7.50
5P	6.00	9.00
6P	7.50	10.50
7P	9.00	12.00
8P	10.50	13.50
9P	12.00	15.00
10P	13.50	16.50
11P	15.00	18.00
12P	16.50	19.50
13P	18.00	21.00
15P	21.00	24.00

Unit: mm

A1501WV-S-XP

1.50mm pitch 180° Wafer-SMT TYPE

Reference Informations:

*Material:Pin:Brass/Tin over Nickel
Solder Tabs:Brass/Gold over Nickel
Insulator:Nylon 6T,UL94V-0
Cap:Nylon 6T,UL94V-0

*Mates with CJT A1501H-XP series Housing
*Color:Ivory

Ordering Information:

A1501WV-S-XP - ***
1 2

1.Part No.
2.Material:
(Blank):Nylon 6T,UL94V-0
GWT:Nylon 6T,UL94V-0 GWT 750°C

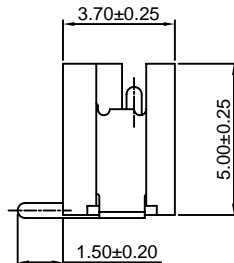
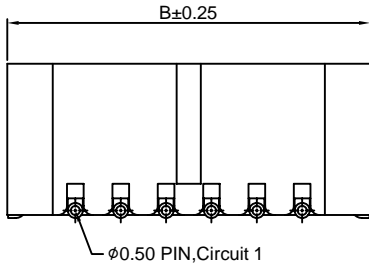
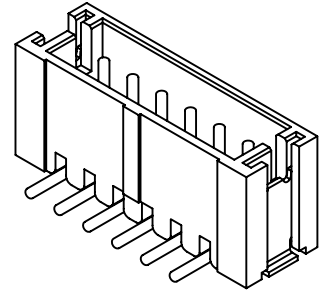
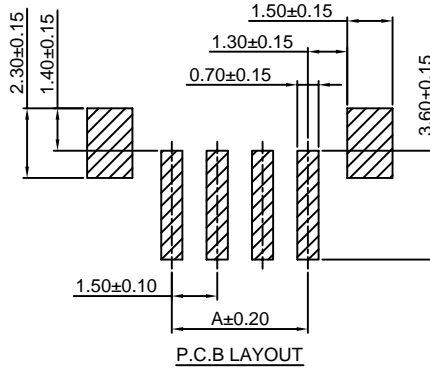
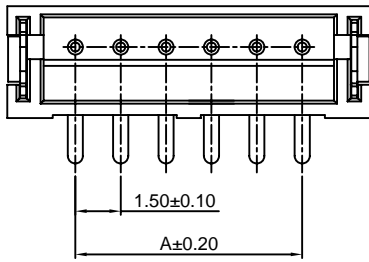

Ordering Information & Dimensions:

PART NO.	Dimensions	
	A	B
2P	1.50	6.00
3P	3.00	7.50
4P	4.50	9.00
5P	6.00	10.50
6P	7.50	12.00
7P	9.00	13.50
8P	10.50	15.00
9P	12.00	16.50
10P	13.50	18.00
11P	15.00	19.50
12P	16.50	21.00
13P	18.00	22.50

Unit: mm

A1501WR-S-XP

1.50mm pitch 90° Wafer-SMT TYPE

Reference Informations:

*Material:Pin:Brass/Tin over Nickel
Solder Tabs:Brass/Gold over Nickel
Insulator:Nylon 6T,UL94V-0

*Mates with CJT A1501H-XP series Housing
*Color:Ivory

Ordering Information:

A1501WR-S-XP - ***
1 2

1.Part No.
2.Material:
(Blank):Nylon 6T,UL94V-0
GWT:Nylon 6T,UL94V-0 GWT 750°C

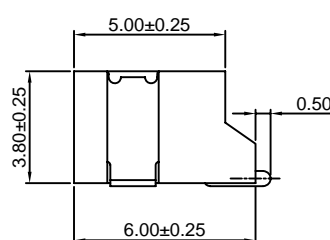
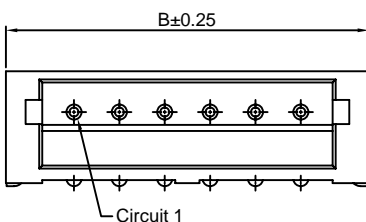
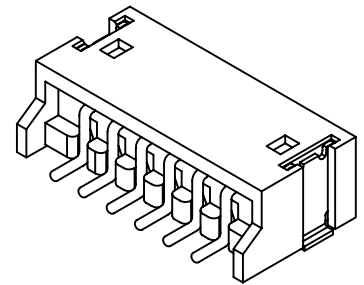
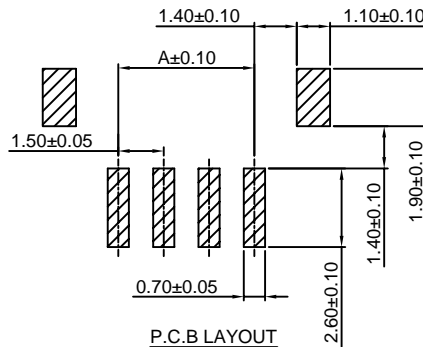
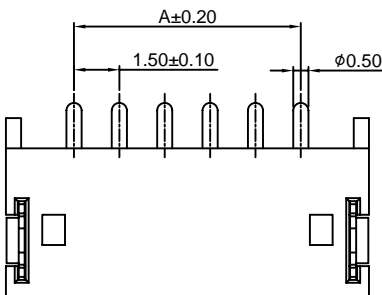

Ordering Information & Dimensions:

PART NO.	Dimensions	
	A	B
2P	1.50	6.00
3P	3.00	7.50
4P	4.50	9.00
5P	6.00	10.50
6P	7.50	12.00
7P	9.00	13.50
8P	10.50	15.00
9P	12.00	16.50
10P	13.50	18.00
11P	15.00	19.50
12P	16.50	21.00
13P	18.00	22.50

Unit: mm

A1501WR-S-XP-A

1.50mm pitch 90° Wafer DIP SMT TYPE

Reference Informations:

- *Material: Pin: Brass/Tin over Nickel
Solder Tabs: Brass/Gold over Nickel
Insulator: Nylon 6T, UL94V-0
- *Mates with CJT A1501H-XP series Housing
- *Color: Ivory

Ordering Information:

A1501WR-S-XP-A - ***
1 / 2

1. Part No.
2. Material:
(Blank): Nylon 6T, UL94V-0
GWT: Nylon 6T, UL94V-0 GWT 750 °C

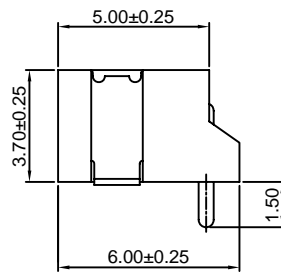
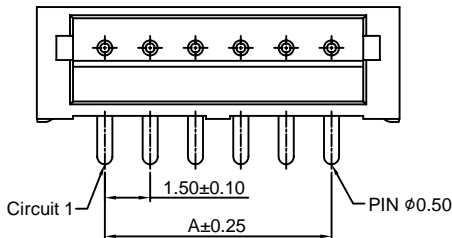
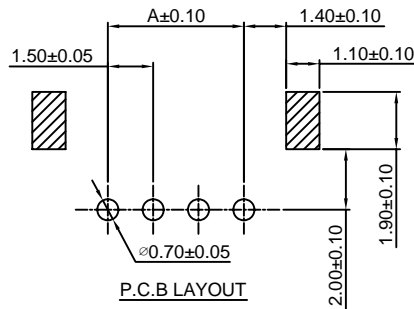
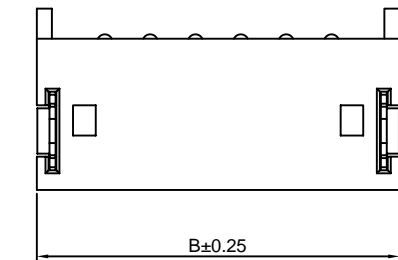
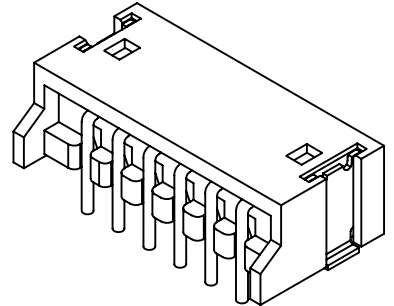

Ordering Information & Dimensions:

PART NO.	Dimensions	
	A	B
2P	1.50	6.00
3P	3.00	7.50
4P	4.50	9.00
5P	6.00	10.50
6P	7.50	12.00
7P	9.00	13.50
8P	10.50	15.00
9P	12.00	16.50
10P	13.50	18.00
11P	15.00	19.50
12P	16.50	21.00
13P	18.00	22.50

Unit: mm

A1501WVA-S-XP

1.50mm pitch 180° Wafer-SMT TYPE

Reference Informations:

- *Material: Pin: Phosphor Bronze/Tin over Nickel
Solder Tabs: Brass/Tin over Nickel
Insulator: LCP, UL94V-0
- *Mates with CJT A1501HA-XP series Housing
- *Color: Ivory

Ordering Information:

A1501WVA-S-XP - ***
1 / 2

1. Part No.
2. Material:
(blank): LCP, UL94V-0
GWT: LCP, UL94V-0 GWT 750 °C

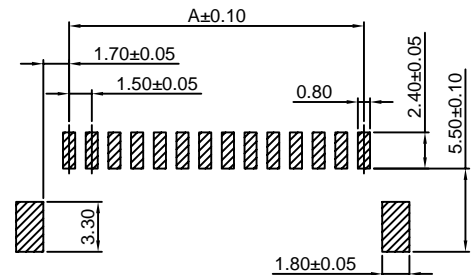

P.C.B LAYOUT

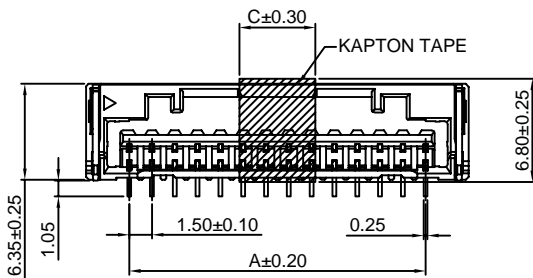

8P~15P
KAPTON TAPE FIGURE

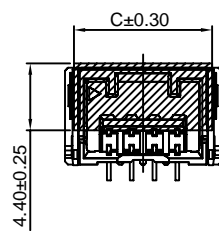

2P~7P
KAPTON TAPE FIGURE

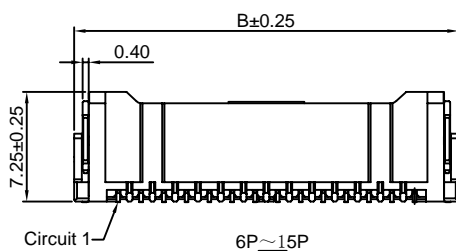

6P~15P

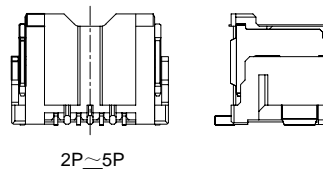

2P~5P

Ordering Information & Dimensions:

PART NO.	Dimensions		
	A	B	C
2P	1.50	7.30	6.10
3P	3.00	8.80	7.60
4P	4.50	10.30	9.10
5P	6.00	11.80	10.60
6P	7.50	13.30	12.10
7P	9.00	14.80	13.60
8P	10.50	16.30	5.00
9P	12.00	17.80	5.00
10P	13.50	19.30	5.00
11P	15.00	20.80	5.00
12P	16.50	22.30	5.00
13P	18.00	23.80	5.00
14P	19.50	25.30	5.00
15P	21.00	26.80	5.00

Unit: mm

A1501WRA-S-XP

1.50mm pitch 90° Wafer-SMT TYPE

Reference Informations:

- *Material:Pin:Phosphor Bronze/Tin over Nickel
Solder Tabs: Brass/Tin over Nickel
Insulator:LCP,UL94V-0
- *Mates with CJT A1501HA-XP series Housing
- *Color:Ivory

Ordering Information:

A1501WRA-S-XP - ***
1 2

- 1.Part No.
- 2.Material:
(Blank):LCP,UL94V-0
GWT:LCP,UL94V-0 GWT 750 °C

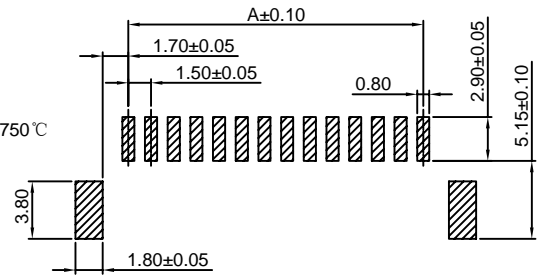

P.C.B LAYOUT

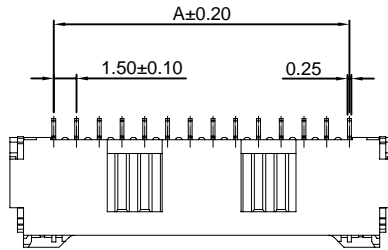

6P~15P

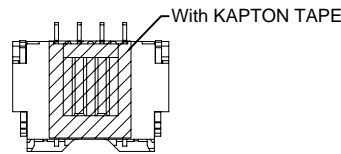
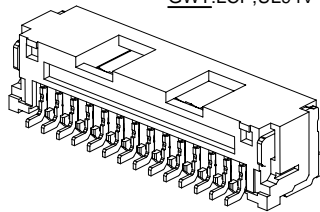

2P~5P

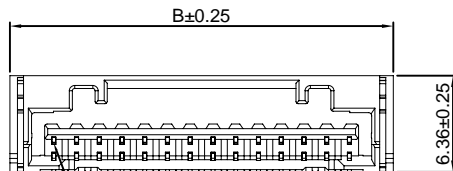

Circuit 1

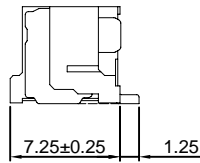

Ordering Information & Dimensions:

PART NO.	Dimensions	
	A	B
2P	1.50	7.30
3P	3.00	8.80
4P	4.50	10.30
5P	6.00	11.80
6P	7.50	13.30
7P	9.00	14.80
8P	10.50	16.30
9P	12.00	17.80
10P	13.50	19.30
11P	15.00	20.80
12P	16.50	22.30
13P	18.00	23.80
14P	19.50	25.30
15P	21.00	26.80

Unit: mm

A1501WRB-S-XP

1.50mm pitch 90° Wafer-SMT TYPE

Reference Informations:

- *Material:Pin:Brass/Tin over Nickel
Insulator:Nylon 9T,UL94V-0
- *Mates with CJT A1501HB-XP series Housing
- *Color:Ivory

Ordering Information:

A1501WRB-S-XP - ***
1 2

- 1.Part No.
- 2.Material:
(Blank):Nylon 9T,UL94V-0
GWT:Nylon 9T,UL94V-0 GWT 750 °C

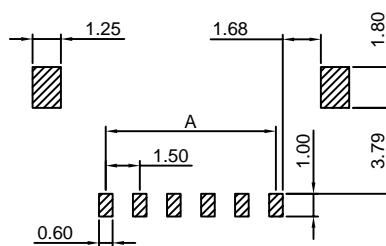
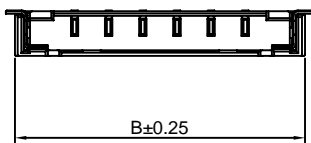

P.C.B LAYOUT

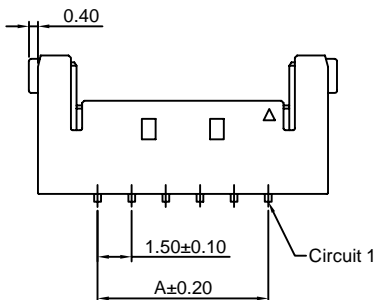

Circuit 1

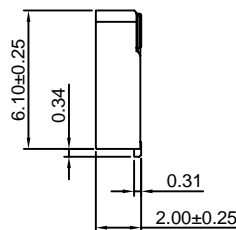

Ordering Information & Dimensions:

PART NO.	Dimensions	
	A	B
2P	1.50	6.75
3P	3.00	8.25
4P	4.50	9.75
5P	6.00	11.25
6P	7.50	12.75
7P	9.00	14.25
8P	10.50	15.75
9P	12.00	17.25
10P	13.50	18.75
11P	15.00	20.25
12P	16.50	21.75

Unit: mm

A1501WVD-S-XP

1.50mm pitch 180° Wafer-SMT TYPE

Reference Informations:

*Material:Pin:Phosphor Bronze/Tin over Nickel
Insulator:LCP,UL94V-0

*Color:Beige

Ordering Information:

A1501WVD-S-XP - ***
1 2

1.Part No.

2.Material:

(Blank):LCP,UL94V-0

GWT:LCP,UL94V-0 GWT 750°C

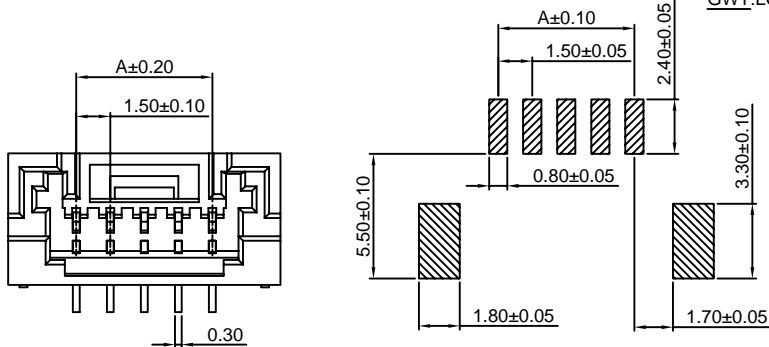

P.C.B LAYOUT

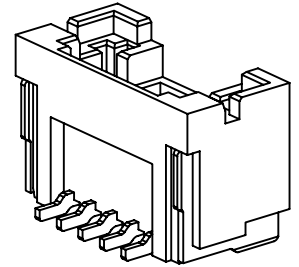
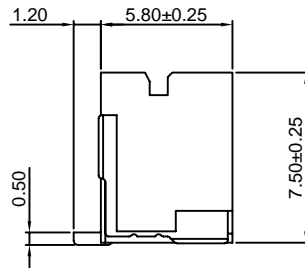
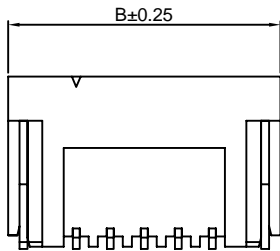

Ordering Information & Dimensions:

PART NO.	Dimensions	
	A	B
2P	1.50	7.50
3P	3.00	9.00
4P	4.50	10.50
5P	6.00	12.00
6P	7.50	13.50
7P	9.00	15.00
8P	10.50	16.50
9P	12.00	18.00
10P	13.50	19.50
11P	15.00	21.00
12P	16.50	22.50
13P	18.00	24.00
14P	19.50	25.50
15P	21.00	27.00
16P	22.50	28.50

Unit: mm

A1501WRD-S-XP

1.50mm pitch 90° Wafer-SMT TYPE

Reference Informations:

*Material:Pin:Phosphor Bronze/Tin over Nickel
Insulator:LCP,UL94V-0

*Color:Beige

Ordering Information:

A1501WRD-S-XP - ***
1 2

1.Part No.

2.Material:

(Blank):LCP,UL94V-0

GWT:LCP,UL94V-0 GWT 750°C

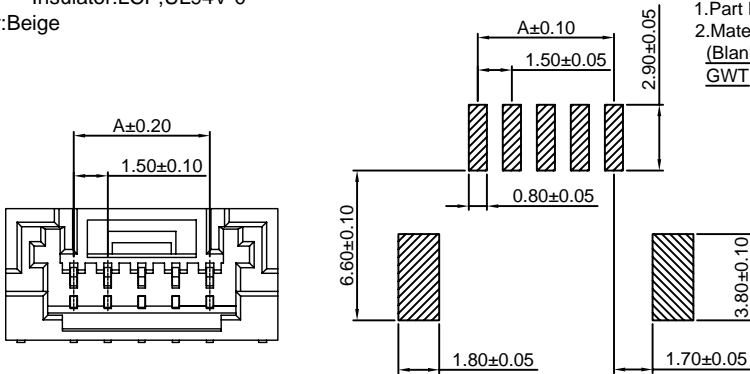

P.C.B LAYOUT

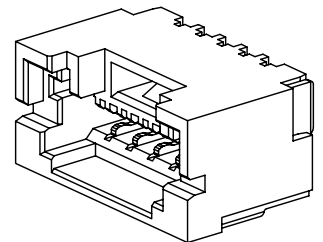
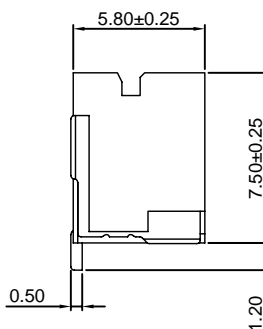
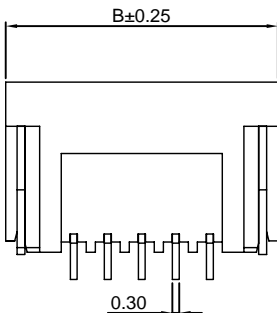

Ordering Information & Dimensions:

PART NO.	Dimensions	
	A	B
2P	1.50	7.50
3P	3.00	9.00
4P	4.50	10.50
5P	6.00	12.00
6P	7.50	13.50
7P	9.00	15.00
8P	10.50	16.50
9P	12.00	18.00
10P	13.50	19.50
11P	15.00	21.00
12P	16.50	22.50
13P	18.00	24.00
14P	19.50	25.50
15P	21.00	27.00
16P	22.50	28.50

Unit: mm

X-ON Electronics

Largest Supplier of Electrical and Electronic Components

Click to view similar products for [Headers & Wire Housings](#) category:

Click to view products by [Changjiang](#) manufacturer:

Other Similar products are found below :

[57102-F02-18ULF](#) [58102-G61-06LF](#) [0009485154](#) [009176003701906](#) [0050291907](#) [00-9021-0611-00-339](#) [02.125.8002.8](#) [609-3404](#) [61062-3](#)
[622-0430](#) [622-3653LF](#) [63453-116](#) [636-1030](#) [636-1427](#) [636-3427](#) [636-4007](#) [641938-9](#) [644827-2](#) [65495-038](#) [65692-001LF](#) [65781-018](#)
[65781-047](#) [65817-010LF](#) [65817-015LF](#) [66207-023LF](#) [67016-026LF](#) [67095-007LF](#) [68631-112](#) [68645-018](#) [68648-049](#) [699319-000](#)
[70.362.1628.0](#) [70-4210](#) [70-4226B](#) [70-4853B](#) [707-5020](#) [707-5028](#) [71.350.2428.0](#) [71961-016LF](#) [733-134](#) [754199-000](#) [760-3052](#) [787-8014-00](#)
[FCN-367T-T012/H](#) [80.063.4001.1](#) [800-90-001-10-001000](#) [800-90-010-10-002000](#) [801-43-002-10-013000](#) [801-43-006-10-002000](#)
[803-41-018-10-001000](#)