

### Specifications

- Current rating:1A AC,DC
- Voltage rating:100V AC,DC
- Temperature range:-40°C~+105°C
- Contact resistance:20mΩMax.
- Insulation resistance:500MΩMin.
- Withstanding voltage:500V AC/minute
- \*Compliant with RoHS and REACH\*
- \*Meet the HF/Halogen Free,need to customize\*
- \*Contact CJT for details\*

### Standards

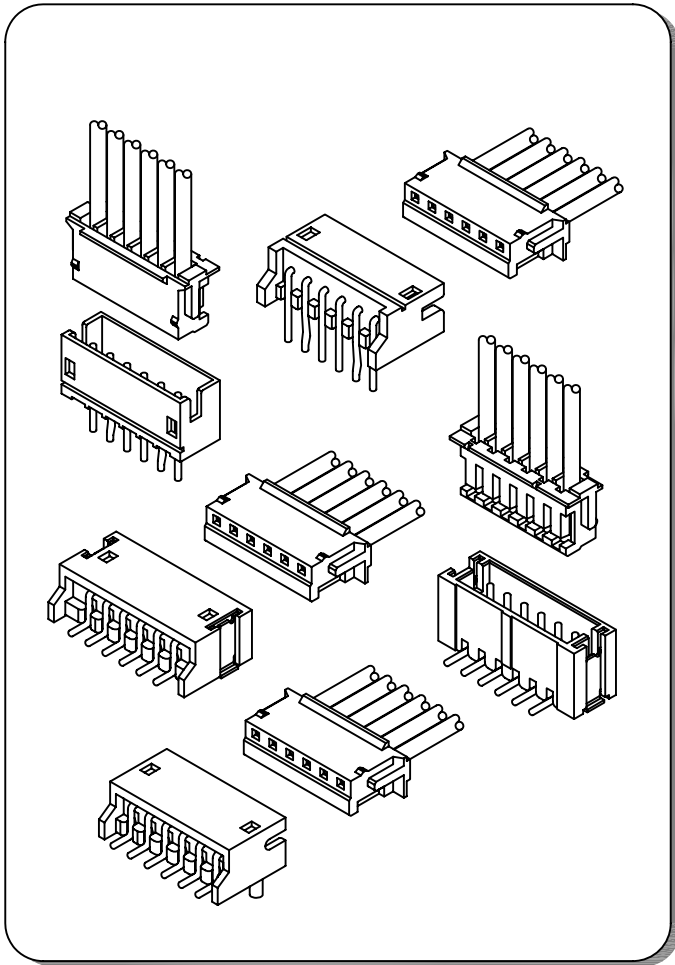

### Assembly layout

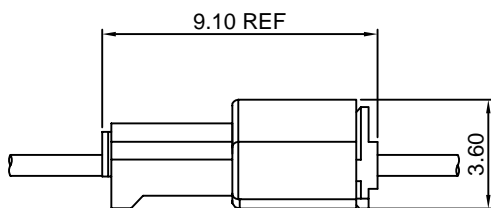

wire to wire

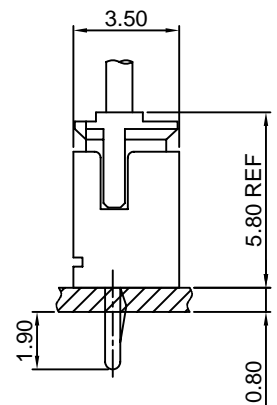
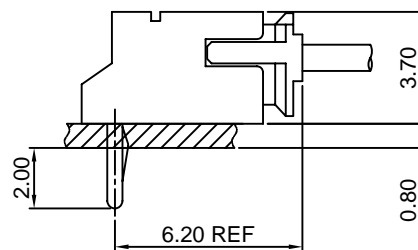

DIP TYPE

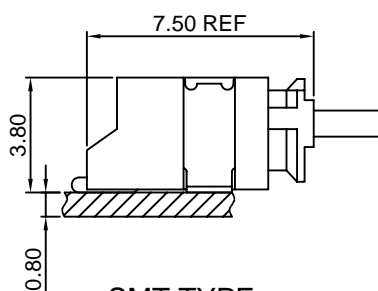
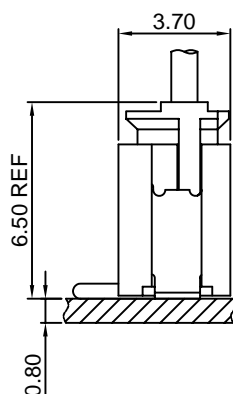

SMT TYPE

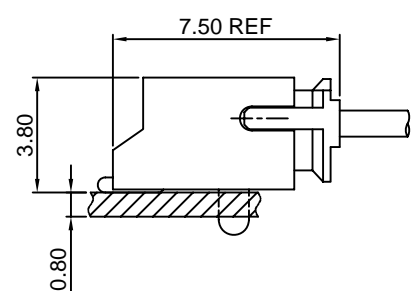

# A1501-T

1.50mm pitch Crimp Terminal

**Reference Informations:**

\*Used in CJT A1501 series Housing

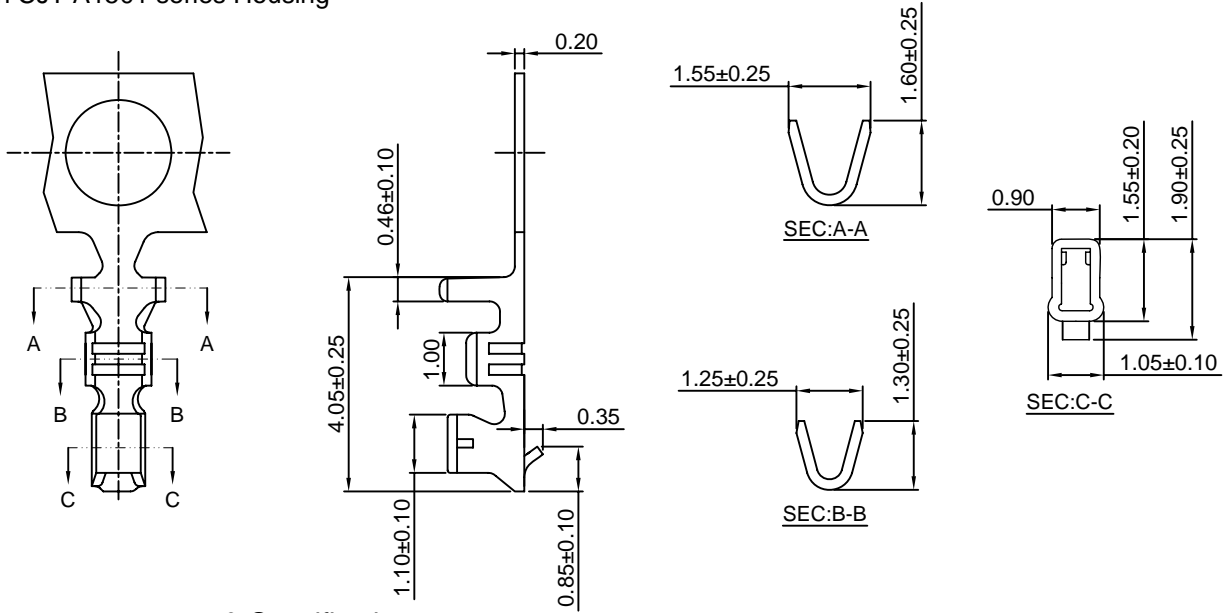

Ordering information & Specifications:

Unit:mm

Part NO.	Wire Range	Insulation O.D.	Material	Finish	Qty/reel
A1501-TP	AWG#26-#32	1.10mm(max)	Phosphor Bronze	Tin over Nickel	10,000 PCS
A1501-GP	AWG#26-#32	1.10mm(max)	Phosphor Bronze	Gold over Nickel	10,000 PCS

Optional Gold plating available but MOQ requested

# A1501-T-H

1.50mm pitch Crimp Terminal

**Reference Informations:**

\*Used in CJT A1501 series Housing

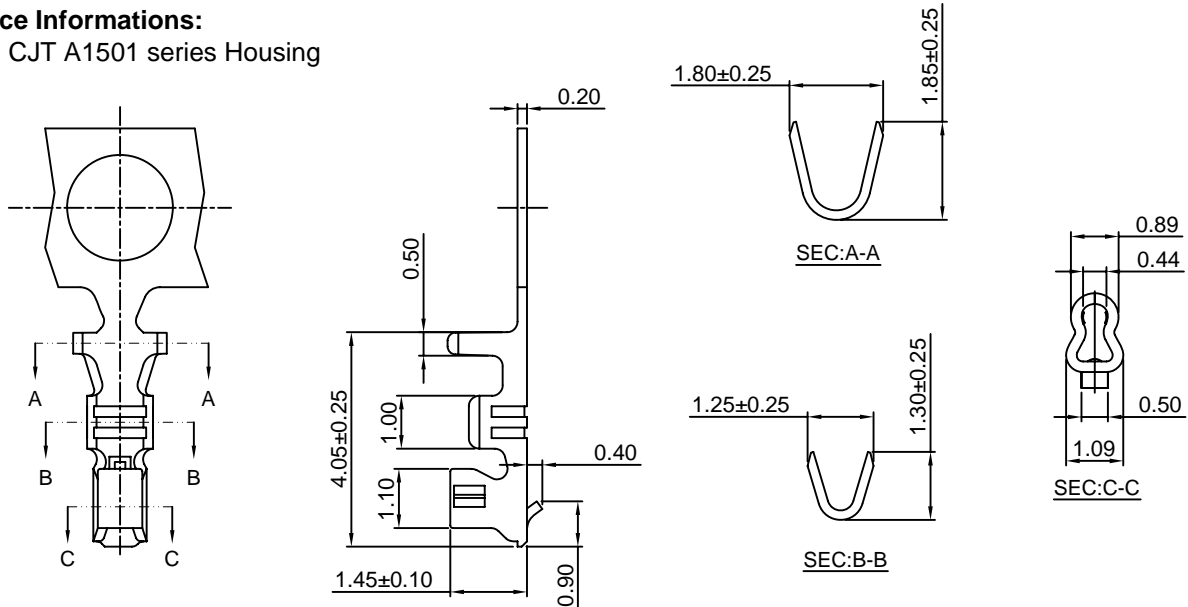

Ordering information & Specifications

Unit:mm

Part NO.	Wire Range	Insulation O.D.	Material	Finish	Qty/reel
A1501-TP-H	AWG#24-#30	1.50mm(max)	Phosphor Bronze	Tin over Nickel	15,000 PCS
A1501-GP-H	AWG#24-#30	1.50mm(max)	Phosphor Bronze	Gold over Nickel	15,000 PCS

Optional Gold plating available but MOQ requested

### A1501M-T

1.50mm pitch Crimp Terminal

#### Reference Informations:

\*Used in CJT A1501HM series Housing

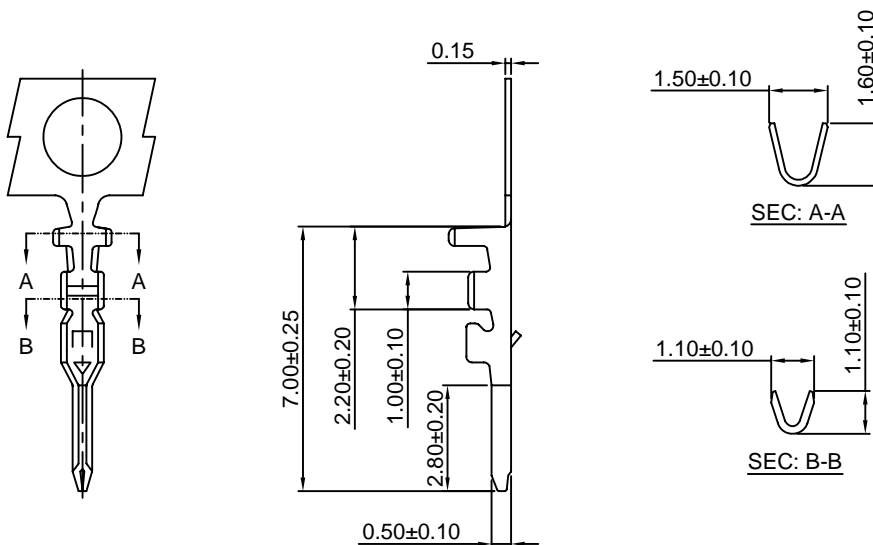

#### Ordering information & Specifications:

Unit:mm

Part NO.	Wire Range	Insulation O.D.	Material	Finish	Qty/reel
A1501M-TP	AWG#28-#32	0.90mm(max)	Phosphor Bronze	Tin over Nickel	15,000 PCS
A1501M-GP	AWG#28-#32	0.90mm(max)	Phosphor Bronze	Gold over Nickel	15,000 PCS

Optional Gold plating available but MOQ requested

### A1501H

1.50mm pitch Housing

#### Reference Informations:

\*Material:Nylon 66,UL94V-0

\*Suitable CJT A1501 series Terminal

\*Mates with CJT A1501 series Wafer and CJT A1501HM series Housing

\*Color:White

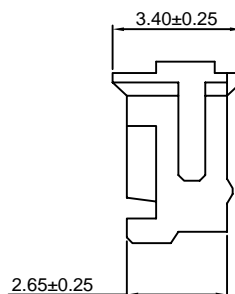
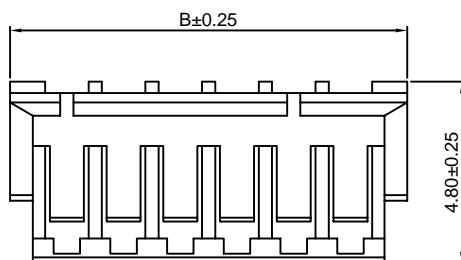
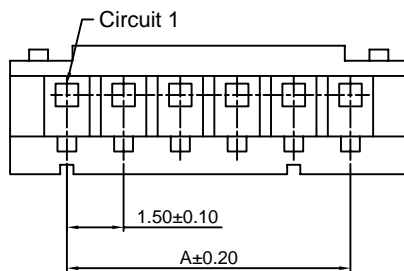
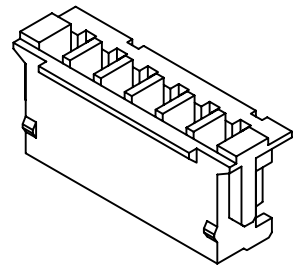

#### Ordering Information & Dimensions:

PART NO.	Dimensions	
	A	B
A1501H-2P	1.50	4.50
A1501H-3P	3.00	6.00
A1501H-4P	4.50	7.50
A1501H-5P	6.00	9.00
A1501H-6P	7.50	10.50
A1501H-7P	9.00	12.00
A1501H-8P	10.50	13.50
A1501H-9P	12.00	15.00
A1501H-10P	13.50	16.50
A1501H-11P	15.00	18.00
A1501H-12P	16.50	19.50
A1501H-13P	18.00	21.00
A1501H-15P	21.00	24.00

Unit: mm

# A1501HM

1.50mm pitch Housing

**Reference Informations:**

- \*Material:Nylon 66,UL94V-0
- \*Suitable CJT A1501M series Terminal
- \*Mates with CJT A1501 series Housing
- \*Color:White

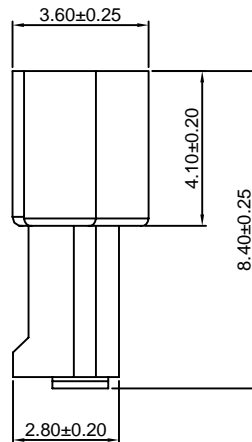
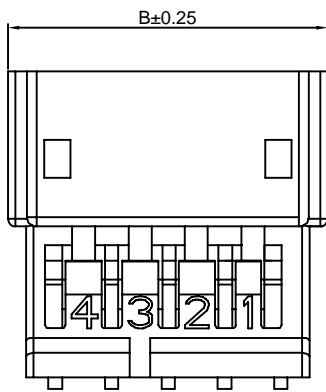
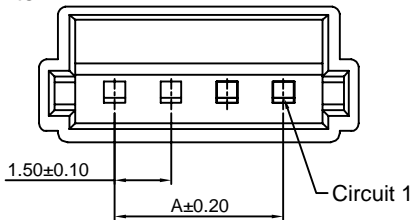

**Ordering Information & Dimensions:**

PART NO.	Dimensions	
	A	B
A1501HM-2P	1.50	5.55
A1501HM-3P	3.00	7.05
A1501HM-4P	4.50	8.55
A1501HM-5P	6.00	10.05
A1501HM-6P	7.50	11.55
A1501HM-7P	9.00	13.05
A1501HM-8P	10.50	14.55
A1501HM-9P	12.00	16.05
A1501HM-10P	13.50	17.55
A1501HM-11P	15.00	19.05
A1501HM-12P	16.50	20.55
A1501HM-13P	18.00	22.05

Unit: mm

# A1501WV

1.50mm pitch 180° Wafer

**Reference Informations:**

- \*Material:Pin:Brass/Tin over Nickel  
Insulator:Nylon 66,UL94V-0
- \*Mates with CJT A1501 series Housing
- \*Color:Brown

**Ordering Information:**

A1501WV-XP - \*\*  
1 2

- 1.Part No.
- 2.Color:  
(blank):Brown  
WH:White

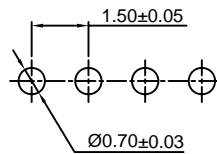
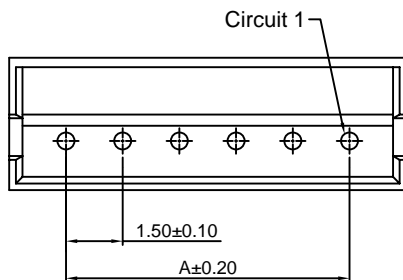

P.C.B LAYOUT

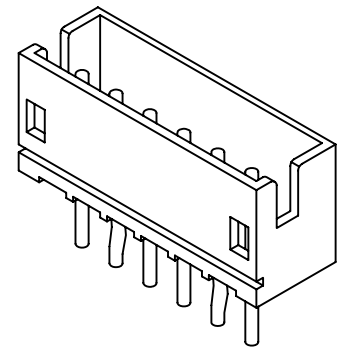
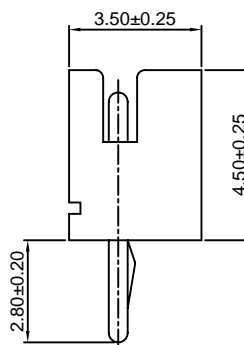
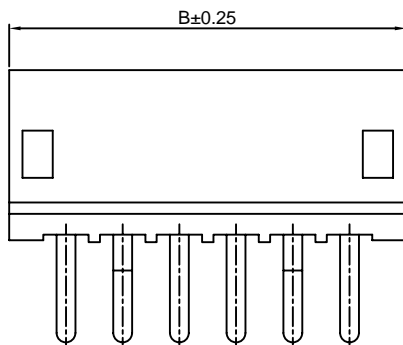

**Ordering Information & Dimensions:**

PART NO.	Dimensions	
	A	B
A1501WV-2P	1.50	4.50
A1501WV-3P	3.00	6.00
A1501WV-4P	4.50	7.50
A1501WV-5P	6.00	9.00
A1501WV-6P	7.50	10.50
A1501WV-7P	9.00	12.00
A1501WV-8P	10.50	13.50
A1501WV-9P	12.00	15.00
A1501WV-10P	13.50	16.50
A1501WV-11P	15.00	18.00
A1501WV-12P	16.50	19.50
A1501WV-13P	18.00	21.00
A1501WV-15P	21.00	24.00

Unit: mm

### A1501WR

1.50mm pitch 90° Wafer

#### Reference Informations:

- \*Material: Pin: Brass/Tin over Nickel  
Insulator: Nylon 66, UL94V-0
- \*Mates with CJT A1501 series Housing
- \*Color: Brown

#### Ordering Information:

- A1501WR-XP - \*\*  
1 2
1. Part No.
  2. Color:  
(blank): Brown  
WH: White

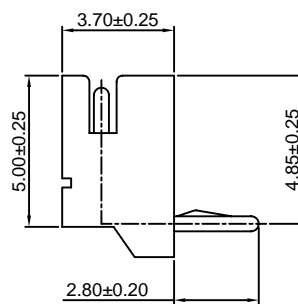
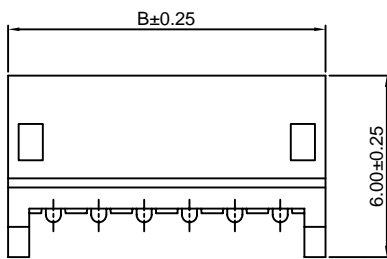
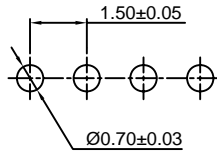
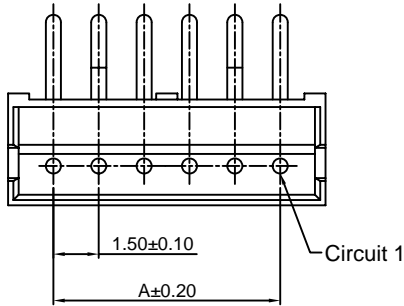
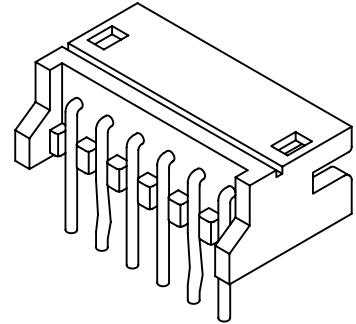

#### Ordering Information & Dimensions:

PART NO.	Dimensions	
	A	B
A1501WR-2P	1.50	4.50
A1501WR-3P	3.00	6.00
A1501WR-4P	4.50	7.50
A1501WR-5P	6.00	9.00
A1501WR-6P	7.50	10.50
A1501WR-7P	9.00	12.00
A1501WR-8P	10.50	13.50
A1501WR-9P	12.00	15.00
A1501WR-10P	13.50	16.50
A1501WR-11P	15.00	18.00
A1501WR-12P	16.50	19.50
A1501WR-13P	18.00	21.00
A1501WR-15P	21.00	24.00

Unit: mm

### A1501WV-S

1.50mm pitch 180° Wafer-SMT TYPE

#### Reference Informations:

- \*Material: Pin: Brass/Tin over Nickel  
Solder Tabs: Brass/Gold over Nickel  
Insulator: Nylon 6T, UL94V-0  
Cap: Nylon 6T, UL94V-0
- \*Mates with CJT A1501 series Housing
- \*Color: Ivory

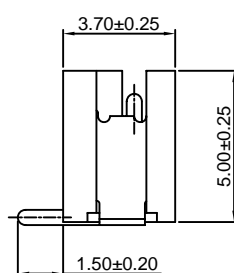
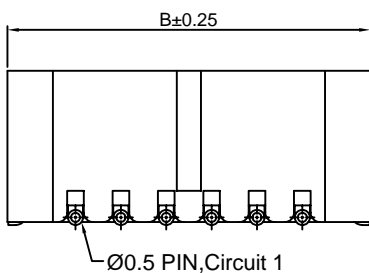
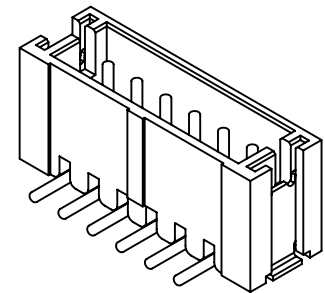
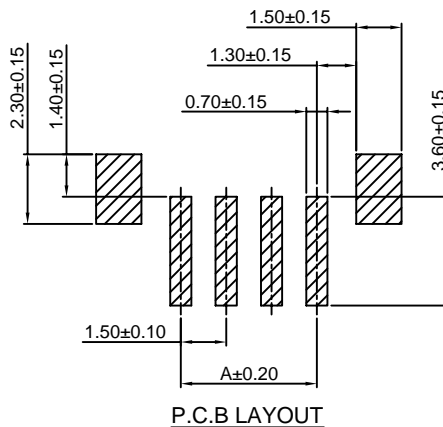
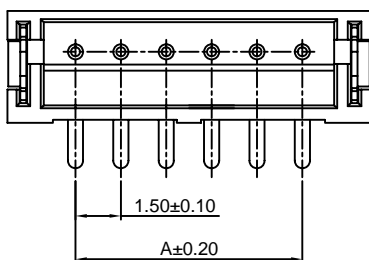

#### Ordering Information & Dimensions:

PART NO.	Dimensions	
	A	B
A1501WV-S-2P	1.50	6.00
A1501WV-S-3P	3.00	7.50
A1501WV-S-4P	4.50	9.00
A1501WV-S-5P	6.00	10.50
A1501WV-S-6P	7.50	12.00
A1501WV-S-7P	9.00	13.50
A1501WV-S-8P	10.50	15.00
A1501WV-S-9P	12.00	16.50
A1501WV-S-10P	13.50	18.00
A1501WV-S-11P	15.00	19.50
A1501WV-S-12P	16.50	21.00
A1501WV-S-13P	18.00	22.50

Unit: mm

## A1501WR-S

1.50mm pitch 90° Wafer-SMT TYPE

### Reference Informations:

- \*Material:Pin:Brass/Tin over Nickel  
Solder Tabs:Brass/Gold over Nickel  
Insulator:Nylon 6T,UL94V-0
- \*Mates with CJT A1501 series Housing
- \*Color:Ivory

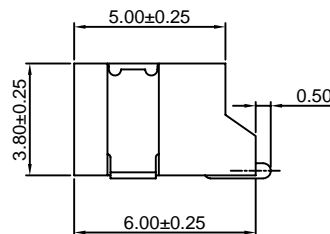
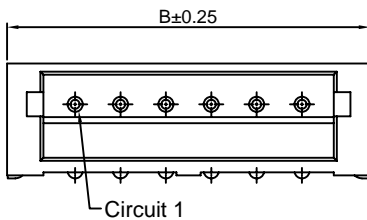
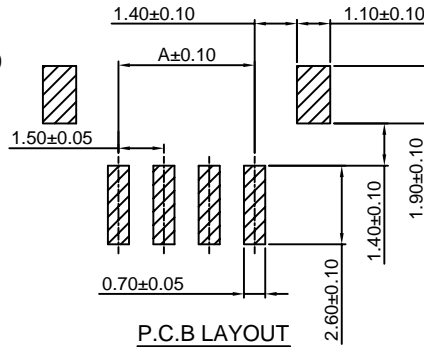
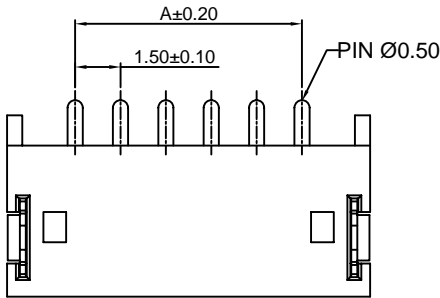
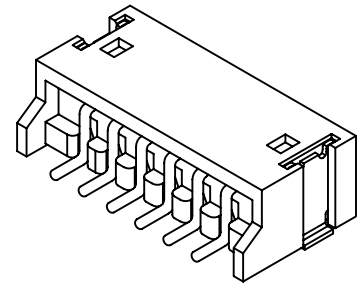

### Ordering Information & Dimensions:

PART NO.	Dimensions	
	A	B
A1501WR-S-2P	1.50	6.00
A1501WR-S-3P	3.00	7.50
A1501WR-S-4P	4.50	9.00
A1501WR-S-5P	6.00	10.50
A1501WR-S-6P	7.50	12.00
A1501WR-S-7P	9.00	13.50
A1501WR-S-8P	10.50	15.00
A1501WR-S-9P	12.00	16.50
A1501WR-S-10P	13.50	18.00
A1501WR-S-11P	15.00	19.50
A1501WR-S-12P	16.50	21.00
A1501WR-S-13P	18.00	22.50

## A1501WR-S-A

1.50mm pitch 90° Wafer DIP TYPE

### Reference Informations:

- \*Material:Pin:Brass/Tin over Nickel  
Solder Tabs:Brass/Gold over Nickel  
Insulator:Nylon 6T,UL94V-0
- \*Mates with CJT A1501 series Housing
- \*Color:Ivory

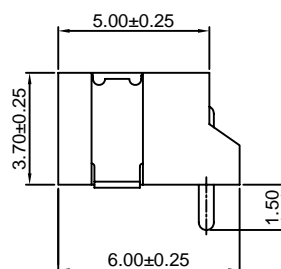
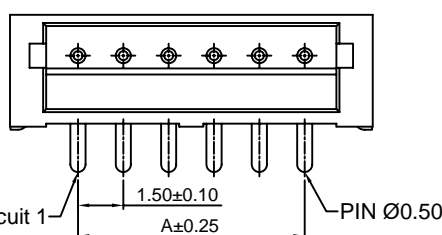
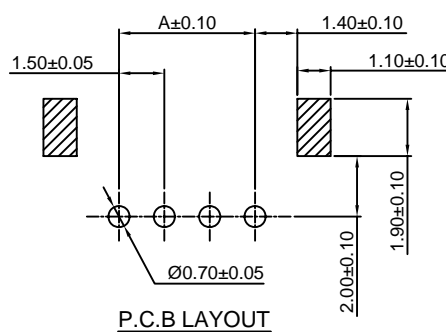
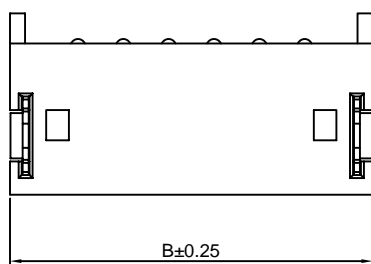
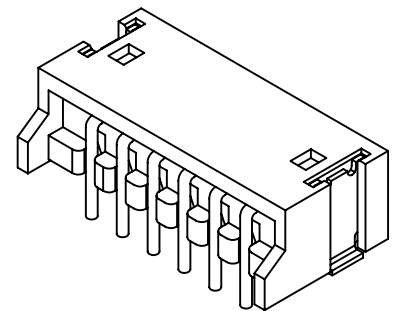

### Ordering Information & Dimensions:

PART NO.	Dimensions	
	A	B
A1501WR-S-2P-A	1.50	6.00
A1501WR-S-3P-A	3.00	7.50
A1501WR-S-4P-A	4.50	9.00
A1501WR-S-5P-A	6.00	10.50
A1501WR-S-6P-A	7.50	12.00
A1501WR-S-7P-A	9.00	13.50
A1501WR-S-8P-A	10.50	15.00
A1501WR-S-9P-A	12.00	16.50
A1501WR-S-10P-A	13.50	18.00
A1501WR-S-11P-A	15.00	19.50
A1501WR-S-12P-A	16.50	21.00
A1501WR-S-13P-A	18.00	22.50

Unit: mm

# A1501WVB-S

1.50mm pitch 180° Wafer-SMT TYPE

**Reference Informations:**

- \*Material:Pin:Phosphor Bronze/Tin over Nickel  
Insulator:LCP,UL94V-0
- \*Mates with CJT A1501 series Housing
- \*Color:Beige

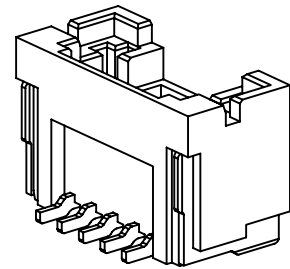
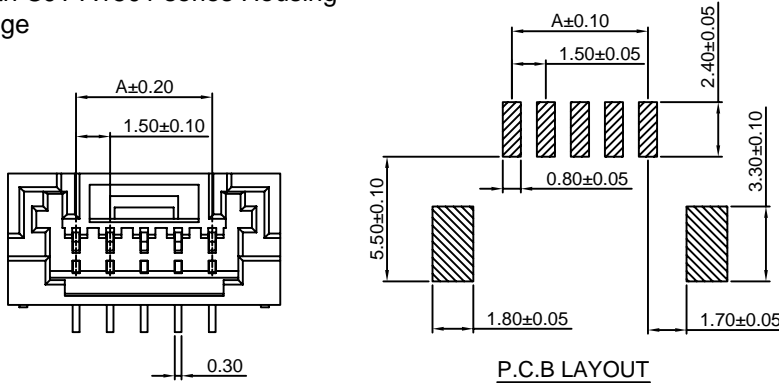
**Ordering Information & Dimensions:**

PART NO.	Dimensions	
	A	B
A1501WVB-S-2P	1.50	7.50
A1501WVB-S-3P	3.00	9.00
A1501WVB-S-4P	4.50	10.50
A1501WVB-S-5P	6.00	12.00
A1501WVB-S-6P	7.50	13.50
A1501WVB-S-7P	9.00	15.00
A1501WVB-S-8P	10.50	16.50
A1501WVB-S-9P	12.00	18.00
A1501WVB-S-10P	13.50	19.50
A1501WVB-S-11P	15.00	21.00
A1501WVB-S-12P	16.50	22.50
A1501WVB-S-13P	18.00	24.00
A1501WVB-S-14P	19.50	25.50
A1501WVB-S-15P	21.00	27.00
A1501WVB-S-16P	22.50	28.50

Unit: mm

# A1501WRB-S

1.50mm pitch 90° Wafer-SMT TYPE

**Reference Informations:**

- \*Material:Pin:Phosphor Bronze/Tin over Nickel  
Insulator:LCP,UL94V-0
- \*Mates with CJT A1501 series Housing
- \*Color:Beige

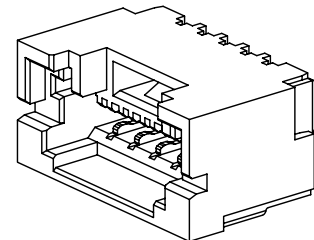
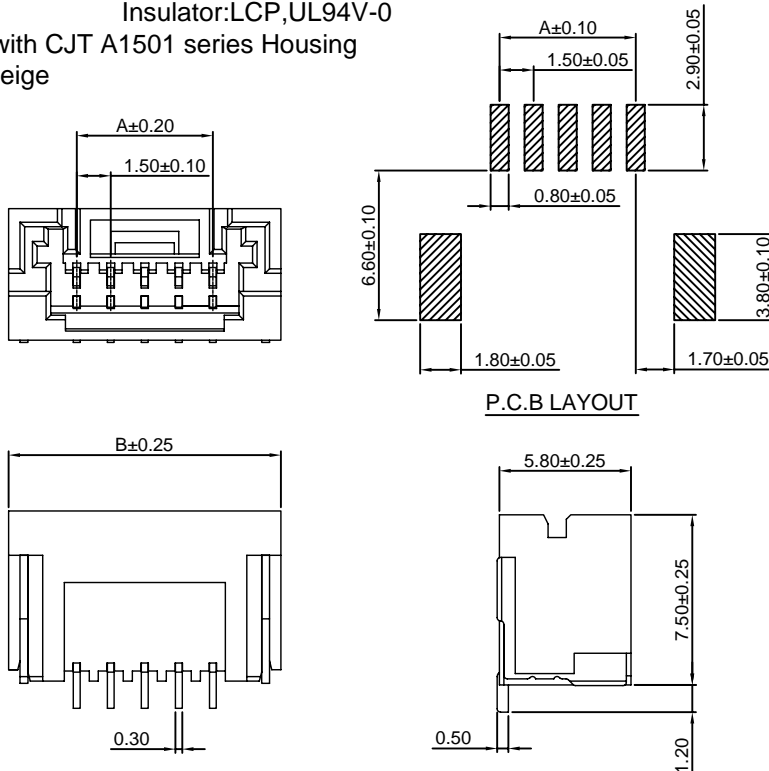
**Ordering Information & Dimensions:**

PART NO.	Dimensions	
	A	B
A1501WRB-S-2P	1.50	7.50
A1501WRB-S-3P	3.00	9.00
A1501WRB-S-4P	4.50	10.50
A1501WRB-S-5P	6.00	12.00
A1501WRB-S-6P	7.50	13.50
A1501WRB-S-7P	9.00	15.00
A1501WRB-S-8P	10.50	16.50
A1501WRB-S-9P	12.00	18.00
A1501WRB-S-10P	13.50	19.50
A1501WRB-S-11P	15.00	21.00
A1501WRB-S-12P	16.50	22.50
A1501WRB-S-13P	18.00	24.00
A1501WRB-S-14P	19.50	25.50
A1501WRB-S-15P	21.00	27.00
A1501WRB-S-16P	22.50	28.50

Unit: mm

## X-ON Electronics

Largest Supplier of Electrical and Electronic Components

*Click to view similar products for [Headers & Wire Housings](#) category:*

*Click to view products by [Changjiang](#) manufacturer:*

Other Similar products are found below :

[57102-F02-18ULF](#) [58102-G61-06LF](#) [0009485154](#) [009176003701906](#) [0050291907](#) [02.125.8002.8](#) [609-3404](#) [61062-3](#) [622-0430](#) [622-3653LF](#)  
[63453-116](#) [636-1030](#) [636-1427](#) [636-3427](#) [636-4007](#) [641938-9](#) [644827-2](#) [65495-038](#) [65692-001LF](#) [65781-018](#) [65781-047](#) [65817-010LF](#)  
[65817-015LF](#) [66207-023LF](#) [67016-026LF](#) [67095-007LF](#) [68631-112](#) [68645-018](#) [68648-049](#) [699319-000](#) [70.362.1628.0](#) [70-4210](#) [70-4226B](#)  
[70-4853B](#) [707-5020](#) [707-5028](#) [71.350.2428.0](#) [71961-016LF](#) [733-134](#) [754199-000](#) [760-3052](#) [787-8014-00](#) [FCN-367T-T012/H](#) [80.063.4001.1](#)  
[800-90-001-10-001000](#) [800-90-010-10-002000](#) [801-43-002-10-013000](#) [801-43-006-10-002000](#) [803-41-018-10-001000](#) [803-43-014-20-](#)  
[001000](#)