

Specifications

- Current rating: 1A AC, DC
- Voltage rating: 100V AC, DC
- Temperature range: -40°C ~ +105°C
- Contact resistance: 20mΩ Max.
- Insulation resistance: 500MΩ Min.
- Withstanding voltage: 500V AC/minute
- *Compliant with RoHS and REACH*
- *Meet the HF/Halogen Free, need to customize*
- *Contact CJT for details*

Standards

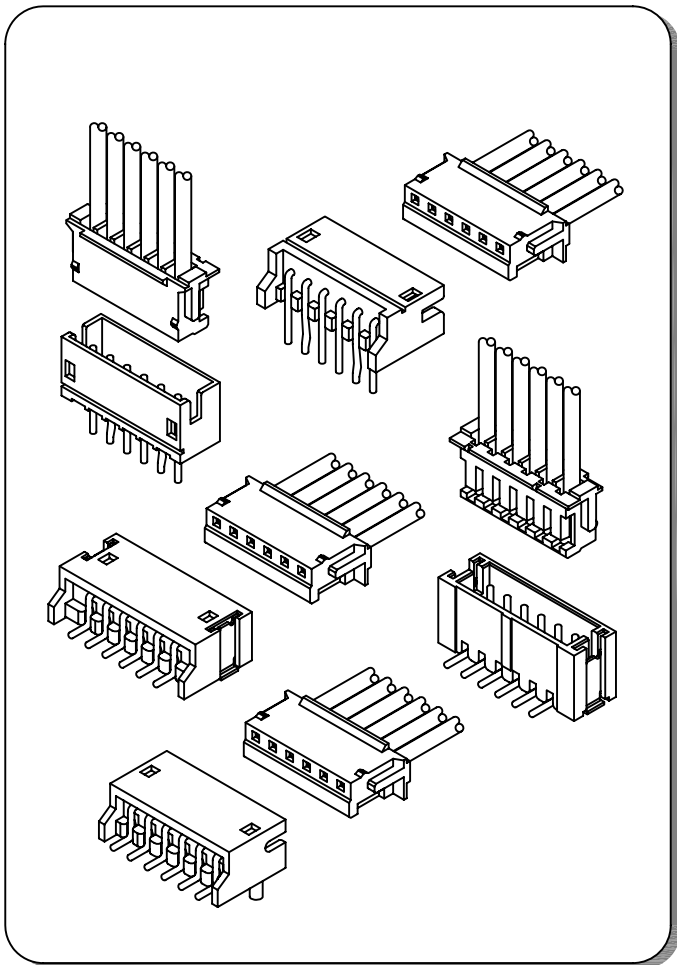

Assembly layout

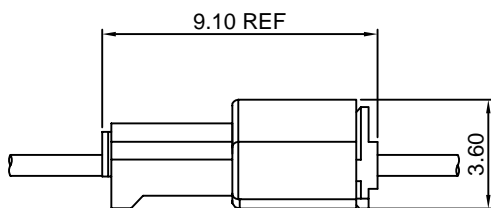

wire to wire

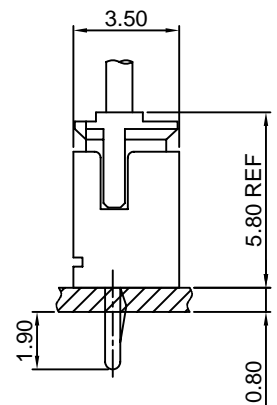
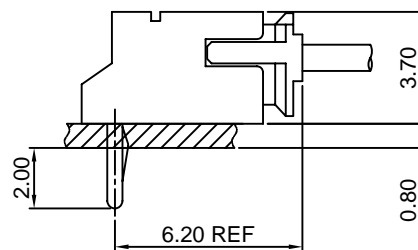

DIP TYPE

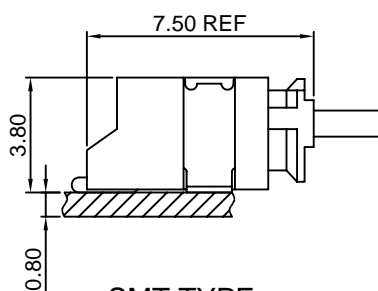
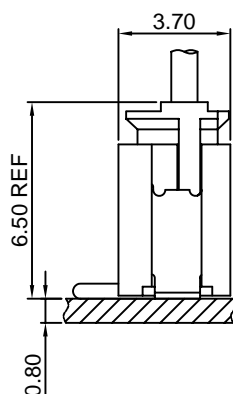

SMT TYPE

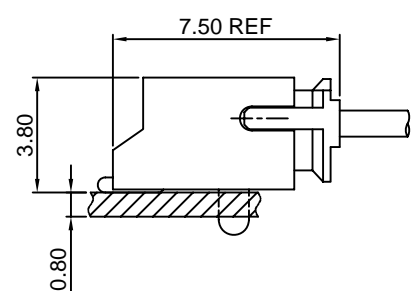

A1501-T

1.50mm pitch Crimp Terminal

Reference Informations:

*Used in CJT A1501 series Housing

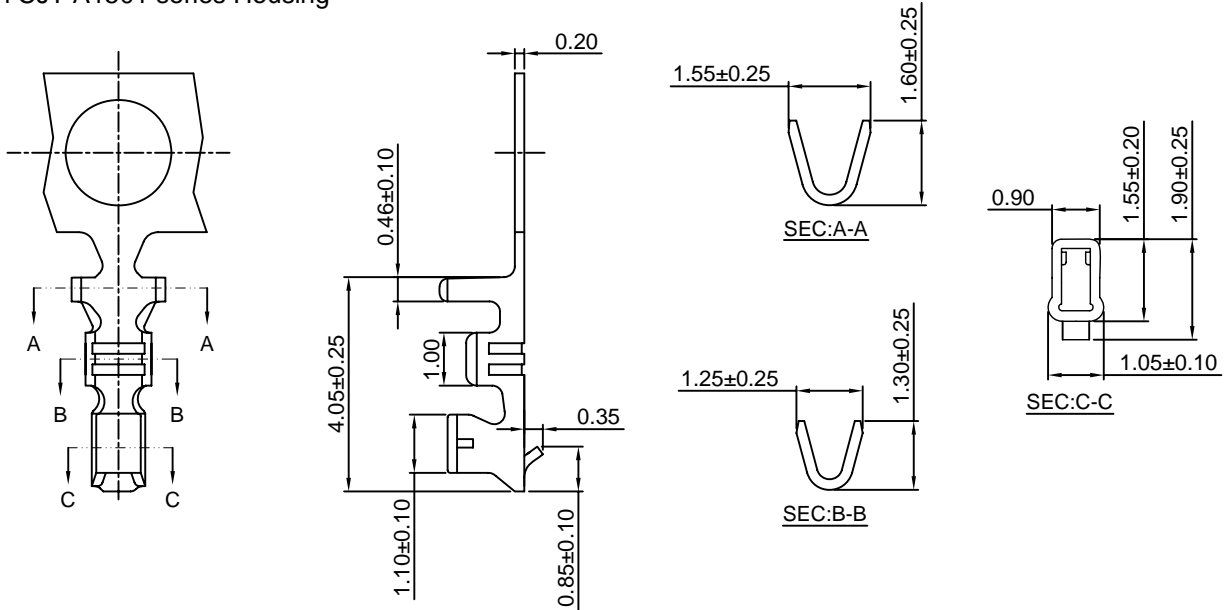

Ordering information & Specifications:

Unit:mm

Part NO.	Wire Range	Insulation O.D.	Material	Finish	Qty/reel
A1501-TP	AWG#26-#32	1.10mm(max)	Phosphor Bronze	Tin over Nickel	10,000 PCS
A1501-GP	AWG#26-#32	1.10mm(max)	Phosphor Bronze	Gold over Nickel	10,000 PCS

Optional Gold plating available but MOQ requested

A1501-T-H

1.50mm pitch Crimp Terminal

Reference Informations:

*Used in CJT A1501 series Housing

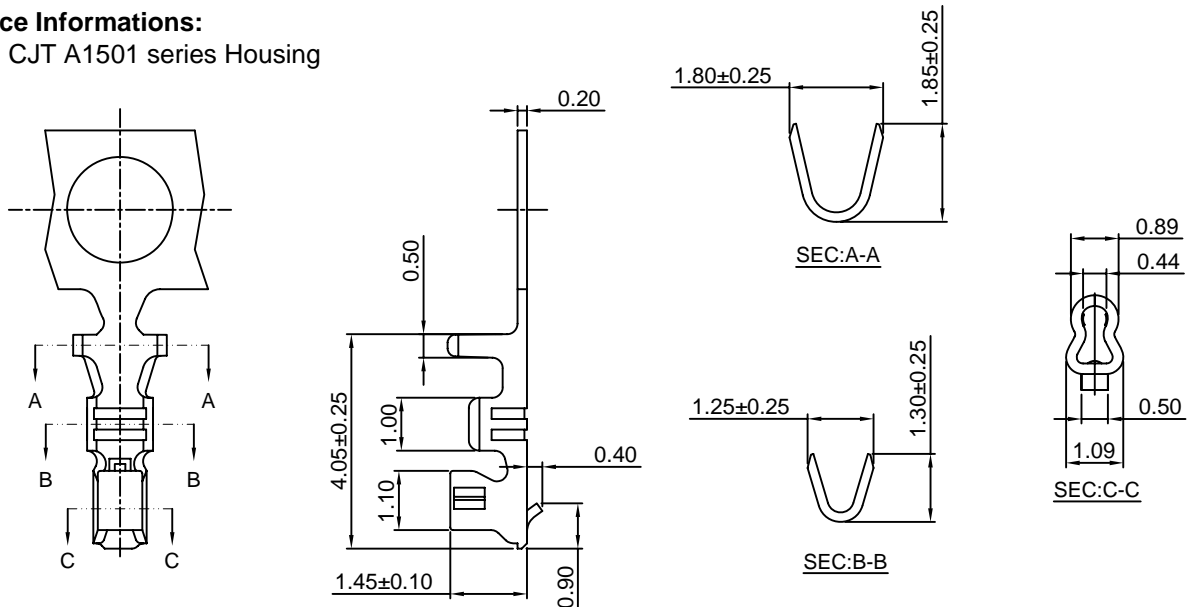

Ordering information & Specifications

Unit:mm

Part NO.	Wire Range	Insulation O.D.	Material	Finish	Qty/reel
A1501-TP-H	AWG#24-#30	1.50mm(max)	Phosphor Bronze	Tin over Nickel	15,000 PCS
A1501-GP-H	AWG#24-#30	1.50mm(max)	Phosphor Bronze	Gold over Nickel	15,000 PCS

Optional Gold plating available but MOQ requested

A1501M-T

1.50mm pitch Crimp Terminal

Reference Informations:

*Used in CJT A1501HM series Housing

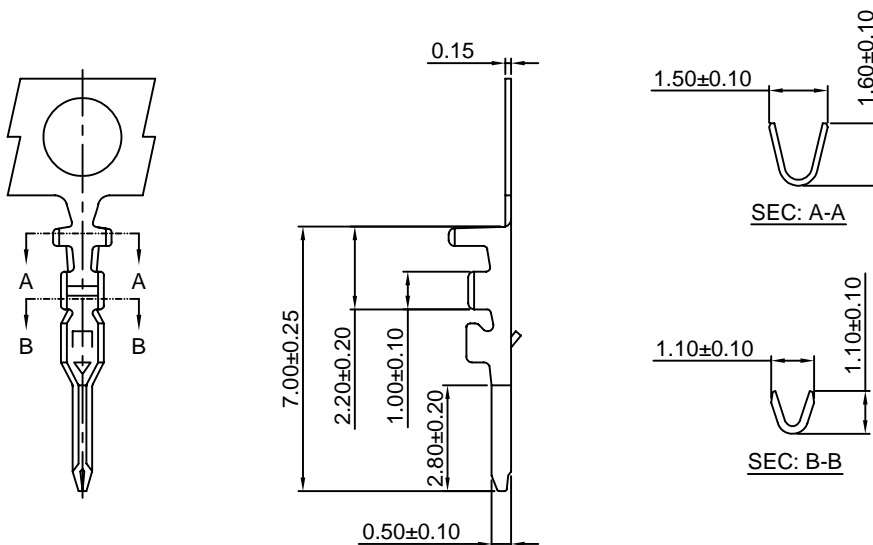

Ordering information & Specifications:

Unit:mm

Part NO.	Wire Range	Insulation O.D.	Material	Finish	Qty/reel
A1501M-TP	AWG#28-#32	0.90mm(max)	Phosphor Bronze	Tin over Nickel	15,000 PCS
A1501M-GP	AWG#28-#32	0.90mm(max)	Phosphor Bronze	Gold over Nickel	15,000 PCS

Optional Gold plating available but MOQ requested

A1501H

1.50mm pitch Housing

Reference Informations:

*Material:Nylon 66,UL94V-0

*Suitable CJT A1501 series Terminal

*Mates with CJT A1501 series Wafer and CJT A1501HM series Housing

*Color:White

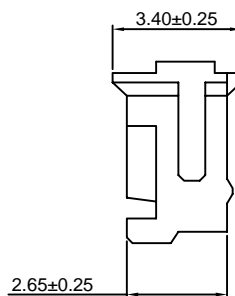
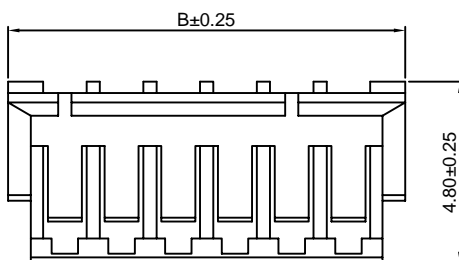
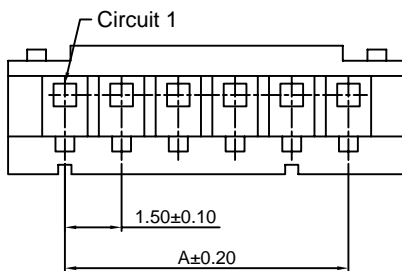
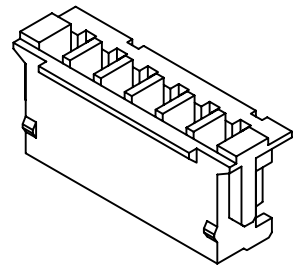

Ordering Information & Dimensions:

PART NO.	Dimensions	
	A	B
A1501H-2P	1.50	4.50
A1501H-3P	3.00	6.00
A1501H-4P	4.50	7.50
A1501H-5P	6.00	9.00
A1501H-6P	7.50	10.50
A1501H-7P	9.00	12.00
A1501H-8P	10.50	13.50
A1501H-9P	12.00	15.00
A1501H-10P	13.50	16.50
A1501H-11P	15.00	18.00
A1501H-12P	16.50	19.50
A1501H-13P	18.00	21.00
A1501H-15P	21.00	24.00

Unit: mm

A1501HM

1.50mm pitch Housing

Reference Informations:

- *Material:Nylon 66,UL94V-0
- *Suitable CJT A1501M series Terminal
- *Mates with CJT A1501 series Housing
- *Color:White

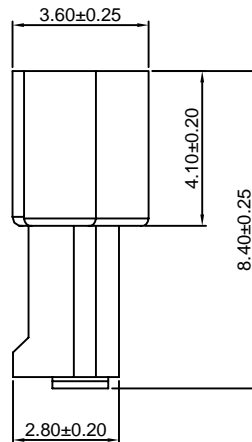
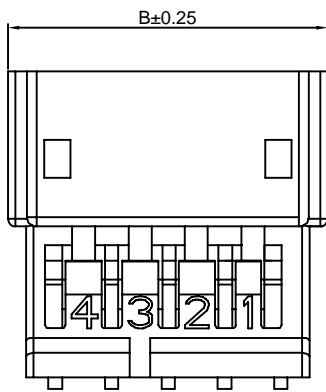
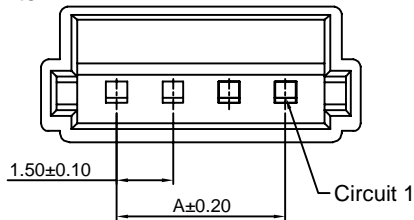

Ordering Information & Dimensions:

PART NO.	Dimensions	
	A	B
A1501HM-2P	1.50	5.55
A1501HM-3P	3.00	7.05
A1501HM-4P	4.50	8.55
A1501HM-5P	6.00	10.05
A1501HM-6P	7.50	11.55
A1501HM-7P	9.00	13.05
A1501HM-8P	10.50	14.55
A1501HM-9P	12.00	16.05
A1501HM-10P	13.50	17.55
A1501HM-11P	15.00	19.05
A1501HM-12P	16.50	20.55
A1501HM-13P	18.00	22.05

Unit: mm

A1501WV

1.50mm pitch 180° Wafer

Reference Informations:

- *Material:Pin:Brass/Tin over Nickel
Insulator:Nylon 66,UL94V-0
- *Mates with CJT A1501 series Housing
- *Color:Brown

Ordering Information:

A1501WV-XP - **
1 2

- 1.Part No.
- 2.Color:
(blank):Brown
WH:White

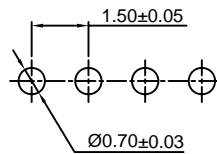
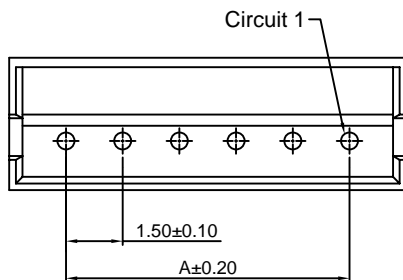

P.C.B LAYOUT

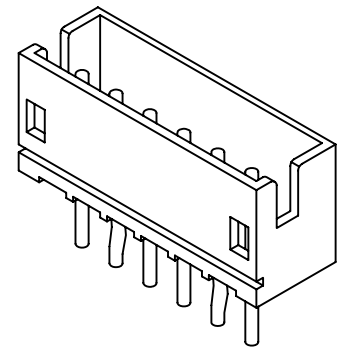
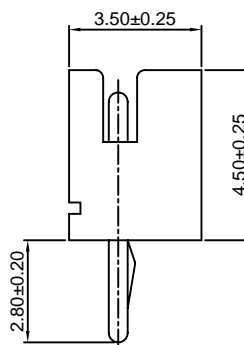
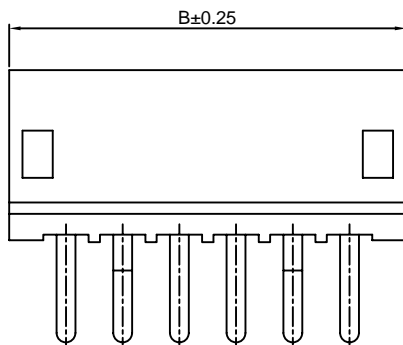

Ordering Information & Dimensions:

PART NO.	Dimensions	
	A	B
A1501WV-2P	1.50	4.50
A1501WV-3P	3.00	6.00
A1501WV-4P	4.50	7.50
A1501WV-5P	6.00	9.00
A1501WV-6P	7.50	10.50
A1501WV-7P	9.00	12.00
A1501WV-8P	10.50	13.50
A1501WV-9P	12.00	15.00
A1501WV-10P	13.50	16.50
A1501WV-11P	15.00	18.00
A1501WV-12P	16.50	19.50
A1501WV-13P	18.00	21.00
A1501WV-15P	21.00	24.00

Unit: mm

A1501WR

1.50mm pitch 90° Wafer

Reference Informations:

- *Material: Pin: Brass/Tin over Nickel
Insulator: Nylon 66, UL94V-0
- *Mates with CJT A1501 series Housing
- *Color: Brown

Ordering Information:

- A1501WR-XP - **
- 1 2
1. Part No.
 2. Color:
(blank): Brown
WH: White

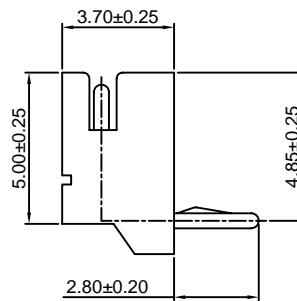
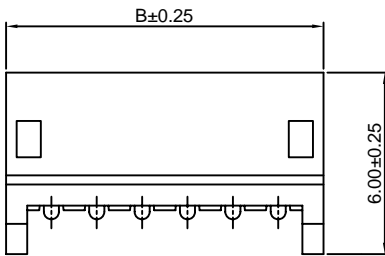
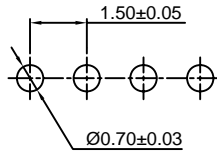
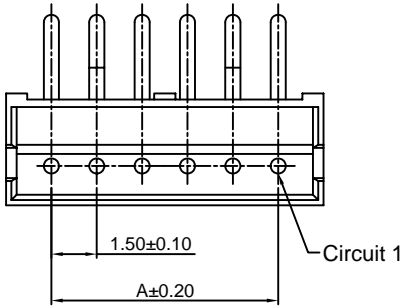
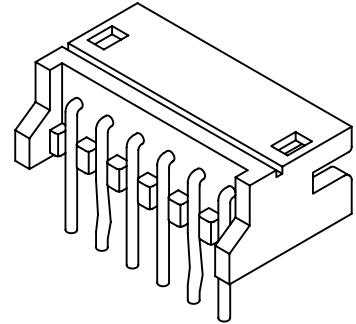

Ordering Information & Dimensions:

PART NO.	Dimensions	
	A	B
A1501WR-2P	1.50	4.50
A1501WR-3P	3.00	6.00
A1501WR-4P	4.50	7.50
A1501WR-5P	6.00	9.00
A1501WR-6P	7.50	10.50
A1501WR-7P	9.00	12.00
A1501WR-8P	10.50	13.50
A1501WR-9P	12.00	15.00
A1501WR-10P	13.50	16.50
A1501WR-11P	15.00	18.00
A1501WR-12P	16.50	19.50
A1501WR-13P	18.00	21.00
A1501WR-15P	21.00	24.00

Unit: mm

A1501WV-S

1.50mm pitch 180° Wafer-SMT TYPE

Reference Informations:

- *Material: Pin: Brass/Tin over Nickel
Solder Tabs: Brass/Gold over Nickel
Insulator: Nylon 6T, UL94V-0
Cap: Nylon 6T, UL94V-0
- *Mates with CJT A1501 series Housing
- *Color: Ivory

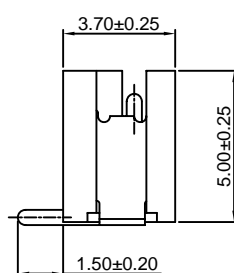
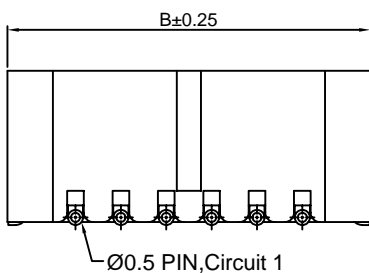
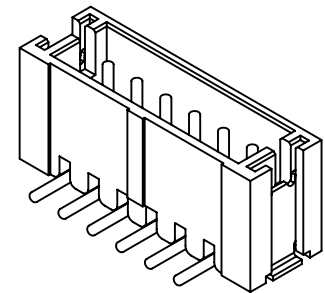
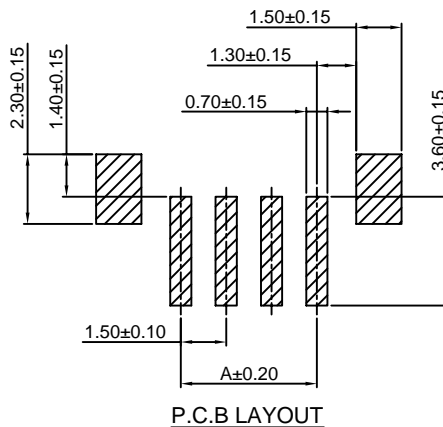
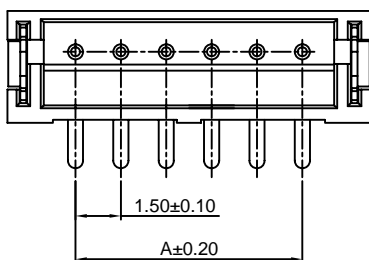

Ordering Information & Dimensions:

PART NO.	Dimensions	
	A	B
A1501WV-S-2P	1.50	6.00
A1501WV-S-3P	3.00	7.50
A1501WV-S-4P	4.50	9.00
A1501WV-S-5P	6.00	10.50
A1501WV-S-6P	7.50	12.00
A1501WV-S-7P	9.00	13.50
A1501WV-S-8P	10.50	15.00
A1501WV-S-9P	12.00	16.50
A1501WV-S-10P	13.50	18.00
A1501WV-S-11P	15.00	19.50
A1501WV-S-12P	16.50	21.00
A1501WV-S-13P	18.00	22.50

Unit: mm

A1501WR-S

1.50mm pitch 90° Wafer-SMT TYPE

Reference Informations:

- *Material:Pin:Brass/Tin over Nickel
Solder Tabs:Brass/Gold over Nickel
Insulator:Nylon 6T,UL94V-0
- *Mates with CJT A1501 series Housing
- *Color:Ivory

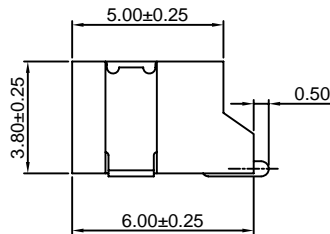
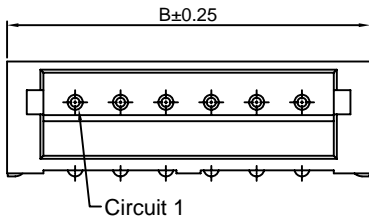
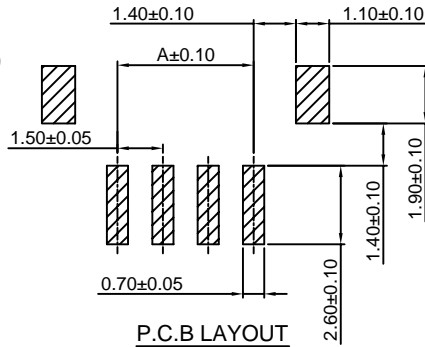
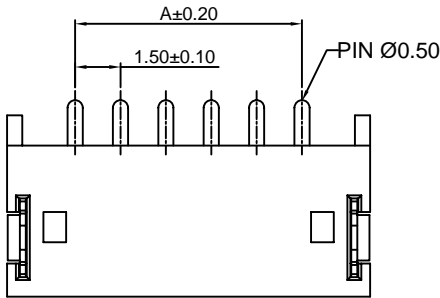
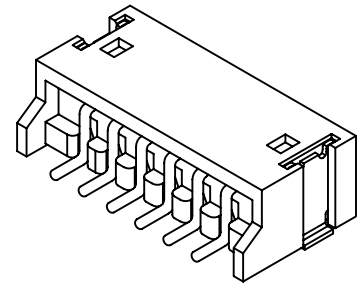

Ordering Information & Dimensions:

PART NO.	Dimensions	
	A	B
A1501WR-S-2P	1.50	6.00
A1501WR-S-3P	3.00	7.50
A1501WR-S-4P	4.50	9.00
A1501WR-S-5P	6.00	10.50
A1501WR-S-6P	7.50	12.00
A1501WR-S-7P	9.00	13.50
A1501WR-S-8P	10.50	15.00
A1501WR-S-9P	12.00	16.50
A1501WR-S-10P	13.50	18.00
A1501WR-S-11P	15.00	19.50
A1501WR-S-12P	16.50	21.00
A1501WR-S-13P	18.00	22.50

A1501WR-S-A

1.50mm pitch 90° Wafer DIP TYPE

Reference Informations:

- *Material:Pin:Brass/Tin over Nickel
Solder Tabs:Brass/Gold over Nickel
Insulator:Nylon 6T,UL94V-0
- *Mates with CJT A1501 series Housing
- *Color:Ivory

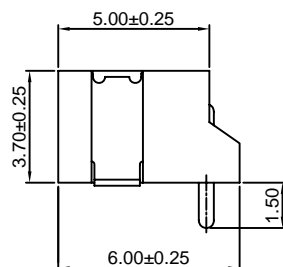
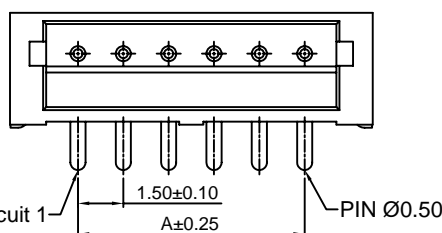
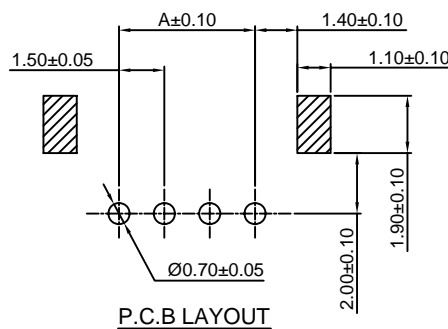
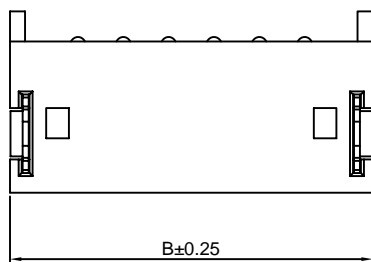
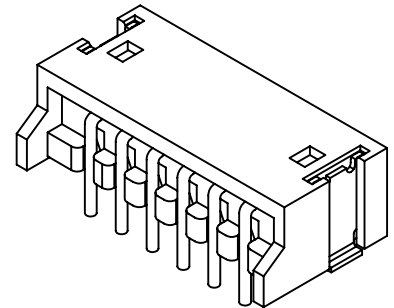

Ordering Information & Dimensions:

PART NO.	Dimensions	
	A	B
A1501WR-S-2P-A	1.50	6.00
A1501WR-S-3P-A	3.00	7.50
A1501WR-S-4P-A	4.50	9.00
A1501WR-S-5P-A	6.00	10.50
A1501WR-S-6P-A	7.50	12.00
A1501WR-S-7P-A	9.00	13.50
A1501WR-S-8P-A	10.50	15.00
A1501WR-S-9P-A	12.00	16.50
A1501WR-S-10P-A	13.50	18.00
A1501WR-S-11P-A	15.00	19.50
A1501WR-S-12P-A	16.50	21.00
A1501WR-S-13P-A	18.00	22.50

Unit: mm

A1501WVB-S

1.50mm pitch 180° Wafer-SMT TYPE

Reference Informations:

- *Material:Pin:Phosphor Bronze/Tin over Nickel
Insulator:LCP,UL94V-0
- *Mates with CJT A1501 series Housing
- *Color:Beige

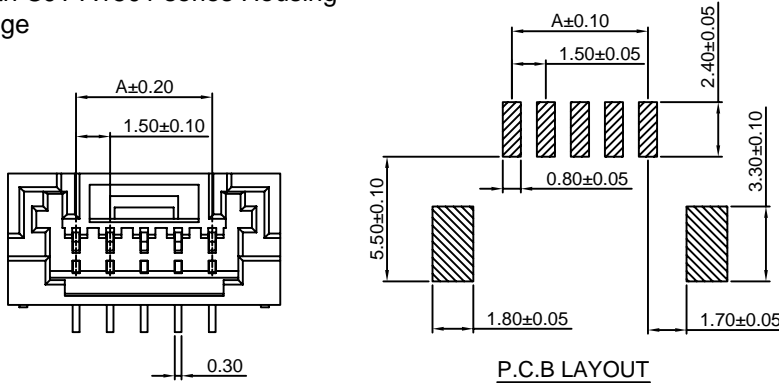

P.C.B LAYOUT

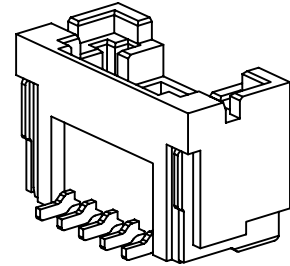
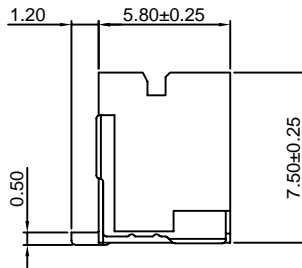
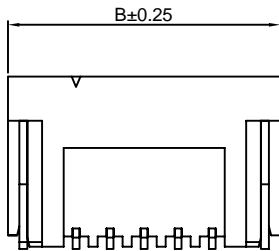
Ordering Information & Dimensions:

PART NO.	Dimensions	
	A	B
A1501WVB-S-2P	1.50	7.50
A1501WVB-S-3P	3.00	9.00
A1501WVB-S-4P	4.50	10.50
A1501WVB-S-5P	6.00	12.00
A1501WVB-S-6P	7.50	13.50
A1501WVB-S-7P	9.00	15.00
A1501WVB-S-8P	10.50	16.50
A1501WVB-S-9P	12.00	18.00
A1501WVB-S-10P	13.50	19.50
A1501WVB-S-11P	15.00	21.00
A1501WVB-S-12P	16.50	22.50
A1501WVB-S-13P	18.00	24.00
A1501WVB-S-14P	19.50	25.50
A1501WVB-S-15P	21.00	27.00
A1501WVB-S-16P	22.50	28.50

Unit: mm

A1501WRB-S

1.50mm pitch 90° Wafer-SMT TYPE

Reference Informations:

- *Material:Pin:Phosphor Bronze/Tin over Nickel
Insulator:LCP,UL94V-0
- *Mates with CJT A1501 series Housing
- *Color:Beige

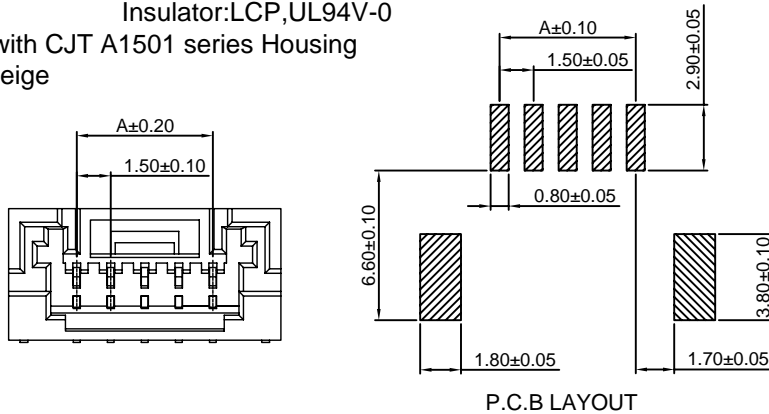

P.C.B LAYOUT

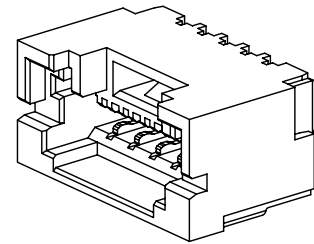
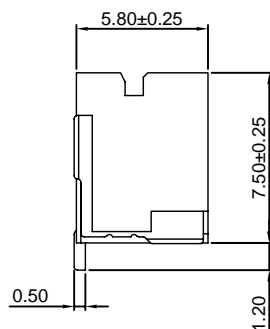
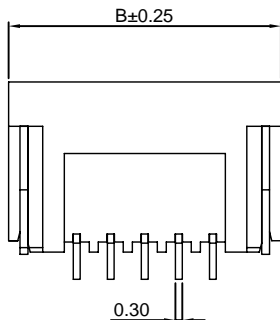
Ordering Information & Dimensions:

PART NO.	Dimensions	
	A	B
A1501WRB-S-2P	1.50	7.50
A1501WRB-S-3P	3.00	9.00
A1501WRB-S-4P	4.50	10.50
A1501WRB-S-5P	6.00	12.00
A1501WRB-S-6P	7.50	13.50
A1501WRB-S-7P	9.00	15.00
A1501WRB-S-8P	10.50	16.50
A1501WRB-S-9P	12.00	18.00
A1501WRB-S-10P	13.50	19.50
A1501WRB-S-11P	15.00	21.00
A1501WRB-S-12P	16.50	22.50
A1501WRB-S-13P	18.00	24.00
A1501WRB-S-14P	19.50	25.50
A1501WRB-S-15P	21.00	27.00
A1501WRB-S-16P	22.50	28.50

Unit: mm

X-ON Electronics

Largest Supplier of Electrical and Electronic Components

Click to view similar products for [Headers & Wire Housings](#) category:

Click to view products by [Changjiang](#) manufacturer:

Other Similar products are found below :

[57102-F02-18ULF](#) [58102-G61-06LF](#) [582553-1](#) [009176003701906](#) [0050291907](#) [02.125.8002.8](#) [609-3404](#) [61062-3](#) [622-0430](#) [622-3653LF](#)
[63453-116](#) [636-1030](#) [636-1427](#) [636-3427](#) [636-4007](#) [641938-9](#) [65495-038](#) [65692-001LF](#) [65781-018](#) [65781-047](#) [65817-010LF](#) [65817-015LF](#)
[66207-023LF](#) [67016-026LF](#) [67095-007LF](#) [68631-112](#) [68645-018](#) [68648-049](#) [699319-000](#) [M90C108951C](#) [70.362.1628.0](#) [70-4210](#) [70-4226B](#)
[70-4853B](#) [707-5020](#) [707-5028](#) [71.350.2428.0](#) [71961-016LF](#) [733-134](#) [754199-000](#) [760-3052](#) [787-8014-00](#) [FCN-367T-T012/H](#)
[80.063.4001.1](#) [800-90-001-10-001000](#) [801-43-002-10-013000](#) [801-43-006-10-002000](#) [803-41-018-10-001000](#) [803-43-014-20-001000](#)
[803-43-024-10-001000](#)