

## Specifications

- Current rating:3A AC,DC
- Voltage rating:350V AC,DC
- Temperature range:-40°C~+105°C
- Contact resistance:20mΩMax.
- Insulation resistance:1000MΩMin.
- Withstanding voltage:500V AC/minute
- \*Compliant with RoHS and REACH\*
- \*Meet the HF/Halogen Free,need to customize\*
- \*Contact CJT for details\*

## Standards



## Assembly layout

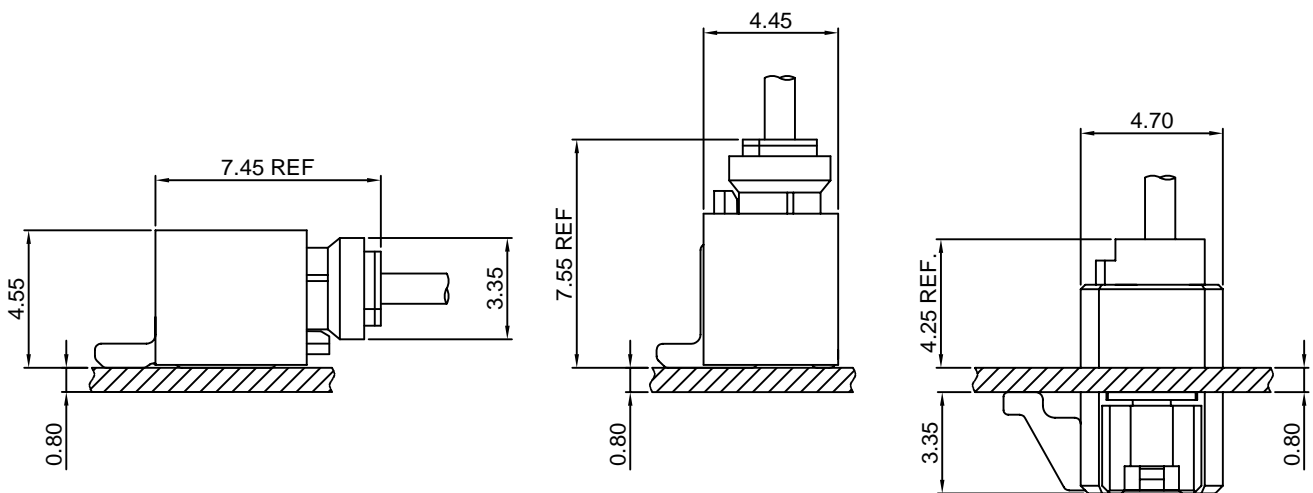

**A1502-T**

1.50mm pitch Crimp Terminal

**Reference Informations:**

\*Used in CJT A1502H-XP series Housing

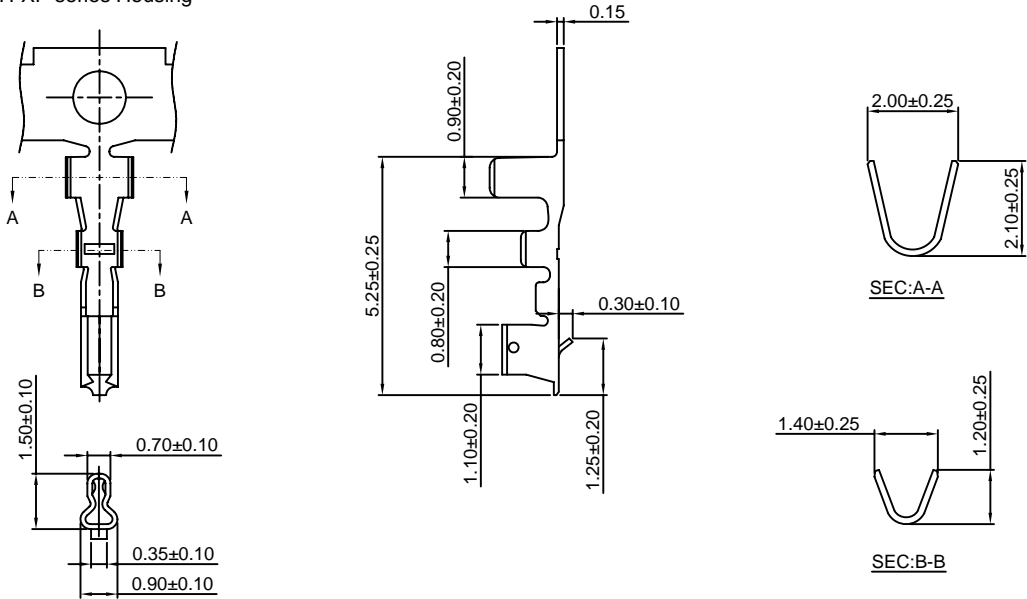

Ordering information & Specifications:

Unit:mm

Part NO.	Wire Range	Insulation O.D.	Material	Finish	Qty/reel
A1502-TP	AWG#24-#28	1.10mm(max)	Phosphor Bronze	Tin over Nickel	10,000 PCS
A1502-GP	AWG#24-#28	1.10mm(max)	Phosphor Bronze	Gold over Nickel	10,000 PCS

Optional Gold plating available but MOQ requested

**A1502-T-A**

1.50mm pitch Crimp Terminal

**Reference Informations:**

\*Used in CJT A1502HA-XP series Housing

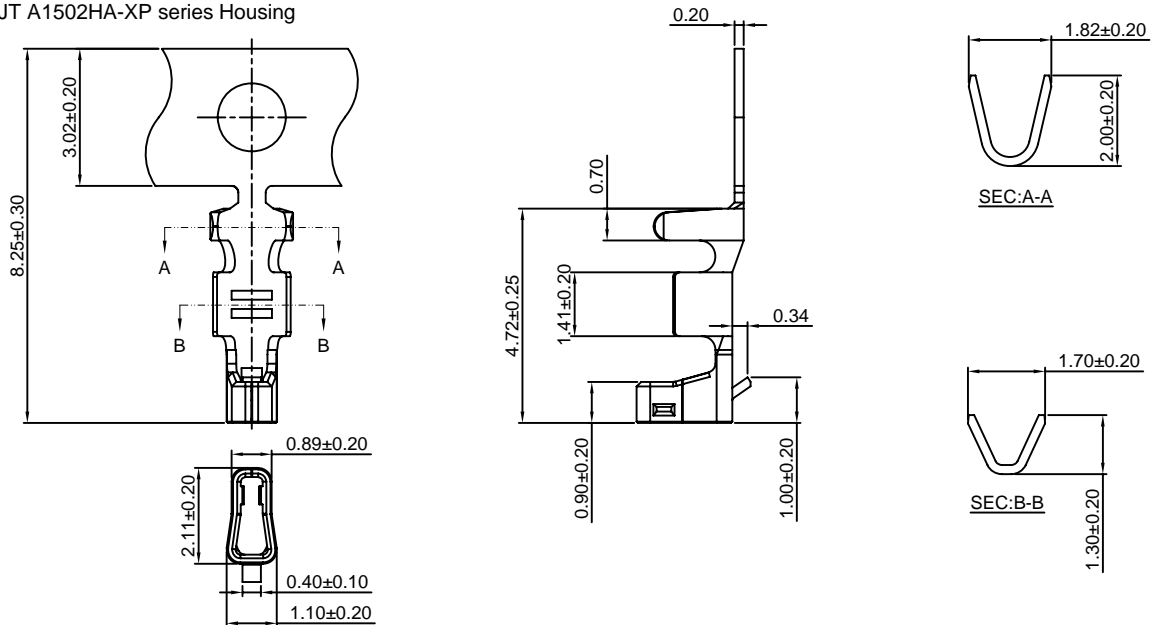

Ordering information & Specifications:

Unit:mm

Part NO.	Wire Range	Insulation O.D.	Material	Finish	Qty/reel
A1502-TP-A	AWG#24-#28	1.10mm(max)	Phosphor Bronze	Tin over Nickel	10,000 PCS
A1502-GP-A	AWG#24-#28	1.10mm(max)	Phosphor Bronze	Gold over Nickel	10,000 PCS

Optional Gold plating available but MOQ requested

### A1502H-XP

1.50mm pitch Housing

#### Reference Informations:

- \*Material:Nylon 66,UL94V-0
- \*Suitable CJT A1502-T series Terminal
- \*Mates with CJT A1502WV,WR,WV-S,WR-S,WVA,WRA-XP series Wafer
- \*Color:White

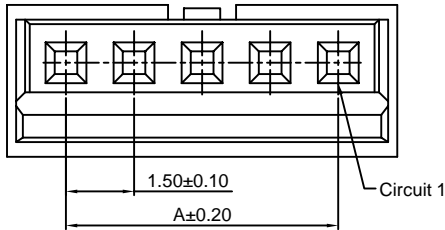

#### Ordering Information:

A1502H-XP - \*\* - \*\*\*  
1 2 3

- 1.Part No.
- 2.Color:  
(blank) : White  
BK : Black
- 3.Material:  
(Blank):Nylon 66,UL94V-0  
GWT :Nylon 66,UL94V-0 GWT 750 °C

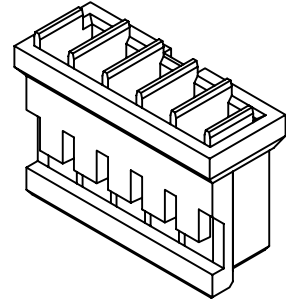

#### Ordering Information & Dimensions:

PART NO.	Dimensions	
	A	B
2P	1.50	4.10
3P	3.00	5.60
4P	4.50	7.10
5P	6.00	8.60
6P	7.50	10.10
7P	9.00	11.60
8P	10.50	13.10
9P	12.00	14.60
10P	13.50	16.10
11P	15.00	17.60
12P	16.50	19.10
13P	18.00	20.60
14P	19.50	22.10
15P	21.00	23.60

Unit: mm

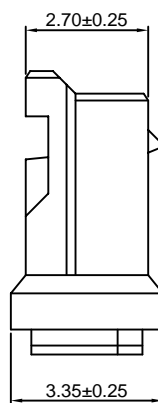
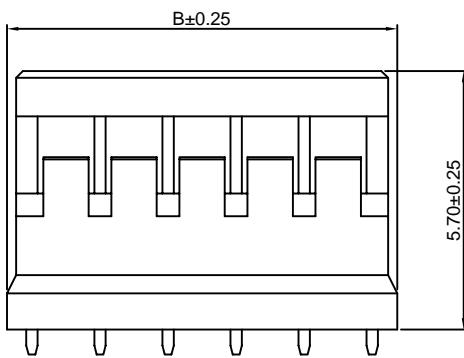

### A1502HA-XP

1.50mm pitch Housing

#### Reference Informations:

- \*Material:Nylon 66,UL94V-0
- \*Suitable CJT A1502-T-A series Terminal
- \*Mates with CJT A1502WVA-IT-S-XP series Wafer
- \*Color:White

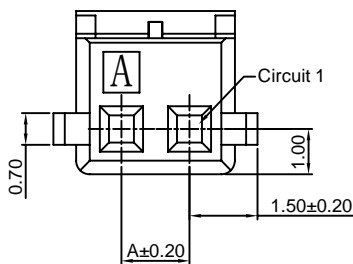

#### Ordering Information:

A1502HA-XP - \*\* - \*\*\*  
1 2 3

- 1.Part No.
- 2.Color:  
(blank) : White  
BL : Blue
- 3.Material:  
(Blank):Nylon 66,UL94V-0  
GWT :Nylon 66,UL94V-0 GWT 750 °C

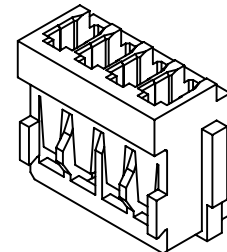

#### Ordering Information & Dimensions:

PART NO.	Dimensions	
	A	B
2P	1.50	3.50
3P	3.00	5.00
4P	4.50	6.50
5P	6.00	8.00
6P	7.50	9.50
7P	9.00	11.00
8P	10.50	12.50
9P	12.00	14.00
10P	13.50	15.50
11P	15.00	17.00
12P	16.50	18.50
13P	18.00	20.00
14P	19.50	21.50
15P	21.00	23.00
16P	22.50	24.50
17P	24.00	26.00
18P	25.50	27.50
19P	27.00	29.00
20P	28.50	30.50

Unit: mm

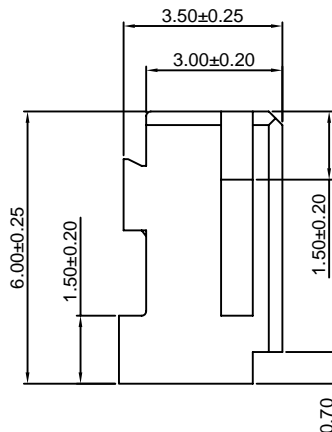
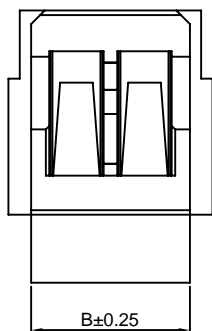

### A1502WV-XP

1.50mm pitch 180° Wafer

**Reference Informations:**

- \*Material:Pin:Brass/Tin over Nickel  
Insulator:Nylon 66,UL94V-0
- \*Mates with CJT A1502H-XP series Housing
- \*Color:White

**Ordering Information:**

- A1502WV-XP - \*\*\* - \*\* - \*\*  
 1 2 3 4
- 1.Part No.
  - 2.Material:  
(Blank):Nylon 66,UL94V-0  
GWT:Nylon 66,UL94V-0 GWT 750 °C
  - 3.Color:  
(blank):White  
BK:Black
  - 4.Finish:  
(Blank):Tin over Nickel  
G:Gold over Nickel

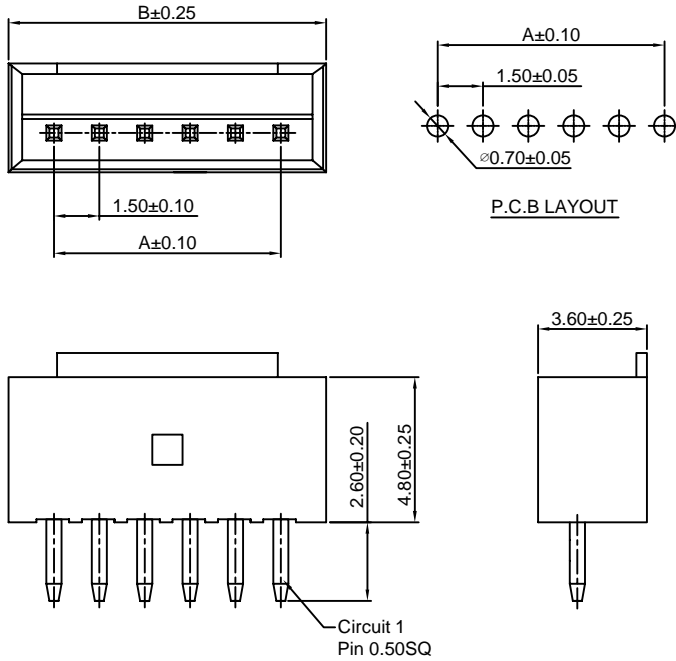

**Ordering Information & Dimensions:**

PART NO.	Dimensions	
	A	B
2P	1.50	4.50
3P	3.00	6.00
4P	4.50	7.50
5P	6.00	9.00
6P	7.50	10.50
7P	9.00	12.00
8P	10.50	13.50
9P	12.00	15.00
10P	13.50	16.50
11P	15.00	18.00
12P	16.50	19.50
13P	18.00	21.00
14P	19.50	22.50
15P	21.00	24.00

Unit: mm

### A1502WR-XP

1.50mm pitch 90° Wafer

**Reference Informations:**

- \*Material:Pin:Brass/Tin over Nickel  
Insulator:Nylon 66,UL94V-0
- \*Mates with CJT A1502H-XP series Housing
- \*Color:White

**Ordering Information:**

- A1502WR-XP - \*\*\* - \*\* - \*\*  
 1 2 3 4
- 1.Part No.
  - 2.Material:  
(Blank):Nylon 66,UL94V-0  
GWT:Nylon 66,UL94V-0 GWT 750 °C
  - 3.Color:  
(blank):White  
BK:Black
  - 4.Finish:  
(Blank):Tin over Nickel  
G:Gold over Nickel

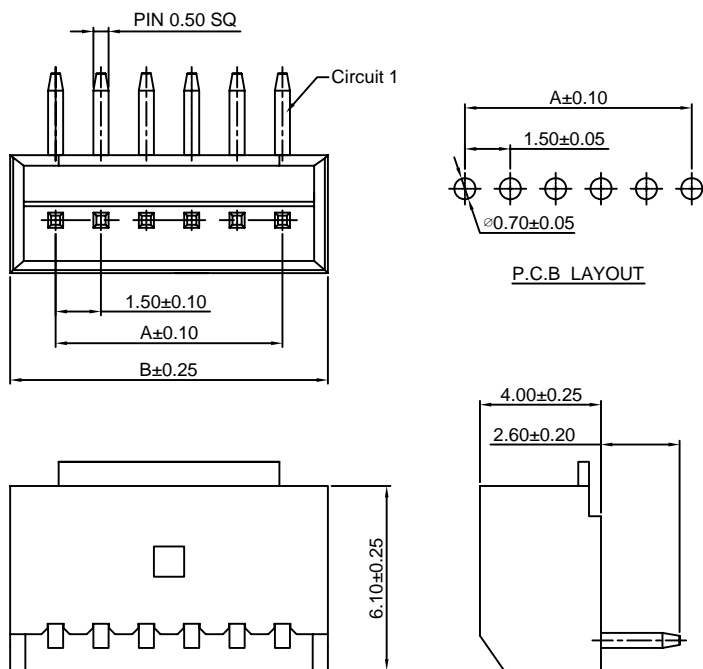

**Ordering Information & Dimensions:**

PART NO.	Dimensions	
	A	B
2P	1.50	4.50
3P	3.00	6.00
4P	4.50	7.50
5P	6.00	9.00
6P	7.50	10.50
7P	9.00	12.00
8P	10.50	13.50
9P	12.00	15.00
10P	13.50	16.50
11P	15.00	18.00
12P	16.50	19.50
13P	18.00	21.00
14P	19.50	22.50
15P	21.00	24.00

Unit: mm

### A1502WV-S-XP

1.50mm pitch 180° Wafer-SMT TYPE

**Reference Informations:**

- \*Material:Pin:Brass/Tin over Nickel  
Insulator:Nylon 6T,UL94V-0
- \*Mates with CJT A1502H-XP series Housing
- \*Color:Ivory

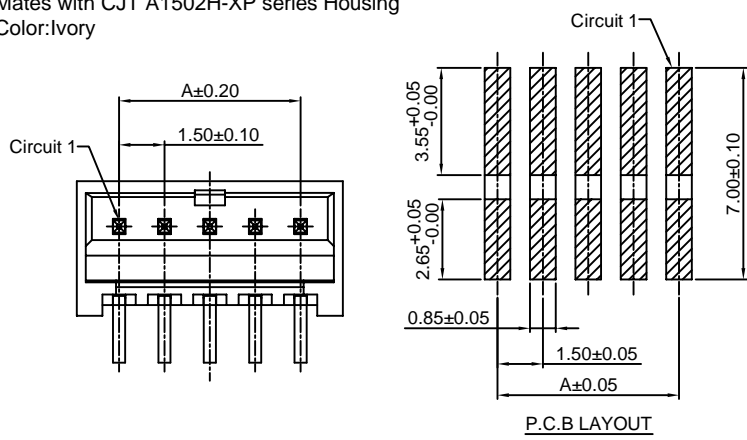

- Ordering Information:  
A1502WV-S-XP - \*\*\* - \*\* - \*\*  
1 2 3 4
- 1.Part No.
  - 2.Material:  
(Blank):Nylon 66,UL94V-0  
GWT:Nylon 66,UL94V-0,GWT 750°C
  - 3.Color:  
(blank):White  
BK:Black
  - 4.Finish:  
(Blank):Tin over Nickel  
G:Gold over Nickel

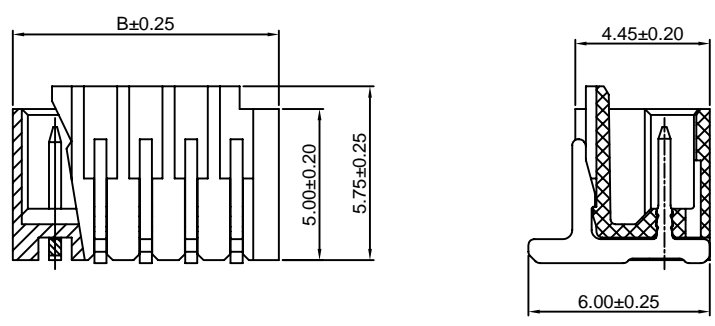
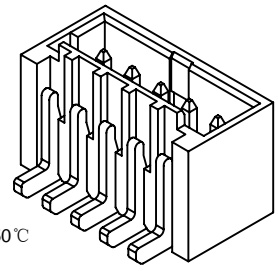

**Ordering Information & Dimensions:**

PART NO.	Dimensions	
	A	B
2P	1.50	4.30
3P	3.00	5.80
4P	4.50	7.30
5P	6.00	8.80
6P	7.50	10.30
7P	9.00	11.80
8P	10.50	13.30
9P	12.00	14.80
10P	13.50	16.30
11P	15.00	17.80
12P	16.50	19.30
13P	18.00	20.80
14P	19.50	22.30
15P	21.00	23.80

Unit: mm

### A1502WR-S-XP

1.50mm pitch 90° Wafer-SMT TYPE

**Reference Informations:**

- \*Material:Pin:Brass/Tin over Nickel  
Insulator:Nylon 6T,UL94V-0
- \*Mates with CJT A1502H-XP series Housing
- \*Color:Ivory

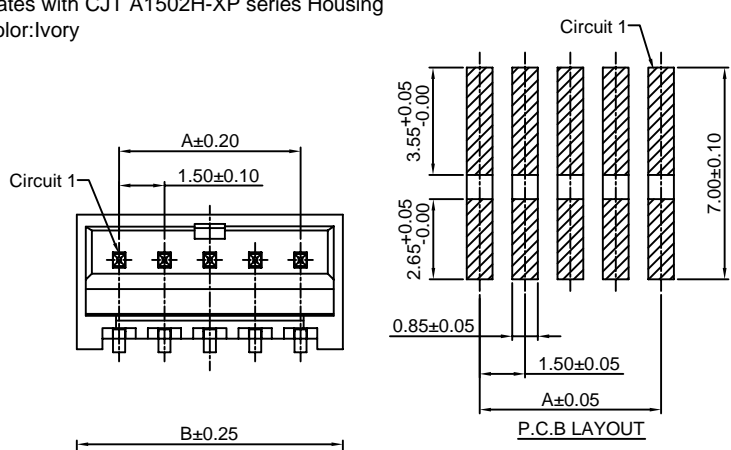

- Ordering Information:  
A1502WR-S-XP - \*\*\* - \*\* - \*\*  
1 2 3 4
- 1.Part No.
  - 2.Material:  
(Blank):Nylon 66,UL94V-0  
GWT:Nylon 66,UL94V-0,GWT 750°C
  - 3.Color:  
(blank):White  
BK:Black
  - 4.Finish:  
(Blank):Tin over Nickel  
G:Gold over Nickel

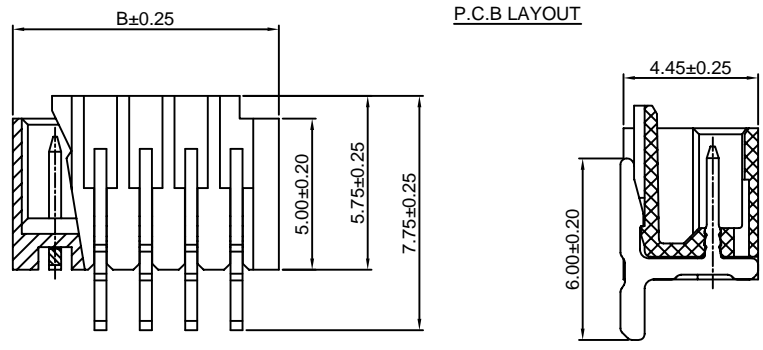
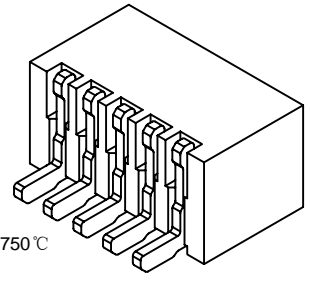

**Ordering Information & Dimensions:**

PART NO.	Dimensions	
	A	B
2P	1.50	4.30
3P	3.00	5.80
4P	4.50	7.30
5P	6.00	8.80
6P	7.50	10.30
7P	9.00	11.80
8P	10.50	13.30
9P	12.00	14.80
10P	13.50	16.30
11P	15.00	17.80
12P	16.50	19.30
13P	18.00	20.80
14P	19.50	22.30
15P	21.00	23.80

Unit: mm

### A1502WVA-XP

1.50mm pitch 180° Wafer

**Reference Informations:**

- \*Material:Pin:Brass/Tin over Nickel  
Insulator:Nylon 66,UL94V-0
- \*Mates with CJT A1502H-XP series Housing
- \*Color:Gray

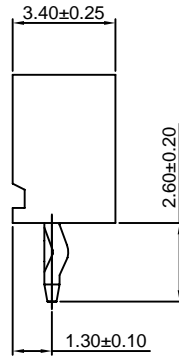
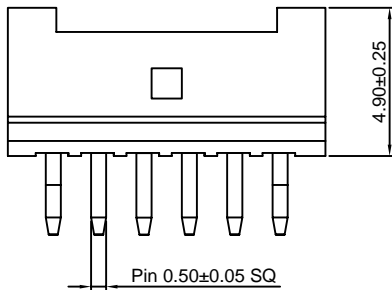
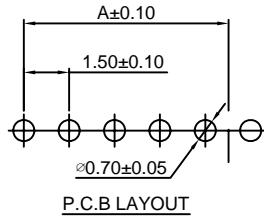
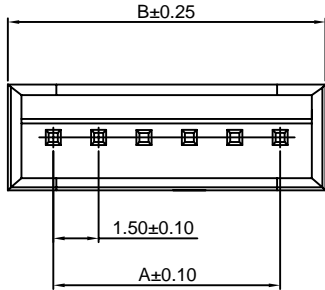

**Ordering Information:**

A1502WVA-XP - \*\*\* - \*\*  
1 2 3

- 1.Part No.
- 2.Material:  
(Blank):Nylon 66,UL94V-0  
GWT:Nylon 66,UL94V-0,GWT 750 °C
- 3.Finish:  
(Blank):Tin over Nickel  
G:Gold over Nickel

**Ordering Information & Dimensions:**

PART NO.	Dimensions	
	A	B
2P	1.50	4.50
3P	3.00	6.00
4P	4.50	7.50
5P	6.00	9.00
6P	7.50	10.50
7P	9.00	12.00
8P	10.50	13.50
9P	12.00	15.00
10P	13.50	16.50
11P	15.00	18.00
12P	16.50	19.50
13P	18.00	21.00
14P	19.50	22.50
15P	21.00	24.00

Unit: mm

### A1502WRA-XP

1.50mm pitch 90° Wafer

**Reference Informations:**

- \*Material:Pin:Brass/Tin over Nickel  
Insulator:Nylon 66,UL94V-0
- \*Mates with CJT A1502H-XP series Housing
- \*Color:Gray

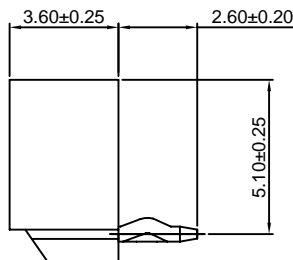
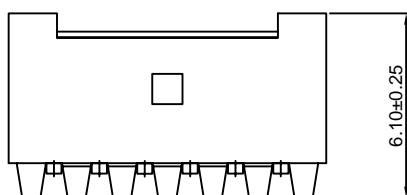
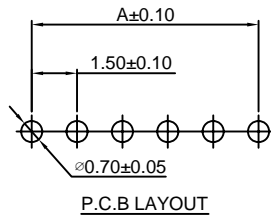
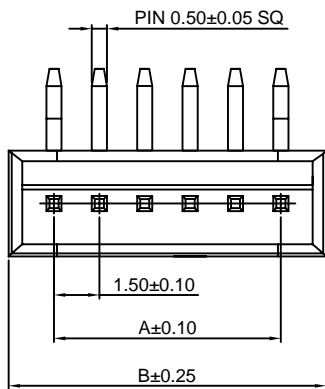

**Ordering Information:**

A1502WRA-XP - \*\*\* - \*\*  
1 2 3

- 1.Part No.
- 2.Material:  
(Blank):Nylon 66,UL94V-0  
GWT :Nylon 66,UL94V-0 GWT 750 °C
- 3.Finish:  
(Blank):Tin over Nickel  
G:Gold over Nickel

**Ordering Information & Dimensions:**

PART NO.	Dimensions	
	A	B
2P	1.50	4.50
3P	3.00	6.00
4P	4.50	7.50
5P	6.00	9.00
6P	7.50	10.50
7P	9.00	12.00
8P	10.50	13.50
9P	12.00	15.00
10P	13.50	16.50
11P	15.00	18.00
12P	16.50	19.50
13P	18.00	21.00
14P	19.50	22.50
15P	21.00	24.00

Unit: mm

# A1502WVA-IT-S-XP

1.50mm pitch thru board inverted SMT 180° Wafer

#### Reference Informations:

- \*Material: Pin: Brass/Tin over Nickel  
Solder Tabs: Brass/Tin over Nickel  
Insulator: LCP, UL94V-0
- \*Mates with CJT A1502HA-XP series Housing
- \*Color: Ivory

#### Odering Information:

A1502WVA-IT-S-XP - \*\*\* - \*\*  
1 2 3

1. Part No.
2. Material:  
(Blank): LCP, UL94V-0  
GWT: LCP, UL94V-0, GWT 750°C
3. Finish:  
(Blank): Tin over Nickel  
G: Gold over Nickel

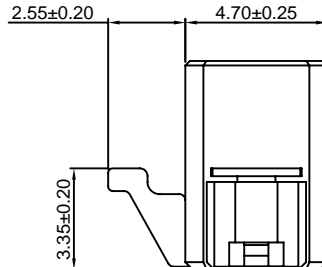
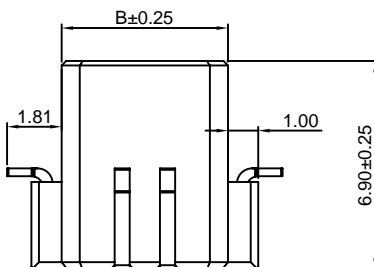
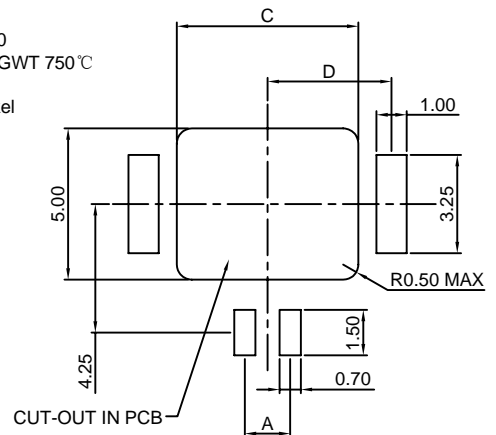
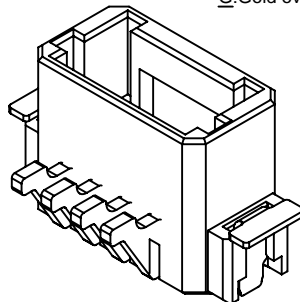
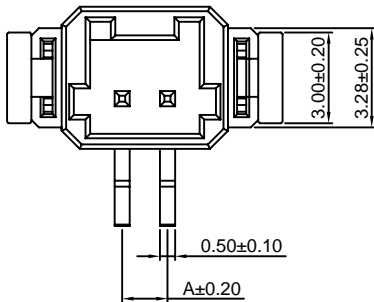

#### Ordering Information & Dimensions:

PART NO.	Dimensions			
	A	B	C	D
2P	1.50	5.50	6.00	4.10
3P	3.00	7.00	7.50	4.85
4P	4.50	8.50	9.00	5.60
5P	6.00	10.00	10.50	6.35
6P	7.50	11.50	12.00	7.10

Unit: mm

## X-ON Electronics

Largest Supplier of Electrical and Electronic Components

*Click to view similar products for [Headers & Wire Housings](#) category:*

*Click to view products by [Changjiang](#) manufacturer:*

Other Similar products are found below :

[57102-F02-18ULF](#) [58102-G61-06LF](#) [582553-1](#) [009176003701906](#) [0050291907](#) [02.125.8002.8](#) [609-3404](#) [61062-3](#) [622-0430](#) [622-3653LF](#)  
[63453-116](#) [636-1030](#) [636-1427](#) [636-3427](#) [636-4007](#) [641938-9](#) [65495-038](#) [65692-001LF](#) [65781-018](#) [65781-047](#) [65817-010LF](#) [65817-015LF](#)  
[66207-023LF](#) [67016-026LF](#) [67095-007LF](#) [68631-112](#) [68645-018](#) [68648-049](#) [699319-000](#) [M90C108951C](#) [70.362.1628.0](#) [70-4210](#) [70-4226B](#)  
[70-4853B](#) [707-5020](#) [707-5028](#) [71.350.2428.0](#) [71961-016LF](#) [733-134](#) [754199-000](#) [760-3052](#) [787-8014-00](#) [FCN-367T-T012/H](#)  
[80.063.4001.1](#) [800-90-001-10-001000](#) [801-43-002-10-013000](#) [801-43-006-10-002000](#) [803-41-018-10-001000](#) [803-43-014-20-001000](#)  
[803-43-024-10-001000](#)