

Specifications

- Current rating:3A AC,DC
- Voltage rating:350V AC,DC
- Temperature range:-40°C~+105°C
- Contact resistance:20mΩMax.
- Insulation resistance:1000MΩMin.
- Withstanding voltage:500V AC/minute
- *Compliant with RoHS and REACH*
- *Meet the HF/Halogen Free,need to customize*
- *Contact CJT for details*

Standards

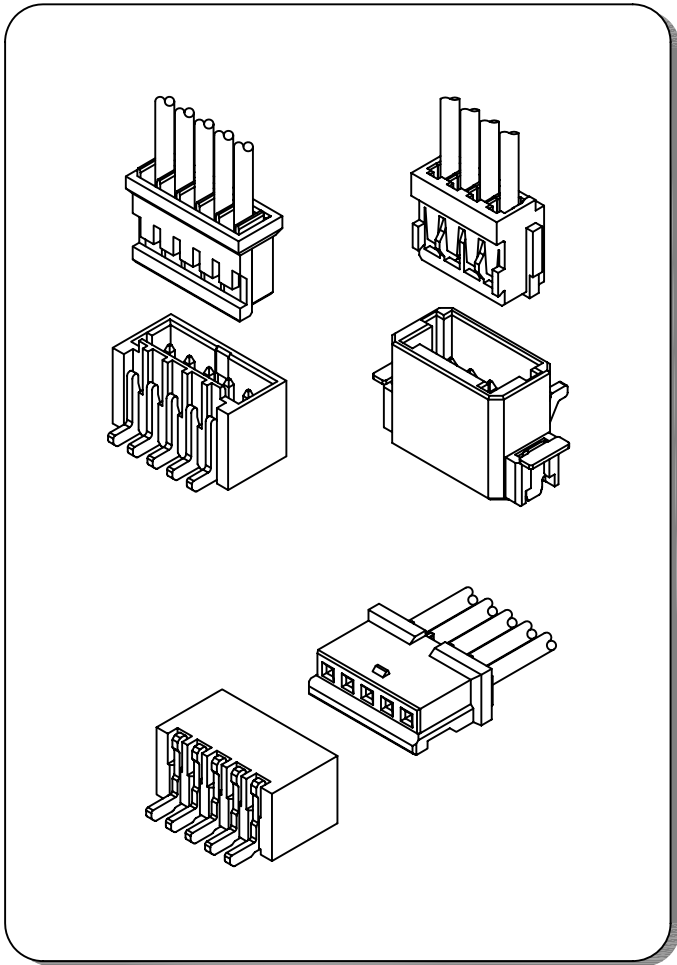

Assembly layout

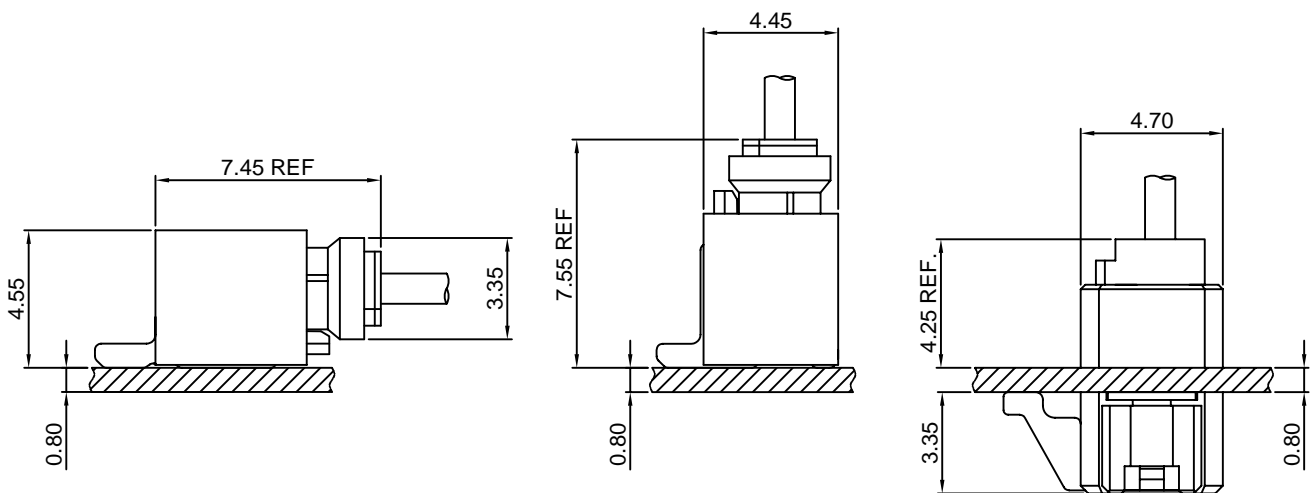

A1502-T

—1.50mm pitch Crimp Terminal—

Reference Informations:

*Used in CJT A1502 series Housing

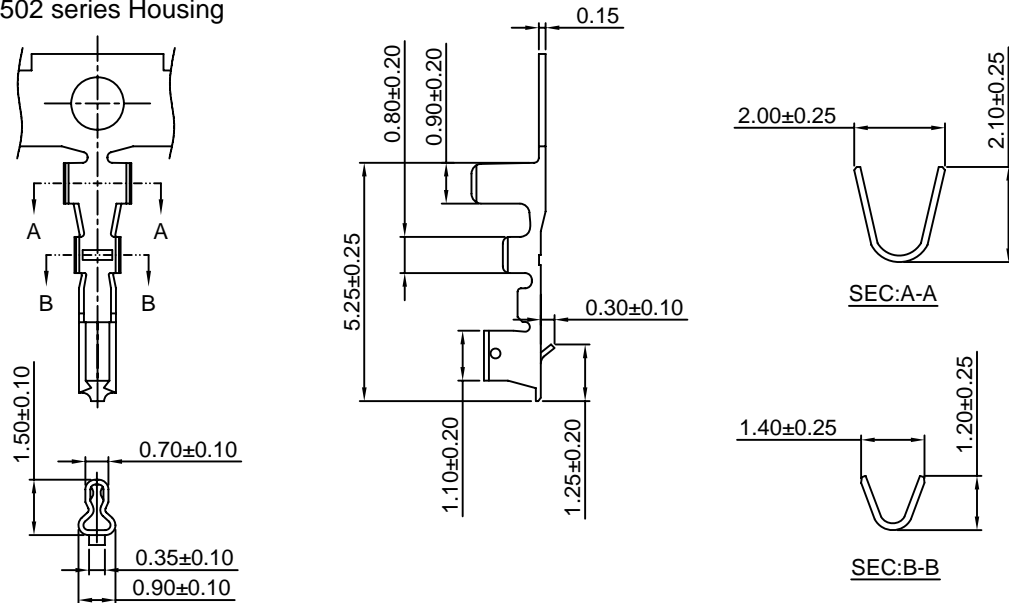

Ordering information & Specifications:

Unit:mm

Part NO.	Wire Range	Insulation O.D.	Material	Finish	Qty/reel
A1502-TP	AWG#24-#28	1.10mm(max)	Phosphor Bronze	Tin over Nickel	10,000 PCS
A1502-GP	AWG#24-#28	1.10mm(max)	Phosphor Bronze	Gold over Nickel	10,000 PCS

Optional Gold plating available but MOQ requested

A1502-T-A

—1.50mm pitch Crimp Terminal—

Reference Informations:

*Used in CJT A1502HA series Housing

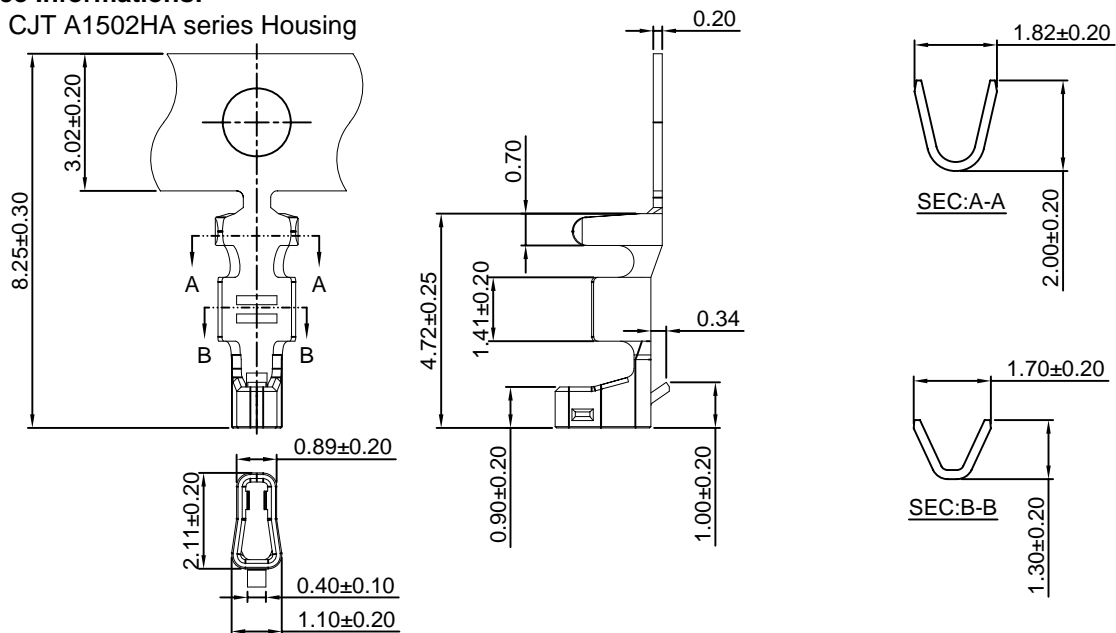

Ordering information & Specifications:

Unit:mm

Part NO.	Wire Range	Insulation O.D.	Material	Finish	Qty/reel
A1502-TP-A	AWG#24-#28	1.10mm(max)	Phosphor Bronze	Tin over Nickel	10,000 PCS
A1502-GP-A	AWG#24-#28	1.10mm(max)	Phosphor Bronze	Gold over Nickel	10,000 PCS

Optional Gold plating available but MOQ requested

A1502H

1.50mm pitch Housing

Reference Informations:

- *Material: Nylon 66, UL94V-0
- *Suitable CJT A1502 series Terminal
- *Mates with CJT A1502 series Wafer
- *Color: White

Ordering Information:

- A1502H-XP - **
 $\frac{1}{2}$
1. Part No.
 2. Color:
 (blank) - White
 BK - Black

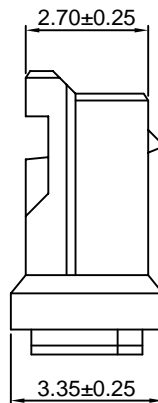
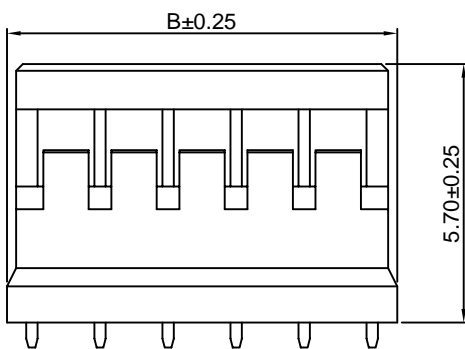
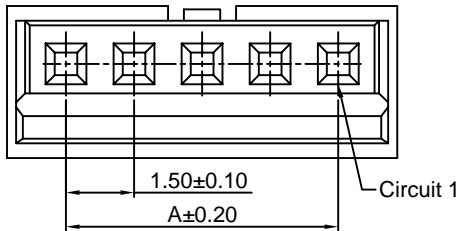
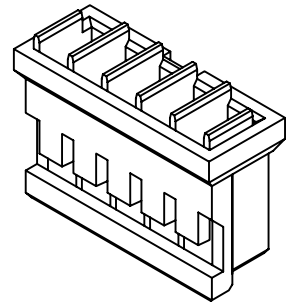

Ordering Information & Dimensions:

PART NO.	Dimensions	
	A	B
A1502H-2P	1.50	4.10
A1502H-3P	3.00	5.60
A1502H-4P	4.50	7.10
A1502H-5P	6.00	8.60
A1502H-6P	7.50	10.10
A1502H-7P	9.00	11.60
A1502H-8P	10.50	13.10
A1502H-9P	12.00	14.60
A1502H-10P	13.50	16.10
A1502H-11P	15.00	17.60
A1502H-12P	16.50	19.10
A1502H-13P	18.00	20.60
A1502H-14P	19.50	22.10
A1502H-15P	21.00	23.60

Unit: mm

A1502HA

1.50mm pitch Housing

Reference Informations:

- *Material: Nylon 66, UL94V-0
- *Suitable CJT A1502HA series Terminal
- *Mates with CJT A1502WVA-IT-S series Wafer
- *Color: White

Ordering Information:

- A1502HA-XP - **
 $\frac{1}{2}$
1. Part No.
 2. Color:
 (blank) - White
 BL - Blue

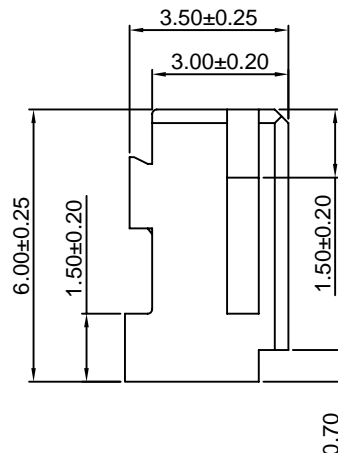
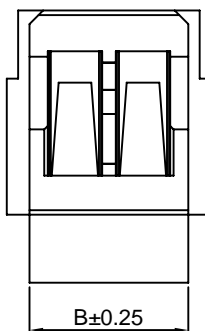
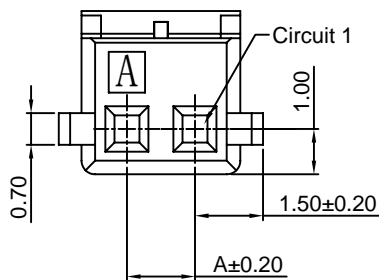
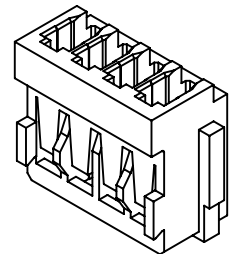

Ordering Information & Dimensions:

PART NO.	Dimensions	
	A	B
A1502HA-2P	1.50	3.50
A1502HA-3P	3.00	5.00
A1502HA-4P	4.50	6.50
A1502HA-5P	6.00	8.00
A1502HA-6P	7.50	9.50
A1502HA-7P	9.00	11.00
A1502HA-8P	10.50	12.50
A1502HA-9P	12.00	14.00
A1502HA-10P	13.50	15.50
A1502HA-11P	15.00	17.00
A1502HA-12P	16.50	18.50
A1502HA-13P	18.00	20.00
A1502HA-14P	19.50	21.50
A1502HA-15P	21.00	23.00
A1502HA-16P	22.50	24.50
A1502HA-17P	24.00	26.00
A1502HA-18P	25.50	27.50
A1502HA-19P	27.00	29.00
A1502HA-20P	28.50	30.50

Unit: mm

A1502WV

—1.50mm pitch 180° Wafer—

Reference Informations:

- *Material:Pin:Brass/Tin over Nicke
Insulator:Nylon 66,UL94V-0
- *Mates with CJT A1502 series Housing
- *Color:White

Odering Information:
A1502WV-XP - **
 1 2
 1.Part No.
 2.Color:
 (blank) - White
BK - Black

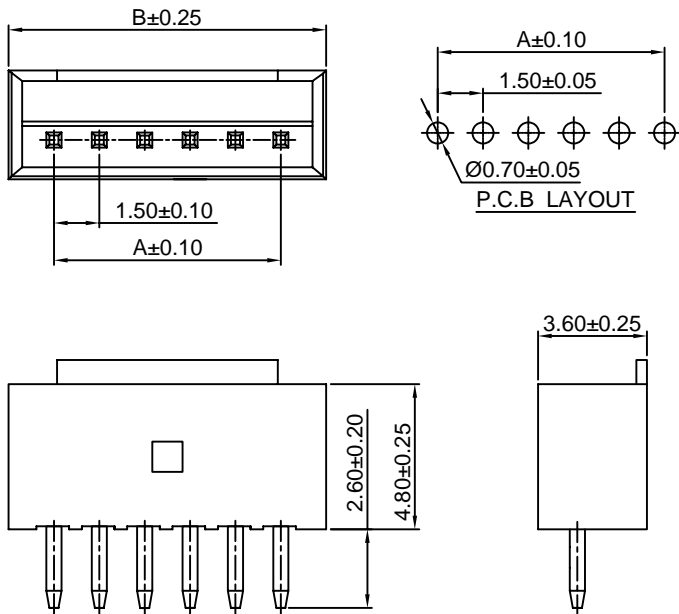

Ordering Information & Dimensions:

PART NO.	Dimensions	
	A	B
A1502WV-2P	1.50	4.50
A1502WV-3P	3.00	6.00
A1502WV-4P	4.50	7.50
A1502WV-5P	6.00	9.00
A1502WV-6P	7.50	10.50
A1502WV-7P	9.00	12.00
A1502WV-8P	10.50	13.50
A1502WV-9P	12.00	15.00
A1502WV-10P	13.50	16.50
A1502WV-11P	15.00	18.00
A1502WV-12P	16.50	19.50
A1502WV-13P	18.00	21.00
A1502WV-14P	19.50	22.50
A1502WV-15P	21.00	24.00

Unit: mm

A1502WR

—1.50mm pitch 90° Wafer—

Reference Informations:

- *Material:Pin:Brass/Tin over Nickel
Insulator:Nylon 66,UL94V-0
- *Mates with CJT A1502 series Housing
- *Color:White

Odering Information:
A1502WR-XP - **
 1 2
 1.Part No.
 2.Color:
 (blank) - White
BK - Black

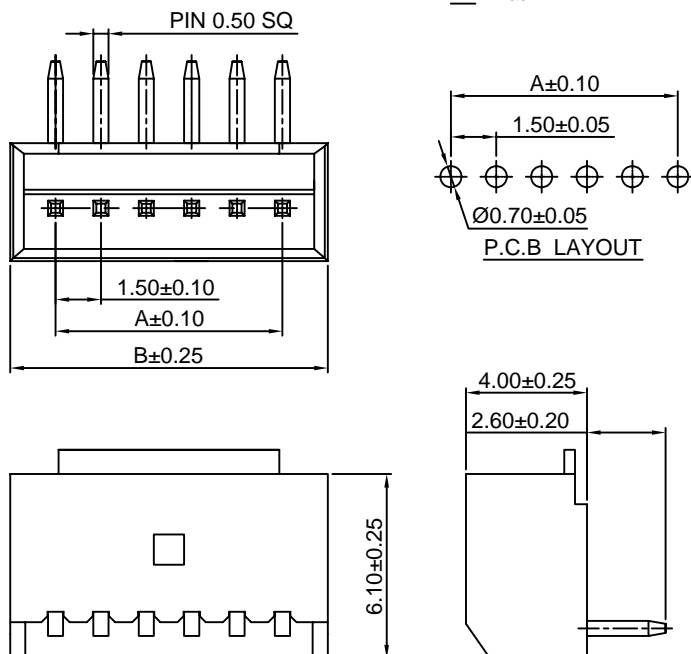

Ordering Information & Dimensions:

PART NO.	Dimensions	
	A	B
A1502WR-2P	1.50	4.50
A1502WR-3P	3.00	6.00
A1502WR-4P	4.50	7.50
A1502WR-5P	6.00	9.00
A1502WR-6P	7.50	10.50
A1502WR-7P	9.00	12.00
A1502WR-8P	10.50	13.50
A1502WR-9P	12.00	15.00
A1502WR-10P	13.50	16.50
A1502WR-11P	15.00	18.00
A1502WR-12P	16.50	19.50
A1502WR-13P	18.00	21.00
A1502WR-14P	19.50	22.50
A1502WR-15P	21.00	24.00

Unit: mm

A1502WV-S

1.50mm pitch 180° Wafer-SMT TYPE

Reference Informations:

- *Material: Pin: Brass/Tin over Nickel
Insulator: Nylon 6T, UL94V-0
- *Mates with CJT A1502 series Housing
- *Color: Ivory

Ordering Information:
A1502WV-S-XP - **
1
2

- 1. Part No.
- 2. Color:
(blank) - Ivory
BK - Black

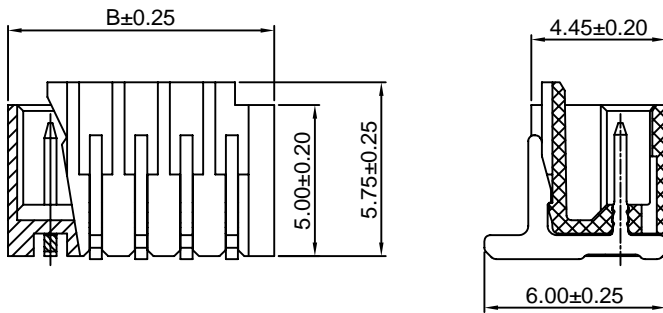
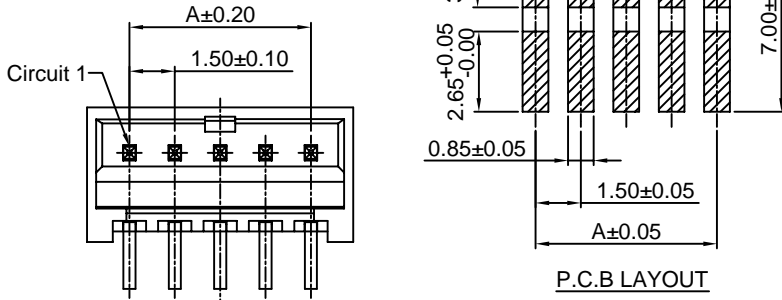
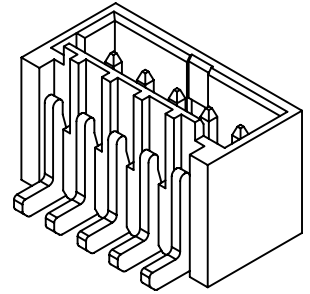

Ordering Information & Dimensions:

PART NO.	Dimensions	
	A	B
A1502WV-S-2P	1.50	4.30
A1502WV-S-3P	3.00	5.80
A1502WV-S-4P	4.50	7.30
A1502WV-S-5P	6.00	8.80
A1502WV-S-6P	7.50	10.30
A1502WV-S-7P	9.00	11.80
A1502WV-S-8P	10.50	13.30
A1502WV-S-9P	12.00	14.80
A1502WV-S-10P	13.50	16.30
A1502WV-S-11P	15.00	17.80
A1502WV-S-12P	16.50	19.30
A1502WV-S-13P	18.00	20.80
A1502WV-S-14P	19.50	22.30
A1502WV-S-15P	21.00	23.80

Unit: mm

A1502WR-S

1.50mm pitch 90° Wafer-SMT TYPE

Reference Informations:

- *Material: Pin: Brass/Tin over Nickel
Insulator: Nylon 6T, UL94V-0
- *Mates with CJT A1502 series Housing
- *Color: Ivory

Ordering Information:
A1502WR-S-XP - **
1
2

- 1. Part No.
- 2. Color:
(blank) - Ivory
BK - Black

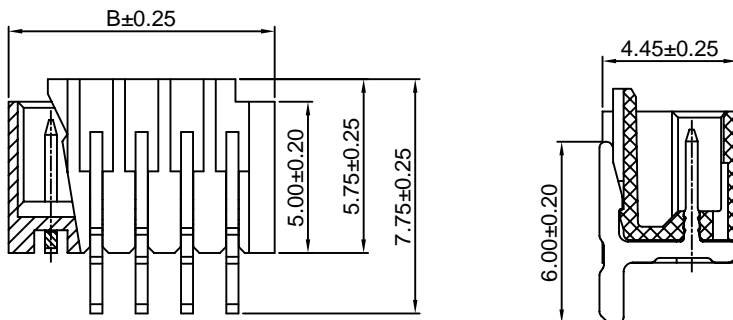
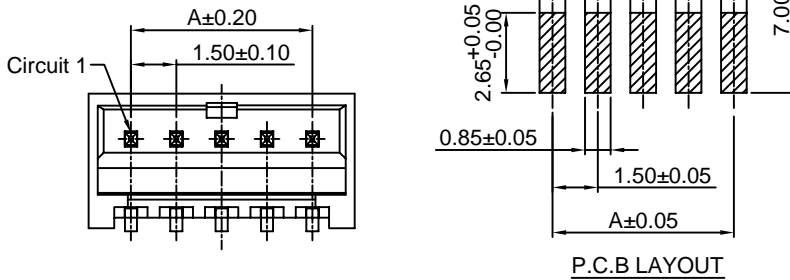
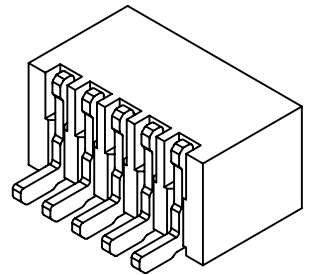

Ordering Information & Dimensions:

PART NO.	Dimensions	
	A	B
A1502WR-S-2P	1.50	4.30
A1502WR-S-3P	3.00	5.80
A1502WR-S-4P	4.50	7.30
A1502WR-S-5P	6.00	8.80
A1502WR-S-6P	7.50	10.30
A1502WR-S-7P	9.00	11.80
A1502WR-S-8P	10.50	13.30
A1502WR-S-9P	12.00	14.80
A1502WR-S-10P	13.50	16.30
A1502WR-S-11P	15.00	17.80
A1502WR-S-12P	16.50	19.30
A1502WR-S-13P	18.00	20.80
A1502WR-S-14P	19.50	22.30
A1502WR-S-15P	21.00	23.80

Unit: mm

A1502WVA-IT-S

1.50mm pitch thru board inverted SMT 180° Wafer

Reference Informations:

- *Material: Pin: Brass/Tin over Nickel
Solder Tabs: Brass/Tin over Nickel
Insulator: LCP, UL94V-0
- *Mates with CJT A1502HA series Housing
- *Color: Ivory

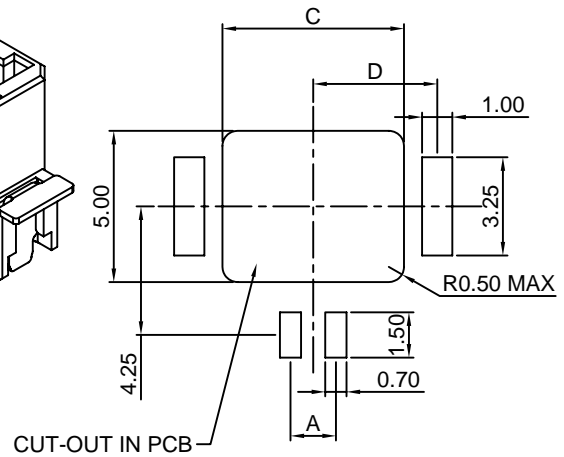
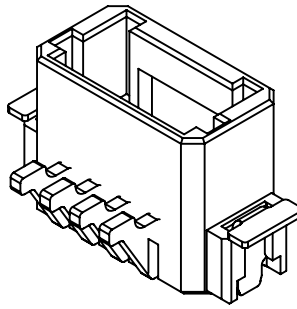
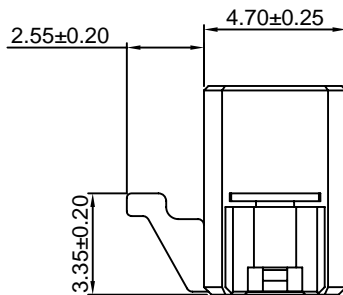
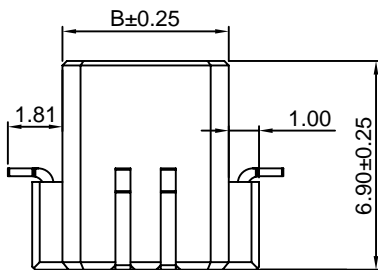
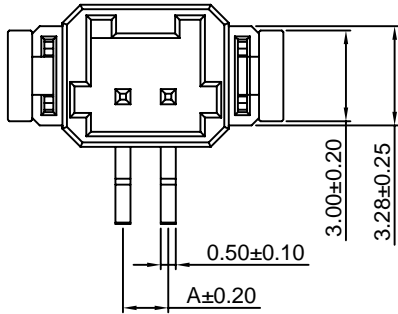

Ordering Information & Dimensions:

PART NO.	Dimensions			
	A	B	C	D
A1502WVA-IT-S-2P	1.50	5.50	6.00	4.10
A1502WVA-IT-S-3P	3.00	7.00	7.50	4.85
A1502WVA-IT-S-4P	4.50	8.50	9.00	5.60
A1502WVA-IT-S-5P	6.00	10.00	10.50	6.35
A1502WVA-IT-S-6P	7.50	11.50	12.00	7.10

Unit: mm

X-ON Electronics

Largest Supplier of Electrical and Electronic Components

Click to view similar products for [Headers & Wire Housings](#) category:

Click to view products by [Changjiang](#) manufacturer:

Other Similar products are found below :

[57102-F02-18ULF](#) [58102-G61-06LF](#) [582553-1](#) [009176003701906](#) [0050291907](#) [02.125.8002.8](#) [609-3404](#) [61062-3](#) [622-0430](#) [622-3653LF](#)
[63453-116](#) [636-1030](#) [636-1427](#) [636-3427](#) [636-4007](#) [641938-9](#) [65495-038](#) [65692-001LF](#) [65781-018](#) [65781-047](#) [65817-010LF](#) [65817-015LF](#)
[66207-023LF](#) [67016-026LF](#) [67095-007LF](#) [68631-112](#) [68645-018](#) [68648-049](#) [699319-000](#) [M90C108951C](#) [70.362.1628.0](#) [70-4210](#) [70-4226B](#)
[70-4853B](#) [707-5020](#) [707-5028](#) [71.350.2428.0](#) [71961-016LF](#) [733-134](#) [754199-000](#) [760-3052](#) [787-8014-00](#) [FCN-367T-T012/H](#)
[80.063.4001.1](#) [800-90-001-10-001000](#) [801-43-002-10-013000](#) [801-43-006-10-002000](#) [803-41-018-10-001000](#) [803-43-014-20-001000](#)
[803-43-024-10-001000](#)